



ABN 43 064 478 842

231 Osborne Avenue Clayton South, VIC 3169
PO Box 1548, Clayton South, VIC 3169
t 03 9265 7400 f 03 9558 0875
freecall 1800 680 680
www.tmgtestequipment.com.au

Test & Measurement

- > sales
- > rentals
- > calibration
- > repair
- > disposal

Complimentary Reference Material

This PDF has been made available as a complimentary service for you to assist in evaluating this model for your testing requirements.

TMG offers a wide range of test equipment solutions, from renting short to long term, buying refurbished and purchasing new. Financing options, such as Financial Rental, and Leasing are also available on application.

TMG will assist if you are unsure whether this model will suit your requirements.

Call TMG if you need to organise repair and/or calibrate your unit.

If you click on the "Click-to-Call" logo below, you can call us for FREE!

TMG Corporate Website

TMG Products Website



Click-to-Call
TMG Now



Product Lifecycle Management System

Disclaimer:

All trademarks appearing within this PDF are trademarks of their respective owners.



DSP-4000 Series

CableAnalyzer™

Users Manual

LIMITED WARRANTY & LIMITATION OF LIABILITY

Each Fluke Networks product is warranted to be free from defects in material and workmanship under normal use and service. The warranty period is one year and begins on the date of purchase. Parts, accessories, product repairs and services are warranted for 90 days. This warranty extends only to the original buyer or end-user customer of a Fluke Networks authorized reseller, and does not apply to disposable batteries, cable connector tabs, cable insulation-displacement connectors, or to any product which, in Fluke Networks' opinion, has been misused, altered, neglected, contaminated, or damaged by accident or abnormal conditions of operation or handling. Fluke Networks warrants that software will operate substantially in accordance with its functional specifications for 90 days and that it has been properly recorded on non-defective media. Fluke Networks does not warrant that software will be error free or operate without interruption.

Fluke Networks authorized resellers shall extend this warranty on new and unused products to end-user customers only but have no authority to extend a greater or different warranty on behalf of Fluke Networks. Warranty support is available only if product is purchased through a Fluke Networks authorized sales outlet or Buyer has paid the applicable international price. Fluke Networks reserves the right to invoice Buyer for importation costs of repair/replacement parts when product purchased in one country is submitted for repair in another country.

Fluke Networks' warranty obligation is limited, at Fluke Networks' option, to refund of the purchase price, free of charge repair, or replacement of a defective product which is returned to a Fluke Networks authorized service center within the warranty period.

To obtain warranty service, contact your nearest Fluke Networks authorized service center to obtain return authorization information, then send the product to that service center, with a description of the difficulty, postage and insurance prepaid (FOB Destination). Fluke Networks assumes no risk for damage in transit. Following warranty repair, the product will be returned to Buyer, transportation prepaid (FOB Destination). If Fluke Networks determines that failure was caused by neglect, misuse, contamination, alteration, accident or abnormal condition of operation or handling, or normal wear and tear of mechanical components, Fluke Networks will provide an estimate of repair costs and obtain authorization before commencing the work. Following repair, the product will be returned to the Buyer transportation prepaid and the Buyer will be billed for the repair and return transportation charges (FOB Shipping Point).

THIS WARRANTY IS BUYER'S SOLE AND EXCLUSIVE REMEDY AND IS IN LIEU OF ALL OTHER WARRANTIES, EXPRESS OR IMPLIED, INCLUDING BUT NOT LIMITED TO ANY IMPLIED WARRANTY OF MERCHANTABILITY OR FITNESS FOR A PARTICULAR PURPOSE. FLUKE NETWORKS SHALL NOT BE LIABLE FOR ANY SPECIAL, INDIRECT, INCIDENTAL OR CONSEQUENTIAL DAMAGES OR LOSSES, INCLUDING LOSS OF DATA, ARISING FROM ANY CAUSE OR THEORY.

Since some countries or states do not allow limitation of the term of an implied warranty, or exclusion or limitation of incidental or consequential damages, the limitations and exclusions of this warranty may not apply to every buyer. If any provision of this Warranty is held invalid or unenforceable by a court or other decision-maker of competent jurisdiction, such holding will not affect the validity or enforceability of any other provision.

Fluke Networks, Inc.
PO Box 777
Everett, WA 98206-0777
USA

Table of Contents

Chapter		Page
1	Introduction	1-1
	Contacting Fluke Networks.....	1-1
	Registration	1-2
	Overview of Features	1-2
	Standard Accessories.....	1-4
	Using This Manual.....	1-6
2	Getting Started	2-1
	Read First: Safety and Operational Information.....	2-1
	Quick Start	2-4
	Powering the Test Tool.....	2-4
	Using the Menus	2-4
	Using the Link Interface Adapters	2-5
	Formatting the Memory Card (DSP-4100/4300)	2-6
	Quick Configuration.....	2-8
	Results within Accuracy Range	2-9
	Autotest on Twisted Pair Cabling	2-10
	Saving Test Reports	2-11
	Using the Talk Mode.....	2-15
	Autotest on Coaxial Cabling	2-16
	Main Unit Features.....	2-18
	Remote Features	2-21
	Link Interface Adapter Features	2-23
	Permanent Link Interface Adapters (DSP-4000PL/4300).....	2-24
	Changing the Personality Module (DSP-4000PL/4300)	2-25
	Strap and Bail.....	2-26
	Rotary Switch.....	2-26
	Off.....	2-26
	Autotest	2-27
	Single Test	2-28
	Monitor	2-29

Setup.....	2-29
Print.....	2-30
Special Functions	2-30
Turning On the Test Tool.....	2-31
Selecting a Language for Displays and Reports.....	2-31
Performing a Self-Test	2-32
Overvoltage Test	2-32
Noise Test	2-33
Configuring the Test Tool.....	2-33
Controlling the Backlight.....	2-33
Adjusting the Display Contrast	2-34
Selecting a Power Line Filter Frequency	2-34
Selecting a Test Standard and Cable Type.....	2-35
Editing the Report Identification.....	2-36
Setting Up Cable IDs.....	2-37
Viewing the Cable ID Configuration and Memory Status	2-40
Storing Plot Data with Saved Autotest Results (DSP-4100/4300).....	2-40
Selecting a Length Unit.....	2-40
Selecting a Numeric Format.....	2-41
Setting the Date and Time.....	2-41
Setting the Power-Down Timer.....	2-42
Enabling or Disabling the Audible Tones	2-42
Remote Lights, Messages, and Audible Tones.....	2-43
Remote Communication Error	2-43
Battery Status	2-44
Battery Status Display	2-45
Conditioning the Battery	2-45
3 Autotest	3-1
Autotest Softkeys	3-1
Autotest on Twisted Pair Cabling.....	3-2
Link Performance Grade Result (Headroom).....	3-6
Worst Margin and Worst Value Results.....	3-6
Automatic Diagnostics	3-7
Autotest Results for Twisted Pair Cabling	3-8
Wire Map Test.....	3-8
Resistance.....	3-10
Length	3-10
Propagation Delay and Delay Skew	3-11
Characteristic Impedance	3-11
Attenuation (Insertion Loss).....	3-12
NEXT Test	3-14
NEXT@REMOTE.....	3-16
ELFEXT Test.....	3-16
ACR	3-19
ACR@REMOTE	3-21

Return Loss (RL)	3-21
RL@REMOTE	3-23
PSNEXT (Power Sum NEXT) and PSNEXT@REMOTE	3-23
PSELFEXT (Power Sum ELFEXT)	3-23
PSACR (Power Sum ACR) and PSACR@REMOTE	3-23
Autotest on Coaxial Cabling	3-23
Autotest Results for Coaxial Cabling	3-25
Characteristic Impedance	3-25
Resistance.....	3-26
Length	3-26
Anomaly.....	3-26
Saving Autotest Results	3-27
Saving Results with Auto Sequence Disabled	3-27
Saving Results with Auto Sequence Enabled.....	3-29
Saving Results with Downloaded Cable IDs (DSP-4300)	3-30
Changing the Cable ID for a Saved Autotest Report	3-30
If Memory is Full	3-31
Saving Results to Internal Memory (DSP-4300)	3-31
The Autotest Report	3-32
4 Running Individual Tests	4-1
Single Tests for Twisted Pair Cabling.....	4-1
Scanning Function.....	4-2
When to Use a Remote Unit.....	4-2
Running a Single Test on Twisted Pair Cabling.....	4-4
The HDTDX Analyzer	4-6
Running the HDTDX Analyzer.....	4-6
HDTDX Analyzer Results	4-7
HDTDX Analyzer Plot.....	4-8
The HDTDR Test.....	4-9
How to Terminate the Cable	4-9
Running the HDTDR Test on Twisted Pair Cabling.....	4-11
Running the HDTDR Test on Coaxial Cabling.....	4-11
HDTDR Results Screen	4-12
HDTDR Plot Screen.....	4-12
Single Test Results for Twisted Pair Cabling.....	4-14
Wire Map	4-14
Length	4-14
NEXT and NEXT@REMOTE.....	4-14
ELFEXT	4-14
Impedance	4-15
Attenuation (Insertion Loss)	4-15
Resistance.....	4-15
Return Loss (RL) and RL@REMOTE.....	4-15
Power Sum NEXT and Power Sum NEXT@REMOTE.....	4-15
Power Sum ELFEXT	4-15

Single Tests for Coaxial Cabling.....	4-16
Running a Single Test on Coaxial Cabling	4-16
Single Test Results for Coaxial Cabling	4-18
Monitoring Network Activity.....	4-19
Identifying Hub Port Connections.....	4-22
Monitoring Impulse Noise.....	4-22
Changing the Impulse Noise Threshold	4-23
Running the Impulse Noise Test	4-23
Noise Test Results.....	4-25
Determining Hub Port Capabilities	4-26
Using the Tone Generator	4-26
5 Viewing and Printing Saved Reports.....	5-1
Viewing, Renaming, and Deleting Test Reports	5-1
Printing Test Reports.....	5-2
Configuring the Serial Port	5-3
Printer Interface Cable	5-3
Printing.....	5-4
If the Printer Does Not Respond	5-6
Viewing and Printing Reports from a PC.....	5-6
6 Calibrations and Custom Test Standards.....	6-1
Calibrating the Test Tool.....	6-1
Calibrating the Permanent Link Adapters	6-3
NVP Calibration.....	6-3
Configuring a Custom Test	6-4
7 Basic Cabling Testing.....	7-1
LAN Cable Construction.....	7-1
Twisted Pair Cable	7-2
Coaxial Cable.....	7-4
Basic Link Connections.....	7-5
Channel Connections.....	7-6
Permanent Link Connections	7-7
Attenuation (Insertion Loss).....	7-8
Noise	7-9
Characteristic Impedance	7-10
Minimizing Impedance Discontinuities.....	7-11
Crosstalk.....	7-11
NEXT	7-12
FEXT and ELFEXT	7-12
Locating NEXT and ELFEXT Problems.....	7-14
Split Pairs and NEXT	7-16
Minimizing Crosstalk.....	7-17
Power Sum Values	7-17
Propagation Delay and Delay Skew	7-18

Nominal Velocity of Propagation (NVP)	7-19
NVP and Length Measurements	7-20
NVP Calibration.....	7-20
High-Definition Time Domain Reflectometry (HDTDR).....	7-20
Reflections from Opens.....	7-21
Reflections from Shorts.....	7-22
Reflections from Other Anomalies	7-22
Cable Termination.....	7-23
Interpreting the HDTDR Plot.....	7-23
ACR	7-24
RL.....	7-26
Troubleshooting Basics	7-27
8 Maintenance and Specifications	8-1
Getting Software Upgrades	8-1
Maintenance	8-1
Cleaning and Storage	8-2
Replacing the NiMH Battery Pack.....	8-2
Internal Lithium Backup Battery.....	8-3
If the Test Tool Fails	8-3
Service Center Repair	8-3
Replacement Parts.....	8-5
Options and Accessories	8-6
Specifications	8-8
Calculated Measurement Accuracy.....	8-8
Traceable Calibration Period.....	8-8
Self-Calibration Period	8-8
Compatibility with Remotes and Link Interface Adapters.....	8-9
Standard Link Interface Adapters	8-9
Cable Types Tested.....	8-10
Test Standards	8-11
Time for Autotest	8-11
Length	8-12
Propagation Delay.....	8-12
Delay Skew	8-12
DC Loop Resistance Test.....	8-12
Measurement Accuracy as Specified in Relevant Standards.....	8-13
Typical Measurement Accuracies	8-14
HDTDX™ Analyzer Specifications for Cables <100 m (328 ft).....	8-18
HDTDR™ Specifications for Cables <100 m (328 ft)	8-18
Impulse Noise	8-18
Characteristic Impedance	8-18
LAN Traffic Monitoring	8-19
Tone Generator	8-19
Serial Interface	8-19
PC Interface Cable	8-20

Power	8-21
Environmental Requirements	8-21
Electromagnetic Compatibility.....	8-21
Input Ratings	8-22
Certification and Compliance.....	8-23
Test Results Memory for the DSP-4100/4300	8-23
Test Results Memory for the DSP-4000	8-24
Dimensions.....	8-24
Weight.....	8-24
Display	8-24
Warranty.....	8-24

Appendices

A Tests Supported by LIAs.....	A-1
B Glossary.....	B-1

Index

List of Tables

Table	Title	Page
2-1.	International Electrical Symbols	2-1
2-2.	Key Functions for the Menu System	2-4
2-3.	Quick Configuration Settings	2-8
2-4.	Main Unit Features	2-19
2-5.	Remote Connectors and Features	2-22
2-6.	Status Indications from the Remote	2-43
2-7.	Battery Status Messages	2-44
3-1.	Wire Map Displays	3-8
3-2.	Items on the Attenuation Results Screen	3-12
3-3.	Items on the NEXT Results Screen	3-14
3-4.	Items on the ELFEXT Results Screen	3-17
3-5.	Items on the ACR Results Screen	3-19
3-6.	Items on the RL Results Screen	3-21
4-1.	Remote Requirements for Cable Tests	4-3
4-2.	Items on the HDTDX Analyzer Results Screen	4-7
4-3.	Effects of Termination on HDTDR Results	4-10
4-4.	Items on an HDTDR Results Screen (Twisted Pair Results)	4-12
4-5.	Items on the Traffic Monitor Screen	4-21
4-6.	Items on the Noise Monitor Screen	4-25
7-1.	Identifying Cabling Faults	7-28
8-1.	Troubleshooting the Test Tool	8-4
8-2.	Replacement Parts	8-5
8-3.	Options and Accessories	8-6
8-4.	Performance Parameters	8-13
8-5.	PC Interface Cable Connections	8-20
8-6.	9-to 25-pin Adapter	8-20
A-1.	Tests Supported by Standard Link Interface Adapters	A-2

List of Figures

Figure	Title	Page
1-1.	Standard Accessories.....	1-5
2-1.	Attaching a Link Interface Adapter.....	2-6
2-2.	Inserting and Removing the Memory card.....	2-7
2-3.	The Asterisk and Test Tool Accuracy.....	2-9
2-4.	Typical Test Connections for a Basic Link.....	2-12
2-5.	Typical Test Connections for a Channel.....	2-13
2-6.	Typical Test Connections for a Permanent Link.....	2-14
2-7.	Autotest Connections for Coaxial Cabling.....	2-17
2-8.	Main Unit Features.....	2-18
2-9.	Remote Features.....	2-21
2-10.	Link Interface Adapter Features.....	2-23
2-11.	Permanent Link Adapter Handling Guidelines.....	2-24
2-12.	Changing the Personality Module.....	2-25
2-13.	Attaching the Strap and Opening the Bail.....	2-26
3-1.	Typical Test Connections for a Basic Link.....	3-3
3-2.	Typical Test Connections for a Channel.....	3-4
3-3.	Typical Test Connections for a Permanent Link.....	3-5
3-4.	Examples of Automatic Diagnostics Displays.....	3-7
3-5.	The Attenuation Plot Screen.....	3-13
3-6.	The NEXT Plot Screen.....	3-15
3-7.	The ELFEXT Plot Screen.....	3-18
3-8.	The ACR Plot Screen.....	3-20
3-9.	The RL Plot Screen.....	3-22
3-10.	Autotest Connections for Coaxial Cabling.....	3-24
3-11.	Saving Autotest Results (Auto Increment and Auto Sequence Disabled).....	3-28
3-12.	Autotest Report in Tabular Format.....	3-33
3-13.	Autotest Report in Graphical Format.....	3-34
4-1.	Single Test Connections for Twisted Pair Cabling.....	4-5
4-2.	Example of an HDTDX Analyzer Plot for a Good Twisted Pair Cable Run.....	4-8
4-3.	Example of an HDTDR Plot (Twisted Pair Results).....	4-13
4-4.	Single Test Connections for Coaxial Cabling.....	4-17
4-5.	Connections for Monitoring Network Traffic.....	4-19

4-6.	Typical Connections for Monitoring Impulse Noise	4-24
5-1.	Connections for Printing Test Reports	5-4
6-1.	Connections for Self-Calibration	6-2
7-1.	Twisted Pair Cable Construction	7-2
7-2.	EIA/TIA RJ45 Connections	7-3
7-3.	Coaxial Cable Construction.....	7-4
7-4.	Basic Link Test Connections.....	7-5
7-5.	Channel Test Connections.....	7-6
7-6.	Permanent Link Test Connections.....	7-7
7-7.	Attenuation of a Signal.....	7-8
7-8.	Sources of Electrical Noise	7-9
7-9.	How FEXT Signals are All Equally Attenuated.....	7-13
7-10.	An HDTDIX Analyzer Plot	7-14
7-11.	Split Pair Wiring.....	7-16
7-12.	How NVP is Calculated	7-19
7-13.	Signals Reflected from an Open, Shorted, and Terminated Cable	7-21
7-14.	Example of an HDTDR Plot.....	7-23
7-15.	A Plot of NEXT, Attenuation, and the Resulting ACR.....	7-25
8-1.	Removing the NiMH Battery Pack.....	8-2
8-2.	Attenuation (Insertion Loss) Measurement Accuracy for Channel	8-15
8-3.	Pair-to-Pair NEXT Measurement Accuracy for a Channel	8-15
8-4.	PSNEXT Measurement Accuracy for Channel	8-16
8-5.	Pair-to-Pair ELFEXT Measurement Accuracy for Channel.....	8-16
8-6.	PSELFEXT Measurement Accuracy for Channel.....	8-17
8-7.	Return Loss Measurement Accuracy for Channel.....	8-17
8-8.	Operating Environment Specifications.....	8-22

Chapter 1

Introduction

Chapter 1 provides the following information:

- Contact information for Fluke Networks
- Features of the DSP-4000 Series test tools.
- A list of equipment included with the test tool.
- A guide to using this manual.

Contacting Fluke Networks

Visit the Fluke Networks web site at www.flukenetworks.com.

Send email to **support@flukenetworks.com**

To order accessories or get the location of the nearest Fluke Networks distributor or service center, call:

- USA: 1-888-99-FLUKE (1-888-993-5853)
- Canada: 1-800-363-5853
- Europe: +44-1923-281-300
- Beijing: 86 (10) 6512-3435
- Japan: +81-3-3434-0181
- Singapore: +65-6738-5655
- Anywhere in the world: +1-425-446-4519

For operating assistance in the USA, call 1-800-283-5853.

Registration

Registering your product with Fluke Networks gives you access to valuable information on product updates, troubleshooting tips, and other support services. To register, fill out and return the postage-paid card provided, or fill out the online registration form on the Fluke Networks website.

Overview of Features

Note

New features may be available with software upgrades. Visit the Fluke Networks website at www.flukenetworks.com or contact your Fluke Networks representative for information on upgrades.

The Fluke Networks DSP-4000 Series CableAnalyzers™ (hereafter referred to as “the test tool”) are hand-held instruments used to certify, test, and troubleshoot coaxial and twisted pair cabling in local area network (LAN) installations. The test tool combines test pulses with digital signal processing to provide fast, accurate results and advanced testing capabilities up to 350 MHz.

The test tool includes the following features:

- Certifies LAN basic link, permanent link, and channel configurations to IEEE, ANSI, TIA, and ISO/IEC standards.
- Optional Fiber Test Adapters lets you certify LAN basic fiber links to TIA/EIA and ISO/IEC standards.
- Presents test options and results in a simple menu system.
- Presents displays and printed reports in English, German, French, Spanish, Portuguese, Italian, or Japanese.
- Runs all critical tests automatically. Diagnostic routine helps you identify and locate faults.
- Produces 2-way Autotest results.
- “Talk” feature allows 2-way voice communication between the main and remote units over twisted pair cable or over fiber using a Fiber Test Adapter.
- Model DSP-4000 stores at least 500 text-based test reports in nonvolatile memory. Model DSP-4100 stores at least 250 graphical test reports on a removable memory card. Model DSP-4300 stores at least 250 graphical test reports on a removable memory card or in internal memory.

- Sends stored test reports to a host computer or directly to a serial printer.
- Includes a stored library of common test standards and cable types for copper and fiber installations. Flash EPROM accepts test standard and software upgrades.
- Allows for configuration of custom test standards.
- High-Definition Time Domain Crosstalk (HDTDX™) analyzer locates the position of crosstalk problems in a link.
- High-Definition Time Domain Reflectometry (HDTDR™) analyzer locates the position of return loss problems in a link.
- Produces plots of NEXT, ELFEXT, PSNEXT, PSELFEXT, attenuation, ACR, PSACR, and RL. Shows NEXT, ELFEXT, PSNEXT, PSELFEXT, attenuation, ACR, and PSACR results up to 350 MHz. Gives remote results for NEXT, PSNEXT, ACR, and RL.
- DSP-LIA013 adapters let you monitor network traffic on 10/100BASE-TX Ethernet systems, monitors impulse noise on twisted pair cable, helps you identify hub port connections, and determines which standards are supported by a hub port connection. (Standard with DSP-4300; optional with other models.)
- Tone generator lets you use an inductive pickup device, such as the Fluke Networks 140 A-Bug Tone Probe, to identify cables in a LAN installation.
- Optional link interface adapters let you test additional types of LAN cabling.

Standard Accessories

A DSP-4000 Series test tool comes with the following accessories, which are shown in Figure 1-1. If the test tool is damaged or something is missing, contact the place of purchase immediately.

- 1 DSP-4000SR, DSP-4100SR, or DSP-4300SR remote unit (not shown)
- The following link interface adapters:
 - ◇ With the DSP-4000 and DSP-4100: 2 DSP-LIA011 Basic Link Adapters for Cat 5E and 2 DSP-LIA012 Channel Adapters for Cat 6
 - ◇ With the DSP-4000PL: 2 DSP-LIA101 Permanent Link Adapters for Cat 6 and 2 DSP-LIA012 Channel Adapters for Cat 6
 - ◇ With the DSP-4300: 2 DSP-LIA101 Permanent Link Adapters for Cat 6, 1 DSP-LIA012 Channel Adapter for Cat 6, and 1 DSP-LIA013 Channel/Traffic Adapter for Cat 6
- 2 AC adapter/chargers 120 V (US only) or universal adapter/chargers and line cords (outside North America)
- 1 Memory card reader (DSP-4100, DSP-4300)
- 1 16 MB memory card (DSP-4100, DSP-4300)
- 1 Memory card carrying case (DSP-4100, DSP-4300; not shown)
- 2 NiMH battery packs (installed)
- 2 Headsets
- 1 DSP-4000 Calibration Module
- 1 RJ45 to BNC adapter
- 1 PC serial interface (EIA-232C) cable
- 2 Carrying straps
- 1 LinkWare™ CD
- 1 DSP-4000 Series Manual CD (includes complete users manual)
- 1 DSP-4000 Series Getting Started Guide
- 1 Warranty registration card (not shown)
- 1 Soft carrying case (not shown)

If you purchased optional Fiber Test Adapters, refer to the Fiber Test Adapter users manual for a list of fiber accessories.

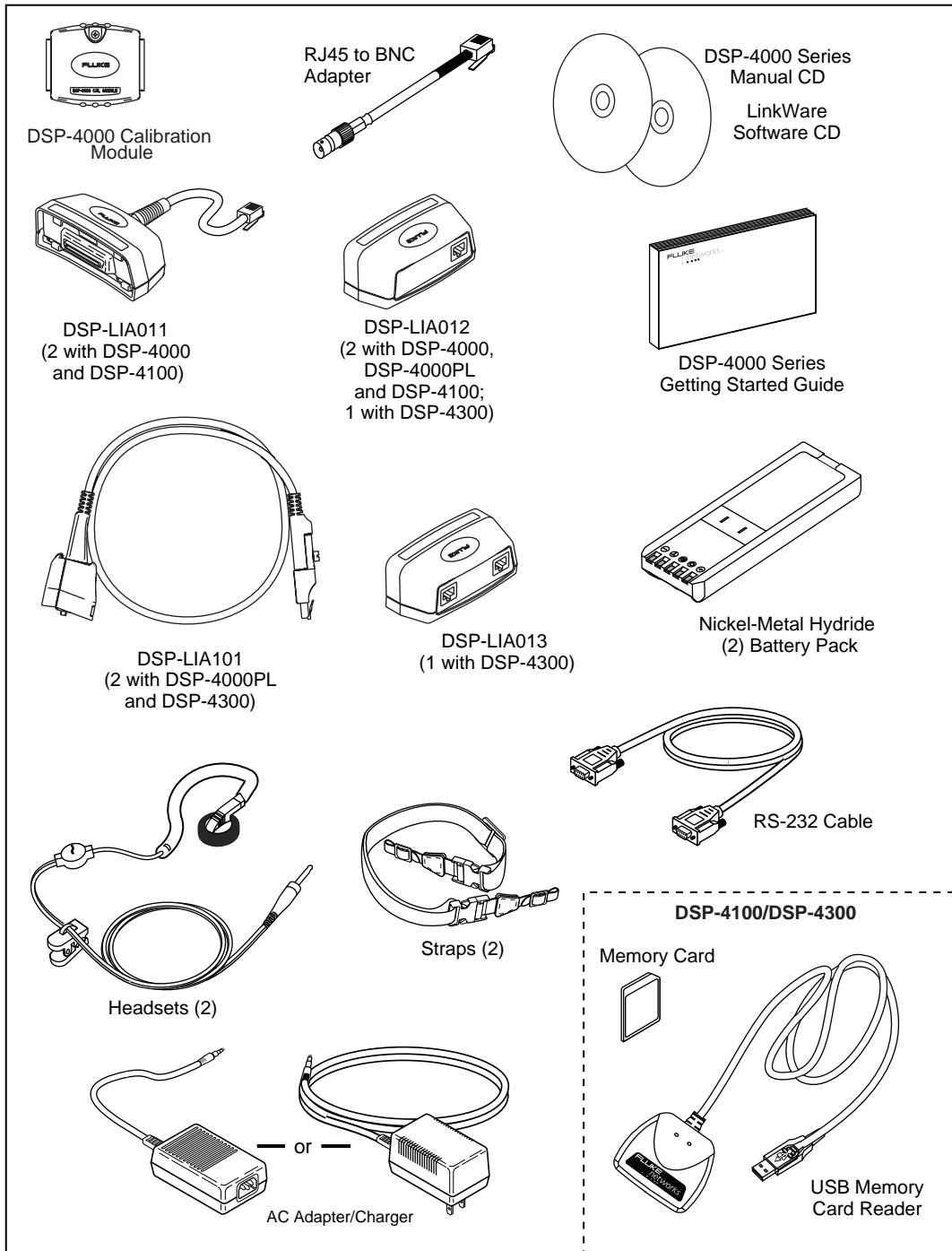

Figure 1-1. Standard Accessories

oy01f.eps

Using This Manual

Warning

Before using the test tool, carefully read "Safety and Operational Information" at the beginning of Chapter 2.

Except where noted, the information in this manual applies to all DSP-4000 Series test tools.

If you are familiar with the general features, functions, and operation of LAN cable testers and want to start testing cables immediately, proceed as follows:

1. Read "Quick Start" in Chapter 2 to prepare the test tool for operation, access the test tool's functions, and run an Autotest.
2. Refer to the test and setup features listed under "Rotary Switch" in Chapter 2 to locate functions in the test tool's menu structure.
3. Refer to the Glossary in the Appendix to find definitions for unfamiliar terms.

If you have never used a LAN cable tester, but want to start testing cables immediately and learn as you work, proceed as follows:

1. Read "Quick Start" in Chapter 2 to prepare the test tool for operation, access the test tool's functions, and run an Autotest.
2. Refer to the Glossary in the Appendix to find definitions for unfamiliar terms.
3. Refer to the test and setup features listed under "Rotary Switch" in Chapter 2 to locate functions in the test tool's menu structure.
4. Refer to Chapter 3, "Autotest," to find more detailed information about cable tests and test results.
5. Read Chapter 4, "Running Individual Tests," to learn how to run individual tests and monitor network traffic and impulse noise.
6. Read Chapter 7, "Basic Cable Testing," to add to your cable testing and troubleshooting knowledge.

If you have never used a LAN cable tester and want to learn about cable testing and troubleshooting before you use the test tool, proceed as follows:

1. Read Chapter 7, “Basic Cable Testing,” to learn the basics of LAN cable characteristics, testing, and interpreting test results.
2. Read Chapter 2, “Getting Started”, to learn about the test tool’s features and how to prepare the test tool for use.
3. Read Chapter 3, “Autotest,” to learn how to run the most commonly used cable test and interpret the test results.
4. Read Chapter 4, “Running Individual Tests,” to learn how to run individual tests and monitor impulse noise.
5. Refer to the test and setup features listed under “Rotary Switch” in Chapter 2 to locate functions in the test tool’s menu structure.
6. Refer to the Glossary in the Appendix to find definitions for unfamiliar terms.

For information on testing fiber cabling, refer to the users manual for your Fiber Test Adapter.

Chapter 2

Getting Started





Chapter 2 provides the following information:

- Safety and cautions to observe when using the test tool.
- Instructions for getting started quickly with the test tool.
- Detailed information on the test tool's features.
- Detailed instructions on configuring the test tool.

Read First: Safety and Operational Information

The international electrical symbols used on the instrument or in this manual are described in Table 2-1. Certification symbols are described in "Specifications" in Chapter 8.

Table 2-1. International Electrical Symbols

	Warning: Risk of electric shock.
	Warning or Caution: Risk of damage or destruction to equipment or software. See explanations in the manual.
	Equipment is protected by double insulation or reinforced insulation to protect the user against electric shock.
	Do not connect this terminal to public communications networks, such as telephone systems.

 **Warning**

To avoid possible fire, electric shock, personal injury, or damage to the test tool

- **If this product is used in a manner not specified by the manufacturer, the protection provided by the product may be impaired.**
- **Use only the ac adapter/charger provided with the test tool (PN 106200 or 944223) to charge the battery or power the test tool.**
- **Never connect the test tool to any telephony inputs, systems, or equipment, including ISDN. Doing so is a misapplication of this product, which can result in damage to the test tool and create a potential shock hazard to the user.**
- **Never connect the CABLE TEST input to any LAN inputs, systems, or equipment. Doing so is a misapplication of this product, which can result in damage to the test tool and create a potential shock hazard to the user.**
- **Always turn on the test tool before connecting it to a cable. Turning the test tool on activates the tool's input protection circuitry.**
- **When servicing the test tool, use only specified replacement parts.**
- **Do not use the test tool if it operates abnormally. Protection may be impaired.**
- **Do not use the test tool if it is damaged. Inspect the test tool before use.**

Caution

To avoid disrupting network operation and to ensure maximum accuracy of test results

- Except when monitoring network activity, never connect the test tool to an active network. Doing so may disrupt network operation.
- Never attempt to insert any connector other than an RJ45 connector into the RJ45 jack. Inserting other connectors, such as RJ11 (telephone) connectors, can permanently damage the jack.
- Never attempt to send data from a PC to the test tool while running a cable test. Doing so might cause erroneous test results.
- Never operate portable transmitting devices during a cable test. Doing so might cause erroneous test results.
- When using the channel/traffic link interface adapter (DSP-LIA013), never run tests with cables connected to both the cable jack and the monitor jack. Doing so might cause erroneous test results.
- To ensure maximum accuracy of test results, perform the self-calibration procedure as described in “Calibrating the Test Tool” in Chapter 6 every 30 days.
- To avoid false test results, recharge the battery as soon as the low battery message appears.
- If your test tool includes the DSP-LIA101 Permanent Link Adapters, see “Permanent Link Interface Adapters” later in this chapter for important handling information.

Quick Start

This section is for users who want to start using the test tool immediately with minimal instruction. For suggestions on additional reading that may be helpful to you, see “Using this Manual” in Chapter 1. To get started with the optional Fiber Test Adapters, refer to the Fiber Test Adapter users manual.

Note

New features may be available with software upgrades. Visit the Fluke Networks website at www.flukenetworks.com or contact your Fluke Networks representative for information on upgrades.

Powering the Test Tool

Before powering the test tool or remote with the NiMH battery pack, charge the battery for about 3 hours. To charge the battery, connect the ac adapter/charger to the test tool or remote and to ac line power. You can operate the unit on ac power while the battery charges. A fully-charged battery typically lasts at least 8 hours. See “Battery Status” later in this chapter for information on battery status messages.





Note

The ac adapter/charger will not power the test tool when the battery pack is removed.

Using the Menus

The test tool’s setup configuration, test selections, and test results are presented in a menu system. Table 2-2 shows the keys used to select items and move between screens in the menu system.

Table 2-2. Key Functions for the Menu System

Key	Function
	Allow up, down, left, and right movement on the display.
	Selects the highlighted item.
	Starts the highlighted test.
	Exits the current screen.
	Softkeys select the function displayed on the screen area above the key. Softkey functions depend on the screen displayed.

Using the Link Interface Adapters

The link interface adapters provide the correct connectors and interface circuitry for testing different types of LAN cable. The adapters also allow for upgrades when new types of cable are developed. See “Link Interface Adapter Features” in this chapter for more details.

If your test tool includes the DSP-LIA101 Permanent Link Adapters, see “Permanent Link Interface Adapters” in this chapter for important handling information.

Optional link interface adapters that provide additional functions are available from your Fluke Networks dealer. Visit the Fluke Networks website at **www.flukenetworks.com** for the most recent information on optional adapters.

Figure 2-1 shows how to attach a link interface adapter. Self-calibration is not required when you change adapters. The test tool displays a message if you try to run a test that is not supported by the attached link interface adapter. Refer to Appendix A for a list of tests supported by the standard link interface adapters.

The LIA Status selection on the SPECIAL FUNCTIONS menu reports the type of link interface adapter attached to the main and remote units. The status display also shows how many Autotests have been run with each adapter.

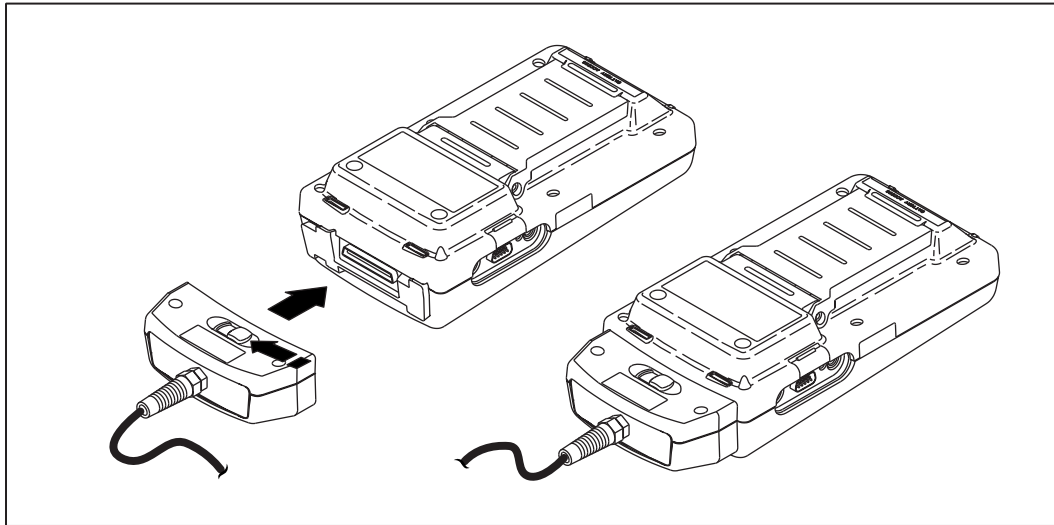

oy72f.eps

Figure 2-1. Attaching a Link Interface Adapter

Formatting the Memory Card (DSP-4100/4300)

Autotest results you save on a DSP-4100 or DSP-4300 test tool are stored on a removable memory card. One 16 MB card is included with the test tool. Compatible cards of different capacities can also be used in the test tool. Figure 2-2 shows how to insert and remove the card. You do not need to turn the test tool off before inserting or removing the card.

Before you store test results, the card must be formatted as follows:

1. Insert the card into the test tool as shown in Figure 2-2.
2. Turn the rotary switch to SPECIAL FUNCTIONS. Use \downarrow to select **Memory Card Configuration**; then press **ENTER**.
3. Press **4** **Format**; then press **3** **Yes** to begin formatting.

For instructions on using the memory card reader and transferring Autotest results to a PC, see the online help or “Getting Started” under Help on the LinkWare menu.

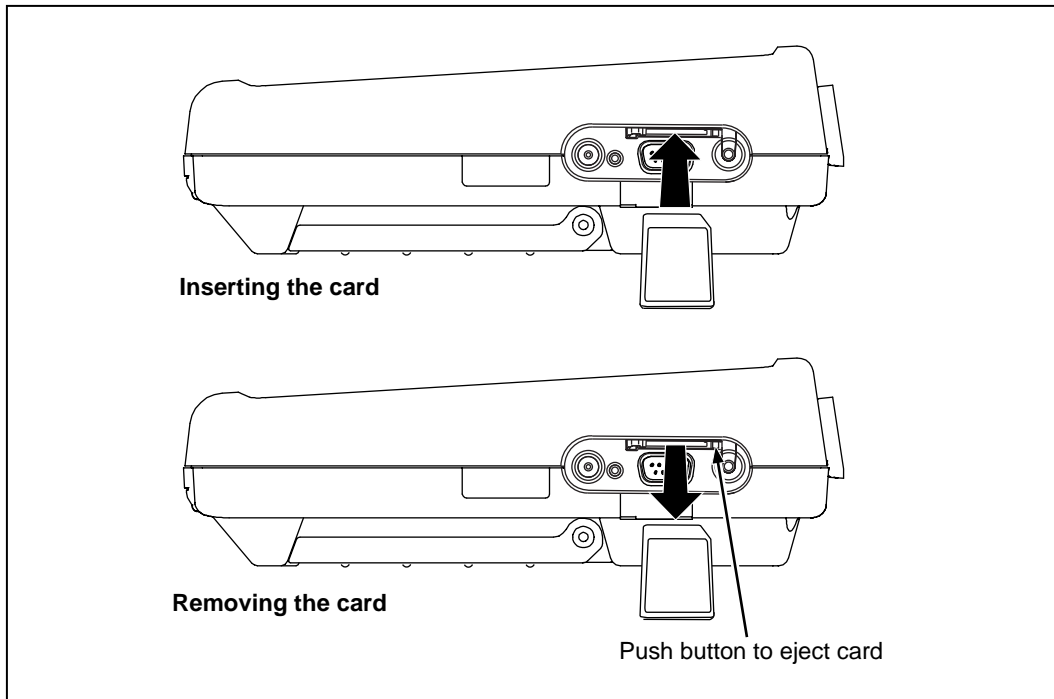

oy79f.eps

Figure 2-2. Inserting and Removing the Memory card

To see the status of the memory card, press the **Memory** softkey that appears on several of the Autotest displays or select **Memory Card Configuration** in the SPECIAL FUNCTIONS mode.

Caution

The test tool may not be able to read or store test results on a memory card that contains other types of data (such as music files).

Quick Configuration

The settings listed in Table 2-3 affect either the display format or the accuracy of your test results. Following the table are instructions for changing the settings. For a complete list of the test tool’s adjustable settings, refer to the later section “Setup.”

Table 2-3. Quick Configuration Settings

SETUP Setting	Description
Test Standard and Cable Type	Select the test standard and cable type you are using. Fiber optic cable testing requires a Fluke Networks DSP-FTA Fiber Test Adapter or a Fluke Networks DSP-FOM (Fiber Optic Meter; comes with the DSP-FTK).
Report Identification	Enter your company’s name, operators’ names, and site names. These names appear in the Autotest reports you save.
Auto Increment (cable ID setup)	Enabling this setting causes the last character of the cable ID to increment each time you save an Autotest. The Sequence selection lets you define a range of cable IDs by entering a start and end ID. On a DSP-4300, the Cable ID List selection lets you select a list of IDs that was created and saved on a memory card with LinkWare software.
Store Plot Data (DSP-4100/4300)	Enable this setting to store plot data (from tests such as attenuation, return loss, and NEXT) with Autotest results saved on a DSP-4100 or DSP-4300 test tool.
Length Units	Select meters or feet as the unit for length measurements.
Numeric Format	Select a format (0.00 or 0,00) for display of decimal fractions.
Display and Report Language	Select English, German, French, Spanish, Italian, Portuguese, or Japanese.
Power Line Noise Filter Frequency	Select the frequency of the ac power in your area. The test tool filters out 50 Hz or 60 Hz noise from measurements.

To change any of the settings shown in Table 2-3, proceed as follows:

1. Turn the rotary switch to SETUP.
2. If the setting you want to change is not on the first Setup screen, press **4** **Page Down** to see additional Setup screens.
3. Use **▼** **▲** to highlight the setting you want to change.
4. Press **1** **Choice**.
5. Use **▼** **▲** to highlight the setting you want.
6. Press **ENTER** to store the highlighted setting.
7. Repeat steps 2 through 6 to change additional settings.

Results within Accuracy Range

An asterisk following a test result value indicates that the value is within the test tool's range of accuracy, as shown in Figure 2-3. All tests except the wire map test may produce results with an asterisk if required by the selected test standard. If you want the asterisk to appear on the overall pass/fail test result as well as the individual test result, enable "Top Level Pass* Indication" in SETUP.

If a "pass" result is marked with an asterisk, look for ways to improve the cabling installation to eliminate the marginal performance. A "fail" result marked with an asterisk should be considered a failure.

The asterisk appears on displayed, uploaded, and printed test results.

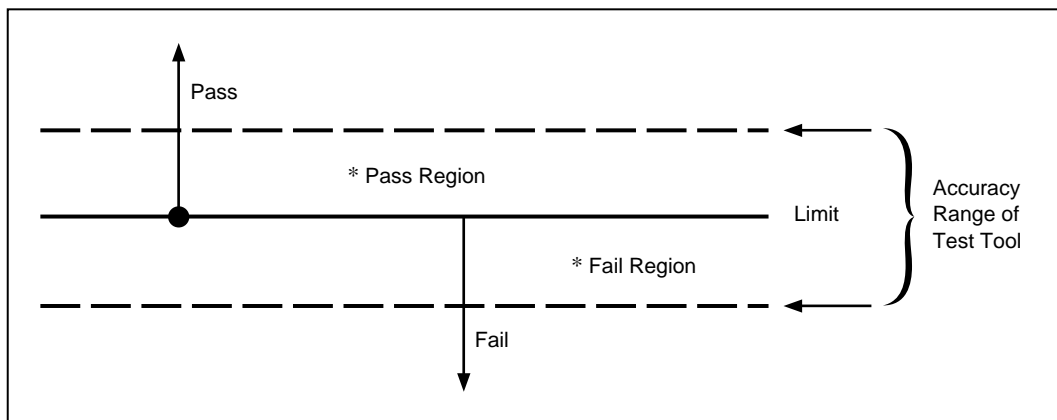

oy02f.eps

Figure 2-3. The Asterisk and Test Tool Accuracy

Autotest on Twisted Pair Cabling

Autotest performs all of the tests necessary to determine if the cabling you are testing meets the test standards specified for your LAN installation.

The following tests apply to twisted pair cabling:

- Headroom report (The worst-case margin for a parameter determined by the selected standard. This may be NEXT, ACR, PSNEXT, or another measurement.)
- Wire Map
- Resistance
- Length
- Propagation Delay
- Delay Skew
- Impedance
- NEXT and ELFEXT (Near-End and Equal Level Far-End Crosstalk)
- Attenuation
- ACR (Attenuation to Crosstalk Ratio)
- RL (Return Loss)
- PSNEXT (Power Sum NEXT)
- PSELFEXT (Power Sum Equal Level Far-End Crosstalk)
- PSACR (Power Sum ACR)

When you start an Autotest, the test tool displays a message if the attached link interface adapter does not support the selected test standard.

To Autotest twisted pair cabling, refer to Figures 2-4 through 2-6 and proceed as follows:

Note

If the calibration message appears after you start the Autotest, refer to “Calibrating the Test Tool” in Chapter 6 for complete calibration instructions.

1. Attach the appropriate link interface adapters to the main and remote units. Refer to the table in the Appendix.
2. Turn the remote's rotary switch to ON.
3. Connect the remote to the far end of the cable link. For channel testing, connect using the network equipment patch cord.
4. Turn the rotary switch on the main unit to AUTOTEST.
5. Verify that the settings displayed are correct. You can change these settings in the SETUP mode.
6. Connect the test tool to the near end of the cable link. For channel testing, connect using the network equipment patch cord.
7. Press **TEST** to start the Autotest.

Saving Test Reports

When an Autotest is complete, you can save the results by pressing **SAVE**. Use the alphanumeric display to enter a cable identification for the report; then press **SAVE** again. See Chapter 3 for details.

To create lists of cable IDs, see "Setting Up Cable IDs" in this chapter. You can view and delete saved Autotest reports in the SPECIAL FUNCTIONS mode.

See the online help or "Getting Started" under Help on the LinkWare menu for details on uploading reports to a PC.

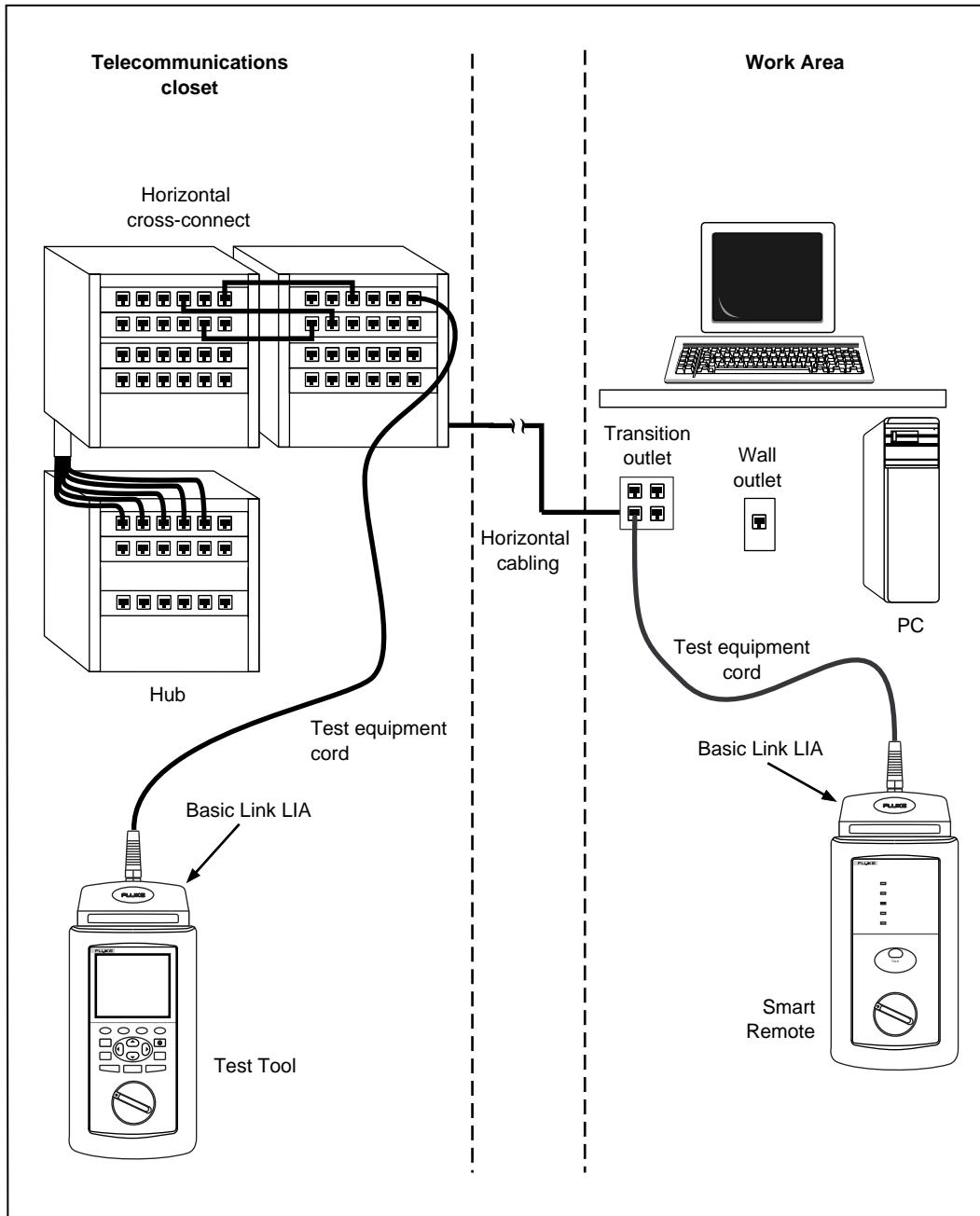

Figure 2-4. Typical Test Connections for a Basic Link

oy68f.eps

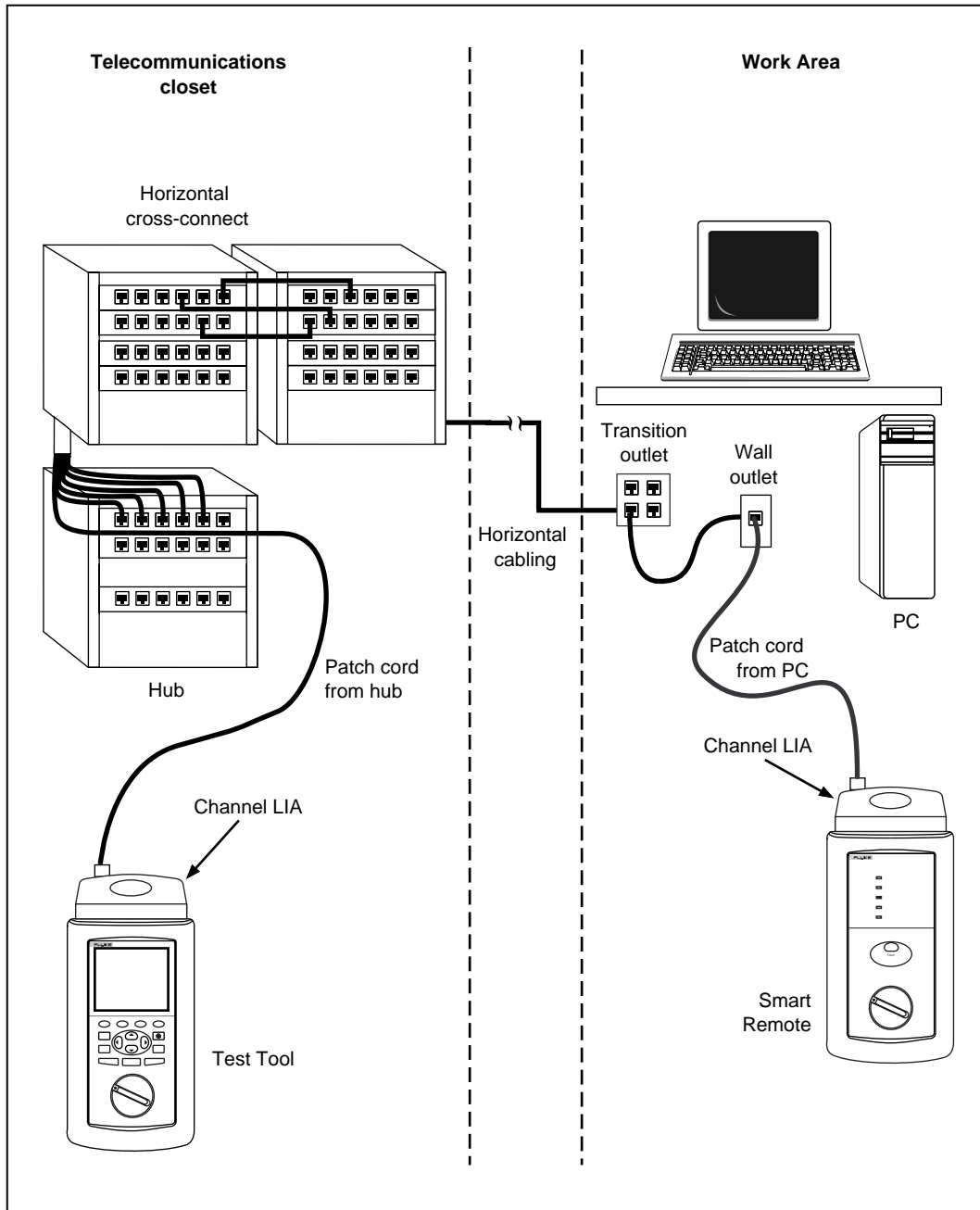

Figure 2-5. Typical Test Connections for a Channel

oy03f.eps

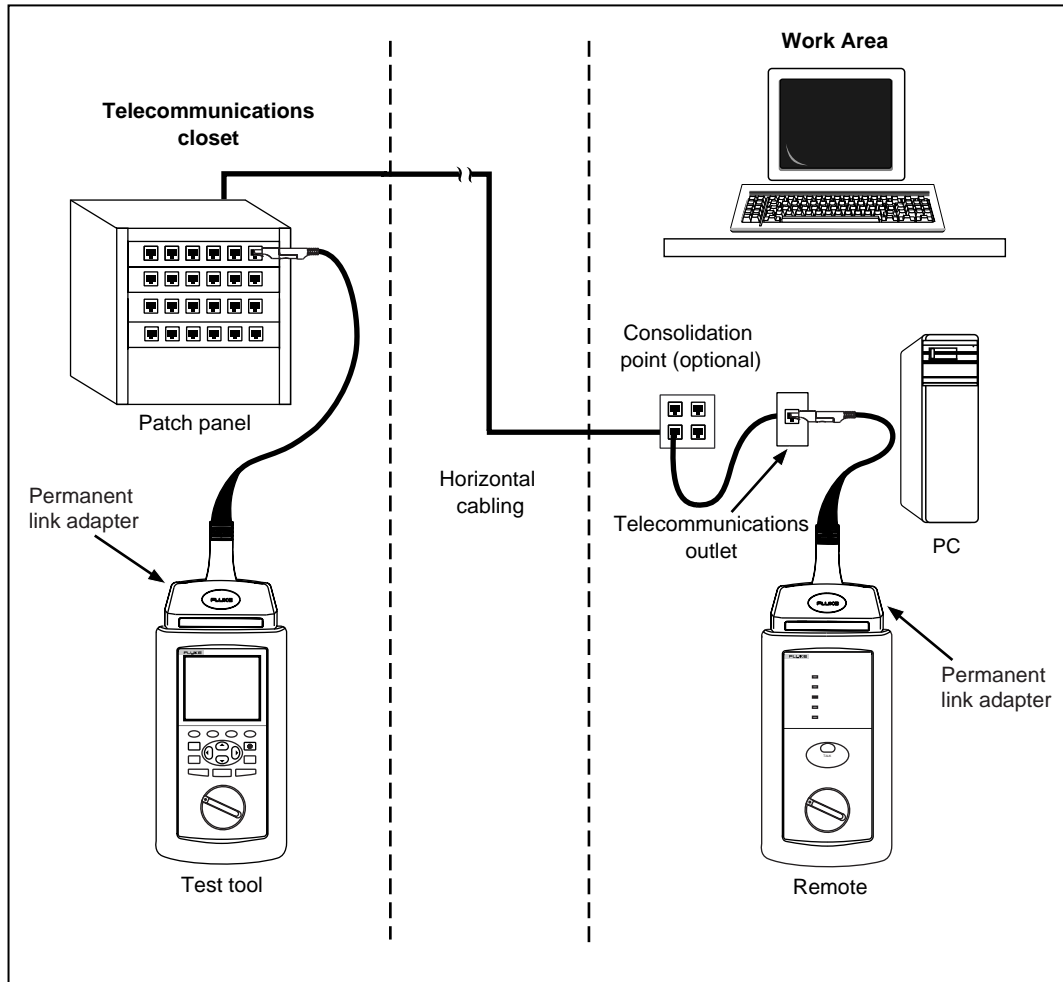

Figure 2-6. Typical Test Connections for a Permanent Link

oy84f.eps



Using the Talk Mode

The Talk mode allows two-way voice communication over twisted pair or fiber cable (Fiber Test Adapters are required for fiber cable). Two-way communication over twisted pair cable requires two good wire pairs.

Note

The Talk mode is disabled during cable tests. The DSP-LIA013 supports the Talk Mode only through the CABLE TEST jack.

Use the Talk mode as follows:

1. Connect the main and remote units to the cable under test.
2. Plug the headsets into the headset jacks on the main and remote units.
3. Press **TALK** on either the main or remote unit; then speak into the headset's microphone. To adjust the volume at the main unit, use  or . To adjust the volume at the remote, use **TALK** to cycle through the volume settings.
4. To exit the Talk mode, press **EXIT** or turn the rotary switch to a new position. The Talk mode turns off automatically when you start a cable test.

Autotest on Coaxial Cabling

The following tests are run during an Autotest on coaxial cabling:

- Impedance
- Resistance
- Length
- Anomaly detection (Results shown only if anomalies are detected.)

To run an Autotest on coaxial cabling, refer to Figure 2-7 and proceed as follows:

1. Turn off any PC nodes connected to the cabling you are testing.
2. If you want the Autotest to report cable length, remove the terminator from the far end of the cabling.
3. Attach any channel link interface adapter to the main unit.
4. Turn the rotary switch to AUTOTEST.
5. Verify that the test standard and cable type displayed are correct. You can change these settings in the SETUP mode.
6. Remove the terminator from the near end of the coaxial cabling. Use the RJ45 to BNC adapter to connect the cable to the test tool.
7. Press to start the Autotest.

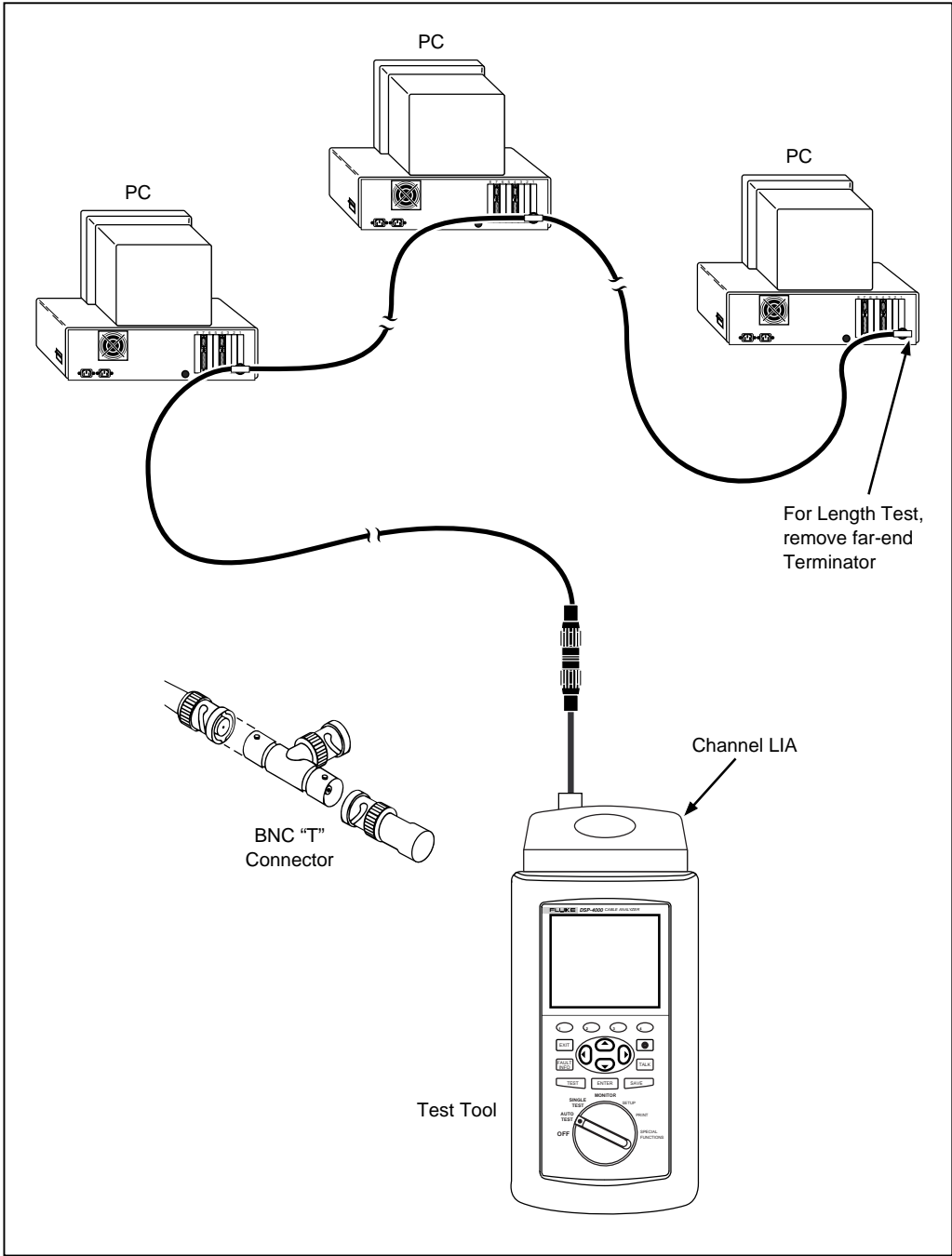

oy04f.epc

Figure 2-7. Autotest Connections for Coaxial Cabling

Main Unit Features

Figure 2-8 shows the features on the main unit and Table 2-4 explains their functions.

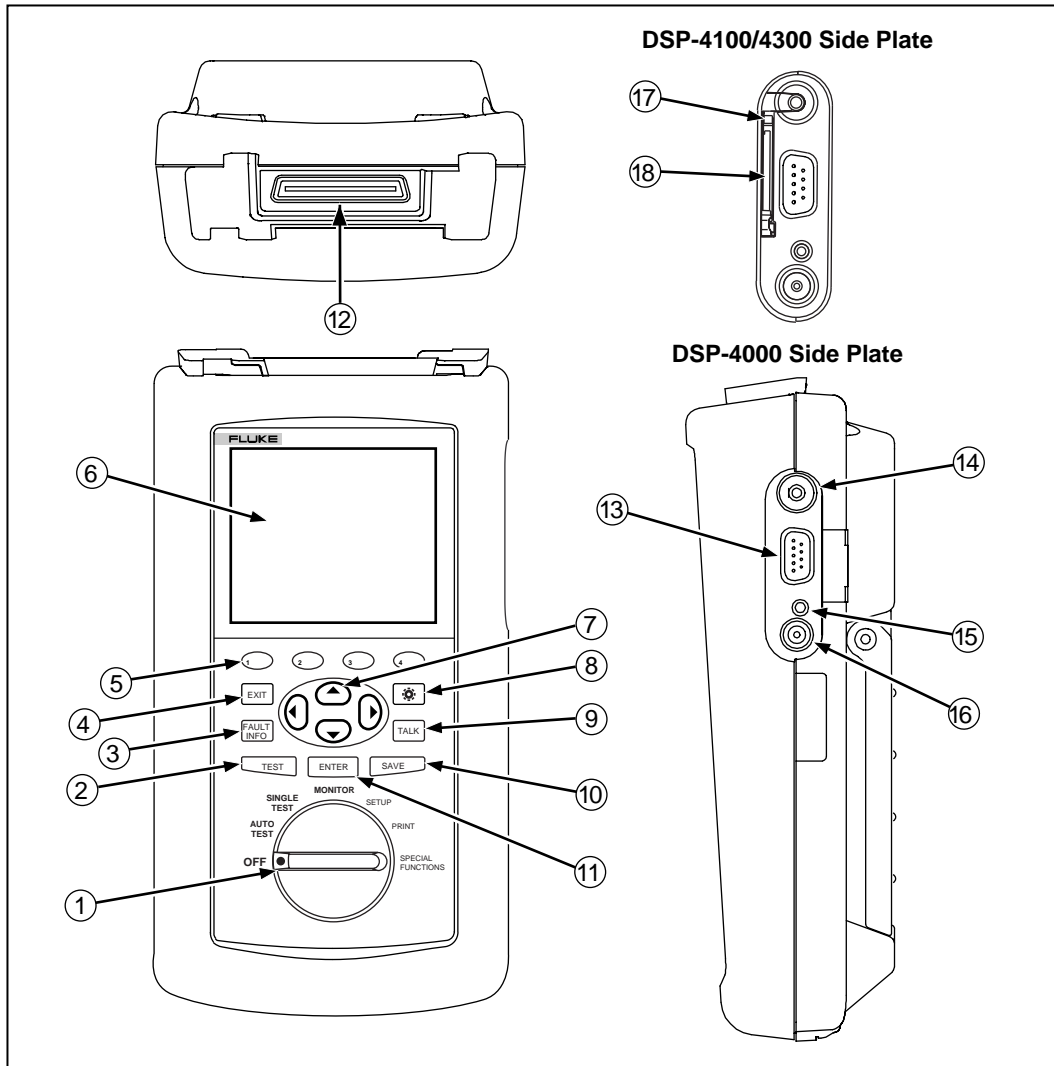

oy05f.eps

Figure 2-8. Main Unit Features

Table 2-4. Main Unit Features









Item	Feature	Description
①	Rotary Switch	Selects the test tool's modes.
②		Starts the highlighted test or restarts the test last run.
③		Automatically provides more specific information on the cause of an Autotest failure.
④		Exits the current screen without saving any changes you made.
⑤		Provide functions related to the concurrent display. Softkey functions are shown in the display area above the keys.
⑥	Display	A LCD display with backlight and adjustable contrast.
⑦		Allow left, right, up, and down movement on the display. Increase or decrease the numerical values of user-definable parameters.
⑧		Controls the display backlight. Pressing for 1 second allows adjustment of the display contrast. Reactivates the test tool when the tool is in power down mode.
⑨		Lets you use the headset for two-way voice communication over twisted pair or fiber cable.
⑩		Saves Autotest results and parameter changes in memory.
⑪		Selects the highlighted item from a menu.
⑫	LIA connector and latch	Connector and latch for the link interface adapters (LIAs).
⑬	RS-232C serial port	A 9-pin connector for interfacing with a printer or host computer via a standard IBM-AT EIA RS-232C serial cable.
⑭	2.5 mm phone jack	Connection for the headset supplied with the test tool.

Table 2-4. Main Unit Features (cont.)

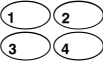
Item	Feature	Description	
⑮	AC power indicator	LED off, unit turned off	Battery is not charging. The charger is not plugged in.
		LED off, unit turned on	Battery is not charging. The charger is not plugged in or the test tool is running a test. When the test is finished, charging resumes unless the battery is already charged (>80%).
		LED flashing red	Fast charge pending. Charging is beginning. This state may last for several minutes until fast charging begins.
		LED steady red	Fast charge. The unit stays in fast charge mode for up to 4 hours, or until either the battery is fully charged or a test is initiated.
		LED steady green	Charge complete. Fast charge is complete. The unit enters trickle charge mode.
⑯	AC adapter/ charger jack	Connection for the ac adapter/charger supplied with the test tool.	
⑰	Eject button (DSP-4100/4300)	Button for ejecting the memory card.	
⑱	Memory card slot (DSP-4100/4300)	Slot for the memory card used for saving Autotest results on a DSP-4100 or DSP-4300 test tool.	

Remote Features

Figure 2-9 shows the features on the remote unit, and Table 2-5 explains their functions.

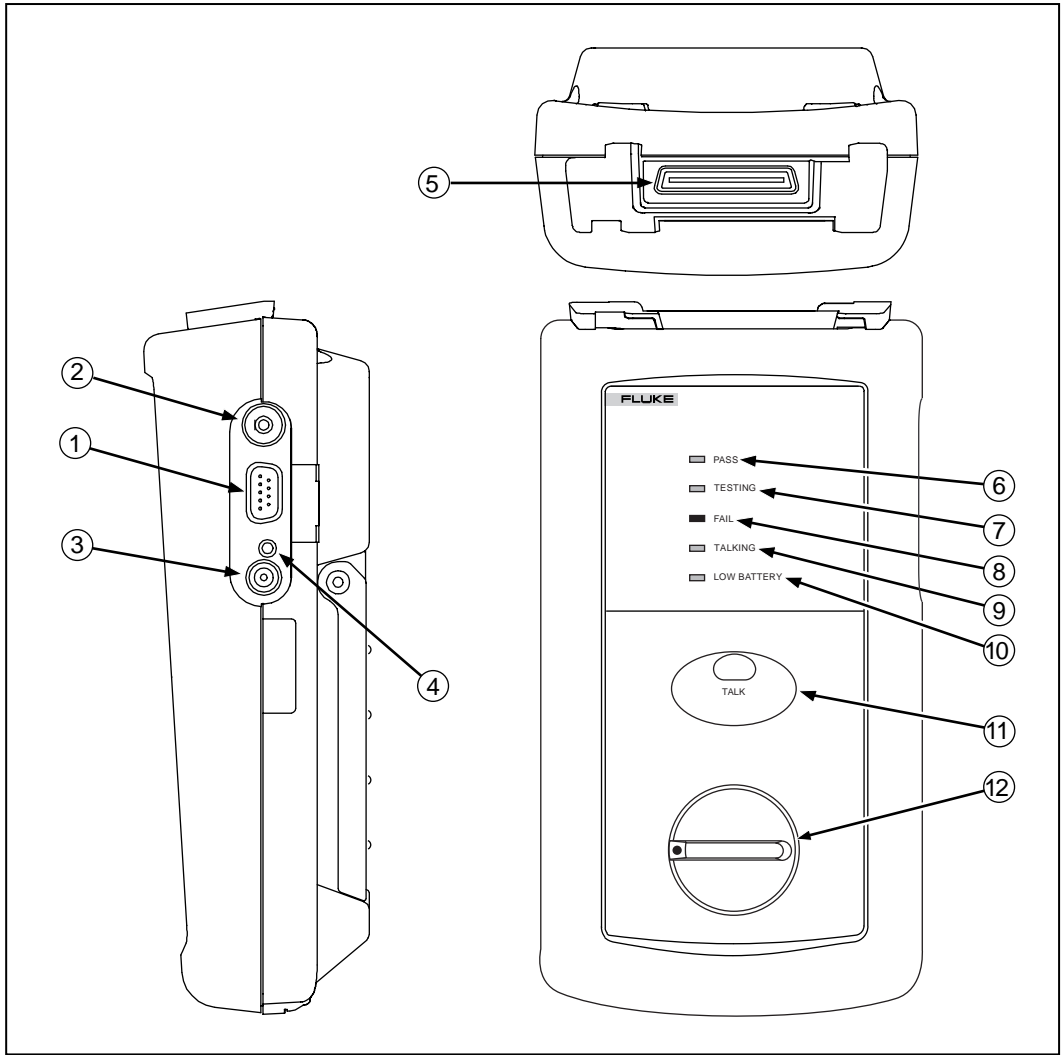

oy06f.eps

Figure 2-9. Remote Features

Table 2-5. Remote Connectors and Features

Item	Feature	Description	
①	RS-232C serial port	A DB9P connector for loading software updates.	
②	2.5 mm phone jack	Connection for the headset supplied with the test tool.	
③	AC adapter/ charger jack	Connection for the ac adapter/charger supplied with the test tool.	
④	AC power indicator	LED off, unit turned off	Battery is not charging. The charger is not plugged in.
		LED off, unit turned on	Battery is not charging. The charger is not plugged in or the test tool is running a test. When the test is finished, charging resumes unless the battery is already charged (>80%).
		LED flashing red	Fast charge pending. Charging is beginning. This state may last for several minutes until fast charging begins.
		LED steady red	Fast charge. The unit stays in fast charge mode for up to 4 hours, or until either the battery is fully charged or a test is initiated.
		LED steady green	Charge complete. Fast charge is complete. The unit enters trickle charge mode.
⑤	LIA connector and latch	Connector and latch for attaching link interface adapters.	
⑥	Pass LED	A green LED that turns on at the end of a test if no faults were detected.	
⑦	Test LED	A yellow LED that turns on when a test is in progress.	
⑧	Fail LED	A red LED that turns on at the end of a test if one or more faults were detected.	
⑨	Talking LED	A LED that turns on when the Talk mode is active.	
⑩	Low-battery LED	A LED that turns on when the remote battery voltage is low.	
⑪	 TALK	Lets you use the headset for two-way voice communication over twisted pair or fiber cable. When the Talk mode is active, this button controls the headset volume.	
⑫	Rotary switch	On/off switch for remote.	
The LEDs, items 6-10, also briefly indicates the battery charge level when you turn on the remote.			

Link Interface Adapter Features

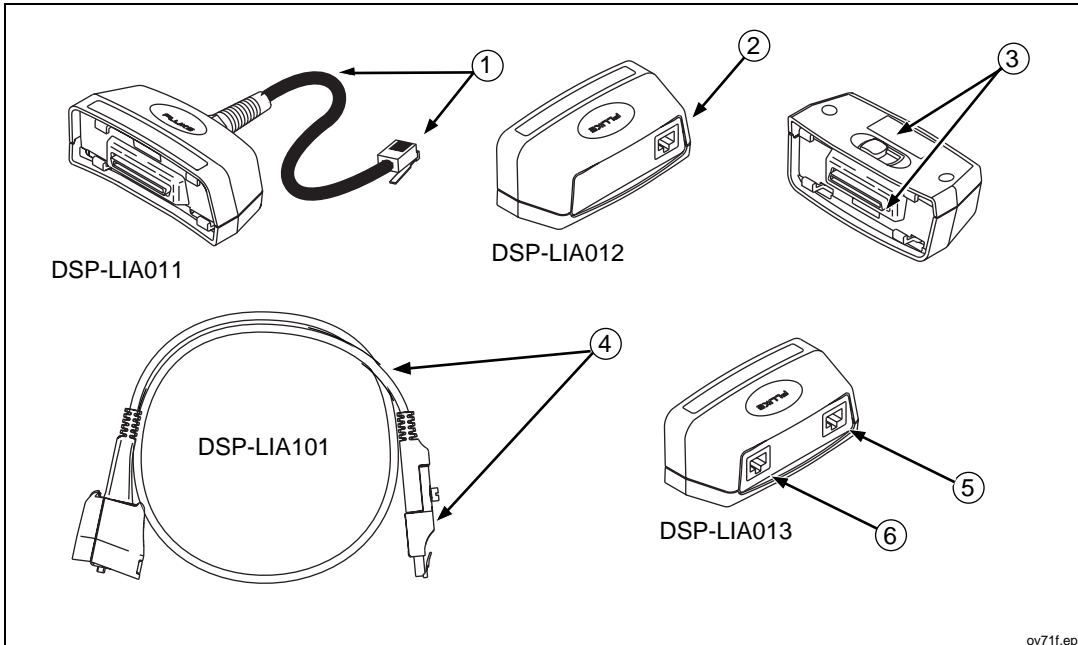

oy71f.ep

①	DSP-LIA011 cable and plug	Shielded Cat 5E twisted pair cable with a shielded Cat 5E RJ45 plug for testing basic link installations.
②	DSP-LIA012 jack	Shielded RJ45 jack for testing channel installations.
③	Latch and 60-pin connector	Latch and connector for attaching the LIA to a DSP-4000 Series test tool.
④	DSP-LIA101 cable with personality module (DSP-4000PL/ DSP-4300)	One meter of proprietary, high-performance cable terminated with a removable personality module. The personality module ensures electrical compatibility with a particular manufacturer's jack. See the next section for additional information. The standard module is designed for use with various jacks. Refer to the PMxx module list included for applications of available modules.
⑤	DSP-LIA013 CABLE jack	Shielded RJ45 jack for testing channel installations.
⑥	DSP-LIA013 MONITOR jack	Shielded RJ45 jack for traffic tests, the hub port capabilities test, and the hub port locator.

Figure 2-10. Link Interface Adapter Features

Permanent Link Interface Adapters (DSP-4000PL/4300)

Caution

To avoid damaging the adapter and to ensure maximum accuracy of test results, never pinch, kink, or crush the adapter's cable. Never use the cable as a handle to pick up the DSP test tool. Follow the handling guidelines given in Figure 2-11.

For the best accuracy, keep the adapter's cable as straight as possible during testing.

To avoid latent or immediate damage due to electrostatic discharge:

- Before handling a module or an adapter with no module attached, ground yourself when possible by touching a grounded, conductive surface.
- Always remove the adapter from the DSP test tool before changing the personality module.
- Always keep a personality module attached to the adapter cable.
- Always store the personality module in its original, static protection bag when not in use.

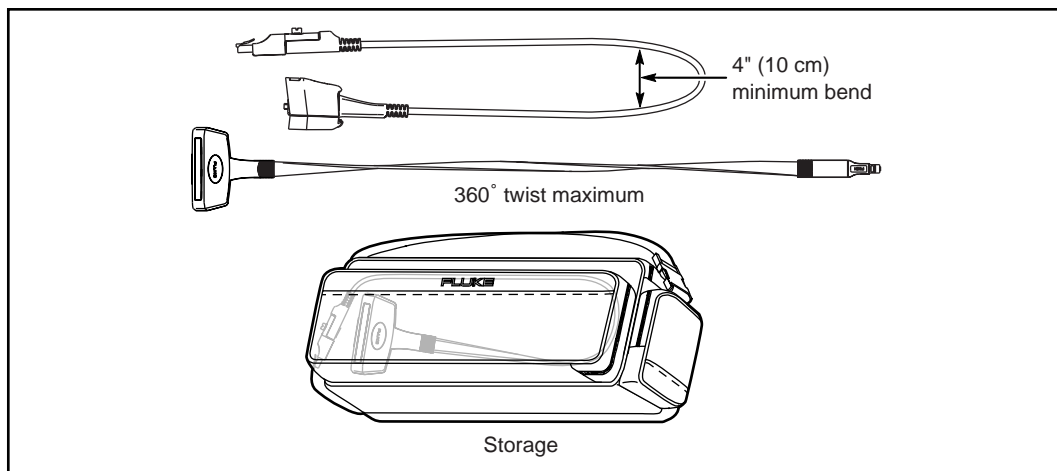

Figure 2-11. Permanent Link Adapter Handling Guidelines

oy85f.eps

Changing the Personality Module (DSP-4000PL/4300)

You can change the personality module to make the adapter compatible with a certain manufacturer's jack. Visit the Fluke Networks website for the most recent list of available personality modules.

Replace the module as follows (refer to Figure 2-12):

1. Ground yourself by touching a grounded, conductive surface.
2. Remove the link interface adapter from the DSP test tool.
3. Use your fingers to unscrew the screw on the personality module. If necessary, you can use a flat-blade screwdriver to loosen the screw.
4. Remove the module; then store it in its original, static protection bag.
5. Put the new module in place and tighten the screw with your fingers.

Caution

Tighten the screw snugly with your fingers only. Do not overtighten. Doing so can damage the module or the end of the cable.

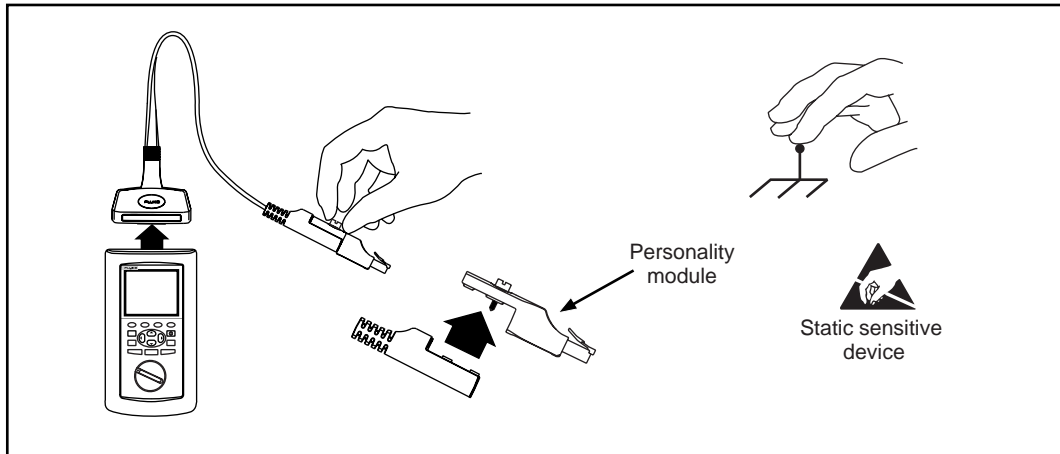

Figure 2-12. Changing the Personality Module

oy86f.eps

Strap and Bail

The test tool and the remote have a strap and a bail. Figure 2-13 shows how to attach the strap and open the bail.

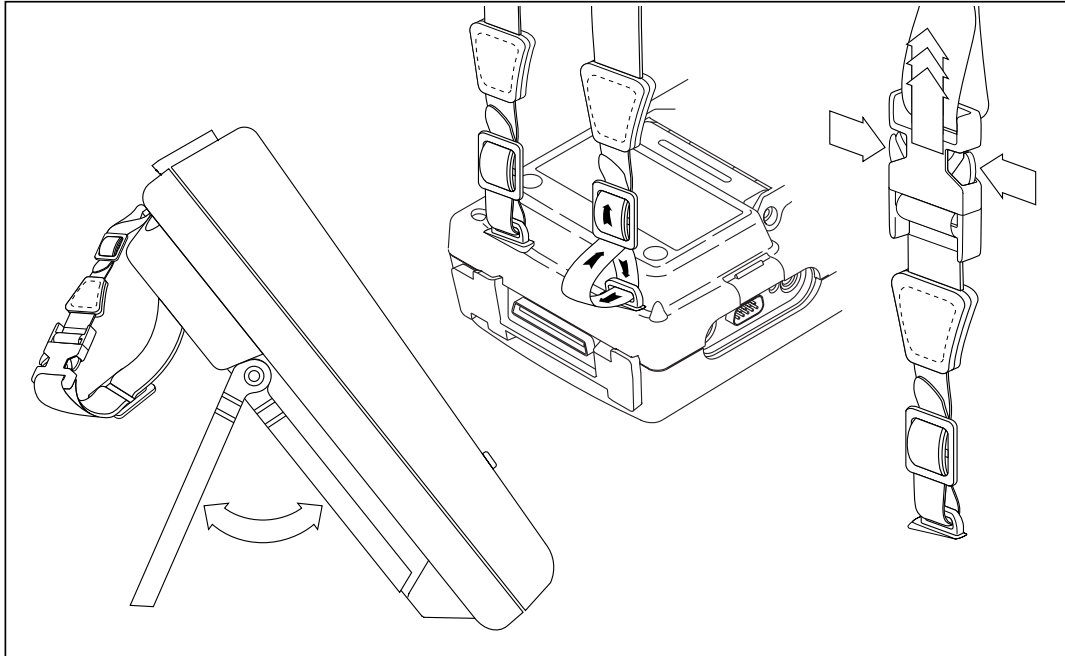

Figure 2-13. Attaching the Strap and Opening the Bail

oy07f.eps

Rotary Switch

The following paragraphs summarize the modes you can select with the rotary switch on the main unit.

Off

Turns the test tool off. Setup information and test results saved via the **SAVE** key are stored in nonvolatile memory.

Autotest

Autotest is the most frequently used function in LAN cable testing. Autotest performs all of the tests necessary to qualify the cabling you are testing. When the Autotest is complete, the tests that were run are listed with the overall result for each test. You can also view detailed results for each test. Results from Autotests can be saved for printing or transmission to a host computer.

The following tests apply to twisted pair cabling:

Note

The tests run during an Autotest on twisted pair cabling depend on the test standard selected. Tests not applicable to the selected test standard are not run or displayed. For a list of the tests and limits associated with common standards, see the document provided on the Fluke Networks website at www.flukenetworks.com.

- **Headroom:** Reports the worst-case margin for a parameter determined by selected test standard. This may be NEXT, ACR, PSNEXT, or another measurement.
- **Wire Map:** Tests for opens, shorts, crossed pairs, reversed wires, and split pairs.
- **NEXT and ELFEXT:** Tests twisted pair cabling for near-end crosstalk (NEXT) and equal level far-end crosstalk (ELFEXT).
- **Length:** Displays the length of twisted pairs in feet or meters.
- **Propagation Delay:** Measures the times taken for a signal to travel the length of each cable pair.
- **Delay Skew:** Calculates the differences in propagation delays between the cable pairs.
- **Impedance:** Measures the impedance of each cable pair. If impedance anomalies are detected, the test reports the largest anomaly detected on each cable pair.

- Attenuation: Measures the attenuation of each cable pair.
- DC Resistance: Measures the loop resistance of each cable pair.
- ACR: Calculates the ratio of attenuation to crosstalk for all combinations of cable pairs.
- RL (Return Loss): Measures signal loss due to signal reflections in the cabling.
- PSNEXT (Power Sum NEXT): For each cable pair, PSNEXT is calculated as the sum of the NEXT from all other pairs.
- PSELFEXT (Power Sum ELFEXT): For each cable pair, PSELFEXT is calculated using the sum of the FEXT from the other pairs.
- PSACR (Power Sum ACR): For each cable pair, PSACR is calculated using the sum of the NEXT from the other pairs.

The following tests apply to coaxial cabling:

- Impedance: Measures the impedance of the cable.
- Resistance: Measures the loop resistance of the cabling, shield, and terminator.
- Length: Measures the length of unterminated cables.
- Anomaly Detection: During a coaxial cable test, the test tool also detects and reports the position of the largest impedance anomaly (if any are present) on the cable.

Single Test

The SINGLE TEST mode provides access to the individual tests defined by the selected test standard, except for the ACR test. This mode also lets you run the HDTDR™ and HDTDX™ analyzer tests. A scanning function, which continuously repeats the test, is available for the wire map, resistance, HDTDR, and HDTDX analyzer tests. Single tests are useful for isolating cabling faults and quickly checking repairs.

Monitor

The MONITOR mode lets you continuously monitor impulse noise on twisted pair network cabling. With the DSP-LIA013 link interface adapter, you can monitor network activity on Ethernet systems. Network activity is monitored for collisions, jabber, and percentage of system utilization. The traffic adapter also includes a hub port locator, which helps you determine port connections at a hub, and a hub port capabilities feature that determines the standards supported by a port.

Setup

Allows you to do the following:

- Select a test standard and cable type.
- Edit the report identification that appears on saved Autotests.
- Set up the tester to automatically generate cable IDs.
- On DSP-4100 and DSP-4300 test tools, you can set the test tool to save attenuation, return loss, NEXT, and FEXT plots as part of Autotest reports when those tests are required by the selected test standard.
- Set the backlight timer to turn off the backlight after a specified period of inactivity.
- Set the power-down timer to switch the test tool to a low-power mode after a specified period of inactivity.
- Select interface parameters for the serial port.
- Set the date and time.
- Select a format for the date and time.
- Select a unit for length measurements.
- Select a format for displaying decimal fractions.
- Select a language for the display and printed reports.

- Select a frequency for the power line noise filter.
- Set the fault threshold for the impulse noise test.
- Enable or disable the test tool's beeper.
- Modify test standards for custom test configurations.
- Select a remote end configuration when a Fiber Test Adapter is attached.

Print

Allows you to send saved reports or report summaries to a serial printer. You can print the results from previously stored Autotests. Also lets you edit the report identification information and select a format for Autotest reports sent directly to a printer.

Special Functions

Allows you to do the following:

- View or delete test reports saved in memory.
- Change the cable identification assigned to a saved Autotest report.
- Generate a tone to use with an inductive pickup device, such as the Fluke Networks 140 A-Bug Tone Probe, to identify cabling runs.
- Determine the cable NVP to ensure maximum accuracy of length results.
- View the status of the NiMH battery in the main unit or remote.
- Check the status of the LIA attached to the main or remote unit.
- Perform a self-calibration on the test tool and remote.
- Run a self-test to verify proper operation of the test tool, link interface adapter, and remote.
- On DSP-4100 and DSP-4300 test tools, you can view the status of the memory card and format the card.
- View version information for the main and remote units.

Turning On the Test Tool

To turn on the test tool, turn the rotary switch from OFF to any one of the available modes. The power-up screen, which appears for about 3 seconds, shows the software, hardware, and test standards versions for the main and remote units. (The remote information is shown only if the remote is on and connected to the main unit.) For a longer look at the power-up screen, hold down any key while turning the test tool on. Or, select **Version Information** in the SPECIAL FUNCTIONS mode.

During this time, the test tool also performs a self-test. If a fault is detected during the self-test, the following message appears: **INTERNAL FAULT DETECTED. REFER TO MANUAL**. For information, see “If the Test Tool Fails” in Chapter 8.

Selecting a Language for Displays and Reports





The test tool displays results and prints reports in English, German, French, Spanish, Italian, Japanese, and Portuguese.

The test tool displays a language selection screen if a language has not been selected since the tool left the factory. Afterwards, you can change the language as follows:

1. Turn the rotary switch to SETUP.
2. Press **4** **Page Down** to find the language selection.
3. Use **▼** to highlight the currently selected language.
4. Press **1** **Choice**.
5. Use **▼** **▲** to highlight the language you want.
6. Press **ENTER** to accept the highlighted language. The test tool's display now appears in the selected language.

Performing a Self-Test

The self-test verifies that the test tool, link interface adapters, and remote are operating properly. To run the self-test, proceed as follows:

1. Turn the rotary switch to SPECIAL FUNCTIONS. Turn the remote on.
2. Use  to highlight **Self Test**.
3. Press .
4. Use the DSP-4000 Calibration Module to connect the test tool to the remote.
5. Press  to start the self-test.
6. When the self-test is complete, you can either return to the main Special Functions menu by pressing  or start a new operation by turning the rotary switch to a new position.

If the self-test fails, refer to “If the Test Tool Fails” in Chapter 8.

Overvoltage Test

The test tool periodically checks for dc voltages on twisted pair cabling under test. A dc voltage means that the test tool is connected to an active telephone cable or other power source. If voltage is detected, the following message appears:

**WARNING! EXCESSIVE VOLTAGE DETECTED AT INPUT.
UNPLUG CABLE NOW!** . The remote unit beeps and all LEDs flash continuously. Voltage on the cabling can damage the test tool or cause errors in measurements. Voltage must be removed before you can run any tests.

Always turn on the test tool before connecting it to a cable. Turning the test tool on activates the tool’s input protection circuitry.

Noise Test

The test tool periodically checks for excessive electrical noise on the cabling under test. Noise sources include nearby electrical equipment and transmitters and live network transmissions on adjacent cables. If excessive noise is detected, the test tool displays **Noise Detected** and automatically attempts to filter the noise to meet published accuracy specifications. If the test tool cannot filter out all the noise, and you save the test results, the test report will include the message “WARNING Excessive noise detected. Measurement accuracy may be degraded”.

To stop the test and return to the first screen of the selected test mode, press **EXIT**.

Configuring the Test Tool

The following sections provide more details about configuring your test tool. You can configure the test tool in the SETUP mode, or you can use the LinkWare software provided to download SETUP selections from a PC to your test tool.

Controlling the Backlight





To toggle the backlight between its two levels of brightness, press **☀** on the keypad. You can set the backlight timer to automatically turn off the backlight after a specified period of inactivity. You can also disable the backlight timer.

To set the backlight timer or disable the timer, proceed as follows:

1. Turn the rotary switch to SETUP.
2. Press **4** **Page Down**.
3. Use **▼** to highlight the backlight time-out setting.
4. Press **1** **Choice**.
5. Use **▼** **▲** to highlight the desired time-out period or the disable status.
6. Press **ENTER** to accept the highlighted selection.

When the backlight time-out is enabled, the backlight timer starts counting down after all tests are complete or after the last key entry or movement of the rotary switch. To restart the backlight timer while the backlight is on, press any key (except the backlight key) or turn the rotary switch to a new mode.







Adjusting the Display Contrast

To adjust the display contrast, hold down  for 1 second or longer. The following message appears: **USE   KEYS TO ADJUST CONTRAST.** Adjust the contrast to the desired level then press  to accept the new level. The display contrast setting is saved in memory when you turn off the test tool.

Selecting a Power Line Filter Frequency

The test tool has a noise filter to keep ac noise (50 Hz or 60 Hz) from affecting resistance measurements.

To set the frequency of the noise filter to the frequency of your ac power, proceed as follows:

1. Turn the rotary switch to SETUP.
2. Press  **Page Down** until you see the power line frequency setting.
3. Use  to highlight the power line frequency.
4. Press  **Choice**.
5. Use   to highlight the frequency you want.
6. Press  to accept the highlighted frequency.

Selecting a Test Standard and Cable Type

The test standard and cable type you select determine which standards are used and which tests are run during cable testing. The test tool is equipped with information for all the common test standards and cable types.

Several of the test standards for twisted pair cable are defined for both a channel and a permanent link configuration. The test limits for a channel are looser than those for a permanent link because the channel limits allow for the effects of two connections at a horizontal cross-connect and a transition connector near the telecommunications outlet in the work area. Figures 2-5 and 2-6 earlier in this chapter show the connections involved in a permanent link and a channel. Chapter 7 further explains these connections.

Note

The test tool displays a message if you try to run a test not supported by the attached link interface adapter.

To select a test standard and cable type, proceed as follows:

1. Turn the rotary switch to SETUP.
2. Press **1** **Choice**. The standards list starts with the last five standards used. Press **4** **Page Down** to see more standards.
3. Use **▼** **▲** to highlight the test standard you want.
4. Press **ENTER** to accept the highlighted test standard. The test tool displays a menu of the cable types valid for the selected test standard.
5. Use **▼** **▲** to select the cable type you want; then press **ENTER**.
6. If you selected a shielded cable type, the next display lets you enable or disable the shield test. Use **▼** **▲** to select the setting you want; then press **ENTER**.

You can test cables for NEXT, ELFEXT, PSNEXT, ELFEXT, attenuation, and ACR, and PSACR up to 350 MHz. Test limits apply only up to the frequency specified by the selected test standard.

Editing the Report Identification

The report identification includes a custom header (your company name, for example), an operator name, and a site name. These items appear on saved Autotest reports. You can view and edit this information as follows:

1. Turn the rotary switch to SETUP.
2. Use \blacktriangledown to highlight **Edit** under **Report Identification**; then press $\boxed{\text{ENTER}}$. The REPORT IDENTIFICATION display shows the information that will appear on the Autotest reports you save.
3. Use \blacktriangledown \blacktriangleup to highlight the information you want to edit; then press $\boxed{\text{ENTER}}$.

If you are editing an operator or site name, you can press $\textcircled{2}$ **New** to add a new name. The **New** softkey appears only if less than 20 names have been entered. If 20 names have been entered, you must delete a name before adding a new name.

To rename or delete an existing operator or site name, press $\textcircled{1}$ **Edit**, select the desired name; then press $\textcircled{1}$ **Rename** or $\textcircled{2}$ **Delete**. Changes to names preceded by a "\$" appear on printed test reports. You cannot delete a name that is used on a saved report.

4. To add characters to the name, use the \blacktriangleleft \blacktriangleright and \blacktriangledown \blacktriangleup keys to highlight characters in the list, then press $\boxed{\text{ENTER}}$.

To delete the character left of the cursor, press $\textcircled{4}$ **Delete**.

To edit characters in the middle of a name, use $\textcircled{1}$ \blacktriangleleft to move the cursor into the name.

To move the cursor back to the right-most character, press $\textcircled{1}$ \blacktriangleleft until the cursor wraps back to the right.

To increment or decrement an alphanumeric character anywhere in the cable identification, use $\textcircled{1}$ \blacktriangleleft to highlight the desired character; then press $\textcircled{2}$ **INC** or $\textcircled{3}$ **DEC**.

5. To store the name, press $\boxed{\text{SAVE}}$.

Note

You can use LinkWare software to download report identification information from a PC to the test tool.

Setting Up Cable IDs

The cable identification (cable ID) is the name you assign to the Autotest results you save. You can create a cable ID each time you save an Autotest, or you can use IDs generated as follows:

- The auto increment function generates IDs by incrementing the last alphanumeric character in the cable ID.
- The auto sequence function generates IDs by incrementing characters through a range of values defined by a start and end ID.
- On a DSP-4300 test tool, you can select IDs from lists downloaded to a memory card. You can create and download the lists with LinkWare software. See the online help or “Getting Started” under Help on the LinkWare menu for details.

Enabling the Auto Increment Function

The test tool’s auto increment function increments only the last alphanumeric (letter or number) character of the cable identification name each time you save Autotest results.

To enable or disable the auto increment function, proceed as follows:

1. Turn the rotary switch to **SETUP**.
2. Use **4** **Page Down** and **▼ ▲** (if necessary) to highlight the auto increment setting; then press **1** **Choice**.
3. Use **▼ ▲** to highlight **Enable**; then press **ENTER**.

The last character of the cable ID you enter when you save the next Autotest will be incremented when you save subsequent Autotests.

Determining a Range of Cable IDs for the Auto Sequence Function

Use the following guidelines when determining a range of cable IDs to use with the auto sequence function.

- Cable IDs can contain a maximum of 18 letters, numbers, and special characters (such as -, #, and spaces). Accented characters are not available.
- The types of characters used in each position must match between the range's start and end ID. For example, using the letter "O" as the third character in the start ID and the number "0" as the third character in the end ID generates an error message.
- The auto sequence function increments letters and numbers starting with the farthest right character, then moving left. Special characters and matching characters are not incremented. As an example, the following range of cable IDs could be assigned for testing the cabling in 2 rooms where each room has 3 cable drops:

Start ID: ROOM A DROP#1

End ID: ROOM B DROP#3

The test tool would name the Autotest results in the following sequence:

ROOM A DROP#1

ROOM A DROP#2

ROOM A DROP#3



















ROOM B DROP#1

ROOM B DROP#2

ROOM B DROP#3

If you try to save Autotest results after the last ID was used, the list shown after you press **SAVE** shows that all IDs are used by saved reports (used IDs are preceded by a "\$"). Use the **Edit** or **New** softkeys to create a new ID. See Chapter 3 for more information.

Enabling and Configuring the Auto Sequence Function









1. Determine the range of cable names you want to use for your Autotests. (Refer to the previous section.)
2. Turn the rotary switch to SETUP.
3. Use  to highlight the auto increment setting; then press  **Choice**.
4. Use   to highlight **Sequence**; then press  **Edit ID Seq.**
5. Use  to select the **Start ID** or **End ID** field for editing.
6. To add characters to the ID, use the     keys to highlight a character in the list, then press .
Use   and   to move the cursor through the ID.
Use  **Delete** to delete characters to the left of the cursor.
7. Press  when you are finished; then press .

When necessary, you can edit the cable ID when you save an Autotest. See Chapter 3 for information on saving Autotest results with the auto sequence function enabled.

Selecting a List of Downloaded IDs (DSP-4300)

On a DSP-4300 test tool you can select cable IDs from lists created with LinkWare software and saved on a memory card. See the online help or “Getting Started” under Help on the LinkWare menu for details.

To select a downloaded list as the source for cable IDs, proceed as follows:

1. Put a memory card that holds one or more cable IDs lists into the test tool.
2. Turn the rotary switch to SETUP.
3. Use   to highlight the auto increment setting; then press  **Choice**.
4. Use   to highlight **Cable ID List**. To view the lists available on the memory card, press  **Select ID List**.
5. Use   to highlight the list you want to use; then press . The selected list appears when you save an Autotest.

Viewing the Cable ID Configuration and Memory Status

To see the cable ID configuration (if one is enabled), the number of Autotests saved in memory, and the available memory, press the **Memory** softkey that appears on several of the Autotest displays.

On a DSP-4100 or DSP-4300 you can see the memory card status by selecting **Memory Card Configuration** in the SPECIAL FUNCTIONS mode. Model DSP-4300 shows the status of the internal memory if no memory card is present.

Storing Plot Data with Saved Autotest Results (DSP-4100/4300)

When STORE PLOT DATA is enabled, saved Autotest results include plot data from tests such as the attenuation and NEXT tests. HDTDX and HDTDR plots are also saved with the Autotest results. Saving the plot data lets you include plots on test reports uploaded to a PC and printed with LinkWare Software. The DSP-4100 and DSP-4300 can save the results of at least 250 Autotests on a 16 MB memory card when plot data is included. More results can be saved if plot data is not included.

The DSP-4300 can save at least 250 Autotest results with plot data in internal memory when a memory card is absent.

Enable or disable this setting as follows:

1. Turn the rotary switch to SETUP.
2. Use **4** **Page Down** and **▼** to find and highlight the store plot data setting.
3. Press **1** **Choice**.
4. Use **▼** **▲** to highlight the desired setting; then press **ENTER**.

Selecting a Length Unit

The test tool displays length measurements in meters or feet.

To change the unit of measurement, proceed as follows:

1. Turn the rotary switch to SETUP.
2. Press **4** **Page Down** until you see the length units setting.
3. Press **1** **Choice**.
4. Use **▼** **▲** to highlight the desired unit.
5. Press **ENTER** to accept the highlighted unit.

Selecting a Numeric Format

The test tool displays decimal fractions with a decimal point separator (0.00) or a comma separator (0,00).

To change the numeric format, proceed as follows:

1. Turn the rotary switch to **SETUP**.
2. Press **4** **Page Down** until you see the numeric format setting.
3. Use **▼** to highlight the numeric format.
4. Press **1** **Choice**.
5. Use **▼** **▲** to highlight the desired format.
6. Press **ENTER** to accept the highlighted format.

Setting the Date and Time

The test tool has a clock that records the date and time for saved test results.

To change the date or time or the format for the date or time, proceed as follows:

1. Turn the rotary switch to **SETUP**.
2. Press **4** **Page Down** until you see the date and time settings.
3. Use **▼** to highlight the date or time parameter you want to change.
4. Press **1** **Choice**. The display you see next depends on which parameter you are changing.



If you are changing the date or time, use **4** **INC** or **3** **DEC** to increment or decrement the highlighted number. Use **◀** **▶** to move the highlighted area from one number to another number.

If you are changing the date or time format, use **▼** **▲** to highlight the format you want.







5. Press **ENTER** to accept the highlighted date, time, or format.

Setting the Power-Down Timer

To extend battery life, you can set the power-down timer to automatically switch the test tool to a low-power mode after a selected period of inactivity. You can also disable the power-down timer.







When the test tool switches to low-power mode, the display goes blank. To reactivate the display, press . The test tool turns itself off if not used for 30 minutes after power-down. When this happens, pressing  turns on the test tool as though it were turned on with the rotary switch.

To set the power-down timer or enable/disable the timer, proceed as follows:

1. Turn the rotary switch to SETUP.
2. Press  **Page Down**.
3. Use  to highlight the power-down timer status.
4. Press  **Choice**.
5. Use   to highlight the desired time-out period or the enable/disable status.
6. Press  to accept your selection.

Enabling or Disabling the Audible Tones

To enable or disable the test tool's audible tones, proceed as follows:

1. Turn the rotary switch to SETUP.
2. Press  **Page Down** until you see the audible tone setting.
3. Use  to highlight the audible tone status.
4. Press  **Choice**.
5. Use   to highlight the desired enable or disable status.
6. Press  to accept your selection.

Remote Lights, Messages, and Audible Tones

The remote indicates various states by flashing light-emitting diodes (LEDs) and emitting audible tones, as described in Table 2-6.

Table 2-6. Status Indications from the Remote

Status	Remote Indications
Power on self-test passed.	The unit beeps and all LEDs flash in sequence.
Power on self-test failed.	The unit beeps and the fail LED flashes continuously.
Main unit is running a test.	Testing LED is on. Pass and fail LEDs flash as tests pass or fail.
Previous test passed.	Pass LED turns on for 15 seconds.
Previous test failed.	Fail LED turns on for 15 seconds.
Talk mode is active.	Talk LED turns on.
Battery voltage is low.	The unit beeps and the low-battery LED flashes continuously.
Battery voltage is too low to operate.	The unit beeps and the low-battery LED is on continuously.
Overvoltage condition detected on cable under test.	<p>The unit beeps and all LEDs flash continuously.</p> <p style="text-align: center;">Caution</p> <p>To avoid damage to the remote, disconnect the cable immediately if an overvoltage condition occurs.</p>

Remote Communication Error

If the main unit detects a communication problem with the remote, the following message appears on the main unit: **REMOTE communication error**. This message means that the REMOTE data cannot be transmitted to the main unit, usually because the cabling is defective. To verify proper remote operation, run a self-test as described in the earlier section “Performing a Self-Test.”

Battery Status

The test tool displays a message when its battery voltage or the remote battery voltage is low. Table 2-7 shows the battery status messages and what you should do if a battery message appears.

When you turn on the remote, the LEDs briefly indicate the battery charge level. All five LEDs light up if the battery is fully charged; fewer indicate partial charge.

DSP-4300 test tools show the battery status on the Autotest display. If the main unit is connected to a remote, the test tool also shows the approximate number of Autotests you can run with the currently-selected test standard. This number is based on the battery with the lower charge level.

Note

*To ensure continued operation while charging the battery, always connect the ac adapter/charger when the message **WARNING RECHARGEABLE BATTERY VOLTAGE IS LOW** appears.*

Table 2-7. Battery Status Messages

Message Displayed	What You Should Do
WARNING RECHARGEABLE BATTERY VOLTAGE IS LOW.	Connect the ac adapter/charger.
RECHARGEABLE BATTERY VOLTAGE IS TOO LOW TO OPERATE.	Turn the test tool off and connect the ac adapter/charger. If the tool does not operate when you turn it on, turn it off again and allow the battery to charge for about 30 minutes.
WARNING REMOTE BATTERY VOLTAGE IS LOW.	Connect the ac adapter/charger to the remote.
WARNING REMOTE BATTERY VOLTAGE IS TOO LOW TO OPERATE.	Connect the ac adapter/charger to the remote. You might need to charge the battery for a short time before the remote will operate.
INTERNAL DATA STORAGE BATTERY VOLTAGE IS LOW.	Have the lithium battery replaced at a Fluke Networks Service Center.

Battery Status Display

To see the charge level of the main unit's NiMH battery, turn the rotary switch to SPECIAL FUNCTIONS; then select **Battery Status**. To see the charge level of the remote's battery, connect the remote to the main unit; then use  to toggle the display.

Conditioning the Battery

The battery status is more accurate when the battery is properly conditioned. The test tool includes a battery conditioning feature. To condition the batteries, proceed as follows:

1. Connect the main and remote units together with a calibration module, or with LIA adapters and an RJ45 patch cord or a cable.
2. Connect ac adapters to both units.
3. Turn on the remote.
4. Press and hold  while turning on the main unit. Release the key when the display goes blank.

The conditioning function discharges then charges the battery. This may take several hours, depending on the battery status when conditioning starts. You can interrupt the conditioning if necessary. The ac power LEDs on the test tool and remote turn green when conditioning is complete.

Chapter 3

Autotest

Chapter 3 provides the following information:

- Instructions and test result descriptions for an Autotest on twisted pair cabling.
- Instructions and test result descriptions for an Autotest on coaxial cabling.
- Instructions for saving Autotest results.

Autotest Softkeys

Note

New features may be available with software upgrades. Visit the Fluke Networks website at www.flukenetworks.com or contact your Fluke Networks representative for information on upgrades.

The following softkey functions are active on various Autotest screens.

1 or **2** **View Result:** **1** shows the results of the last Autotest run. **2** shows detailed test results regarding the highlighted cable pair or pairs.

3 **View Plot:** Press to see a frequency response plot of the test results. Plot data is available for the NEXT, ELFEXT, attenuation, ACR, RL, PSNEXT, PSELFEXT, and PSACR tests.

2 **Next Pair,** **2** **Next Pairs:** Press to see the detailed results or the plot for the next cable pair or pairs tested.

4 or **2** **Memory:** Press to see the number of Autotests stored and the number of remaining memory location. If a cable ID list function, such as auto sequence, is enabled, the display also shows the cable ID range, the total number of IDs, and the number of IDs available.

Autotest on Twisted Pair Cabling

The procedures for an Autotest on shielded and unshielded twisted pair cabling are the same. The test tool tests shield continuity if shielded cable was selected and the shield test enabled when the cable type was selected in SETUP.

To run the Autotest on twisted pair cabling, refer to Figures 3-1 through 3-3 and proceed as follows:

1. Attach the appropriate link interface adapters to the main and remote units. Refer to the table in the appendix.
2. Turn on the remote.
3. Connect the remote to the far end of the cable link. For channel testing, connect using the network equipment patch cord.
4. Turn the rotary switch on the main unit to AUTOTEST.
5. Verify that the settings displayed are correct. You can change these settings in the SETUP mode.
6. Connect the main unit to the near end of the cable link. For channel testing, connect using the network equipment patch cord.
7. Press **TEST** to start the Autotest.

Notes

Pressing **TEST** when the previous Autotest was not saved causes the test tool to display a warning message. In this case, you can either save the results of the previous test by pressing **SAVE** or delete the results and start a new Autotest by pressing **TEST**.

If a remote is not connected, the test tool displays the message **SCANNING FOR SMART REMOTE** and does not run the Autotest until a remote is connected.

If the calibration message appears, refer to “Calibrating the Test Tool” in Chapter 6 for complete calibration instructions.

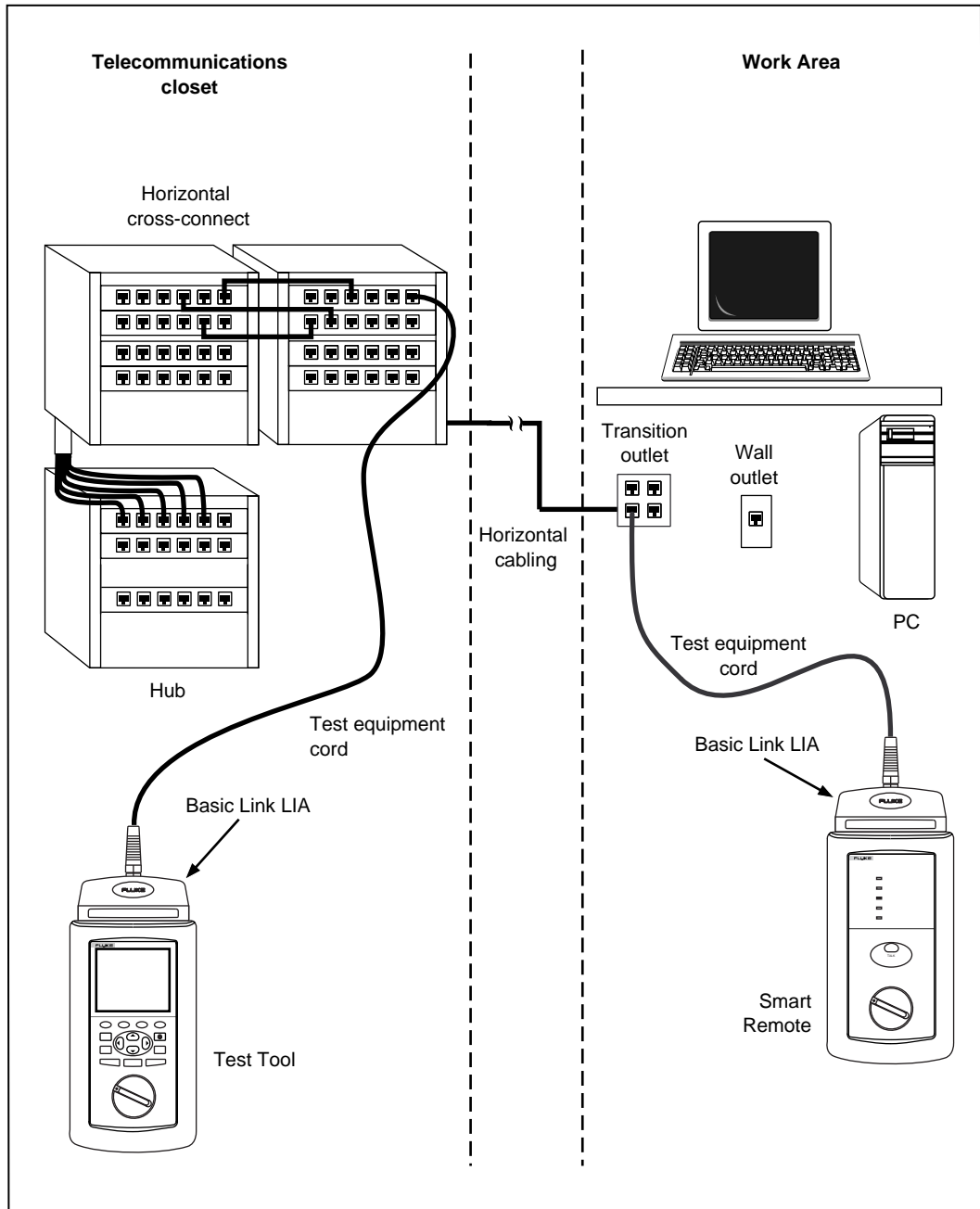
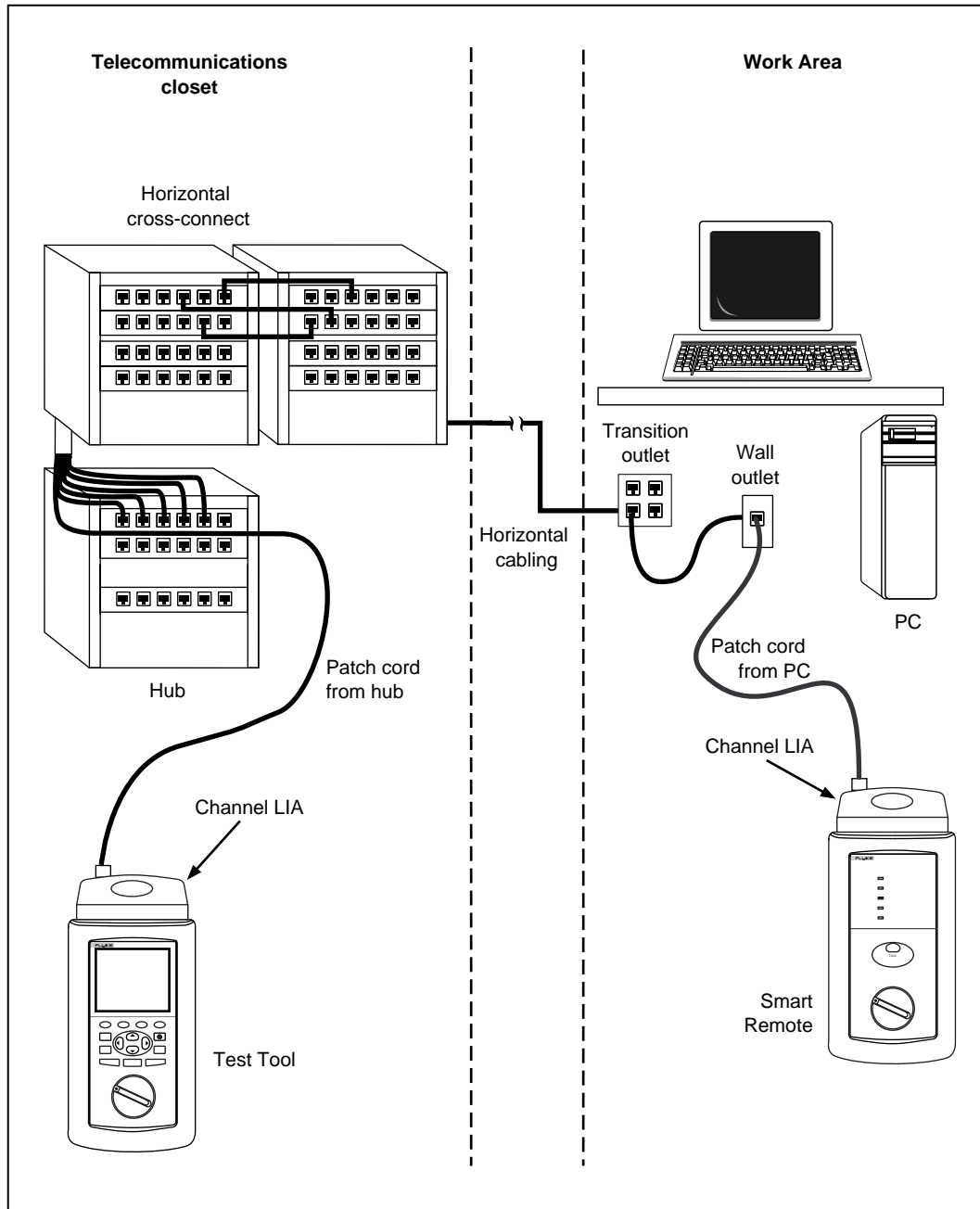

Figure 3-1. Typical Test Connections for a Basic Link

oy68f.eps



oy03f.eps

Figure 3-2. Typical Test Connections for a Channel

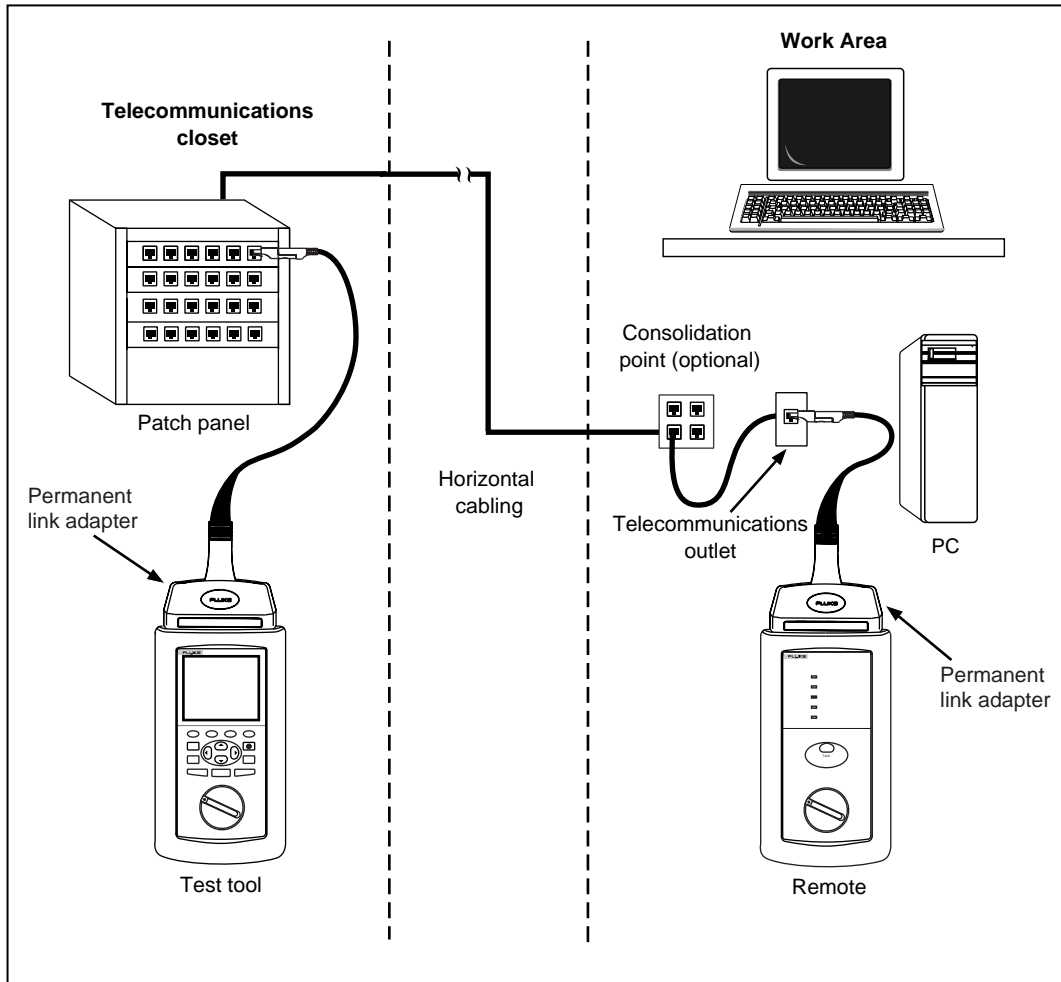

Figure 3-3. Typical Test Connections for a Permanent Link

oy84f.eps

Link Performance Grade Result (Headroom)

When an Autotest is complete, the display shows the overall result (pass or fail) and the headroom value. Headroom is the smallest difference found between the NEXT measurements and their limits. This number serves as a figure of merit that reflects the overall performance of the link. Larger headroom values correspond to better cabling performance.

To pass or fail cabling based on a minimum headroom value, enter the minimum value as part of a custom test standard (see Chapter 6).

On a DSP-4300 test tool, you can choose to see NEXT or the worst margin as the headroom value by selecting HEADROOM in SETUP. The worst margin is the measurement that came closest to failing or exceeded the limit by the greatest amount.

Worst Margin and Worst Value Results

Worst margin and worst value results are shown for frequency-dependent tests such as NEXT, RL, ELFEXT, and ACR. Worst margin results are measurements that came closest to the limit, or that exceeded the limit by the greatest amount. Worst value results are the lowest measurements found, which may not necessarily come closest to the limit.

Worst margin results for attenuation are not required by any test standard and are not reported.

Automatic Diagnostics

If an Autotest fails, you can press **FAULT INFO** to see more specific information on the cause of the failure. Figure 3-4 shows examples of automatic diagnostics displays for a NEXT failure and an open pin failure.

The arrow in the diagram at the top of the display shows the location of the failure. The bottom half of the display describes the failure and suggests ways to fix the fault. When appropriate, softkeys let you see the plot or plots relevant to the failure. If more than one fault was found, you can use the **4 Next Fault** and **3 Prev Fault** softkeys to scroll through the diagnostics displays.

See Chapter 4 for information on the HDTDR™ and HDTDx™ plots.

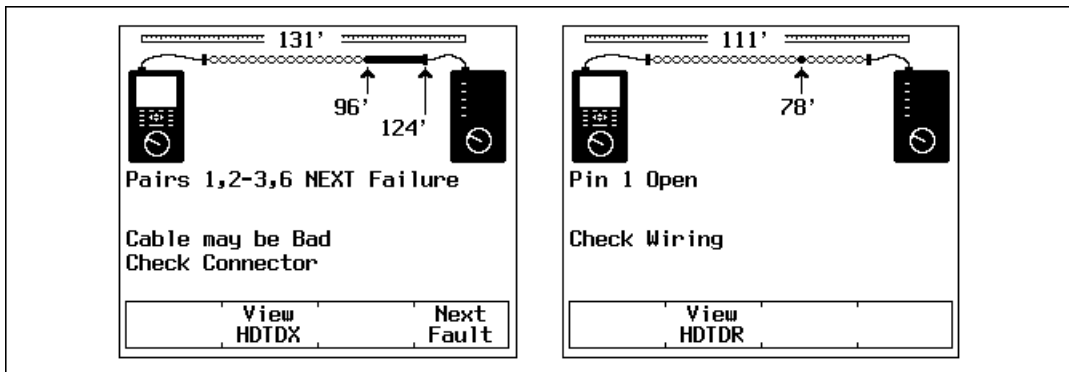

oy09c.bmp

Figure 3-4. Examples of Automatic Diagnostics Displays

Autotest Results for Twisted Pair Cabling

To see detailed results from a test, press **1** **View Result**, use **▼** **▲** to highlight the test on the main Autotest menu; then press **ENTER**.

Note

The tests run during an Autotest on twisted pair cabling depend on the test standard selected. Tests not applicable to the selected test standard are not run or displayed. For a list of the tests and limits associated with common test standards, visit the Fluke Networks website at www.flukenetworks.com.

Wire Map Test

The wire map test tests and displays the wire connections between the near and far ends of the cabling on all four pairs. Shield continuity is also tested if a shielded cable was selected and the shield test enabled when the test standard was selected. The pairs tested are those defined by the selected test standard. Table 3-1 shows examples of wire map displays.

If the wire map test passes, the Autotest continues. You can view the wire map test results when the Autotest is complete. If the wire map test fails, the Autotest halts and the wire map screen appears with the word **FAIL**. You can then save the wire map results by pressing **SAVE**. To continue the Autotest, press **4** **Continue Test**.

Table 3-1. Wire Map Displays

Wire Map Condition	Display	Description
Correct wiring	<pre> 1-----1 2-----2 3-----3 6-----6 4-----4 5-----5 7-----7 8-----8 5-----5 </pre>	Cable wiring is correct. Shield (5) shown only if required by selected test standard.

Table 3-1. Wire Map Displays (continued)

Wire Map Condition	Display (only affected pairs shown)	Description
Crossed wires	<pre> 1-----1 2-----2 3-----3 6-----6 </pre>	A wire in the 1,2 pair is crossed with a wire in the 3,6 pair. Wiring does not form a recognizable circuit.
Reversed pairs	<pre> 1-----1 2-----2 3-----3 6-----6 </pre>	Wires 1 and 2 are crossed.
Crossed pairs	<pre> 1-----1 2-----2 3-----3 6-----6 </pre>	Pairs 1,2 and 3,6 are crossed.
Short	<pre> 1-----1 2-----2 3-----3 6-----6 </pre>	Wires 1 and 3 are shorted. You can use the HDTDR test to locate the short.
Open	<pre> 1-----1 2-----2 3-----3 6-----6 </pre>	Wire 1 is open near the main unit. You can use the HDTDR test to locate the open.
Split pair	<pre> 3-----3 6-----6 4-----4 5-----5 </pre>	A wire in the 4,5 pair is twisted with a wire in the 3,6 pair. You can use the HDTDX analyzer to locate the split pair.

Resistance

The resistance test measures the dc loop resistance for each cable pair. The resistance results screen displays the resistance, limit, and pass/fail result for each cable pair. A **PASS** result means that the measured resistance is less than the limit. A **FAIL** result means that the measured resistance exceeds the limit.

Length

The length test measures the length of each cable pair tested. The main Autotest results screen shows the length of the cable pair having the shortest electrical delay. The length results screen displays the length, limit, and pass/fail result for each cable pair. Length is displayed in meters or feet. You can change the length units in the SETUP mode, as described in “Selecting a Length Unit” in Chapter 2.

Notes

A 2 to 5 percent difference in measured length between twisted pairs is typical. This difference is due to differences in the number of twists in the cable pairs.

Differences between measured and actual values of cable length can be caused by variations in the cable’s NVP value. NVP values can vary among cable types, lots, and manufacturers. To ensure maximum accuracy of length measurements, perform an NVP calibration as described in Chapter 6.

A **PASS** result means that the measured length is within the specified limit for the selected test standard. A **FAIL** result means that the measured length exceeds the limit.

Propagation Delay and Delay Skew

Propagation delays are the times taken in nanoseconds for a test pulse to travel the length of each cable pair.

Delay skews are the differences in propagation delays between the shortest delay, which is displayed as 0 ns, and the delays of the other cable pairs.

The propagation delay and delay skew results show a limit if the test is required by the selected test standard. If the test is not required, the results always show **PASS**.

Characteristic Impedance

The characteristic impedance test determines the approximate characteristic impedance of each cable pair.

Note

*Impedance measurements require a cable at least 5 m (16 ft) long.
Cables shorter than this length will always pass the impedance test.*

A **PASS** result means that the measured impedance is within the specified limit for the selected test standard. A **FAIL** result means that the measured impedance exceeds the specified limit, or an impedance anomaly is detected.

A **Warning** result means that the measured impedance exceeds test limits, or an anomaly is detected, but the characteristic impedance test is not required by the selected test standard. The warning result causes a warning to appear as the test summary result in printed reports.

The test tool reports an anomaly if 15 % or more of the test signal is reflected. Press  to see where the anomaly was detected. The HDTDR test results show both the location and size of the anomaly.

Attenuation (Insertion Loss)

The attenuation test measures the loss of signal strength over the length of the cabling.

The first attenuation results screen shows the cable pairs tested, the worst-case attenuation margin found, and a **PASS** or **FAIL** result for each pair.



To see detailed results for the cable pairs, use   to highlight a cable pair, then press  **View Result**. Table 3-2 describes the items on the attenuation results screen.

Table 3-2. Items on the Attenuation Results Screen

Item	Description
Pair	The cable pair relevant to the results.
Result	The overall result for the test. A PASS result means that measured attenuation is lower than the specified limit for the selected test standard. A FAIL result means that the measured attenuation is higher than the specified limit.
Attenuation	If the test passed, this value is the highest measured attenuation. If the test failed, this value is the highest measured attenuation that exceeds the test limits.
Frequency	If the test passed, this frequency is where the highest measured attenuation occurred. If the test failed, this is where the highest failing value of attenuation occurred.
Limit	The highest attenuation value acceptable at the frequency shown. This value is based on the maximum allowable cabling length.
Margin	The difference between the worst-case attenuation and the limit. A positive number means that the measured attenuation value is lower than the limit. A negative number means that the attenuation is higher than the limit.

Pressing **3** **View Plot** produces the attenuation plot screen. Figure 3-5 describes an example of the screen.

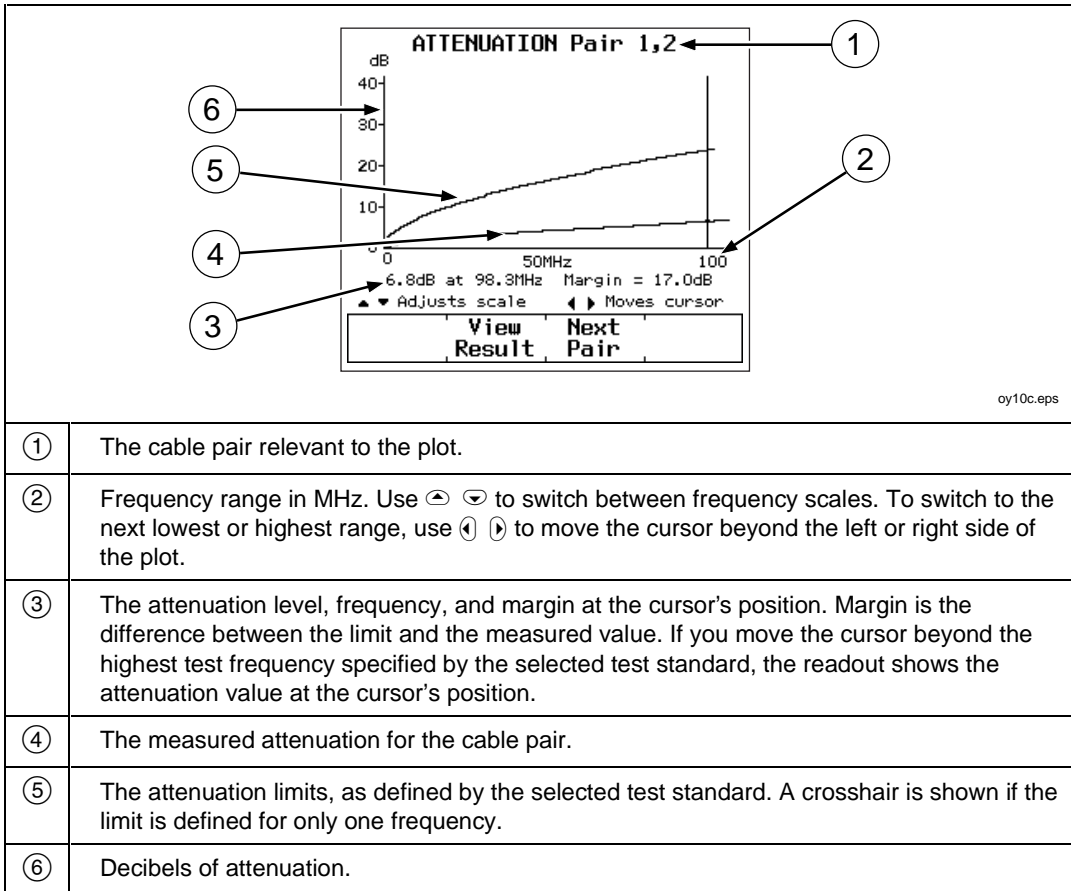





Figure 3-5. The Attenuation Plot Screen

NEXT Test

The NEXT test measures the crosstalk between cable pairs at the near end of the cabling. This crosstalk value is expressed as the difference in amplitude (in dB) between the test signal and the crosstalk signal. NEXT is measured from both ends of the cabling over a frequency range defined by the selected test standard.

The first NEXT screen displays the cable pairs tested, the worst-case NEXT margin, and the test result for each set of pairs.

To see detailed results for the cable pairs, use   to highlight the pairs; then press  **View Result**. Table 3-3 describes the items on the NEXT results screen.

For ISO/IEC 11801-2002 and EN50173:2002 standards, NEXT is not evaluated where attenuation at the same frequency is less than 4 dB.

Table 3-3. Items on the NEXT Results Screen

Item	Description
Pairs	The cable pairs relevant to the results.
Result	The overall result for the NEXT test. A PASS result indicates that the NEXT between the cable pairs was higher than the specified NEXT for the selected test standard. A FAIL result indicates that the NEXT was lower than specifications.
NEXT	The worst margin and worst NEXT. The worst margin is the NEXT value that is closest to falling below specifications, or the value that exceeds specifications by the greatest amount. The worst NEXT is the lowest NEXT value measured.
Frequency	The frequencies where the worst margin and worst NEXT values occurred.
Limit	The lowest NEXT values acceptable for the frequencies above.
Margin	The differences between the NEXT values and the limits. A positive number means that the measured NEXT value is higher than the limit (PASS). A negative number means that the NEXT is lower than the limit (FAIL).

Pressing **3** **View Plot** produces the NEXT plot screen. Figure 3-6 describes an example of the screen.

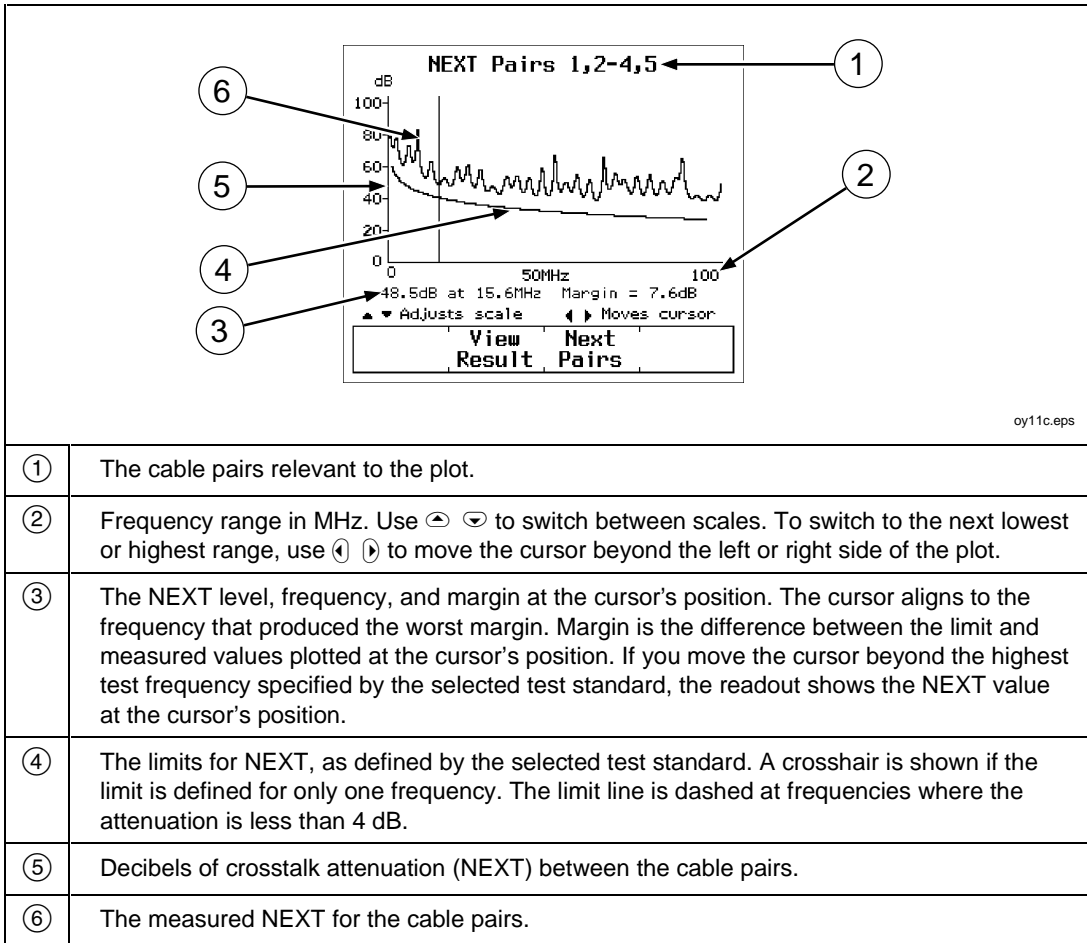



Figure 3-6. The NEXT Plot Screen

NEXT@REMOTE

The NEXT@REMOTE test and its results are identical to the NEXT test described above, except that the NEXT@REMOTE measurements are taken from the remote end of the cabling.

ELFEXT Test

The ELFEXT (equal level far-end crosstalk) test calculates the ratio of FEXT to attenuation for each cable pair. To determine ELFEXT, the main unit first measures FEXT by generating a signal at the far end of the cabling and measuring the resulting crosstalk at the near end of the cabling. ELFEXT is calculated as the difference (in dB) between the measured FEXT and attenuation values. If the ELFEXT test fails, you can use the  key to locate sources of crosstalk on the cabling.

Because ELFEXT values from either end of a cable are virtually identical, a ELFEXT@REMOTE test is not required. (See Chapter 7 for more information.)

The first ELFEXT screen displays the cable pairs tested, the worst-case ELFEXT margin, and the test result for each set of pairs.



To see detailed results for the cable pairs, use   to highlight the pairs; then press  **View Result**. Table 3-4 describes the items on the ELFEXT results screen.

Table 3-4. Items on the ELFEXT Results Screen

Item	Description
Pairs	The pairs used in calculating the ELFEXT result. The pair not listed as the Atten. Pair produced the FEXT used in the ELFEXT calculation
Atten. Pair	The pair that produced the attenuation value used in the ELFEXT calculation.
Result	The overall result for the ELFEXT test. A PASS result means that the calculated ELFEXT is higher than the value specified for the selected test standard. A FAIL result means that the calculated ELFEXT is lower than the specified value.
ELFEXT (dB)	The worst margin and worst ELFEXT. The worst margin is the ELFEXT value that is closest to falling below specifications, or the value that exceeds specifications by the greatest amount. The worst ELFEXT is the lowest ELFEXT value measured.
Frequency	The frequencies where the worst margin and worst ELFEXT values occurred.
Limit	The lowest ELFEXT values acceptable for the frequencies above.
Margin	The difference between the ELFEXT values and the limits. A positive number means that the ELFEXT is higher than the limit. A negative number means that the ELFEXT is lower than the limit.

Pressing **3** **View Plot** produces the ELFEXT plot screen. Figure 3-7 describes an example of the screen.

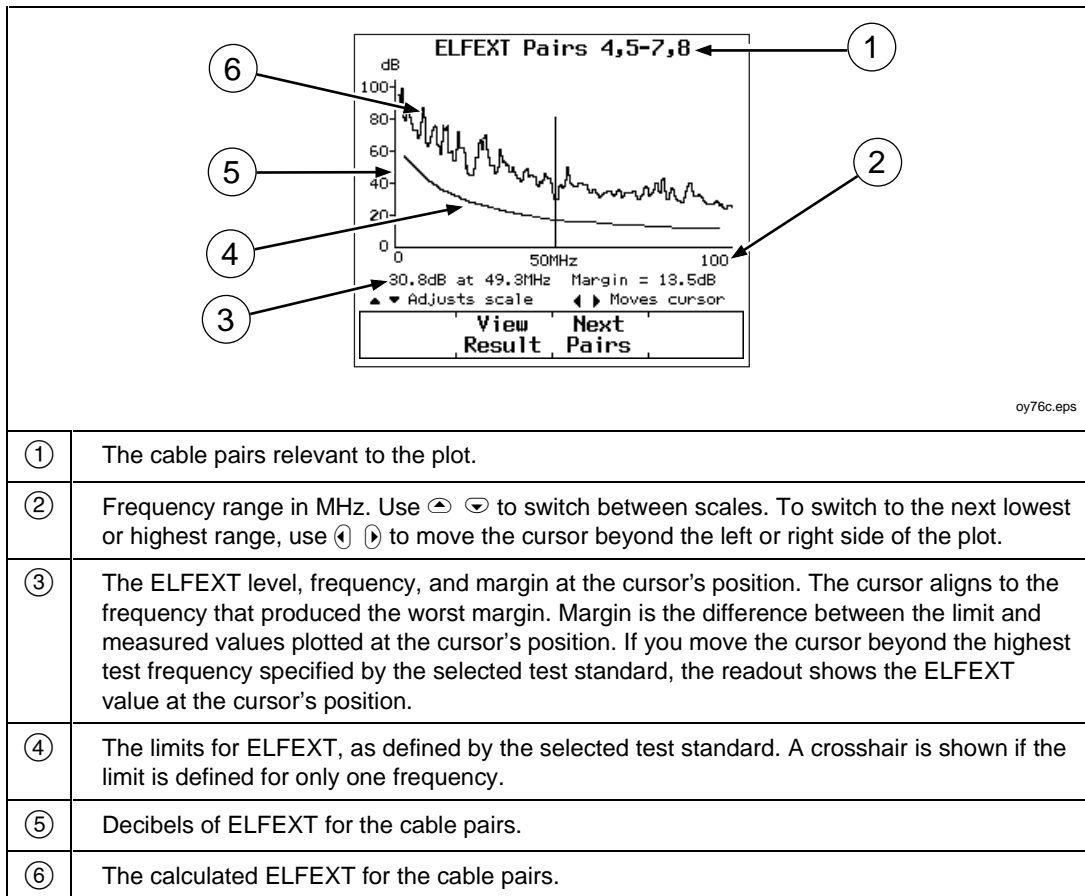





Figure 3-7. The ELFEXT Plot Screen

ACR

The ACR test calculates the ratio of attenuation to crosstalk (ACR) for each combination of cable pairs. ACR is expressed as the difference (in dB) between the measured NEXT and attenuation values. ACR is calculated using values obtained from the NEXT and attenuation tests.

The first ACR results screen shows the NEXT pairs and attenuation pair used to calculate the ACR result, the worst-case ACR margin, and a **PASS** or **FAIL** result for each set of pairs.

To see detailed results for the cable pairs, use   to highlight the pairs; then press  **View Result**. Table 3-5 describes the items on the ACR results screen.

For ISO/IEC 11801-2002 and EN50173:2002 standards, ACR is not evaluated where attenuation at the same frequency is less than 4 dB.

Table 3-5. Items on the ACR Results Screen

Item	Description
Pairs	The pairs used in calculating the ACR result. The pair not listed as the Atten. Pair produced the NEXT used in the ACR calculation.
Atten. Pair	The pair that produced the attenuation value used in calculating the ACR result.
Result	The overall result for the ACR test. A PASS result means that the calculated ACR is higher than the value specified for the selected test standard. A FAIL result means that the calculated ACR is lower than the specified value.
ACR (dB)	The worst margin and worst ACR. The worst margin is the ACR value that is closest to falling below specifications, or the value that exceeds specifications by the greatest amount. The worst ACR is the lowest ACR value measured.
Frequency	The frequencies for the worst margin and worst ACR values.
Limit	The lowest ACR values acceptable for the frequencies above.
Margin	The differences between the ACR values and the limits. A positive number means that the worst-case ACR is higher than the limit. A negative number means that the worst-case ACR is lower than the limit.

Pressing **3** **View Plot** produces the ACR plot screen. Figure 3-8 describes an example of the screen.

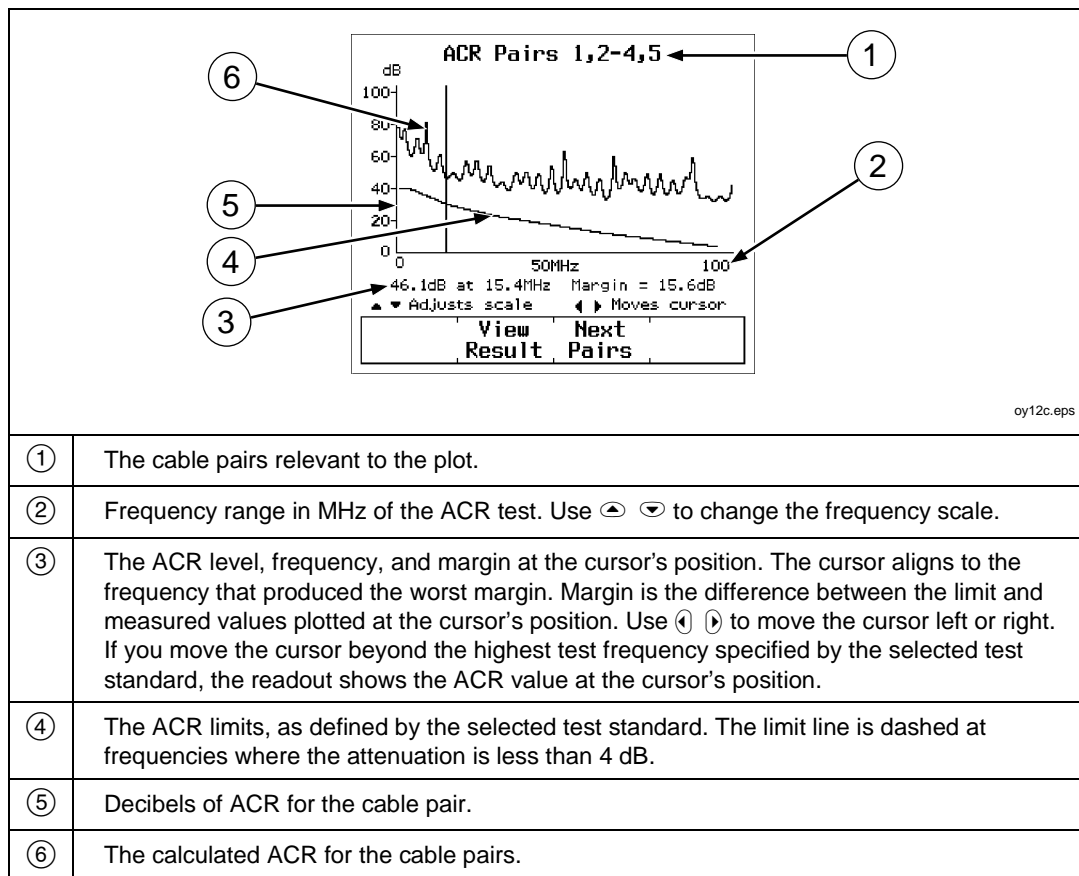





Figure 3-8. The ACR Plot Screen

ACR@REMOTE

The ACR@REMOTE test is identical to the ACR test, except that the ACR values are calculated using NEXT@REMOTE values.

Return Loss (RL)

The RL test measures the difference between a test signal’s amplitude and the amplitude of signal reflections returned by the cabling. The results of the RL test indicate how well the cable’s characteristic impedance matches its rated impedance over a range of frequencies.

The first RL results screen shows the cable pairs tested, the worst-case RL margin, and a **PASS** or **FAIL** result for each pair. To see detailed results for the cable pairs, use   to highlight a pair; then press  **View Result**. Table 3-6 describes the items on the RL results screen.

For TIA and ISO test standards, RL is not evaluated where attenuation at the same frequency is less than 3 dB.

Table 3-6. Items on the RL Results Screen

Item	Description
Pair	The cable pair relevant to the results.
Result	The overall result for the RL test. A PASS result means that the measured RL is lower than the specified limit for the selected test standard. A FAIL result means that the measured RL is higher than specified limit.
RL	The worst margin and worst RL. The worst margin is the RL value that is closest to falling below specifications, or the value that exceeds specifications by the greatest amount. The worst RL is the lowest RL value measured.
Frequency	The frequencies where the worst margin and worst RL values occurred.
Limit	The lowest acceptable RL values for the frequencies above.
Margin	The differences between the RL values and the limits. A positive number means that the worst-case RL is better than the limit. A negative number means that the worst-case RL exceeds the limit.

Pressing **3** **View Plot** produces the RL plot screen. Figure 3-9 describes an example of the screen.

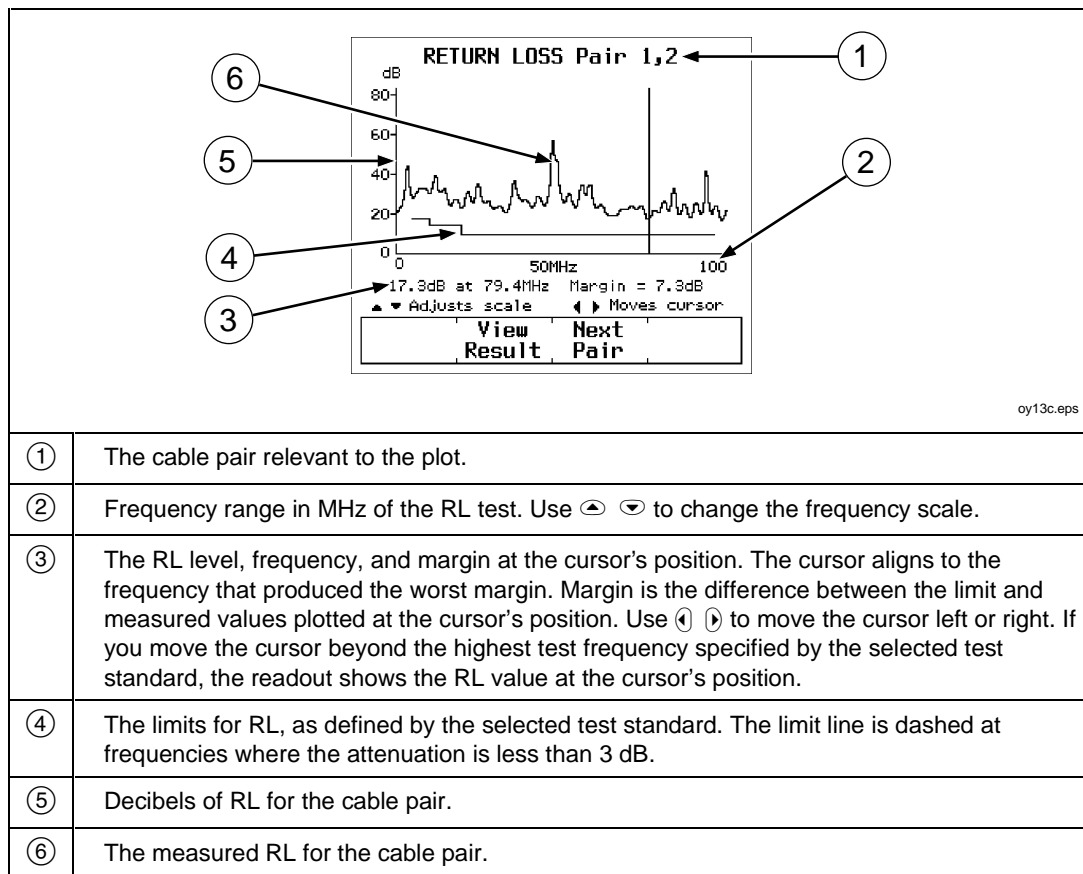

Figure 3-9. The RL Plot Screen

RL@REMOTE

The RL@REMOTE test is identical to the RL test, except that the RL values are measured from the remote end of the cabling.

PSNEXT (Power Sum NEXT) and PSNEXT@REMOTE

The PSNEXT results show how much each cable pair is affected by the combined NEXT from the other pairs. PSNEXT is expressed as the difference in amplitude (in dB) between the crosstalk received on a cable pair and a test signal transmitted on the other pairs.

PSNEXT is calculated from NEXT values. PSNEXT@REMOTE is calculated from NEXT@REMOTE values. The descriptions of the results are the same as for NEXT results, except that they show the sum effect of NEXT on a cable pair.

PSELFEXT (Power Sum ELFEXT)

The PSELFEXT results show how much each cable pair is affected by the combined FEXT from the other pairs. To calculate PSELFEXT for a cable pair, the test tool subtracts the pair's attenuation from the combined FEXT of the other pairs. The descriptions of the results are the same as for ELFEXT results, except that they show the sum effect of FEXT on a cable pair.

PSACR (Power Sum ACR) and PSACR@REMOTE

PSACR results show the ratio of each wire pair's attenuation to the combined crosstalk received from the other pairs. The test tool calculates PSACR values by subtracting a pair's attenuation from its PSNEXT value. PSACR@REMOTE values are calculated using PSNEXT@REMOTE values.

Autotest on Coaxial Cabling

To run an Autotest on coaxial cabling, refer to Figure 3-10 and proceed as follows:

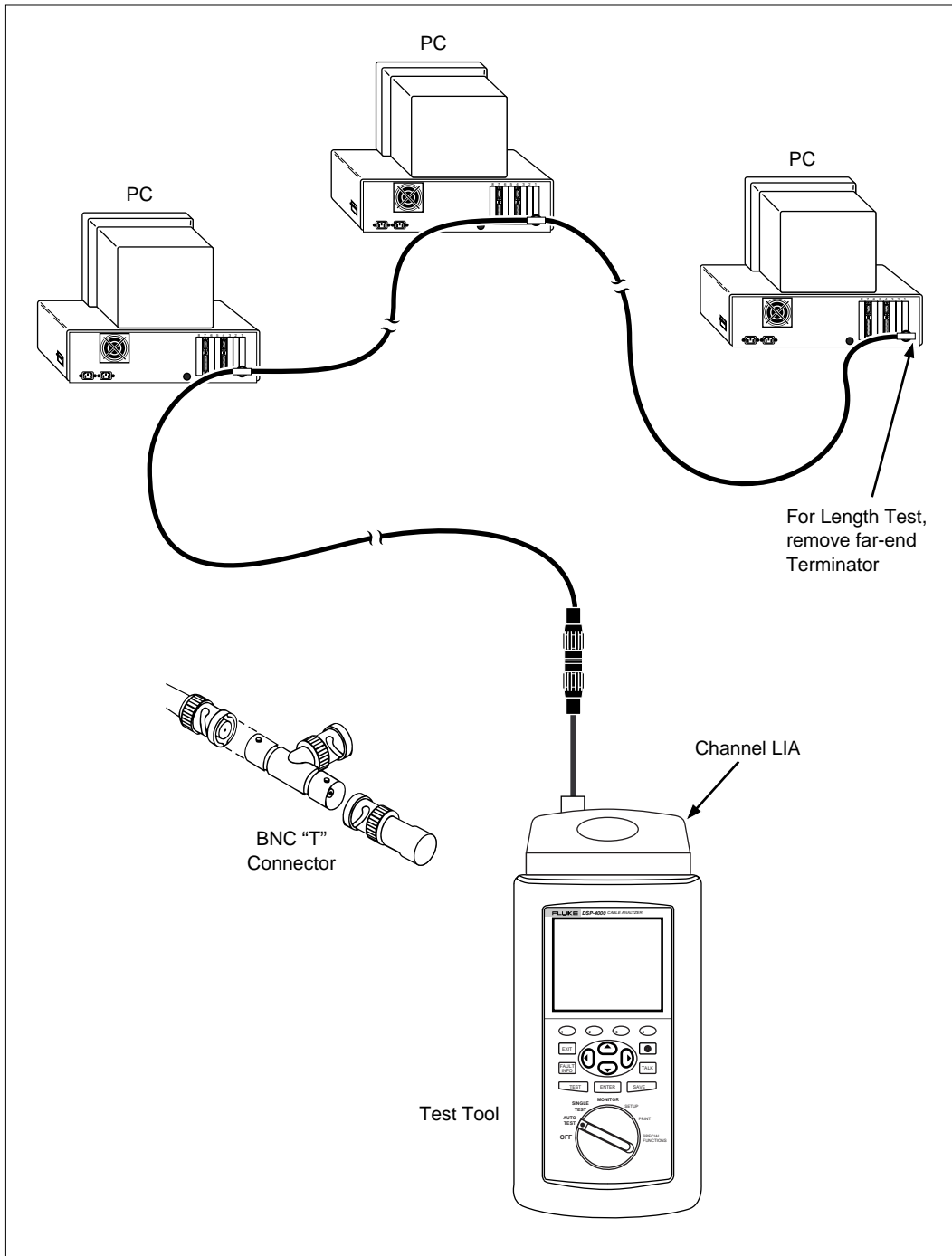

Figure 3-10. Autotest Connections for Coaxial Cabling

oy04f.eps

1. Attach a channel link interface adapter to the main unit.
2. Turn off any PC nodes connected to the cabling you are testing.
3. If you want the Autotest to report cabling length, remove the terminator from the far end of the cabling.
4. Turn the rotary switch to AUTOTEST.
5. Verify that the test standard and cable type displayed are correct. You can change these settings in the SETUP mode.
6. Remove the terminator from the near end of the coaxial cabling. Use the RJ45 to coaxial adapter to connect the test tool to the cabling.
7. Press to start the Autotest.

Autotest Results for Coaxial Cabling

An Autotest on coaxial cabling performs the following tests:

Characteristic Impedance

Note

Impedance measurements require cabling at least 5 m (16 ft) long. Terminated cabling shorter than this length will always pass the impedance test. Unterminated cabling shorter than this length will always fail the impedance test.

The characteristic impedance test determines the approximate characteristic impedance for the cable. A **PASS** result means that the impedance is within the limit specified by the selected test standard. A **FAIL** result means that the impedance exceeds the limit. You can use the HDTDR test to plot the locations and sizes of all impedance anomalies on the cabling.

Resistance

The resistance test measures the loop resistance of the cabling and the terminator. If a terminator is not connected or if the cabling is open, the resistance value is reported as **OPEN**. If the cabling or the terminator is shorted, the resistance value is reported as near 0 Ω . Resistance values over 400 Ω are reported as **OPEN**.

Length

Note

Because a cable terminator eliminates signal reflections in coaxial cabling, the test tool cannot measure the length of terminated coaxial cabling.

The length test measures the length of the cabling when a terminator is not connected. If a terminator is connected, the result of the length test is reported as **NO REFLECTION**.

A **PASS** result means that the measured length is within the limit specified by the selected test standard. A **FAIL** result means that the measured length exceeds the limit.

Notes

Differences between measured and actual values of cabling length can be caused by variations in the cable's NVP value. NVP values can vary among cable types, lots, and manufacturers. To ensure maximum accuracy of length measurements, perform an NVP calibration as described in Chapter 6.

Anomaly

This result is shown at the bottom of the screen only if an impedance anomaly is detected. The test tool reports an anomaly if 10% or more of the test signal is reflected. The result shows the distance to the largest anomaly detected.

Saving Autotest Results

A DSP-4000 test tool can store the results of 500 or more Autotests, depending on the test standard used. The test tool stores worst-case margins and worst-case values for most frequency-dependant tests.

A DSP-4100 or DSP-4300 test tool with STORE PLOT DATA enabled can store at least 250 Autotests in graphical format on a 16 MB memory card, depending on the standard used. A DSP-4300 test tool stores results in internal memory if no card is present. More Autotests can be saved if plot data is not included. If STORE PLOT DATA is enabled, the saved Autotest results include plots from tests such as the attenuation and NEXT tests. HDTDR and HDTDX plots are also saved. Saving the plot data lets you include plots on reports uploaded to a PC and printed with LinkWare software.

Caution

The test tool may not be able to read or store test results on a memory card that contains other types of data (such as music files).

If you used a permanent link test standard for the Autotest, the model number of the personality module used on the permanent link adapter is saved with the Autotest results and appears on printed test reports.

You can save the results from an Autotest anytime after the Autotest is complete, but before another Autotest or a Single Test is started.

A cable identification (cable ID) is assigned to each Autotest you save. The screen you use for entering a cable ID depends on which cable ID function is enabled.

Saving Results with Auto Sequence Disabled

1. If you want to check or edit the custom header, operator name, or site name to be saved with your results, turn the rotary switch to SETUP; then select **REPORT IDENTIFICATION**. See "Editing the Report Identification" in Chapter 2 for details.
2. After an Autotest is complete, press **SAVE**. The test save screen appears, as shown in Figure 3-11.
3. Use the appropriate editing keys to enter a cable identification name for the test results you are saving. Refer to Figure 3-11.
4. Press **SAVE** to store the test results with the cable identification displayed. A confirmation screen appears for about 2 seconds.

A warning screen appears if you try to save a test report with the same name as a previously saved report. On a DSP-4000 test tool, pressing **SAVE** saves the new report with the duplicate name, but with the current date and time. The DSP-4100 and DSP-4300 test tools do not let you save reports with duplicate IDs. On any model, pressing **Edit I.D.** or **EXIT** lets you change the report's name.

oy15c.eps

①	The characters you can use to make a name for the test results you are saving. To add characters to the name, use the ← → and ↕ ↔ keys to highlight characters in the list, then press ENTER .
②	The date and time when the Autotest was completed.
③	The default name assigned to the results from the most recently completed test.
④	The remaining number of locations available for storing Autotest results.
⑤	Softkey for moving the cursor to edit characters in the middle of the cable identification. To move the cursor back to the right, press ← until the cursor wraps around.
⑥	Softkeys for incrementing or decrementing an alphanumeric character highlighted in the cable identification.
⑦	Softkey for deleting the character left of the highlighted character in the cable name.

Figure 3-11. Saving Autotest Results (Auto Increment and Auto Sequence Disabled)

Saving Results with Auto Sequence Enabled

The following steps assume you have already enabled the auto sequence function and entered a start ID and end ID, which define the range of cable IDs available. See “Setting Up Cable IDs” in Chapter 2 for details.

1. If you want to check or edit the custom header, operator name, or site name to be saved with your results, turn the rotary switch to SETUP; then select **REPORT IDENTIFICATION**. See “Editing the Report Identification” in Chapter 2 for details.
2. After an Autotest is complete, press **SAVE**. A list of cable IDs is shown. The list includes the cable IDs for all saved Autotest results. IDs used for previously-saved results are marked with a “\$”. Unused IDs are listed after used IDs. The timestamp that will be saved with the Autotest is shown below the highlighted ID.
3. Choose a cable ID as follows:
 - To save the Autotest results with the next unused ID in the sequence, press **SAVE**.
 - To save the results with an unused ID out of sequence, use ∇ to select an unused ID; then press **SAVE**.
 - To edit a used or unused cable ID, use ∇ \blacktriangle to highlight the ID; then press **1 Edit**. Use the alphanumeric display to edit the ID (refer to the softkey descriptions in Figure 3-11); then press **SAVE**. The original ID remains in the list.
 - To create a new ID, press **2 New**. Use the alphanumeric display to edit the ID (refer to the softkey descriptions in Figure 3-11); then press **SAVE**.

If you try to save an Autotest after the last ID in the range has been used, the list of saved reports shows that no IDs are available (all are marked with a "\$"). To save additional results, set up a new range of IDs in SETUP, or use the **1** **Edit** or **2** **New** softkey as described above to create a new ID for each additional Autotest.

Saving Results with Downloaded Cable IDs (DSP-4300)

You can select a downloaded list as the source for cable IDs from the auto increment menu in SETUP. See "Selecting a List of Downloaded IDs" in Chapter 2 for details.

Saving results with downloaded cable IDs is similar to saving with auto sequence IDs. Follow steps 1 through 3 from the previous section "Saving Results with Auto Sequence Enabled".

Changing the Cable ID for a Saved Autotest Report

You can change the cable identification assigned to a saved Autotest report as follows:

1. Turn the rotary switch to SPECIAL FUNCTIONS.
2. Select **View/Delete Test Reports**.
3. Use **▼ ▲** to highlight the desired report. Press **2** **View Result**, then press **1** **View Result**.
4. Press **2** **Rename Report**. Use the editing softkeys to edit the cable identification (refer to the softkey descriptions in Figure 3-11).
5. Press **SAVE**.

If Memory is Full

If the Autotest results you save fill the last available memory location, the following message appears: **WARNING! TEST RESULT MEMORY IS NOW FULL**. If you try to save additional test results after the memory has been filled, the following message appears: **UNABLE TO SAVE TEST RESULTS. MEMORY IS FULL**.

To save additional test results, you must delete one or more test reports from memory (in SPECIAL FUNCTIONS mode) or, for a DSP-4100 or DSP-4300 test tool, put a new memory card in the test tool. Remove the memory card from a DSP-4300 test tool to save additional results in internal memory. (See the next section for details.) To transfer test reports to a PC, use the LinkWare software included with your test tool. See the online help or “Getting Started” under Help on the LinkWare menu for details.

You can see how many memory spaces are available by pressing the **Memory** softkey, which appears on several Autotest displays.

Saving Results to Internal Memory (DSP-4300)

If no memory card is present in a DSP-4300 test tool, test results are saved to internal memory. Later, when you insert a memory card, the test tool lets you choose whether or not to copy the saved results from internal memory to the memory card. After you copy the results, the test tool lets you choose to delete or retain the results in the internal memory.

Results are always saved on the memory card when one is present. When you view test reports in the SPECIAL FUNCTIONS mode, reports saved on the card are always shown when a card is present. To see the contents of the internal memory, remove the memory card.

Notes

To avoid confusion regarding the contents of the internal memory, save test results on a removable memory card whenever possible.

Copying results from the internal memory to a memory card can take up to 30 minutes. Verify that the battery has at least 25 % charge remaining or connect the ac adapter before copying the results.

The Autotest Report

With LinkWare software you can upload reports to a PC for viewing and printing. Figures 3-12 and 3-13 show examples of reports generated with LinkWare software.

You can send Autotest reports directly to a serial printer or edit the report's identification information in the PRINT mode. See Chapter 5, "Viewing and Printing Saved Reports," for complete instructions.

The overall result printed on a report can be a pass or fail, or warning. A failure of any test required by the selected test standard produces a fail result on the report summary. If required by the selected standard, a warning appears on reports for twisted pair cabling if a length, impedance, propagation delay, or delay skew test produced a warning. The warning means that the measurement exceeds its limit, but the test standard does not fail the cabling based on that measurement.

Cable ID: 0001					Test Summary: FAIL						
The Big Old Cable Company					HEADROOM: 6.2 dB (NEXT @ Remote 36-45)						
SITE: Bud's Garage					Date / Time: 07/17/2000 01:18:17pm						
OPERATOR: Fred1					Test Standard: TIA Cat 5e Channel						
Standards Version: 3.72					Cable Type: UTP 100 Ohm Cat 5e						
Software Version: 3.72					FLUKE DSP-4100 S/N: 5251965 LIA012						
NVP: 69.0% FAULT ANOMALY THRESHOLD: 15%					FLUKE DSP-4100SR S/N: 3171963 LIA012						
SHIELD TEST: N/A											
Wire Map PASS											
					Result RJ45 PIN: 1 2 3 4 5 6 7 8 S						
					RJ45 PIN: 1 2 3 4 5 6 7 8						
RJ45 PIN: 1 2 3 4 5 6 7 8											
Length		Prop. Delay		Delay Skew		Resistance		Impedance		Attenuation	
Pair	(ft)	Limit	ns	Limit	ns	Limit	ohms	Limit	ohms	Limit	Result Freq. Limit (dB) Mhz (dB)
12	76	328	112	555	3	50			109	80-120	5.5 100.0 24.0
36	75	328	111	555	2	50			107	80-120	5.6 100.0 24.0
45	76	328	112	555	3	50			108	80-120	5.5 100.0 24.0
78	74	328	109	555	0	50			109	80-120	5.2 100.0 24.0
Main Results					Remote Results						
Worst Margin		Worst Value		Worst Margin		Worst Value					
Pair	Result (dB)	Freq. Mhz	Limit (dB)	Result (dB)	Freq. Mhz	Limit (dB)	Result (dB)	Freq. Mhz	Limit (dB)	Result (dB)	Freq. Limit (dB) Mhz (dB)
RETURN LOSS FAIL											
12	14.5*	28.4	15.5	14.5	28.4	15.5	13.7*	28.2	15.5	13.7	28.2 15.5
36	14.3*	42.6	13.7	13.5	57.4	12.5	14.0*	42.4	13.8	14.0	42.6 13.7
45	14.5*	37.6	14.3	14.5	37.6	14.3	13.9*	37.4	14.3	13.9	37.4 14.3
78	16.1*	33.6	14.8	15.5	43.8	13.6	15.5*	33.6	14.8	15.3	38.4 14.2
PSNEXT											
12	39.0	61.6	30.7	36.1	99.0	27.2	37.0	93.2	27.6	37.0	93.2 27.6
36	39.2	61.2	30.8	37.7	99.0	27.2	37.1	72.6	29.4	35.5	97.4 27.3
45	39.9	61.2	30.8	38.0	85.8	28.3	35.3	96.8	27.3	35.3	96.8 27.3
78	38.9	72.2	29.5	38.6	93.2	27.6	37.6	72.2	29.5	37.2	100.0 27.1
PSACR											
12	57.8	4.5	45.3	30.7	99.0	3.2	58.0	5.1	44.1	31.8	93.2 4.5
36	58.0	5.0	44.3	32.2	99.0	3.2	58.7	4.5	45.3	30.1	97.4 3.6
45	60.0	4.5	45.3	33.1	91.4	4.9	57.8	4.7	44.8	30.0	96.8 3.7
78	56.7	8.3	39.1	33.6	93.2	4.5	65.8	2.4	51.2	32.0	100.0 3.0
NEXT											
12-36	41.2	61.6	33.7	40.6	99.0	30.2	41.9	78.0	32.0	41.9	78.0 32.0
12-45	62.7	4.6	52.6	41.8	94.0	30.5	40.0	92.8	30.6	40.0	92.8 30.6
12-78	39.2	99.0	30.2	39.2	99.0	30.2	40.0	99.2	30.2	40.0	99.6 30.1
36-45	41.5	70.8	32.6	40.5	90.8	30.8	36.5	97.0	30.3	36.5	97.0 30.3
36-78	42.2	73.4	32.4	42.2	73.4	32.4	39.8	72.8	32.4	39.8	72.8 32.4
45-78	40.6	86.2	31.2	40.6	86.2	31.2	39.6	85.8	31.3	39.6	86.0 31.2
ACR											
12-36	60.2	4.7	47.6	35.1	99.0	6.3	62.9	4.9	47.2	37.0	98.2 6.4
12-45	61.6	4.6	47.8	36.6	94.0	7.3	60.2	5.1	46.8	34.9	92.8 7.6
12-78	58.3	10.0	39.9	34.1	99.0	6.3	59.7	10.1	39.8	34.8	99.6 6.1
36-45	64.4	4.7	47.6	35.5	90.8	8.0	61.1	4.6	47.8	31.2	97.0 6.7
36-78	60.4	7.2	43.4	37.8	73.4	12.1	56.1	9.4	40.6	35.5	72.8 12.2
45-78	63.0	8.1	42.2	35.8	86.2	9.0	68.5	2.4	53.7	34.9	100.0 6.0
ELFEXT											
12-36	38.3	86.0	18.7	38.0	100.0	17.3	38.3	86.0	18.7	38.0	91.4 18.2
12-45	36.3	95.6	17.8	36.3	96.0	17.7	36.3	94.6	17.9	36.3	96.0 17.7
12-78	53.4	26.4	29.0	43.3	93.2	18.0	53.3	26.4	29.0	43.1	93.2 18.0
36-12	38.6	80.6	19.3	38.5	91.2	18.2	38.6	80.6	19.3	38.5	91.2 18.2
36-45	50.4	17.0	32.8	36.9	100.0	17.3	50.4	17.0	32.8	36.8	100.0 17.3
36-78	52.0	17.4	32.6	45.7	61.8	21.5	52.0	17.4	32.6	45.4	62.2 21.5
45-12	35.8	92.4	18.1	35.8	93.6	17.9	35.8	92.4	18.1	35.8	93.6 17.9
45-36	48.4	21.9	30.6	35.6	99.8	17.4	48.3	21.9	30.6	35.7	99.8 17.4
45-78	48.3	20.7	31.1	40.1	98.8	17.5	48.5	20.0	31.4	39.8	98.8 17.5
78-12	53.0	26.1	29.1	44.8	99.0	17.4	53.1	26.1	29.1	45.1	99.0 17.4
78-36	49.5	26.1	29.1	40.3	100.0	17.3	49.6	26.1	29.1	40.7	100.0 17.3
78-45	48.4	20.2	31.3	40.4	92.0	18.1	48.4	20.2	31.3	40.6	92.0 18.1
PSELFEXT											
12	34.0	91.6	15.2	34.0	92.0	15.1	34.0	91.6	15.2	33.9	96.4 14.7
36	32.8	100.0	14.4	32.8	100.0	14.4	47.9	17.4	29.6	34.5	100.0 14.4
45	44.8	21.5	27.8	33.3	100.0	14.4	42.8	27.0	25.8	32.4	94.2 14.9
78	44.1	26.7	25.9	38.5	98.0	14.6	44.5	26.1	26.1	37.4	97.4 14.6
* Measurement is within the accuracy limits of the instrument.											

oy82f.bmp

Figure 3-12. Autotest Report in Tabular Format



Operator: JOHN DOE
Standards Version: 4.06 Software Version: 4.06
NVP: 69.0% Fault Anomaly Threshold: 15%
Shield Test: N/A

Test Summary: **PASS**
Cable ID: ROOM123, PORT B
Headroom: 7.3 dB (NEXT 12-36)
Site: ABC BANK
Date / Time: 08/09/2000 09:06:17am
Test Standard: TIA Cat 6 Basic Link
Cable Type: UTP 100 Ohm Cat 6
FLUKE DSP-4100 S/N: 1234567 LIA081
FLUKE DSP-4100SR S/N: 0000001 LIA081

Wire Map	1 2 3 4 5 6 7 8 S
PASS	
	1 2 3 4 5 6 7 8

Length (ft), Limit 308 [Pair 12]	111
Prop. Delay (ns), Limit 518 [Pair 12]	163
Delay Skew (ns), Limit 45 [Pair 12]	7
Resistance (ohms)	
Impedance (ohms), Limit 80-120 [Pair 12]	114
Anomaly (ft)	
Attenuation (dB) [Pair 36]	12.6
Frequency (MHz)	250.0
Limit (dB)	31.8

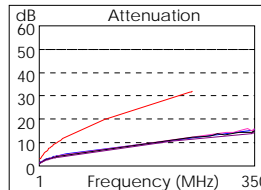
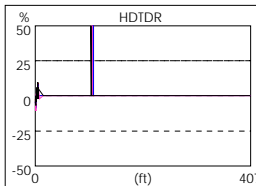

	Worst Margin		Worst Value	
	MAIN	SR	MAIN	SR
PASS				
Worst Pair	12-36	36-45	12-36	36-45
NEXT (dB)	63.4	43.2	43.8	43.2
Freq. (MHz)	13.0	242.0	222.5	242.0
Limit (dB)	56.1	35.5	36.1	35.5
Worst Pair	36	45	36	45
PSNEXT (dB)	40.7	41.7	40.7	41.7
Freq. (MHz)	223.0	242.0	223.0	242.0
Limit (dB)	33.6	33.0	33.6	33.0

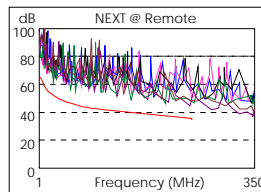
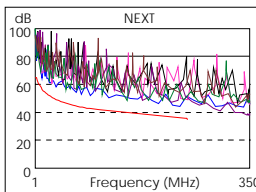

	Worst Margin		Worst Value	
	MAIN	SR	MAIN	SR
PASS				
Worst Pair	78-36	12-45	36-45	36-45
ELFEXT (dB)	28.0	30.6	27.6	27.2
Freq. (MHz)	184.0	144.5	227.5	227.5
Limit (dB)	19.9	22.0	18.0	18.0
Worst Pair	36	36	36	36
PSELFEXT (dB)	25.8	26.0	25.4	25.4
Freq. (MHz)	184.5	185.5	247.0	232.5
Limit (dB)	16.9	16.8	14.3	14.8

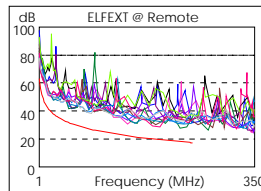
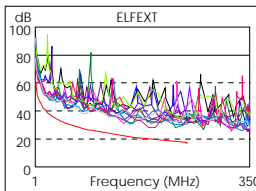

	Worst Margin		Worst Value	
	MAIN	SR	MAIN	SR
PASS				
Worst Pair	12-36	12-45	12-36	36-45
ACR (dB)	60.7	67.0	31.5	31.2
Freq. (MHz)	12.9	8.9	240.0	242.0
Limit (dB)	49.5	53.2	4.5	4.3
Worst Pair	12	12	36	36
PSACR (dB)	59.3	61.4	28.8	29.3
Freq. (MHz)	12.9	12.3	223.0	242.0
Limit (dB)	47.2	47.7	3.7	1.7

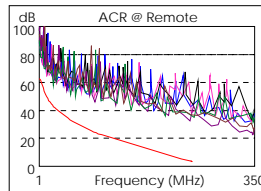
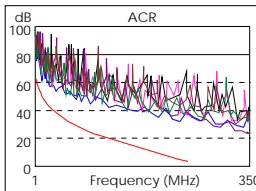

	Worst Margin		Worst Value	
	MAIN	SR	MAIN	SR
PASS				
Worst Pair	12	45	45	78
RL (dB)	21.0	20.8	18.5	17.3
Freq. (MHz)	13.2	16.6	249.0	250.0
Limit (dB)	19.0	19.0	11.3	11.3

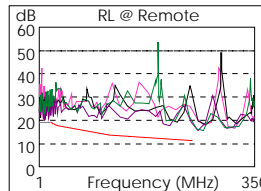
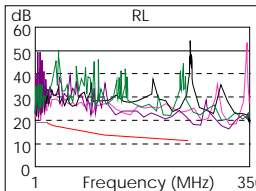

Compliant Network Standards:
10BASE-T 100BASE-TX 100BASE-T4
1000BASE-T ATM-25 ATM-51
ATM-155 100VG-AnyLan TR-4
TR-16 Active TR-16 Passive



oy81f.wmf

Figure 3-13. Autotest Report in Graphical Format

Chapter 4

Running Individual Tests

Chapter 4 provides the following information:

- Instructions for running Single Tests on twisted pair cabling.
- Descriptions of the test results produced by the HDTDTM analyzer and HDTDRTM test.
- Instructions for running Single Tests on coaxial cabling.
- Instructions for using the tests available in the MONITOR mode.
- Instructions for using the tone generator.

Single Tests for Twisted Pair Cabling

The SINGLE TEST mode on the rotary switch allows individual execution of many of the tests available in the Autotest mode. SINGLE TEST mode features two additional tests: the HDTDTM (High-Definition Time Domain Crosstalk) analyzer and the HDTDRTM (High-Definition Time Domain Reflectometry) test.

Single tests help you isolate cable failures and quickly determine if repairs are good. To certify a cable installation, you should run an Autotest with the appropriate test standard.

Scanning Function

The Single Test versions of the wire map, resistance, HDTDR, and HDTDX analyzer tests include a scanning function, which you can activate by pressing the **3** **Scanning ON** softkey. The scanning function runs the test repeatedly and updates the display each time a test is complete. This function is useful for finding intermittent problems on a cable.

Note

To extend battery life, connect the ac adapter/charger when using the scanning function for more than 1 minute.

When to Use a Remote Unit

A remote unit is required only when testing twisted pair cabling. Table 4-1 shows which cable tests require a remote and which remotes support each test.

If a remote unit is detected at the start of a Single Test, the test tool runs a wire map test before running the selected test. If the wire map test fails, the test tool stops the test and displays the wire map. Press **4** **Continue Test** to run the selected test.

Note

The DSP-4100 and DSP-4300 test tools are compatible only with DSP-4100SR and DSP-4300SR remote units, respectively. The DSP-4100 and DSP-4300 remotes are not compatible with DSP-100, DSP-2000, or DSP-4000 test tools.

Table 4-1. Remote Requirements for Cable Tests



Test	Remote Unit
Autotest	Required.
Wire Map	Required.
NEXT, NEXT@REMOTE	Recommended for NEXT; required for NEXT@REMOTE.
ELFEXT	Required. Test available only in Autotest mode.
Length	Optional. Without a remote, the limit and pass/fail result are not shown.
Impedance	Optional.
Attenuation	Required.
Resistance	Optional. Without a remote, the resistance of cable pairs is reported as “open”, assuming the cable pair is not shorted.
RL, RL@REMOTE	Recommended for RL; required for RL@REMOTE.
ACR, ACR@REMOTE PSACR, PSACR@REMOTE	Required. Tests available only in Autotest mode.
PSNEXT, PSNEXT@REMOTE	Recommended for PSNEXT; required for PSNEXT@REMOTE.
PSELFEXT	Required. Test is available only in Autotest mode.
HDTDR	Optional. Without a remote, the end of the cable is not identified.
HDTDX Analyzer	Recommended. Without a remote, results from tests on short cables may be unreliable.
Impulse Noise	Recommended. Without a remote, test results may not represent the level of noise present on a terminated cable.
Coaxial tests	Never used.
Traffic Monitor	Never used.

Running a Single Test on Twisted Pair Cabling

To run a test as a Single Test, refer to Figure 4-1 and proceed as follows:

Note

For instructions on running the HDTDR test or HDTDX analyzer, see the later sections on those topics in this chapter.

1. Attach the appropriate link interface adapters to the main and remote units. Refer to the table in the Appendix.
2. Turn on the remote unit.
3. Connect the remote to the far end of the cable link. For channel testing, connect using the network equipment patch cord.
4. Turn the rotary switch on the main unit to SINGLE TEST.
5. Connect the test tool to the near end of the cable link. For channel testing, connect using the network equipment patch cord.
6. Use   to highlight the test you want to run.
7. Press  to start the highlighted test.

Note

*If a remote is required for the test, but is not connected, the test tool displays the message **SCANNING FOR SMART REMOTE** and does not run the test until a remote is connected.*

If the calibration message appears, refer to “Calibrating the Test Tool” in Chapter 6 for complete calibration instructions.

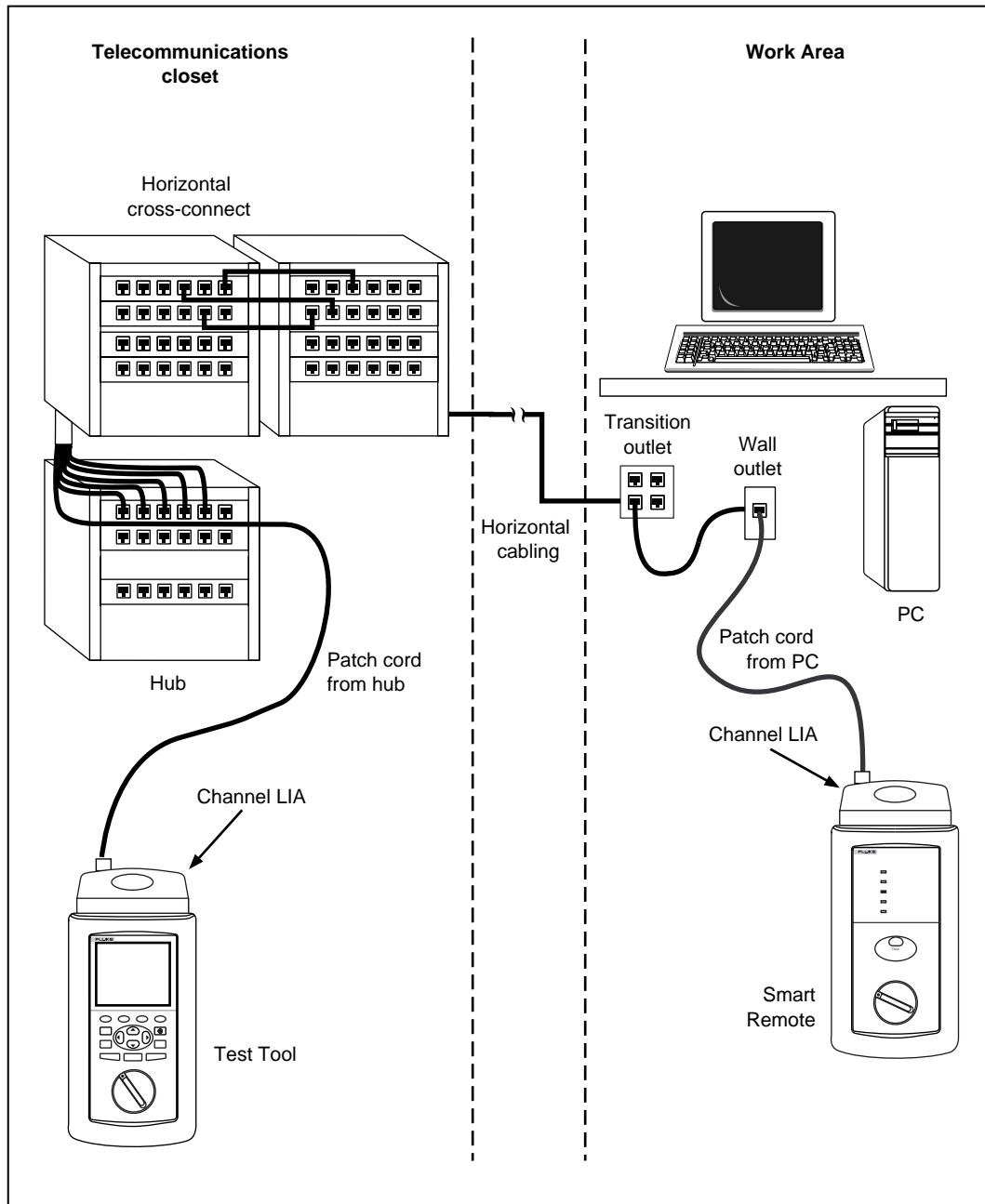

Figure 4-1. Single Test Connections for Twisted Pair Cabling (Channel Connections Shown)

oy08f.eps

The HDTDTMX Analyzer

The HDTDTMX (High-Definition Time Domain Crosstalk) analyzer displays the locations where crosstalk occurs on the cabling under test. The HDTDTMX test uses very short (2 ns) test pulses, which help the test tool resolve smaller crosstalk problems, resulting in more accurate distance-to-fault measurements and better definition of faults on plots. The test is run from both ends of the cabling to help you identify crosstalk sources across the entire link length. You can view the test results in a list or plot format. The list format shows the largest crosstalk value detected on the cabling. The plot shows all of the crosstalk detected.

The crosstalk values displayed are adjusted to compensate for cable attenuation. The values represent the approximate levels of crosstalk as they appear at the sources of the crosstalk. If the crosstalk magnitude is near 50 %, you can expect the NEXT test to fail.

The HDTDTMX analyzer results are not intended for use in determining if cabling meets specifications; the results are intended to help you locate the sources of crosstalk on cabling. To determine if cabling meets specifications for crosstalk, run the NEXT test.

Running the HDTDTMX Analyzer

Note

You can run the HDTDTMX analyzer with or without a remote. If you run the analyzer without a remote, the results will be less reliable.

To run the HDTDTMX analyzer, proceed as follows:

1. Attach twisted pair link interface adapters to the remote and main units.
2. If you are testing with a remote, turn on the remote; then connect the remote to the far end of the cable link.
3. Turn the rotary switch on the main unit to SINGLE TEST.
4. Verify that the test standard and cable type displayed are correct.
5. Connect the test tool to the near end of the cable link.
6. Press **ENTER** to run the HDTDTMX analyzer.

If the test tool does not detect a remote, the following message appears: **NO REMOTE DETECTED.**

HDTD_X Analyzer Results

When the HDTD_X analyzer test is complete, the HDTD_X analyzer results screen appears. Table 4-2 describes the items on the analyzer screen.

Table 4-2. Items on the HDTD_X Analyzer Results Screen

Item	Description
Pairs	The cable pairs relevant to the results.
Peak	The highest magnitude of crosstalk measured on the cable pair. A peak over 50 indicates a crosstalk level that exceeds the limit specified by the selected test standard. Crosstalk levels are adjusted to compensate for cable attenuation.
Distance	The measured distance from the main unit to the peak crosstalk value.
 View Plot	Press to see a plot that shows where crosstalk is detected on the cable.

HDTDX Analyzer Plot

To view a HDTDX analyzer plot for a set of cable pairs, use \downarrow \uparrow to highlight the pairs, then press \odot **View Plot** to see the plot screen for the pairs. Figure 4-2 describes an example of a HDTDX analyzer plot.

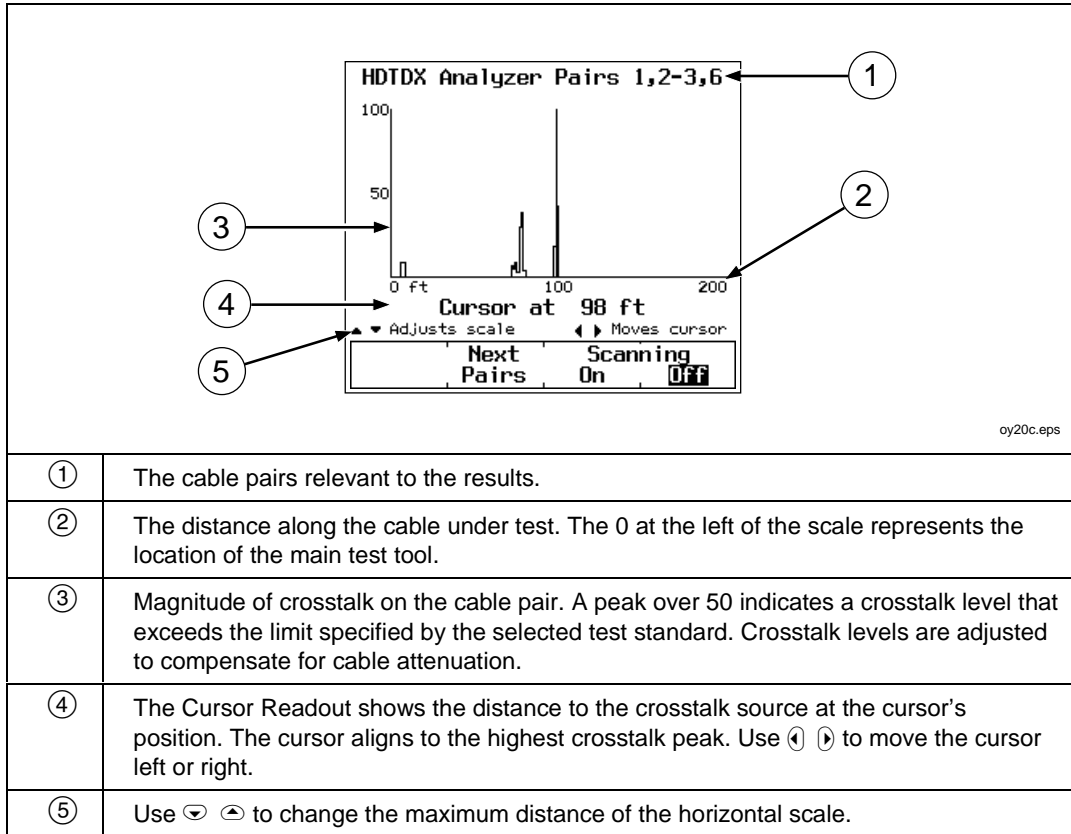

Figure 4-2. Example of an HDTDX Analyzer Plot for a Good Twisted Pair Cable Run

The HDTDR Test

The HDTDR™ (High-Definition Time Domain Reflectometry) test helps you locate sources of return loss on cabling by reporting the locations of signal reflections caused by impedance anomalies. The test is run from both ends of the cabling (if the remote is used) for improved visibility of far-end anomalies.

The test locates anomalies caused by problems such as shorts, opens, poor connections, and mismatches in cable types. You can view the location and size of the anomalies in a list or plot format.

The reflection values displayed are adjusted to compensate for cable attenuation. The values represent the approximate size of the reflections as they appear at the anomalies.

The HDTDR test uses very short (2 ns) test pulses, which help the test tool resolve smaller anomalies, resulting in more accurate distance-to-fault measurements and better definition of faults on plots.

How to Terminate the Cable



You can run the HDTDR test on twisted pair cable with or without a remote unit, and on coaxial cable with or without a terminator. Table 4-3 describes how termination devices affect the results reported for twisted pair and coaxial cable.

Table 4-3. Effects of Termination on HDTDR Results

Cable Type and Termination	Listed Results Show the Following	Plotted Results Show the Following
Twisted pair with no remote	Displays the message No Remote Detected . Results show the two largest reflections greater than or equal to 15%. The largest reflection probably comes from the end of the cable, but is not identified as the end.	All reflections are shown.
Twisted pair with remote	Two largest reflections greater than or equal to 15%. Largest reflection is identified as the end of the cable.	All reflections are shown.
Coaxial cable with no terminator	Two largest reflections greater than or equal to 10%. The largest reflection comes from the end of the cable, but is not identified as the end.	All reflections are shown. The largest reflection comes from the end of the cable.
Coaxial Cable with terminator	No Reflection reported for a good cable. On a faulty cable, the test reports the two largest reflections, but does not identify end of cable.	All reflections are shown. The plot will not show a reflection from the terminated end.



Running the HDTDR Test on Twisted Pair Cabling

To run the HDTDR test on twisted pair cabling, proceed as follows:

1. Disconnect any PCs from the link you are testing.
2. Attach twisted pair link interface adapters to the main and remote units.
3. If you are testing with a remote, turn on the remote; then connect the remote to the far end of the cable link.
4. Turn the rotary switch on the main unit to SINGLE TEST.
5. Verify that the test standard and cable type displayed are correct.
6. Connect the test tool to the near end of the cable link.
7. Use  to highlight **HDTDR**.
8. Press  to run the HDTDR test.

Running the HDTDR Test on Coaxial Cabling

To run the HDTDR test on coaxial cabling, proceed as follows:

1. Turn off any PC nodes connected to the cabling you are testing.
2. If desired, remove the terminator from the far end of the cabling.
3. Attach a channel link interface adapter to the main unit.
4. Turn the rotary switch to SINGLE TEST.
5. Verify that the test standard and cable type displayed are correct.
6. Remove the terminator from the near end of the coaxial cabling; then use the RJ45 to BNC adapter to connect the cable to the test tool.
7. Use  to highlight **HDTDR**.
8. Press  to run the HDTDR test.



HDTDR Results Screen

When the HDTDR test is complete, the HDTDR results screen appears. Table 4-4 describes the items on the screen.

Table 4-4. Items on an HDTDR Results Screen (Twisted Pair Results)

Item	Description
Pair	The cable pair relevant to the results. Not shown for coaxial cable results.
Distance	The first distance is the measured distance from the test tool to the end of the cable. The second distance, if shown, is the distance from the test tool to the beginning of the largest anomaly that caused a reflection greater than the limit defined by the selected test standard.
Peak	The percentage of the test signal reflected at the peak of the anomaly.
② View Plot	Press to see a plot of the locations and reflection percentages of the impedance anomalies detected.

HDTDR Plot Screen

To view the HDTDR plot for a cable pair, use   to highlight one of the pairs; then press **② View Plot** to see the plot screen for that pair. Figure 4-3 describes an example of a HDTDR plot.

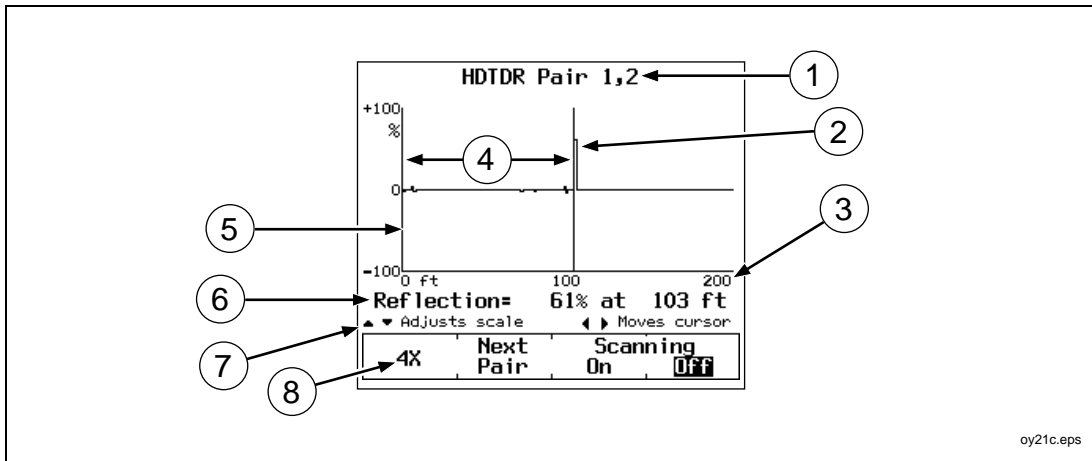

①	The cable pair relevant to the results.
②	The peak value as reported on the results screen.
③	The distance along the cabling under test. The 0 at the left of the scale represents the location of the main test tool.
④	The distance to the end of the cabling as reported on the results screen.
⑤	The percentage of reflected signal relative to the size of the HDTDR test signal. Positive pulses indicate locations on the cabling where the impedance increased. Negative pulses indicate locations on the cabling where the impedance decreased. Bi-polar pulses usually indicate connectors.
⑥	The Cursor Readout shows the location and the reflection percentage at the cursor's position. Use ◀ ▶ to move the cursor left or right.
⑦	Use ⏪ ⏩ to change the maximum distance of the horizontal scale.
⑧	Toggles the vertical scale from 100% (1X) to 25% (4X).

Figure 4-3. Example of an HDTDR Plot (Twisted Pair Results)

Single Test Results for Twisted Pair Cabling

The Single Test results for twisted pair cabling are identical to those displayed by an Autotest, with exceptions noted in the following paragraphs.

Tests not required by the selected test standard produce a **Warning** result when measured values exceed the test's limits.

Wire Map

Wire map results are identical to the Autotest version. See “Wire Map” in Chapter 3 for details. The Single Test version of the wire map test includes the scanning function.

Length

If a remote is connected, the length test and results are identical to the Autotest version. See “Length” in Chapter 3 for details.

If a remote is not connected, the test tool displays the message **NO REMOTE DETECTED**, and the limit and result columns are not shown. If the length of a cable pair cannot be determined, the length value on the display is blank and **WARNING** appears in the result column.

NEXT and NEXT@REMOTE

The NEXT test and results are identical to the Autotest version. See “NEXT” in Chapter 3 for details.

The NEXT@REMOTE test and results are identical to the Autotest version. See “NEXT@REMOTE” in Chapter 3 for details.

ELFEXT

The ELFEXT test and results are identical to the Autotest version. See Chapter 3 for details.

Impedance

The impedance test and results are identical to the Autotest version. See “Impedance” in Chapter 3 for details.

Attenuation (Insertion Loss)

The attenuation test and results are identical to the Autotest version. See “Attenuation” in Chapter 3 for details.

Resistance

If a remote is connected, the results displayed are identical to the display in Autotest. See “Resistance” in Chapter 3 for details.

If a remote is not connected, the test tool displays the message **NO REMOTE DETECTED** and all pair resistances are reported as **OPEN**. A cable pair with a resistance greater than 400 Ω is also reported as **OPEN**.

Return Loss (RL) and RL@REMOTE

The RL test and results are identical to the Autotest version. See “Return Loss” in Chapter 3 for details.

Power Sum NEXT and Power Sum NEXT@REMOTE

The PSNEXT test and results are identical to the Autotest version. See "PSNEXT" in Chapter 3 for details.

Power Sum ELFEXT

The PSELFEXT test and results are identical to the Autotest version described in Chapter 3.

Single Tests for Coaxial Cabling

The Single Test mode on the rotary switch allows individual execution of the coaxial cabling tests available in the Autotest mode. The HDTDR test is also available as a Single Test for coaxial cabling.



The coaxial cable tests available as Single Tests produce results displayed in the same format as displayed in the Autotest mode.

Running a Single Test on Coaxial Cabling

Note

For instructions on running the HDTDR test, see the earlier section “The HDTDR Test.” For instructions on running tests in the MONITOR mode, see the later section “Monitoring Network Activity.”

To run a Single Test on coaxial cabling, refer to Figure 4-4 and proceed as follows:

1. Turn off any PC nodes connected to the cabling you are testing.
2. If you want to measure cable length, remove the terminator from the far end of the cable you are testing.
3. Attach a channel link interface adapter to the main unit.
4. Turn the rotary switch to SINGLE TEST.
5. Verify that the test standard and cable type are correct. You can change these settings in the SETUP mode.
6. Remove the terminator from the near end of the coaxial cabling; then use the RJ45 to BNC adapter to connect the cable to the test tool.
7. Use   to highlight the test you want to run.
8. Press  to start the highlighted test.

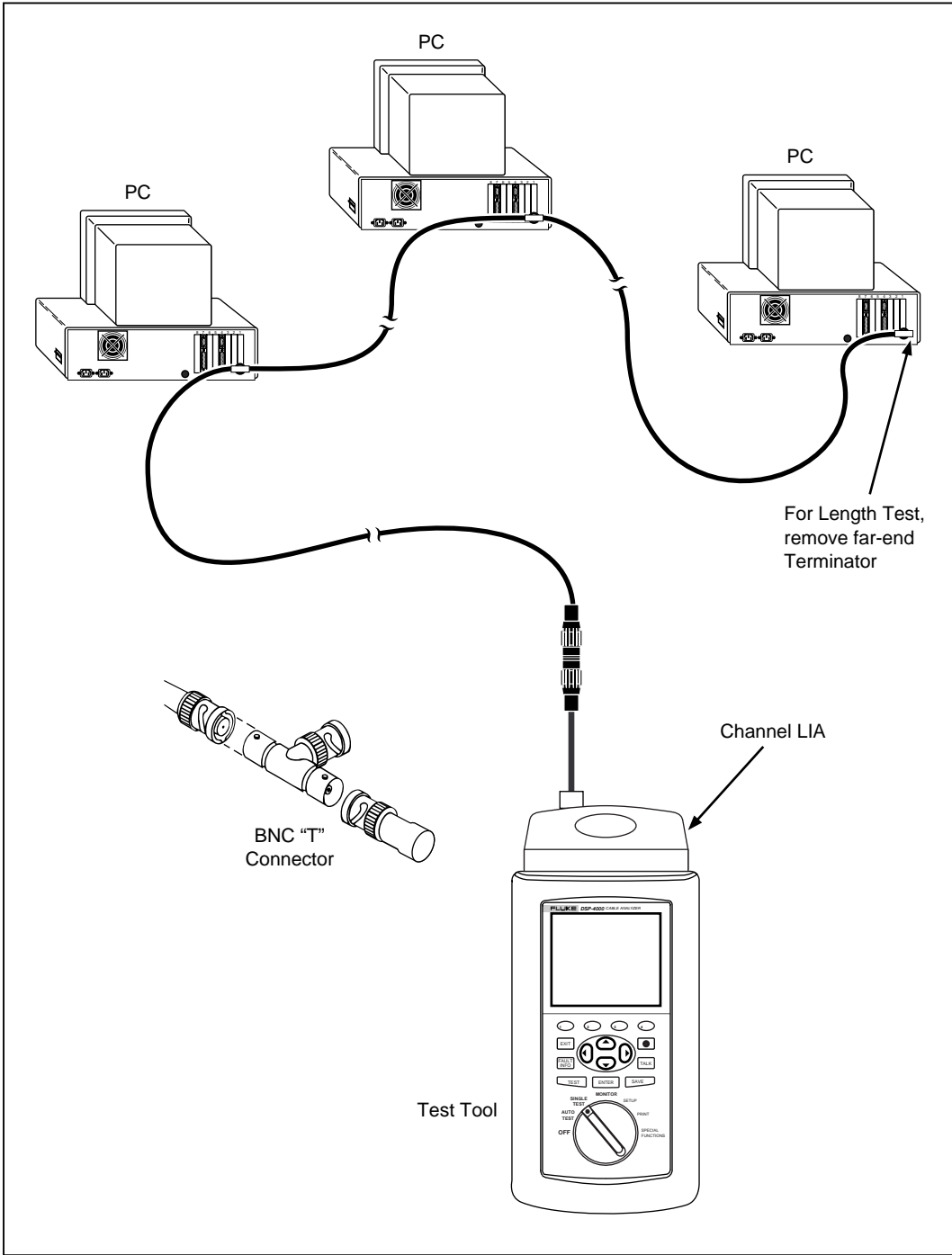

Figure 4-4. Single Test Connections for Coaxial Cabling

oy22f.eps

Single Test Results for Coaxial Cabling

The Single Test results for coaxial cabling are identical to those displayed by an Autotest, with exceptions noted as follows.

Impedance

Identical to Autotest version. See “Impedance” in Chapter 3 for details.

Resistance

Identical to Autotest version. See “Resistance” in Chapter 3 for details. The Single Test version of the resistance test includes the scanning function.

Length

Identical to Autotest version. See “Length” in Chapter 3 for details.

HDTDR for Coaxial Cabling

The HDTDR test is described for both twisted pair and coaxial cabling in the earlier section “The HDTDR Test.”

Monitoring Network Activity

Note

Monitoring network activity requires the DSP-LIA013 adapter.

The MONITOR mode on the rotary switch lets you monitor Ethernet traffic for collisions, jabber, peak traffic, and percentage of network utilization. You can monitor traffic on 10BASE-T or 100BASE-TX twisted pair cabling.

This feature lets you identify active cabling and provides some information on network activity. If you want to troubleshoot active networks, contact your Fluke Networks representative for information on LAN diagnostic tools.

When connected to a network, the test tool automatically generates link pulses to activate the hub. The test tool uses Auto-Negotiation when attempting to link to monitor 10/100BASE-TX traffic. If a link state does not occur, the test tool displays the warning message **NO LINK PULSE**.

To monitor network traffic on a twisted pair Ethernet network, refer to Figure 4-5 and proceed as follows:

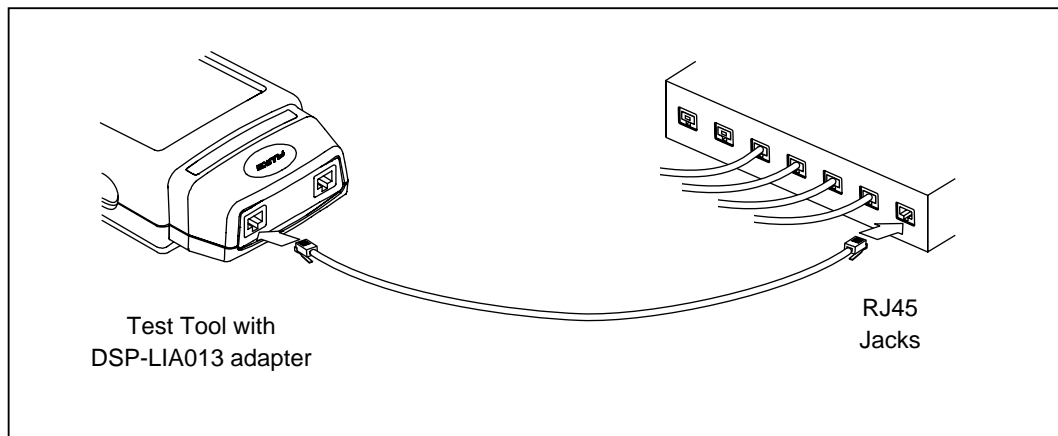





Figure 4-5. Connections for Monitoring Network Traffic

oy23f.eps

Notes

To extend battery life, use the ac adapter/charger when monitoring network traffic for extended periods. While monitoring network traffic, the test tool's automatic power-down function is disabled.

The Monitor jack does not support the Talk mode.

1. Attach a traffic link interface adapter (such as the DSP-LIA013) to the test tool.
2. Turn the rotary switch to MONITOR.
3. Use  to highlight **10/100BASE-TX Traffic**.
4. Remove any cable connected to the test tool's unused test connector.
5. Use a patch cable of the correct impedance to connect the test tool to the network as shown in Figure 4-5. Connect to the jack indicated by the arrow at the top of the display.
6. Press  to start the traffic test.
7. Use the  **10T Only** or  **100TX Only** softkey to select traffic monitoring at 10 Mb/s or 100 Mb/s.

If you don't know which speed to use, and the test tool is not already trying to link using Auto-Negotiation, press  until the display reads **Auto-Negotiation**. This lets the test tool select the proper speed to match the hub.

As the traffic test runs, the results shown on the test tool's display are updated every second. Table 4-5 describes the items on the screen.

Table 4-5. Items on the Traffic Monitor Screen

Item	Description
Utilization Last 1 second	Percentage of the network's transmission bandwidth used over the last 1 second. Utilization includes correct frames, collisions, and jabber. The percentage indicates the current traffic density.
Utilization Average	The average of all the 1-second utilization percentages since the start of the test.
Utilization Peak	The highest 1-second utilization percentage recorded since the start of the test.
Collisions Last 1 second	The percentage of collision frames as compared to the total number of frames detected in the last 1 second. Collisions are counted when runt packets are detected.
Collisions Average	The average of all the 1-second collision percentages since the start of the test.
Collisions Peak	The highest 1-second collision percentage recorded since the start of the test.
Bottom of screen	If jabber is detected, the message Jabber Detected appears in this space. A jabber is reported if a frame is detected to be larger than the maximum legal size. If no link pulse is detected, the message NO LINK PULSE appears in this space.
① Sound On ② Sound Off	Activates and deactivates a sound that represents network activity.
④ Stop Test	Stops the traffic test and freezes the screen. To restart the traffic test, press <input type="button" value="TEST"/> .

Identifying Hub Port Connections

The hub port locator helps you determine which port a cable is connected to at a hub. The locator sends a link pulse to the hub, causing the port's LED to blink.

To identify a hub port connection, proceed as follows:

1. Attach a traffic link interface adapter (such the DSP-LIA013) to the test tool.
2. Turn the rotary switch to MONITOR.
3. Use  to highlight the hub port locator selection; then press **ENTER**.
4. Use a patch cable of the correct impedance to connect the test tool to the network as directed on the display.
5. Locate the connected port by finding the flashing LED on the hub's LED panel.

Monitoring Impulse Noise

The Monitor Impulse Noise function allows you to monitor electrical noise on inactive twisted pair cabling. Pair 3, 6 is monitored.

The noise test takes noise voltage samples every second. Voltages that exceed the impulse noise threshold are regarded as noise "hits." If the 10BASE-T standard is selected, the noise test results include a pass or fail indication. A fail result is displayed if more than two noise hits are detected in a 10-second interval.

Changing the Impulse Noise Threshold

You can set the impulse noise threshold to a value from 10 mV to 500 mV in increments of 10 mV. The default noise threshold value is 270 mV.

To change the noise threshold, proceed as follows:

1. Turn the rotary switch to **SETUP**.
2. Use **4** **Page Down** and **▼** to find and highlight the impulse noise threshold setting.
3. Press **1** **Choice**.
4. Use **3** **DEC** or **4** **INC** to change the threshold.
5. Press **ENTER** to store the threshold setting.

Running the Impulse Noise Test

The impulse noise test is not valid for coaxial cabling because the level of noise on coaxial cabling is negligible.

To monitor impulse noise, refer to Figure 4-6 and proceed as follows:

Note

To extend battery life, use the ac adapter/charger when monitoring impulse noise for extended periods. While monitoring impulse noise, the test tool's automatic power-down function is disabled.

Note

Monitoring impulse noise without a remote connected may produce unreliable test results.

1. Attach twisted pair link interface adapters to the remote and main units.
2. Turn on the main and remote units. Make the connections shown in Figure 4-6.
3. Turn the rotary switch on the main unit to **MONITOR**.
4. Use **▼** to highlight **Impulse Noise**; then press **TEST** .

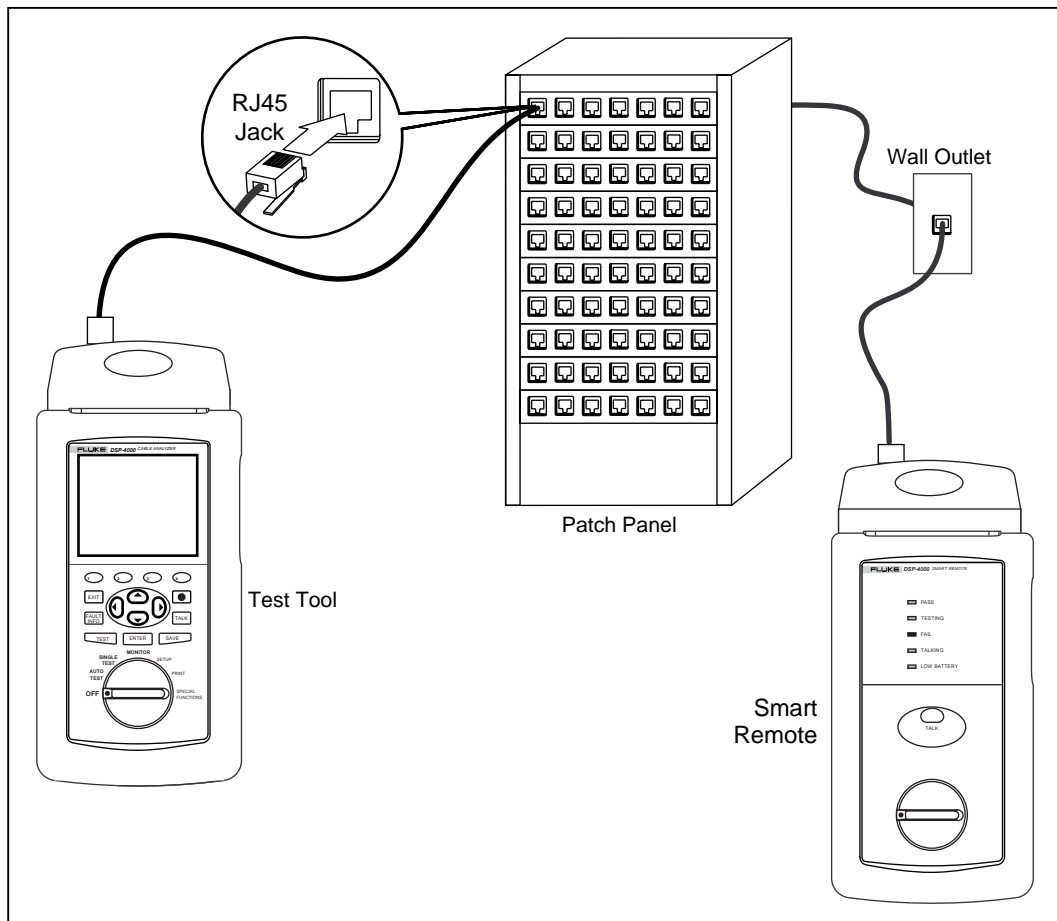

oy24f.eps

Figure 4-6. Typical Connections for Monitoring Impulse Noise

Noise Test Results

As the noise test runs, the displayed test results are updated every second after the first 10-second sample period. Table 4-6 describes the items on the screen.

Table 4-6. Items on the Noise Monitor Screen



Item	Description
Impulse Noise Threshold	The minimum level of noise that is considered to be a noise hit. The default threshold is 270 mV. If you want to change the fault threshold, see the earlier section "Changing the Impulse Noise Threshold."
Noise Test	The overall result of the noise test. Displayed only when 10BASE-T is selected. A PASS result means that no 10-second intervals included more than two noise hits. A FAIL result means that more than two noise hits were detected during a 10-second interval.
Average	The average number of noise hits per second since the start of the test.
Peak	The highest number of noise hits per second and the time at which the peak was recorded.
④ Stop Test	Stops the noise test and freezes the screen. To restart the noise test, press <input type="button" value="TEST"/> .

Determining Hub Port Capabilities

This test determines if a hub supports the following standards:

- Auto-Negotiation
- 10BASE-T
- 100BASE-TX
- 100BASE-T4
- 100BASE-TX Full Duplex
- 10BASE-T Full Duplex



To determine hub port capabilities, proceed as follows:

1. Attach a traffic link interface adapter (such the optional DSP-LIA013) to the test tool.
2. Use a patch cable of the correct impedance to connect the network connection to the test tool's Monitor jack.
3. Turn the rotary switch to MONITOR.
4. Use  to highlight **HUB Port Capabilities**; then press .

Using the Tone Generator

If you have an inductive pickup device, such as a Fluke Networks 140 A-Bug Tone Probe, you can use the test tool's tone generator to identify twisted pair and coaxial cable runs and connections. The tone generator produces a signal on the cabling under test. You can hear the signal as an audible tone when you place an inductive pickup device near the cabling or one of the cabling's connectors.

To use the tone generator, proceed as follows:

1. Attach a twisted pair link interface adapter to the test tool.
2. Turn the rotary switch to SPECIAL FUNCTIONS.
3. Connect the test tool to the cable.
4. Use  to highlight **Tone Generator**; then press .
5. Use an inductive pickup device along the cable run or at far end connectors to determine which cable is connected to the test tool.

Chapter 5

Viewing and Printing Saved Reports

Chapter 5 provides the following information:

- Instructions for viewing, deleting, and renaming test reports saved in the test tool's memory.
- Instructions for sending saved test reports to a serial printer.

Viewing, Renaming, and Deleting Test Reports

To view test reports, delete test reports, or rename the cable identification given on a saved report, proceed as follows:

1. Turn the rotary switch to SPECIAL FUNCTIONS.
2. Press **ENTER** to select **View/Delete Test Reports**. The VIEW/DELETE TEST REPORTS screen appears showing the first screen of test report labels. The reports are listed in the order saved, starting with the oldest report in memory. Each test report label shows the date and time the report was saved, the cable identification name, and an overall test result (pass, fail, or warning).
3. Use **3** **Page Up**, **4** **Page Down**, and **▼ ▲** to highlight the report you want to view, rename, or delete.
4. Press the softkey labeled with the function you want. The softkeys function as follows:
 - **1 Delete Report**: Deletes the highlighted report from memory.
 - **2 View Result**: Displays the overall Autotest result and headroom value for the highlighted report. To see detailed results for a test, press **View Result** again; then highlight the desired test and press **ENTER**.

Note for Models DSP-4100/4300

You cannot view results saved on a memory card if they were created using a different test standards version than is present in the test tool. To view these results, use LinkWare™ software to upload them to a PC.

To change the cable identification, press the **2** **Rename Report** softkey that appears after you press **View Result** twice. Use the softkeys to edit the cable identification. Press **SAVE** when you are done.

To delete all of the Autotest reports stored in memory, select **Delete All Test Reports** from the main SPECIAL FUNCTIONS menu.

Note for Model DSP-4300

When a memory card is present, the VIEW/DELETE TEST REPORTS function always shows the reports saved on the card.

When a card is not present, the test tool shows the reports saved in internal memory.

Printing Test Reports









This section describes how to send reports directly to a printer. If you want to send reports to a computer, use the LinkWare™ software provided with the test tool. See “Getting Started” under Help on the LinkWare toolbar for details.

The PRINT mode on the rotary switch lets you send saved Autotest reports or report summaries to a serial printer or a PC through the test tool’s EIA-232C serial port. You can also edit the header, operator name, and site name that appear at the top of reports.

Configuring the Serial Port

Before you send a report to a printer, set the test tool's serial port settings to match the printer's serial port settings. The serial port settings include baud rate, flow control, and printer type. For the type of printer, you can select Hewlett-Packard, Epson, or Text Only. The Text Only setting, which omits formatting commands for the printer, is suitable for sending Autotest reports to a terminal emulator or to a printer other than a Hewlett-Packard or Epson.

To configure the test tool's serial port, proceed as follows:

1. Turn the rotary switch to PRINT.
2. Use   to highlight **Edit Print Parameters**. Press .
3. Use   to highlight the parameter you want to change.
4. Press  **Choice**.
5. Use   to highlight the setting you want.
6. Press  to select the highlighted setting.
7. Repeat steps 3 through 6 to change additional serial port settings.

Note

You can also configure the serial port in the SETUP mode.

Printer Interface Cable

The interface cable provided with the test tool is configured for serial communication with a PC. To communicate with a serial printer, you will probably need a different cable or an adapter for the cable provided. The pin configuration for the cable provided and for Fluke's 9-to 25-pin adapter is given in "Specifications" in Chapter 8. Refer to your printer's manual for specifications on your printer's serial port.

Printing

To send a report through the test tool's serial port directly to a serial printer, refer to Figure 5-1 and proceed as follows:

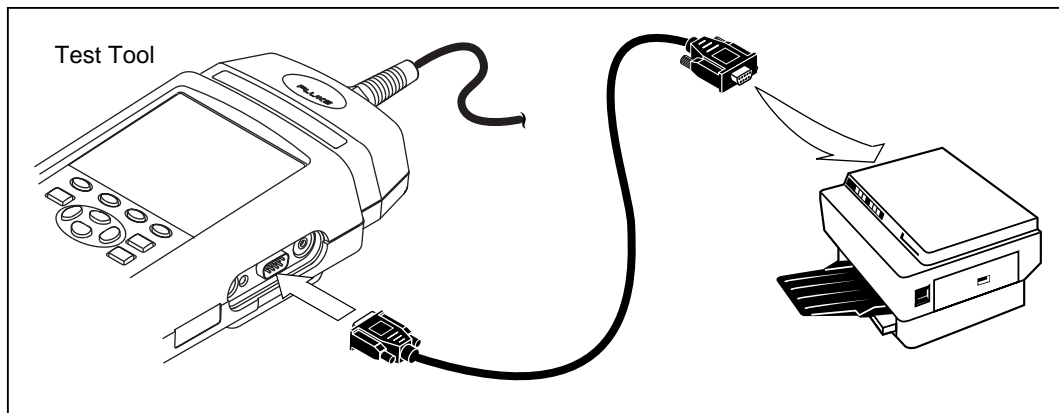

oy25f.eps

Figure 5-1. Connections for Printing Test Reports

1. Remove any cables connected to the connectors at the top of the test tool.
2. Configure the test tool's serial port, as described in the previous section.
3. Use an appropriate cable to connect the test tool to the printer.
4. Turn the rotary switch to PRINT.
5. Use to highlight the print function you want.
6. Press to select the highlighted function.

The results of selecting each function are as follows:

- **All Autotest Reports:** Prints all of the reports stored in the test tool's memory. Before printing, the test tool's report format, baud rate, printer type, and flow control are displayed. You can change these settings in the PRINT mode, as described in the earlier section "Configuring the Serial Port."

Press to start printing. To stop printing and return to the main print screen, press .

- **Selected Autotest Reports:** Displays the SELECT AUTOTEST REPORTS screen where you can select the reports you want to print, as follows:
 1. Use **3** Page Up, **4** Page Down, and **▼** **▲** to highlight a report label.
 2. Press **ENTER** to select the highlighted report. An asterisk appears on the label to show that the report is selected for printing. To select several consecutive reports, hold down **ENTER**. To remove an asterisk, highlight the report label; then press **ENTER**.
 3. To print the selected reports, press **1** Start Print; then press **ENTER**. To stop printing and return to the main Print menu, press **EXIT**.
- **All Report Summary:** Same as All Autotest Reports, except that reports are printed in summary form. The summaries give the date and time each report was saved, the cable identification entered for each report, and an overall test result for each report.
- **Selected Report Summary:** Same as Selected Autotest Reports, except that reports are printed in summary form.
- **Edit Report Identification:** Displays the REPORT IDENTIFICATION screen, where you can edit the Custom Header, Operator Name, or Site Name that appear on printed Autotest reports. This function also appears in the SETUP mode. See "Editing the Report Identification" in Chapter 2 for complete instructions.

To edit the cable identification assigned to a saved report, see "Viewing, Renaming, and Deleting Test Reports" at the end of this chapter.
- **Edit Print Parameters:** Lets you change the Autotest report format and configure the serial port.

When printing is complete, the test tool displays the following message: **Delete All Printed Reports?**. To delete the printed reports from memory, press **3** Yes twice. To exit without deleting the printed reports, press **4** No or **EXIT**.

If the Printer Does Not Respond

If the printer does not respond correctly to the test tool, the message **Serial Port Error** appears. In this case, check the following:

Verify that the printer is online.

- Verify that the baud rate and flow control settings are the same for the test tool and the printer.
- Verify that the printer type in SETUP matches the type of printer connected to the test tool.
- Verify that the interface cable is securely connected to the printer and the test tool.
- Verify that the cable or adapter you are using is compatible with your printer. Pin assignments for the test tool's serial port are given in "Specifications" in Chapter 8. Refer to your printer's manual for specifications for your printer's serial port.

Viewing and Printing Reports from a PC

LinkWare Cable Test Management software lets you upload records to a PC, edit and organize them, and produce professional-quality cable test reports. See the online help or "Getting Started" under Help on the LinkWare menu for details. LinkWare software is included with the tester. You may also download LinkWare software from the Fluke Networks website.

Chapter 6

Calibrations and Custom Test Standards

Chapter 6 provides the following information:

- Instructions for calibrating the test tool.
- Instructions for determining a cable's NVP value.
- Instructions for defining a custom test standard.

Calibrating the Test Tool

Before shipment, each test tool is calibrated to work with the remote unit shipped in the same package. If you want to use your test tool with a different remote, you must perform a self-calibration to store the new calibration parameters in the test tool. The test tool stores the calibration data in non-volatile memory that is maintained by a lithium battery. You can calibrate your test tool to work with two different remotes. Self-calibration is not required when you switch between link interface adapters.

To ensure maximum accuracy of test results, perform the self-calibration every 30 days. Fluke Networks recommends factory calibration once a year to ensure that the test tool meets or exceeds the published accuracy specifications. To return a unit to Fluke Networks for calibration, call an authorized Fluke Networks Service Center for return instructions.

Notes

All DSP-4000 Series test tools use the DSP-4000 calibration module.

Allow a 1 minute warm-up time before performing a self-calibration. Perform the self-calibration only after the test tool has warmed up to an ambient temperature between 10° C and 40° C (50° F and 104° F).

To recalibrate the test tool, refer to Figure 6-1 and proceed as follows:

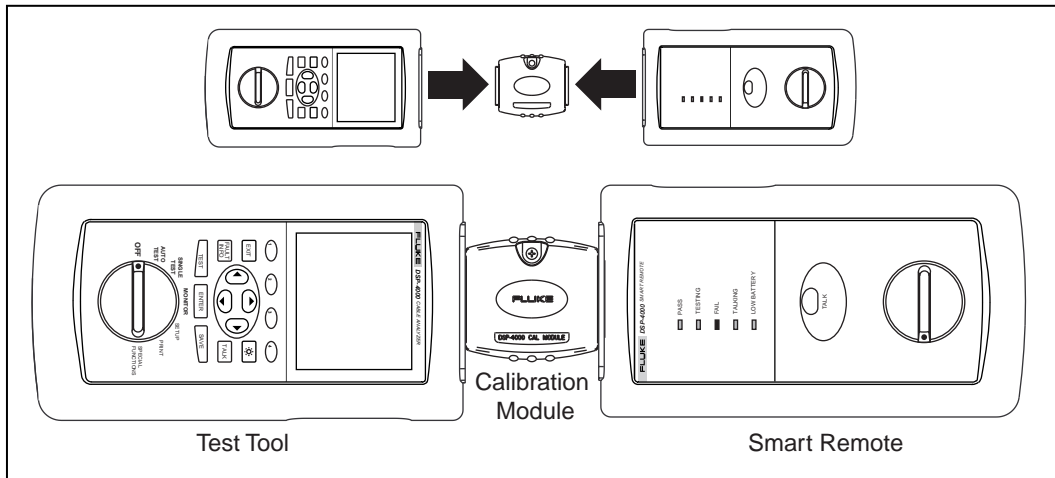

oy77f.eps

Figure 6-1. Connections for Self-Calibration

1. Turn the rotary switch to **SPECIAL FUNCTIONS**.
2. Use **▼** to highlight **Self Calibration**.
3. Press **ENTER**.
4. Connect the test tool to the remote as directed by the displayed messages.
5. Press **TEST** to start the calibration.

When the calibration is complete, the calibration data and the remote's serial number are automatically stored in the test tool's calibration library.

If the message **SELF CALIBRATION FAIL** appears, check the following:

- Verify that the test tool and remote are securely connected with the calibration module.
- Verify that the connected units are resting on a flat surface.
- Check the main unit, remote unit, and the calibration module for damaged connectors.

If the self calibration continues to fail, send the main and remote units and the cable adapters to the nearest Fluke Networks service center. See "Service Center Repair" in Chapter 8 for details.

Calibrating the Permanent Link Adapters

The optional DSP-PLCAL automated calibration kit lets you calibrate your permanent link adapters to meet enhanced accuracy specifications. Calibration compensates for physical changes that occur over time to the adapter's cable and other components. Regular calibration helps eliminate false fail results and helps ensure that test results represent the link's actual performance.

Fluke Networks recommends that you use the DSP-PLCAL kit to calibrate your adapters after the first 40 hours of use. Thereafter, calibrate the adapters at least every 6 months.

Contact Fluke Networks for more information on the DSP-PLCAL kit.

NVP Calibration





The Determine Cable NVP function allows you to determine the NVP (nominal velocity of propagation) for a known length of cable and save the value for additional measurements of unknown lengths of the same type of cable. The calibrated NVP value applies only to the selected test standard. You can also enter a known NVP value or use the **Set to Default** softkey to set the NVP to the default value, which is the NVP for a typical sample of the selected cable type.

To determine a cable's NVP value, proceed as follows:

Notes

To determine a cable's NVP, you should use a cable at least 15 m (50 ft) long. The recommended length is 30 m (100 ft).

NVP is determined for the cable pair with the shortest electrical delay.

1. Attach a channel link interface interface adapter to the main unit.
2. Turn the rotary switch to SPECIAL FUNCTIONS.
3. Use  to highlight **Determine Cable NVP**.
4. Press .
5. As prompted by the display, connect a known length of the appropriate cable to the test tool. Use the RJ45 to BNC adapter, if necessary.
6. Verify that no cables are connected to the DB9 connector on the test tool.
7. Press .
8. Use  or  to change the displayed length to the known length of the attached cable. As you adjust the length measurement, the NVP value changes automatically. The range for NVP values is 50.0 % to 99.9 %.

9. When the displayed length matches the known length of the cable, press **SAVE** to store the new NVP value and return to the main Special Functions menu. To exit the screen without saving the new NVP value, press **EXIT**.

If the message **CABLE FAULT DETECTED** appears, verify that the selected cable type is correct, check the cable for proper pin connections, or calibrate with a different cable.

Configuring a Custom Test

The Configure Custom Test function allows you to define custom standards for up to four custom tests. The following parameters and tests are available (tests available depend on the default standard you select):

- Custom test name (a name you enter for the configuration)
- Default test standard
- Cable name (a name you enter for the cable type)
- NVP (Nominal Velocity of Propagation)
- Maximum cable length
- Fault threshold for impedance anomalies
- Wire map assignments for cable pairs
- Resistance test enabled or disabled
- Impedance test enabled or disabled
- Attenuation test enabled or disabled
- NEXT and NEXT@REMOTE tests enabled or disabled
- ELFEXT test enabled or disabled
- RL test enabled or disabled
- ACR and ACR@REMOTE tests enabled or disabled
- PSNEXT and PSNEXT@REMOTE tests enabled or disabled
- PSELFEXT test enabled or disabled
- PSACR and PSACR@REMOTE tests enabled or disabled

Note

To determine the NVP for a custom test configuration refer to the previous section, “NVP Calibration.”

During the configuration process, you can abandon the changes you have made by pressing **1** **Abort**.

To reset a parameter back to the default value, highlight the parameter; then press **2** **Set to Default**.

To reset all of the parameters back to default values, highlight the test standard on Page 1 of the configuration screens; then press **ENTER**. Use **▲ ▼** to select the desired default standard; then press **ENTER**.

To configure a custom test, proceed as follows:

1. Turn the rotary switch to SETUP.
2. Press **4** **Page Down** until you see the CONFIGURE CUSTOM TEST selection.
3. Highlight a custom test name. The default cable names are *** Custom Cable 1*** through *** Custom Cable 8 ***. An asterisk always precedes and follows the name of a custom test configuration. Press **ENTER**.
4. Use **▲ ▼** to select a parameter to change. Use **4** **Page Down** to see additional parameters. Press **ENTER** to select a highlighted parameter for editing.

Note

Selecting a default standard for a previously configured custom test resets all test parameters to default values.

5. Use the appropriate keys to select the value you want; then press **ENTER**.

If you selected to change the custom test name or the cable type, the alphanumeric entry screen appears. Use the appropriate keys to enter a name up to 27 characters long. When you are finished entering characters, press **SAVE**.

6. Repeat steps 4 and 5 to change additional parameters.
7. When you are finished configuring test parameters, press **SAVE** to store the custom configuration.

Chapter 7

Basic Cabling Testing

Chapter 7 provides the following information:

- A description of LAN cable construction
- A description of channel, basic link, and permanent link configurations
- Explanations of LAN cable tests
- Explanations of the HDTDX™ and HDTDR™ analyzer tests and plots
- Basic troubleshooting procedures for LAN cable.

LAN Cable Construction

LAN cables have a number of characteristics in common with other types of electrical cables. All electrical cables have continuity, which means that they serve as a complete path for electrical current flow. Each end of a cable has some type of connector for connecting the cable to the appropriate electrical device. Cables with multiple wires usually have a pin assignment that describes how the wires are arranged in the connectors.

Cables are designed to perform best in specific applications. For example, power cables are designed to minimize power losses at frequencies of 50 Hz or 60 Hz. LAN cables are designed to minimize signal distortion at higher frequencies.

Two types of cables are designed for use with LAN systems: twisted pair cable and coaxial cable.

Twisted Pair Cable

Twisted pair cable consists of wire pairs that are twisted together, as shown in Figure 7-1. The wires are twisted to minimize crosstalk between the cable pairs.

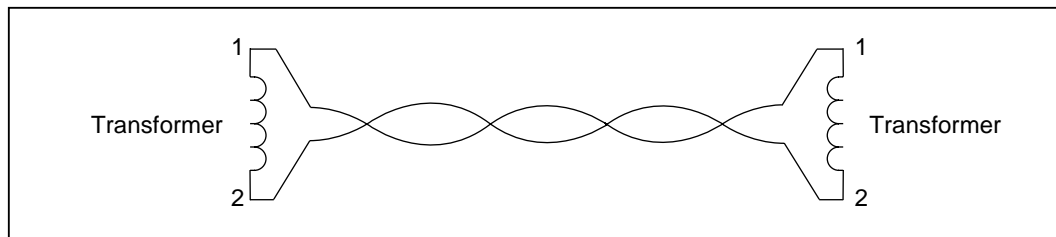

oy27f.eps

Figure 7-1. Twisted Pair Cable Construction

Each cable pair forms a complete electrical path for signal transmission. The currents flowing through the wires in each pair are equal, but flow in opposite directions. These currents produce electromagnetic fields that could transmit electrical noise to nearby wires. However, the fields surrounding the two wires have opposite polarities. Twisting the wires together causes the fields to cancel out, which minimizes the electrical noise, or crosstalk, generated by each cable pair.

There are two types of twisted pair cable: shielded twisted pair (STP) and unshielded twisted pair (UTP). STP cable, which may also be referred to as ScTP (screened twisted pair) or FTP (foil-screened twisted pair), contains a conductive shield that is electrically grounded to protect the wires inside from electrical noise. STP cable is more expensive and more difficult to install than UTP.

Figure 7-2 shows the pin connections and wire colors for correct wiring to TIA 568A and 568B standards.

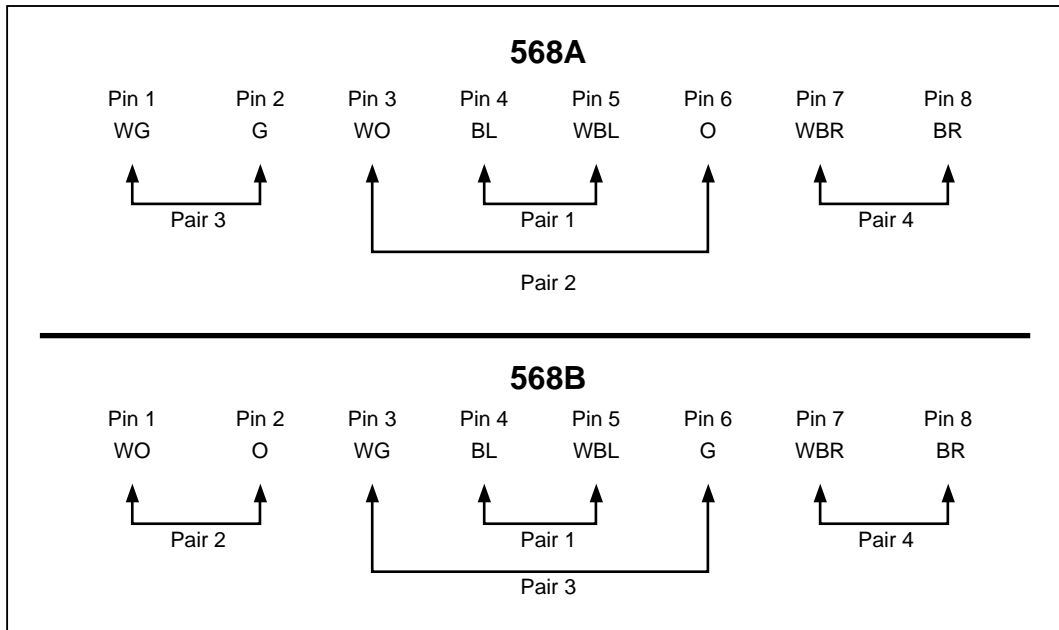

oy28f.eps

Figure 7-2. EIA/TIA RJ45 Connections

The 568A and 568B wiring standards have the same electrical performance; however, the two standards should not be mixed in the same network because of the risk of wiring errors.

Coaxial Cable

Coaxial cable consists of a conductor surrounded first by an insulating material, then by a braided conductive sheath, as shown in Figure 7-3. In LAN applications, the sheath is electrically grounded and serves as a shield that protects the inner conductor from electrical noise. The shield also helps eliminate signal loss by keeping the transmitted signal confined to cable.

Coaxial cable can carry a wider range of frequencies and can be used in greater lengths than twisted pair cable. However, coaxial cable is more expensive than twisted pair.

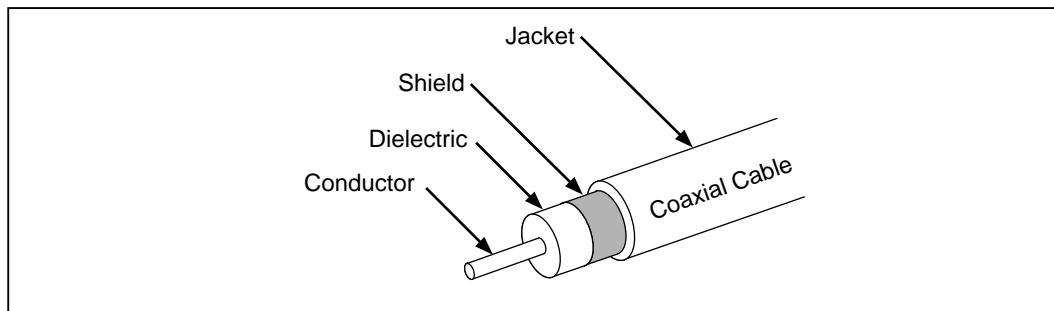

oy29f.eps

Figure 7-3. Coaxial Cable Construction

Basic Link Connections

The cable links you test may or may not include equipment patch cables and extra transition connections in the telecommunications closet and work area. For example, cable installers are often responsible only for the permanent cabling installed between the closet and the first wall outlet in the work area. This segment of cabling was originally defined in TSB-67 as the basic link, shown in Figure 7-4. The basic link consists of up to 90 m of horizontal cable, one transition connector at each end, and two test equipment patch cables of no more than 2 m each.

Basic link testing, which is no longer recognized in TIA and ISO standards, is becoming less common as cabling installers adopt the newer permanent link testing standard.

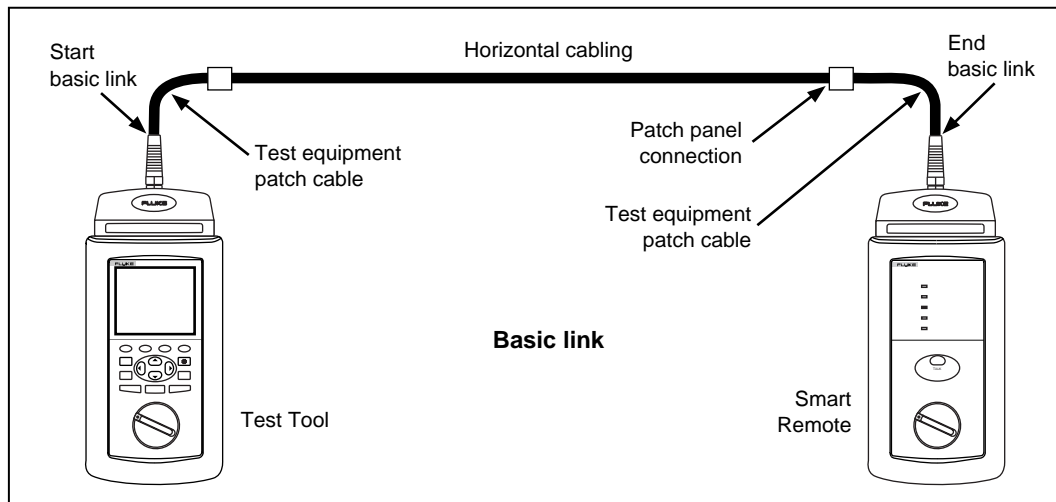

Figure 7-4. Basic Link Test Connections

oy73f.eps

Channel Connections

A channel includes the transition connectors and equipment patch cables added to a basic link segment. The channel should be tested from end to end to verify the performance of all the components. In this case, you use the equipment patch cables to connect your test tool to the channel, as shown in Figure 7-5. TSB-67 defines the channel as a basic link plus one extra transition connector at each end and up to 10 meters of equipment patch cables. Because of the extra connectors and patch cables, the test limits for a channel are looser than those for the basic link.

A channel with just one connector at each end resembles a basic link; however, you would use a channel test standard if you are using the network equipment's patch cables to connect to your test tool.

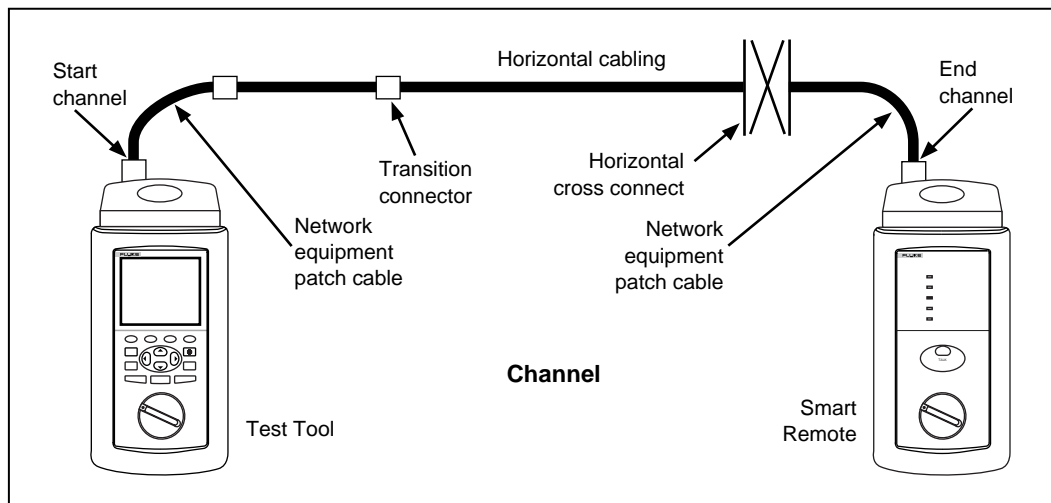

oy69f.eps

Figure 7-5. Channel Test Connections

Permanent Link Connections

Permanent link test connections are similar to basic link connections, except that the effects of the test equipment's patch cables are excluded from the test results. When compared to the basic link and channel, this test configuration provides the most accurate characterization of the permanently installed section of the cabling. The permanent link configuration also helps eliminate false FAIL results caused by test equipment patch cables. Figure 7-6 illustrates permanent link test connections.

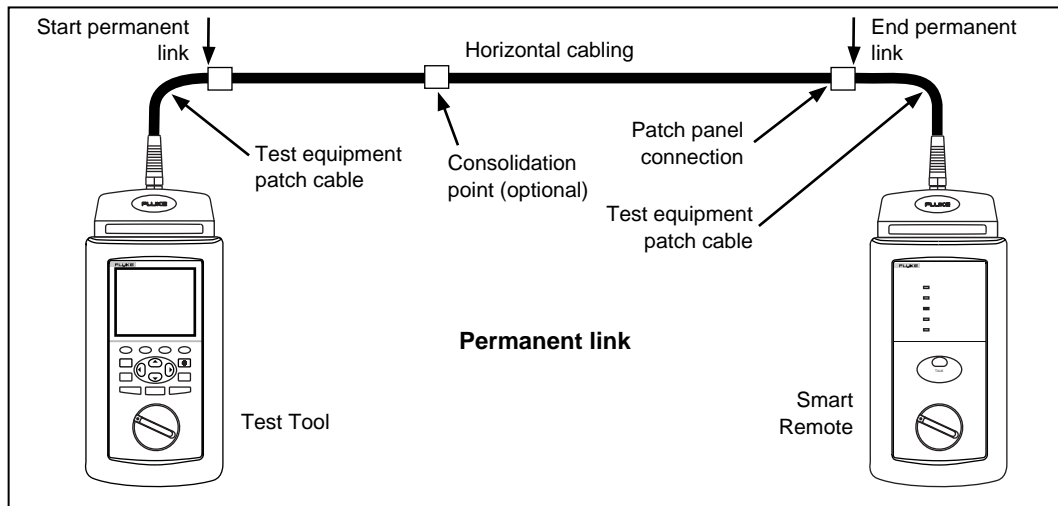
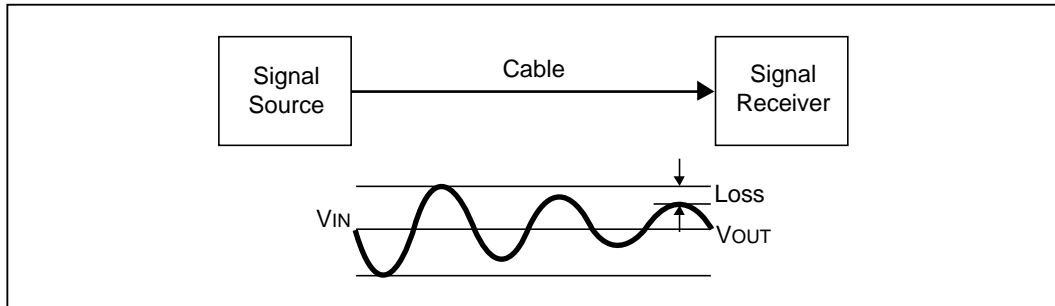

Figure 7-6. Permanent Link Test Connections

oy87f.eps

Attenuation (Insertion Loss)

Attenuation is a decrease in signal strength over the length of a cable, as shown in Figure 7-7.



oy30f.eps

Figure 7-7. Attenuation of a Signal

Attenuation is caused by a loss of electrical energy in the resistance of the cable wire and by leakage of energy through the cable's insulating material. This loss of energy is expressed in decibels. Lower attenuation values correspond to better cable performance. For example, when comparing the performance of two cables at a particular frequency, a cable with an attenuation of 10 dB performs better than a cable with an attenuation of 20 dB.

Cable attenuation is determined by the cable's construction, length, and the frequencies of the signals sent through the cable. At higher frequencies, the skin effect and the cable's inductance and capacitance cause attenuation to increase.

Noise

Electrical noise is unwanted electrical signals that alter the shape of the signals transmitted on a LAN cabling. Figure 7-8 shows an example of how noise affects the shape of an electrical signal known as a sine wave. Signals that are severely distorted by noise can cause communication errors in a LAN.

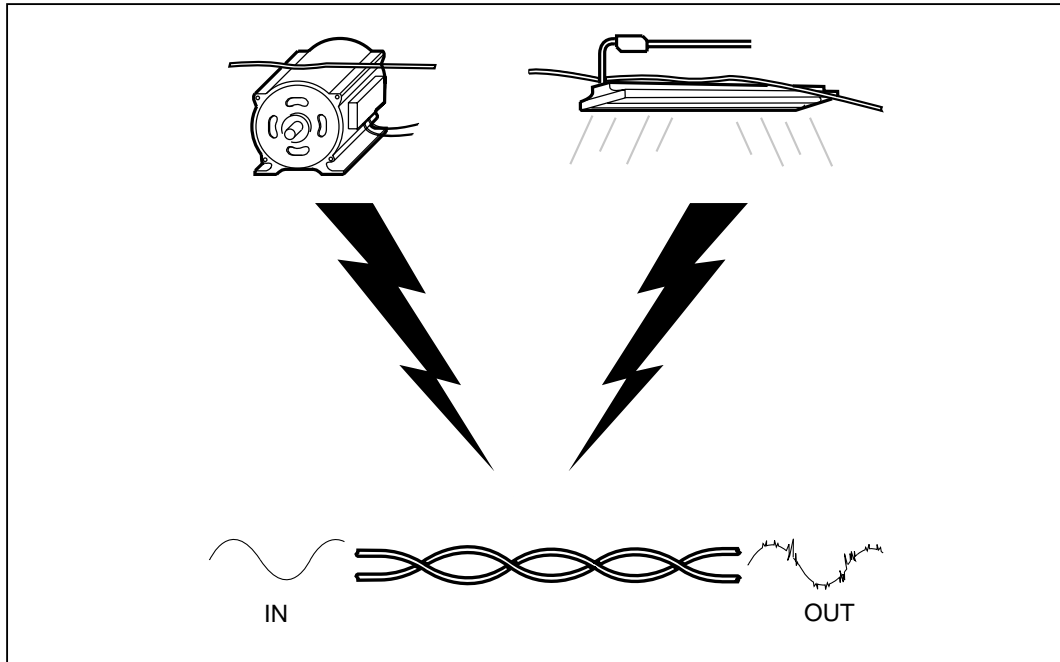

oy31f.eps

Figure 7-8. Sources of Electrical Noise

Electrical noise is generated by any device that uses or generates voltages that vary over time. Varying voltage generates a varying electromagnetic field, which transmits noise to nearby devices in the same way that a radio transmitter transmits signals to your radio. For example, fluorescent lights, which use 50 Hz or 60 Hz ac (alternating current) power, continuously radiate a 50 Hz or 60 Hz signal that can be received by nearby devices as electrical noise.

LAN cables act as antennas that can pick up noise from fluorescent lights, electric motors, electric heaters, photocopiers, refrigerators, elevators, and other electronic devices. Coaxial cable is far less susceptible to noise than twisted pair cable because it is shielded by a conductive sheath. The sheath is electrically grounded to prevent noise from reaching the inner conductor.

The test tool measures impulse noise on the cable under test. Impulse noise is abrupt “spikes” of interference. This noise is caused by electronic devices that run intermittently, such as elevators, photocopiers, and microwave ovens. You can monitor impulse noise in the test tool’s MONITOR mode. The test tool counts impulse noise spikes that have an amplitude greater than the selected impulse noise threshold.

Characteristic Impedance

Characteristic impedance is the impedance that a cable would have if the cable were infinitely long. Impedance is a type of resistance that opposes the flow of alternating current (ac). A cable’s characteristic impedance is a complex property resulting from the combined effects of the cable’s inductive, capacitive, and resistive values. These values are determined by physical parameters such as the size of the conductors, distance between conductors, and the properties of the cable’s insulation material.

Proper network operation depends on a constant characteristic impedance throughout the system’s cables and connectors. Abrupt changes in characteristic impedance, called impedance discontinuities or impedance anomalies, cause signals reflections, which can distort signals transmitted through LAN cables and cause network faults.

Minimizing Impedance Discontinuities

Characteristic impedance is usually altered slightly by cable connections and terminations. Sharp bends or kinks in LAN cable can also alter the cable's characteristic impedance. Networks can operate with small discontinuities because the resulting signal reflections are small and are attenuated in the cable. Larger impedance discontinuities can interfere with data transmission. Such discontinuities are caused by poor electrical contacts, improper cable terminations, mismatched cable or connector types, and by disturbances in the twisting pattern of twisted pair cable.

You can avoid problems with impedance discontinuities by observing the following precautions during installation:

- Never mix cables with different characteristic impedances (unless you use special impedance-matching circuitry).
- Always terminate coaxial cables with a resistance equal to the cable's characteristic impedance. The terminating resistance prevents signal reflections by absorbing the signal's energy.
- When untwisting cable pairs to install connectors or make connections at punch-down blocks, make the untwisted sections as short as possible.
- Do not make sharp bends or kinks in the cable. Check the cable manufacturer's specifications for the minimum bend radius.
- Handle LAN cable carefully during installation. Do not step on the cable or pinch it with tight cable ties.

Crosstalk

Crosstalk is undesirable signal transmission from one cable pair to another nearby pair. Like electrical noise from outside sources, crosstalk can cause communication problems in networks. Of all the characteristics of LAN cable operation, crosstalk has the greatest effect on network performance.

The test tool makes two crosstalk measurements: NEXT and ELFEXT.

NEXT

The test tool measures NEXT (near-end crosstalk) by applying a test signal to one cable pair and measuring the amplitude of the crosstalk signals received by the other cable pairs. The NEXT value, expressed in decibels, is computed as the difference in amplitude between the test signal and the crosstalk signal measured at the same end of the cabling. Higher NEXT values correspond to less crosstalk and better cabling performance.

All signals transmitted through cabling are affected by attenuation. Because of attenuation, crosstalk occurring at the far end of the cabling contributes less to NEXT than crosstalk occurring closer to the signal source. To verify proper cabling performance, NEXT is measured from both ends of the cabling.

FEXT and ELFEXT

FEXT (far-end crosstalk) is the difference between the amplitude of a far end test signal applied to one wire pair and the resulting crosstalk at the near end on a different wire pair. Like NEXT, FEXT is expressed in decibels, and higher FEXT values correspond to better cabling performance.

ELFEXT (equal level far-end crosstalk) is the difference between the FEXT and the attenuation of the disturbed wire pair. Like ACR, ELFEXT is a type of signal-to-noise ratio that indicates the transmission quality of a cable link. The name "Equal Level FEXT" refers to the fact that all FEXT signals are attenuated equally. Figure 7-9 illustrates this important difference between NEXT and FEXT.

Crosstalk signals received far from a transmitter contribute little to NEXT because they are attenuated over a long distance. But all FEXT signals are attenuated by the same amount, so they all contribute equally to crosstalk at the far end.

Because all FEXT signals travel the same distance, they tend to add up in phase. This means that the signals always add up to a worst-case FEXT value.

There can be a difference between the NEXT and FEXT of a link, particularly in the connecting hardware. This difference is due to the nature of the capacitive and inductive currents that cause crosstalk. At a signal source (the near end) these currents can subtract. If the currents subtracted at the near end, they add up at the far end. Thus, a connector that attains high NEXT by balancing the two currents may have very poor FEXT performance.

In cable, the inductive crosstalk component is very low. Most of the crosstalk is due to the capacitive component. Because the difference between the two components is nearly equal to the capacitive component, NEXT and FEXT are nearly the same in a cable.

Because of how FEXT signals add up along a cable link, good ELFEXT performance is critical for systems that transmit data over multiple wire pairs. Examples of these systems are 100BASE-T4, 100VG-AnyLAN, and 1000BASE-T (Gigabit Ethernet).

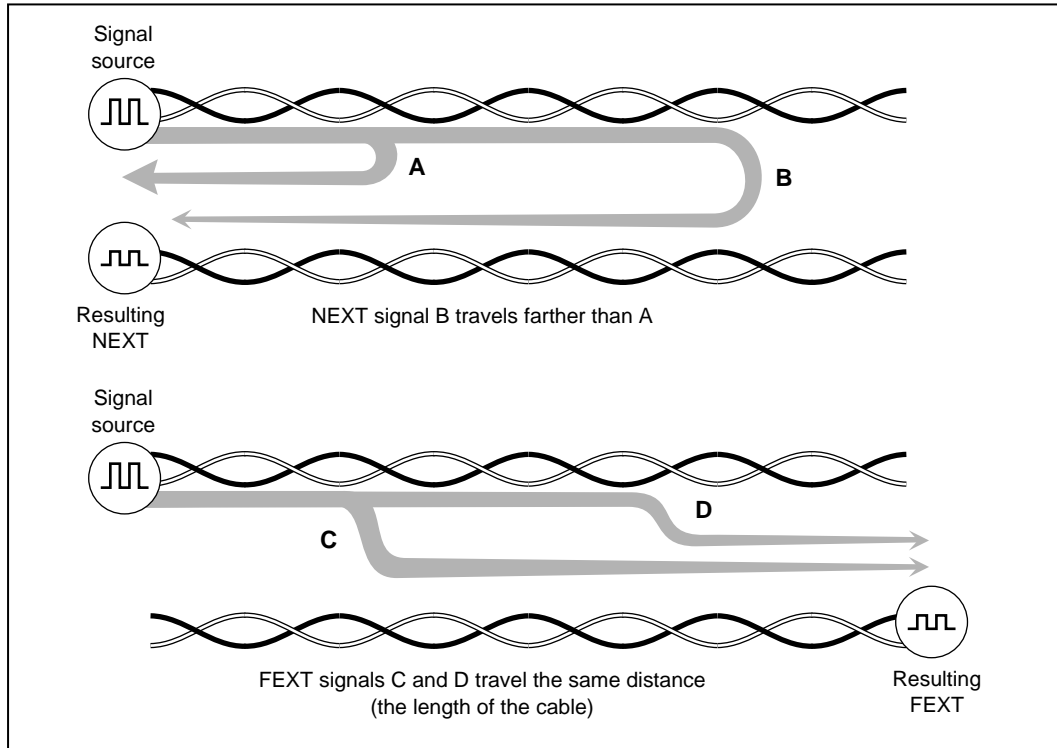

oy70f.eps

Figure 7-9. How FEXT Signals are All Equally Attenuated

Locating NEXT and ELFEXT Problems

If the test tool reports a NEXT or ELFEXT failure on a cable pair, you can use the HDTDIX analyzer to locate the source of the crosstalk problem.

Like the HDTDR results, the HDTDIX analyzer results are presented in both a list and a plot format. The list format shows the cable pairs tested, the peak magnitude of crosstalk detected on the pairs, and the distance to the peak magnitude.

The HDTDIX analyzer plot shows the location and magnitude of all crosstalk sources detected on the cabling. The HDTDIX test uses very short (2 ns) test pulses, which help the test tool resolve smaller crosstalk problems, resulting in more accurate distance-to-fault measurements and better definition of faults on plots. Additionally, the test tool runs the HDTDIX test from both ends of the cabling for improved visibility of far-end crosstalk problems. An example of an HDTDIX analyzer plot from a test on a good twisted pair cable is shown in Figure 7-10.

The plot's horizontal scale represents the distance along the cabling under test. In the example plot, the cursor is placed at a small crosstalk source caused by a connector 77 ft (23.5 m) from the test tool.

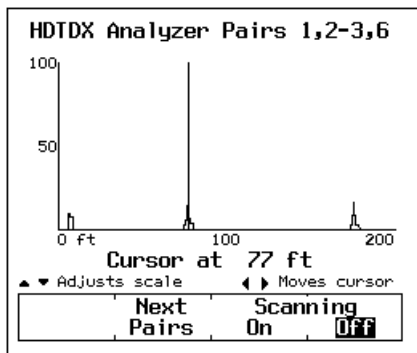

Figure 7-10. An HDTDIX Analyzer Plot

oy32f.bmp

The vertical scale represents the magnitude of the crosstalk detected. The crosstalk levels shown on the plot are adjusted to compensate for cable attenuation. Without this adjustment, the peak on the right side of the plot (farther from the test tool) would appear much smaller. The adjusted plot helps you identify crosstalk sources because you can use the vertical scale to measure crosstalk magnitudes plotted at any distance from the test tool. You can also compare the relative magnitudes of crosstalk peaks to determine the largest sources of crosstalk on the cabling.

The vertical scale increases logarithmically. A level of 50 represents a crosstalk magnitude that is close to causing a failure. The level of 100 is approximately 20 times greater than the level of 50. A level of 100 represents an extremely high level of crosstalk that is typically due to split pairs. Cables or other hardware that cause crosstalk levels of 100 or above are considered unusable. Crosstalk levels near 0 are considered to be inconsequential.

The HDTDX plot from cabling that failed a NEXT test may show one or more peaks of crosstalk greater than a level of 50. A failure can also be caused by a crosstalk level less than 50 if the level is sustained over a substantial distance of the cabling.

Split Pairs and NEXT

A split pair occurs when one wire from a cable pair is twisted together with a wire from a different cable pair. Split pairs most frequently result from miswires at punchdown blocks and cable connectors. Figure 7-11 shows an example of split pair wiring. Notice that the pin-to-pin connections across the cable are correct, but the pairs twisted together do not form a complete circuit.

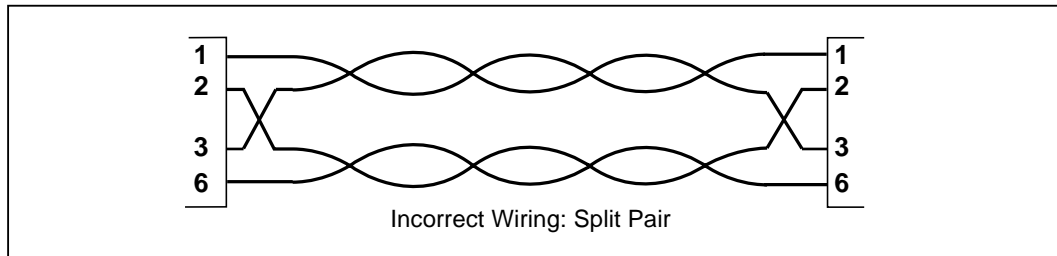

oy33f.eps

Figure 7-11. Split Pair Wiring

Split pairs cause severe crosstalk because the signals in the twisted pairs come from different circuits. The high crosstalk levels produced by split pairs cause low NEXT values during cabling tests. If the NEXT value is low enough, the test tool reports a split pair during the wire map test.

The tool may also report split pairs if you test untwisted cable, such as ribbon cable or untwisted telephone line.

If the tool reports split pairs when you are testing cabling made of multiple segments, you can determine which segment has the split pair by running the HDTDX analyzer. The HDTDX analyzer plot will show a large value of crosstalk starting at a distance that corresponds to the beginning of the segment with the split pair.

Minimizing Crosstalk

Crosstalk problems are minimized by twisting together the two wires in each cable pair. Twisting the two wires together causes the electromagnetic fields around the wires to cancel out, leaving virtually no external field to transmit signals to nearby cable pairs.

You can avoid problems with crosstalk by observing the following precautions during installation:

- When untwisting cable pairs to install connectors or make connections at punch-down blocks, make the untwisted sections as short as possible.
- Be attentive when making wiring connections. Wiring errors that cause split pairs create severe crosstalk problems.
- Do not make sharp bends or kinks in the cable. Check the cable manufacturer's specifications for the minimum bend radius.
- Handle LAN cable carefully during installation. Do not step on the cable or pinch it with tight cable ties.

Power Sum Values

Power sum values, such as PSNEXT, PSELFEXT, and PSACR, show how much a wire pair is affected by the combined interference from the other pairs in the cable. Power sum NEXT values show how much a pair is affected by the combined NEXT from the other pairs. PSELFEXT values show the effects of the combined FEXT. PSACR values show the ratio of a pair's attenuation to the combined NEXT of the other pairs.

Good power sum performance is important for higher speed networks, such as 1000BASE-T, that transmit data in parallel over multiple wire pairs. Though a cable link may not be installed for use with parallel transmission systems, verifying a link's power sum performances helps ensure successful upgrades in the future.

Propagation Delay and Delay Skew

Propagation delay is the time it takes an electrical signal to travel the length of a wire. A wire pair's delay depends on the pair's length, twist rate, and electrical properties, such as the type of insulating material used around the copper conductors. Delays typically measure in the hundreds of nano seconds. (One nano second is one-billionth of a second, or 0.000000001 second.)

The propagation delays of wire pairs in a link can differ slightly because of differences in the number of twists and in the electrical properties of each pair. The delay differences between pairs is called delay skew. Delay skew is a critical parameter for high-speed networks that use parallel data transmission, which involves transmitting data bits simultaneously over multiple wire pairs. If the delay skew between the pairs is too great, the bits arrives out of synchronization and the data cannot be properly reassembled. Systems that use parallel transmission include 100BASE-T4, 100VG-AnyLAN, and 1000BASE-T (Gigabit Ethernet).

Though a cable link may not be intended for parallel transmission, testing for delay skew helps ensure that the link will support upgrades to high-speed networks.

Nominal Velocity of Propagation (NVP)

NVP is the speed of a signal through a cable relative to the speed of light. In a vacuum, electrical signals travel at the speed of light. In a cable, signals travel slower than the speed of light. Typically, the speed of an electrical signal in a cable is between 60 % and 80 % of the speed of light. Figure 7-12 shows how the NVP percentage is calculated.

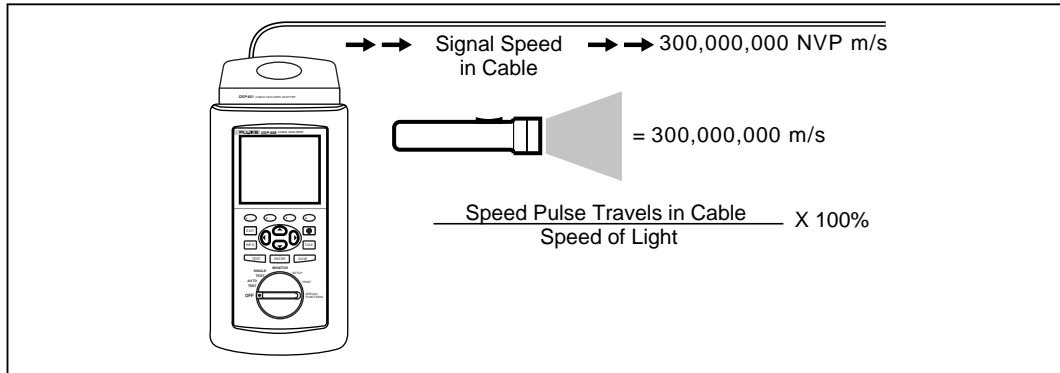

oy34f.eps

Figure 7-12. How NVP is Calculated

NVP values affect the limits on cabling length for Ethernet systems because Ethernet operation depends on the system's ability to detect collisions in a specified amount of time. If a cable's NVP is too low or the cabling is too long, signals are delayed and the system cannot detect collisions soon enough to prevent serious problems in the network.

NVP and Length Measurements

Length measurements depend directly on the NVP value entered for the selected cable type. To measure length, the test tool first measures the time it takes for a test pulse to travel the length of the cabling. The test tool then calculates cabling length by multiplying the travel time by the signal speed in the cable.

Because the test tool uses the length measurement to determine cable resistance limits, the NVP value also affects the accuracy of resistance measurements.

NVP Calibration

The NVP values specified for standard cables are included in the cable specifications stored in the test tool. These values are accurate enough for most length measurements. However, the actual NVP for one cable type can vary up to 20 % between batches because of variations in the manufacturing process.

Therefore, if accurate length measurements are critical to your installation or testing process, you should determine the actual NVP value for each spool of cable. Determining the NVP value involves measuring a known length of cable and adjusting the test tool's length measurement to match the known length. As you adjust the length measurement, the NVP value changes accordingly. The calibration procedure is explained in "NVP Calibration" in Chapter 6.

High-Definition Time Domain Reflectometry (HDTDR)

HDTDR is a measurement technique used to determine cabling length and characteristic impedance and to locate faults along the cabling. Time Domain Reflectometry is sometimes referred to as cable radar because it involves analyzing signal reflections in the cabling.

If a signal traveling through cabling encounters an abrupt change in impedance, some or all of the signal is reflected back to the source. The timing, size, and polarity of the reflected signals indicate the location and nature of impedance anomalies in the cabling.

The test tool applies very short (2 ns) test pulses to the cabling under test. The short pulses help the test tool resolve smaller anomalies, resulting in more accurate distance-to-fault measurements and better definition of faults on plots. The test is run from both ends of the cabling (if the remote is used) for improved visibility of far-end anomalies.

Reflections from Opens

An open, or break, in the cabling represents an abrupt increase in the cabling's impedance. The impedance of an open is nearly infinite. In open cabling, a signal's energy is not dissipated by a terminating impedance, so the signal bounces back towards the source. This reflection appears at the source with the same amplitude and polarity as the original signal, as shown in Figure 7-13. By measuring the amount of time taken for the reflected pulse to return, the test tool can determine the location of the open in the cabling.

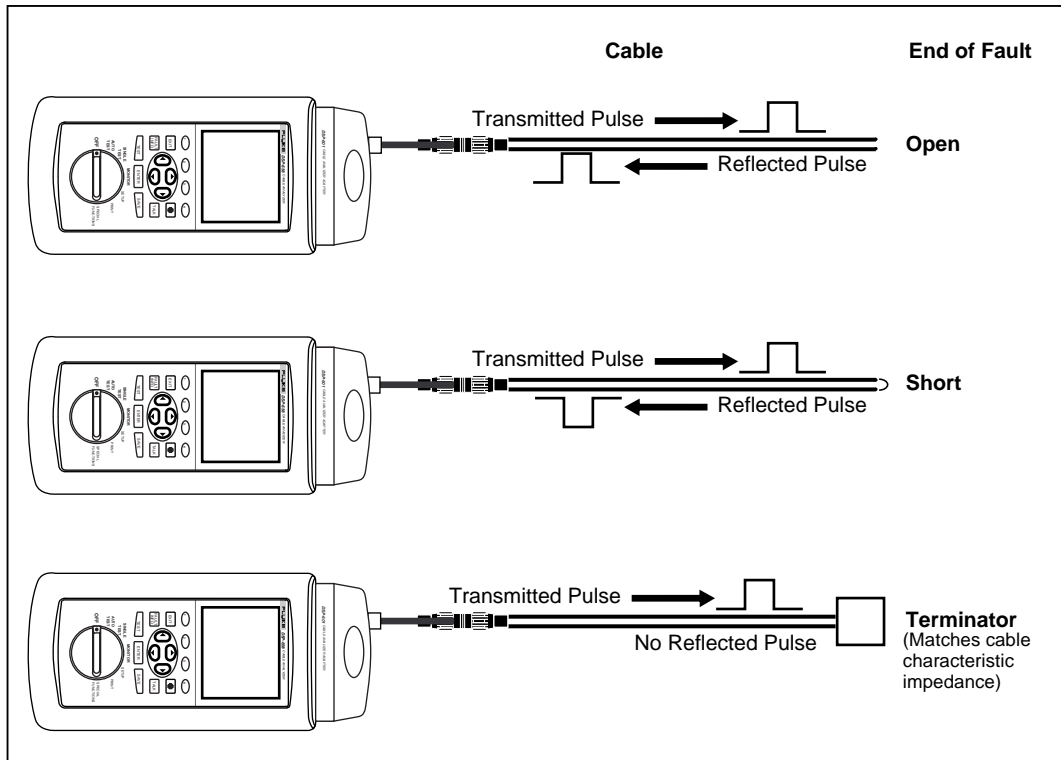

oy35f.eps

Figure 7-13. Signals Reflected from an Open, Shorted, and Terminated Cable

Reflections from Shorts

A short represents an abrupt decrease in the impedance between two conductors in a cable. A short is caused when the insulation surrounding a cable's wires is damaged, allowing the wires to touch each other. The result is a near-zero impedance connection between the conductors.

A short also causes signal reflections, but in a manner opposite of an open. In a shorted cable, the signal's energy is not dissipated because the short's impedance is close to zero. The signal is reflected back to the source, where it appears with the same amplitude but a polarity opposite of the original signal, as shown in Figure 7-13.

Reflections from Other Anomalies

Reflections are also caused by impedance anomalies that measure somewhere between infinite and zero impedance. These anomalies can be caused by mechanical stress that damages cable wire or insulation without causing a complete open or short. They can also be caused by cable mismatches and faulty contacts at connectors or punch-down blocks.

A cable fault that has an impedance higher than the cable's characteristic impedance reflects a signal that has the same polarity as the original signal. If the fault is not a complete open, the amplitude of the reflected signal will be less than the original signal.

If the fault's impedance is lower than the cable's characteristic impedance, but is not a complete short, the reflected signal will have the opposite polarity and less amplitude than the original signal.

Cable Termination

Because signal reflections can distort the shape of communication signals, the unused ends of cable segments must be terminated to prevent reflections. The terminating device is a resistor with a value equal to the cable's characteristic impedance. A signal reaching the terminator is neither reflected nor passed: the signal is absorbed and dissipated by the terminating resistance.

Because the test tool relies on signal reflections to determine cabling length, the tool cannot measure the length of properly terminated cables.

Interpreting the HDTDR Plot

The HDTDR plot has a horizontal scale that represents distance and a vertical scale that represents the percentage of reflection relative to the original signal, as shown in Figure 7-14.

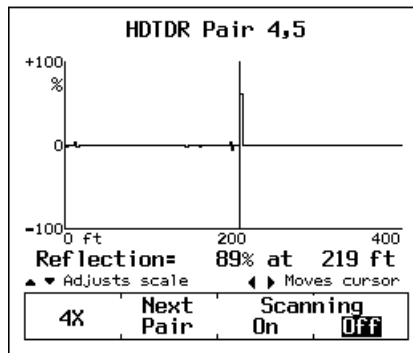

oy36f.bmp



Figure 7-14. An HDTDR Plot

Notice that the reflection percentages can be positive or negative. A positive value indicates that the polarity of the reflection is the same as the polarity of the original signal. As discussed earlier, positive reflections are caused by abrupt increases in the cable's impedance, such as those caused by mismatches in cable types, poor connections, or breaks in the cable.

A negative reflection percentage indicates that the polarity of the reflection is the opposite of the original signal. Negative reflections are caused by abrupt decreases in the cable's impedance, such as those caused by mismatches in cable types or shorts on the cable.

A bi-polar reflection is usually caused by a connector.

The results plotted in Figure 7-14 are the results from an HDTDR test on pair 4,5 in a good twisted pair cable. The results show a positive anomaly caused by the open end of the cable at about 219 feet. Note that the left edge of an HDTDR reflection represents the location of the anomaly on the cable, while the peak of the reflection represents the size of the anomaly.

The test tool's HDTDR plot includes a movable cursor with a readout that displays the cursor's position and the reflection percentage of the anomaly at the cursor's position. You can move the cursor left and right by pressing the   keys on the test tool. Figure 7-14 shows the cursor positioned near the beginning of an anomaly.

ACR

ACR (attenuation to crosstalk ratio) is the difference between NEXT in dB and attenuation in dB. The ACR value indicates how the amplitude of signals received from a far-end transmitter compares to the amplitude of crosstalk produced by near-end transmissions. A high ACR value means that the received signals are much larger than the crosstalk. In terms of NEXT and attenuation values, a high ACR value corresponds to high NEXT and low attenuation.

Figure 7-15 shows a plot of NEXT and attenuation limits, along with the resulting ACR plot. Notice that the ACR is lower where NEXT and attenuation values are near each other.

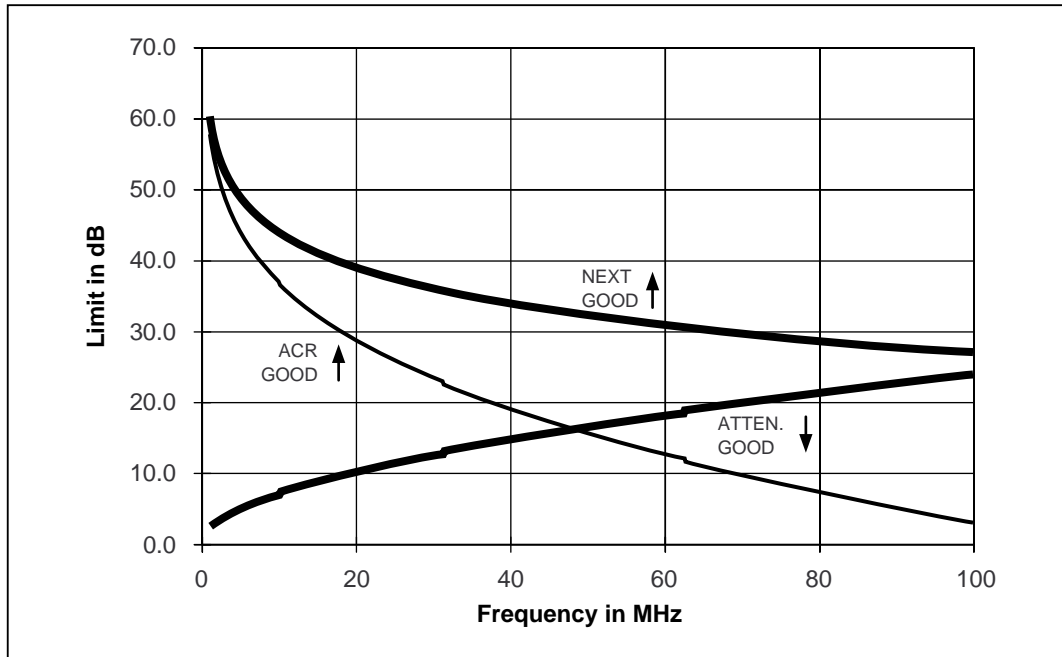

oy37f.eps

Figure 7-15. A Plot of NEXT, Attenuation, and the Resulting ACR

RL

RL (return loss) is the difference between the power of a transmitted signal and the power of the signal reflections caused by variations in the cable's impedance. A RL plot indicates how well a cable's impedance matches its rated impedance over a range of frequencies. High RL values mean a close impedance match, which results in a large difference between the powers of transmitted and reflected signals. Cables with high RL values are more efficient at transmitting LAN signals because little of the signal is lost in reflections.

Good return loss is especially important for high-speed systems, such as Gigabit Ethernet (IEEE 802.3x), that transmit full-duplex (bi-directional) data over individual pairs. Full-duplex transceivers use directional couplers to distinguish between incoming and outgoing signals. If a cable has poor return loss, the couplers might interpret the reflected signals as incoming data, resulting in data errors.

Troubleshooting Basics

Troubleshooting LAN cabling installations is most often required during cabling installation or modification. When cable is handled carefully and installed correctly, it usually operates trouble-free for years.

A general rule for finding cabling faults is as follows: *With very few exceptions, faults occur at cabling connections.* Cabling connections include telecommunication outlets, patch panels, punchdown blocks, and transition connectors.

Connections are the most likely places for faults for at least three reasons: (1) Connections always alter the impedance of the transmission path, (2) connections are likely places for faults caused by wiring errors and faulty or incompatible hardware installation, and (3) connections always cause some crosstalk due to the untwisting of cable pairs.

When cable is handled carelessly, faults can occur in the middle of the cable. These faults can happen when the cable is stepped on, sharply bent, pinched by cable ties or other hardware, or otherwise stressed.

A general procedure for finding cabling faults (excluding sources of noise and traffic faults) involves the following steps:

1. Run an Autotest on the cabling.
2. If the Autotest fails, press  for specific information on the fault.
3. Inspect the cabling for the suggested fault at the location indicated by the diagnostics display.
4. Repair any faults you find. To quickly check your repair, run the test that failed as a Single Test.
5. Run the Autotest again to verify the cabling's performance.

Table 7-1 on the next four pages shows examples of test tool displays for some typical cabling faults.

Table 7-1. Identifying Cabling Faults

Test Failure	Likely Causes of Failure
Wire map: open	Wires connected to wrong pins at connector or punchdown blocks. Faulty connections. Cables routed to the wrong location. Wires broken by stress at connections. Damaged connector. Cuts or breaks in cable.
Wire map: split pair	Wires connected to wrong pins at connector or punchdown blocks.
Wire map: reversed pairs	Wires connected to wrong pins at connector or punchdown blocks.
Wire map: crossed pairs	Wires connected to wrong pins at connectors or punchdown blocks. Mix of 568A and 568B wiring standards (1, 2 and 3, 6 crossed). Crossover cables used where not needed (1, 2 and 3, 6 crossed).

Table 7-1. Identifying Cabling Faults (continued)

Wire Map Display	Diagnostics Display <small>(FAULT INFO)</small>	Plot
 <p>Wire map display showing an open on wire 1 near the main unit.</p>	 <p>Pin 1 Open Check Connector</p> <p>View HDTDR</p> <p><small>oy57i.bmp</small></p>	 <p>HDTDR Pair 1,2</p> <p>Reflection= 68% at 9 ft ▲ ▼ Adjusts scale ◀ ▶ Moves cursor</p> <p>4X Next Pair</p> <p><small>oy58i.bmp</small></p>
 <p>Wire map display showing a split pair on pairs 3,6 and 4,5.</p>	 <p>Pairs 3,6-4,5 Split Check Wiring</p> <p>View HDTDX</p> <p><small>oy59i.bmp</small></p>	 <p>HDTDX Analyzer Pairs 3,6-4,5</p> <p>Cursor at 100 ft ▲ ▼ Scale Up/Down ◀ ▶ Moves cursor</p> <p>Next Pairs</p> <p><small>oy60i.bmp</small></p>
 <p>Wire map display showing reversed pair on pair 1,2.</p>	 <p>Pair 1,2 Goes to Pair 2,1 Check Connector Check Wiring</p> <p><small>oy74i.bmp</small></p>	
 <p>Wire map display showing crossed pairs on 1,2 and 3,6.</p>	 <p>Pair 1,2 Goes to Pair 3,6 568A Goes to 568B Crossover Cable Used</p> <p><small>oy75i.bmp</small></p>	

Table 7-1. Identifying Cabling Faults (continued)

Test Failure	Likely Causes of Failure
Wire map: short	Wires connected to wrong pins at connector or punchdown blocks. Conductive material stuck between pins at a connection. Damage to cable insulation.
NEXT or ELFEXT	Excessive untwisting of pairs at connection. Insufficient quality of connecting hardware. Damage to cable (pinches, kinks, etc.). Damaged connector. Insufficient cable quality.
Impedance anomaly detected	Poor connection between two lengths of cable. Damage to cable (pinches, kinks, etc.) Taps into wire pair. (Twisted pair cable should never be tapped.) Excessive loading at coaxial cable tap. Mismatch of cable types. Incorrect terminator value.

Table 7-1. Identifying Cabling Faults (continued)

Wire Map Display	Diagnostics Display (FAULT INFO)	Plot
 <p>Wire map display showing short between pins 1 and 3.</p>	 <p>Pin 1 Shorted</p> <p>Check Connector</p> <p>View HDTDR</p> <p>oy64i.bmp</p>	 <p>HDTDR Pair 1,2</p> <p>Reflection= 44% at 140 ft</p> <p>4X Next Pair</p> <p>oy65i.bmp</p>
<p>NEXT test fails.</p>	 <p>Pairs 1,2-3,6 NEXT Failure</p> <p>Cable may be Bad</p> <p>Check Connector</p> <p>View HDTDX</p> <p>oy66i.bmp</p>	 <p>HDTDX Analyzer Pairs 1,2-3,6</p> <p>Cursor at 118 ft</p> <p>Next Pairs</p> <p>oy67i.bmp</p>
<p>Impedance anomaly is detected.</p> <p>HDTDR plot shows an impedance anomaly caused by a 150 Ω cable segment in a 100 Ω run.</p>	 <p>Pair 3,6 Impedance Anomaly</p> <p>Check Wiring</p> <p>View HDTDR</p> <p>oy68i.bmp</p>	 <p>HDTDR Pair 3,6</p> <p>Reflection= 9% at 71 ft</p> <p>4X Next Pair</p> <p>oy70i.bmp</p>

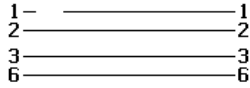
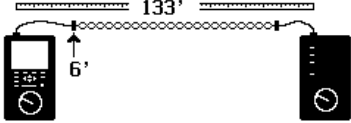
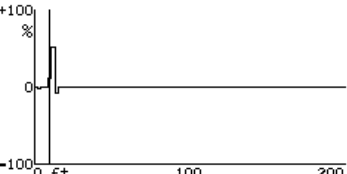
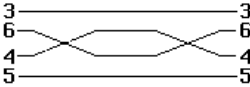
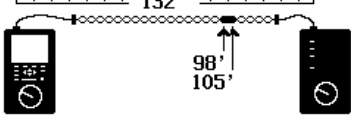
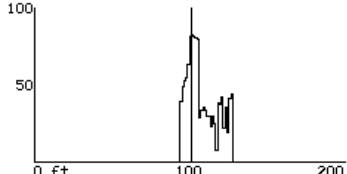
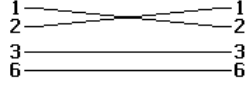
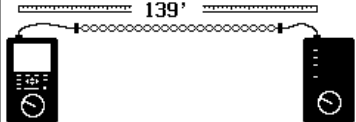
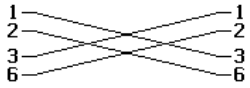
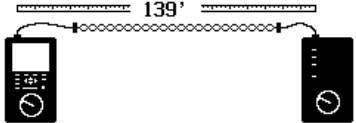
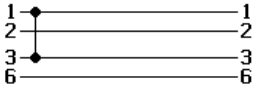
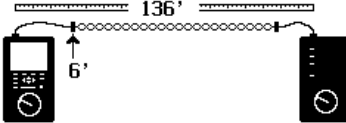
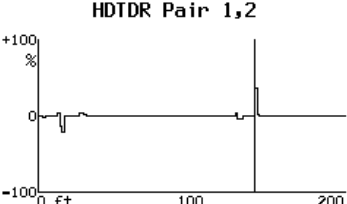
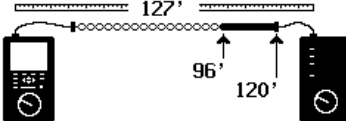
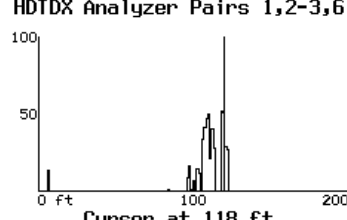
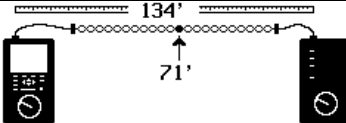
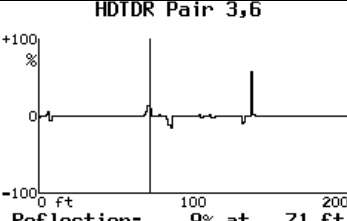
Chapter 8

Maintenance and Specifications

Chapter 8 provides the following information:

- Instructions for cleaning and storing the test tool.
- Instructions for replacing batteries.
- A troubleshooting guide to use when the test tool is not operating correctly.
- Instructions for returning the unit for repair.
- A list of replacement parts and accessories.
- Electrical and mechanical specifications.

Getting Software Upgrades

Keeping your test tool's software current gives you access to new features and the latest test standards. Software upgrades are available for free on the Fluke Networks website. See the online help in LinkWare for information on installing upgrades.

Maintenance

⚠ Warning

To avoid possible fire, electric shock, personal injury, or damage to the test tool

- **Use only specified replacement parts.**
- **Do not let water get into the case.**
- **Remove all input signals before opening the case.**
- **Use only Fluke Networks authorized service centers.**

Cleaning and Storage

Clean the test tool and remote with a soft cloth dampened with water or water and a mild soap.

Caution

To avoid damaging the display or the case, do not use solvents or abrasive cleansers.

If you are storing the test tool or remote for an extended period of time, charge the NiMH battery pack before storing. Do not remove the battery pack. Removing the battery pack for extended periods shortens the life of the backup lithium battery.

Replacing the NiMH Battery Pack

Replace the NiMH battery pack when its life between full charges becomes noticeably shorter. The battery is normally good for up to 1,000 charge/discharge cycles. Figure 8-1 shows how to remove the battery pack.

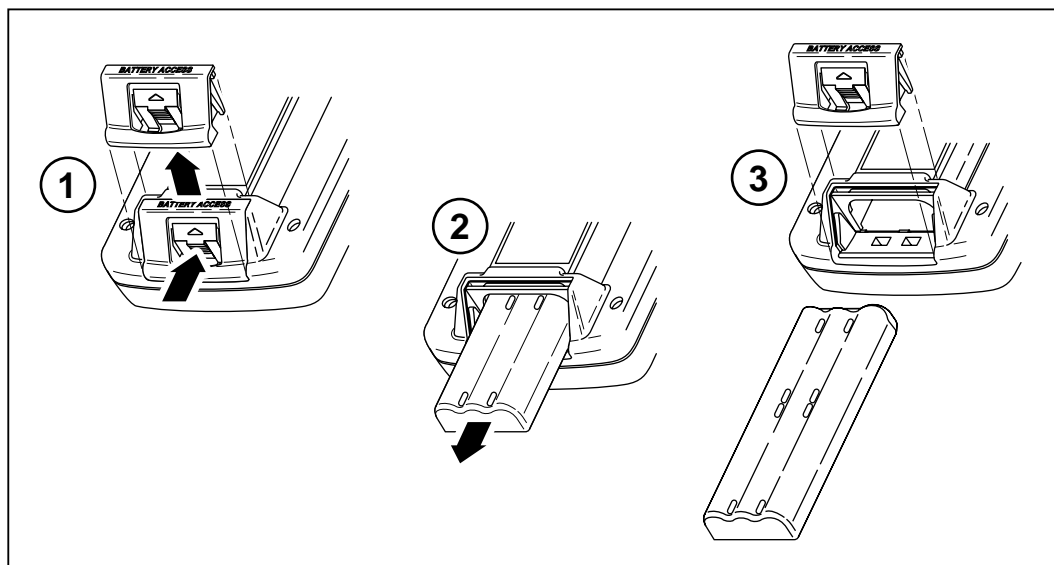

oy39f.eps

Figure 8-1. Removing the NiMH Battery Pack

Note

The ac adapter/charger will not power the test tool when the battery pack is removed.

Internal Lithium Backup Battery

A lithium battery maintains the test tool's memory contents when you remove the NiMH battery pack. The memory contents maintained are the stored Autotest reports, all SETUP settings, self-calibration and NVP calibration data, custom test configurations, and the report identification information.

The lithium battery lasts about five years if you always keep the main battery installed. Removing the main battery pack for extended periods shortens the life of the lithium battery.

When the lithium battery voltage is low, have the battery replaced at a Fluke Networks Service Center. See the later section "Service Center Repair" for shipping and warranty information.

If the Test Tool Fails

If the test tool does not operate properly, refer to Table 8-1 on the next page for troubleshooting procedures. If the self-test fails, return the unit for service as described in "Service Center Repair."





Service Center Repair

If the test tool requires service, call an authorized Fluke Networks Service Center for return instructions.

A test tool covered under warranty will be promptly repaired or replaced (at Fluke Network's option) and returned to you, postage paid, at no charge. See the registration card for warranty terms. If the warranty has lapsed, Fluke Networks will repair the test tool for a fixed fee and return it to you postage paid. Contact the nearest Service Center for information and repair prices.

To contact Fluke Networks, refer to "Contacting Fluke Networks" in Chapter 1.

Table 8-1. Troubleshooting the Test Tool

<p>Symptom 1: Display is blank</p> <p>Press . The test tool may have switched to low-power mode.</p> <p>Connect the ac adapter/charger. The battery pack may need charging.</p> <p>Hold down  for 2 seconds, then hold down  for 5 seconds. The display contrast may be too low.</p> <p>Hold down  for 2 seconds, then hold down  for 5 seconds. The display contrast may be too high.</p>
<p>Symptom 2: Remote unit is not detected.</p> <p>Charge or replace the battery in the remote.</p> <p>Verify that the cable is securely connected to the main and remote units.</p> <p>Connect the remote with a different cable. The cable you are using may be defective.</p> <p>Check the connectors on the main and remote units for damage.</p>
<p>Symptom 3: Test results appear to be incorrect.</p> <p>Perform a self-test to verify correct operation. See “Performing a Self-Test” in Chapter 2 for details.</p> <p>Verify that the test standard, cable type, temperature, and power line frequency (all in SETUP) are correctly set. See Chapter 2 for details.</p> <p>Perform a self-calibration. See “Calibrating the Test Tool” in Chapter 6 for details.</p> <p>Perform a NVP calibration. See “Calibrating the NVP Value” in Chapter 6 for details.</p>
<p>Symptom 4: Internal fault detected.</p> <p>Note any error number displayed. Turn the unit off, then turn it on again. Stored data may be lost.</p> <p>If the error occurs again, contact a Fluke Networks Service Center for assistance.</p>
<p>Symptom 5: Test tool does not operate with ac adapter/charger connected.</p> <p>Verify that the NiMH battery pack is installed. The ac adapter/charger will not power the test tool if the battery is removed.</p> <p>Turn off the test tool; then charge the battery for about 30 minutes before resuming operation.</p> <p>Replace the NiMH battery pack.</p>
<p>Symptom 6: Self calibration fails.</p> <p>See “Calibrating the Test Tool” in Chapter 6 for details.</p>
<p>Symptom 7: Test tool is locked in the power-on sequence.</p> <p>Turn off the test tool; then charge the battery for about 30 minutes before resuming operation.</p>

Replacement Parts

Table 8-2 lists the replacement parts for the test tool and the remote. Other parts may be available through a Fluke Networks service center. To order replacement parts, contact Fluke Networks as described in Chapter 1.

Refer to the Fiber Test Adapters users manual for replacement parts for an optional fiber test adapter.

Table 8-2. Replacement Parts

Description	Part Number
NiMH battery pack	668225
AC adapter/charger, North America version	106200
AC adapter/charger, international version	944223
Battery door, main unit and remote, blue plastic	1992028
DSP-4000 Calibration Module	675611
Multimedia card reader, USB interface	DSP-MCR-U
Cable, 50 Ω BNC coaxial, 1 m (3')	927876
Cable, 9-pin PC interface	944806
Adapter, RJ45 to BNC	642402
Lens for main unit, DSP-4000	662590
Lens for main unit, DSP-4100	1575876
Lens for main unit, DSP-4300	1627114
Lens for remote, DSP-4000	662608
Lens for remote, DSP-4100	1575883
Lens for remote, DSP-4300	1627008
Bail, blue plastic	1992037
Strap	946769
Soft carrying case	669655

Table 8-2. Replacement Parts (cont.)

Description	Part Number
Carrying case for multimedia cards	1620592
DSP-4000 Series Getting Started Guide	2093912
DSP-4000 Series Manual CD	1627320
LinkWare software CD*	LinkWare
* You may also download this software from the Fluke Networks website.	

Note

For a list of the optional link interface adapters currently available, refer to the sheet included with your test tool. Or, visit the Fluke Networks website at www.flukenetworks.com.

Options and Accessories

Table 8-3 lists the options and accessories available for the test tool.

Note

For the latest list of accessories, visit the Fluke Networks website at www.flukenetworks.com.

Table 8-3. Options and Accessories

Description	Model Number
DSP-LIA011S Basic Link Adapters for Cat 5E (2 per set)	DSP-LIA011S
DSP-LIA012S Channel Adapters for Cat 6 (2 per set)	DSP-LIA012S
DSP-LIA013 Channel/Traffic Adapter for Cat 6	DSP-LIA013
DSP-LIA101 Permanent Link Adapters (2 per set)	DSP-LIA101S
Personality Module for Permanent Link Adapter	PM01*
Personality Module for Permanent Link Adapter	PM02*
DSP-PLCAL Automated Calibration Kit (for DSP-LIA101 permanent link adapters)	DSP-PLCAL
*Visit the Fluke Networks website for applications of available modules.	

Table 8-3. Options and Accessories (cont.)

Description	Model Number
DSP-FTA410S Fiber Test Adapter (multimode LED source, 850 nm and 1300 nm)	DSP-FTA410S
DSP-FTA420S Fiber Test Adapter (multimode LED source, 850 nm and 1300 nm)	DSP-FTA420S
DSP-FTA430S Fiber Test Adapter (singlemode laser source, 1310 nm and 1550 nm)	DSP-FTA430S
DSP-FTA440S Fiber Test Adapter (850 nm VCSEL source and 1310 nm FP laser source)	DSP-FTA440S
Multimedia card reader	DSP-MCR
16 MB multimedia card	DSP-MMC16
30 MB multimedia card	DSP-MMC32
Fiber jack accessory kit, small form factor, 62.5 μm multimode	NFK1-FJ
LC accessory kit, small form factor, 62.5 μm multimode	NFK1-LC
MT-RJ accessory kit, small form factor, 62.5 μm multimode	NFK1-MTRJ
VF-45 accessory kit, small form factor, 62.5 μm multimode	NFK1-VF45
External charger for NiMH battery	BC7217
Soft carrying case	C791
DSP-FTK (fiber test kit: meter and multimode source)	DSP-FTK
LS-1310/1550 Laser Source	LS-1310/1550
140 A-Bug Tone Probe	140 A-Bug
FT120 (200X) or FT140 (400X) Optical Fiber Inspection Scope	FT120 or FT140

Specifications

⚠ Warning

Under no circumstances is this product intended for direct connection to telephony inputs, systems, or equipment, including ISDN inputs. Doing so is a misapplication of this product, which could result in damage to the test tool and create a potential shock hazard to the user.

Under no circumstances should the CABLE TEST input be connected to LAN inputs, systems, or equipment. Doing so is a misapplication of this product, which could result in damage to the test tool and create a potential shock hazard to the user.

Calculated Measurement Accuracy

All Basic Link, Permanent Link, and Channel “Measurement Accuracy” specifications are calculated from the individual parameters using formulas defined in draft TIA guidelines. These TIA guidelines are currently in draft form, and future revisions may cause the calculated accuracies to change. This manual uses the TIA guidelines available at the time of printing for calculating Measurement Accuracy.

Traceable Calibration Period

One year.

Self-Calibration Period

To ensure maximum accuracy of test results, perform the self-calibration procedure, as described in “Calibrating the Test Tool” in Chapter 6, every 30 days.

Notes

All specifications for tests on twisted pair cabling apply to cable with 100 Ω of characteristic impedance. Contact Fluke Networks for information on measurement performance on cabling with characteristic impedance other than 100 Ω .

Compatibility with Remotes and Link Interface Adapters

The DSP-4100 and DSP-4300 test tools are compatible only with DSP-4100SR and DSP-4300SR remote units, respectively. The DSP-4100 and DSP-4300 remotes are not compatible with DSP-100, DSP-2000, or DSP-4000 test tools. The LIAs are not compatible with DSP-100 or DSP-2000 test tools.

The test tool can store calibration data for two different remotes.

Standard Link Interface Adapters

DSP-LIA011 Basic Link Adapter for Cat 5E

Plug type and life: shielded Cat 5E RJ45; >5000 insertions

Cable type: 100 Ω Cat 6 SsTP

Test supported: shielded and unshielded cable, TIA Cat 3, 4, 5, and 5E basic links, and ISO/IEC, EN50173 Class C and D permanent links

DSP-LIA012 Channel Adapter for Cat 6

Plug type and life: shielded RJ45; >5000 insertions

Tests supported: shielded and unshielded cable, TIA Cat 3, 4, 5, 5E, and 6 channels, and ISO/IEC Class C and D channels

DSP-LIA013 Channel/Traffic Adapter for Cat 6

Plug type and life: shielded RJ45; >5000 insertions

Tests supported: shielded and unshielded cable, TIA Cat 3, 4, 5, 5E, and 6 channels, ISO/IEC Class C and D channels

Also performs LAN traffic tests (see specifications for LAN traffic monitoring)

DSP-LIA101 Permanent Link Adapter for Cat 6

Personality module plug type and life: shielded Cat 6 RJ45; >5000 insertions

Test supported: shielded and unshielded cable, TIA Cat 3, 4, 5, 5E, and 6, and ISO/IEC, EN50173 Class C, D, and E permanent links

Cable Types Tested

Shielded and unshielded twisted pair (STP and UTP) LAN cabling:

TIA Category 3, 4, 5, 5E, and 6	100 Ω
ISO/IEC Class C and D	100 Ω and 120 Ω

Foil-screened twisted pair cables (ScTP):

TIA Category 3, 4, 5, 5E, and 6	100 Ω
ISO/IEC Class C and D	100 Ω and 120 Ω

Shielded twisted pair cables (STP): 150 Ω

(IBM Type 1, 6, and 9; IBM interface adapter required).

Coaxial cables (connect with the RJ45 to BNC adapter):

Thicknet (10BASE5; adapter required)

Thinnet (10BASE2)

RG-58, RG-58 foam, RG-59, RG-59 foam, RG-8, RG-8A/U, and RG-62.

Note

For availability of additional adapters that allow testing to other performance standards, different cabling types, or fiber optic cabling, contact Fluke Networks.

Test Standards

Test Standard	Link Type
TIA Category 3 and 5E per Addendum #5 to TIA/EIA-568A	basic link or channel
TIA Category 5 (new) per TIA TSB-95	basic link or channel
TIA Category 6 per TIA Addendum #1 to TIA/EIA-568B (draft)	permanent link or channel
ISO/IEC-11801-2000 Class C and D (new)	permanent link or channel
ISO/IEC-11801-2000+ Class E (draft)	permanent link or channel
STP cabling, (IBM Type 1, 150 Ω) ANSI TP-PMD IEEE 802.3 10BASE5, 10BASE2	Ethernet with coaxial cabling
IEEE 802.3 10BASE-T, 100BASE-TX, 1000BASE-T	Ethernet with twisted pair cabling
IEEE 802.5	Token Ring, 4 Mb/s or 16 Mb/s

Additional test standards are available. Contact Fluke Networks for information.

Fiber optic test standards are supported when using the optional Fiber Test Adapters. See those products' manuals for more information.

Time for Autotest

Full 2-way Autotest of Category 5 UTP cable in approximately 10 seconds.

Length

	Twisted Pair Cable		Coaxial Cable	
Range	0 ft to 328 ft (0 m - 100 m)	328 ft to 2500 ft (100 m - 762 m)	0 ft to 328 ft (0 -100 m)	328 ft to 4000 ft (100 m - 1219 m)
Resolution	1 ft or 0.1 m	1 ft or 0.1 m	1 ft or 0.1 m	1 ft or 0.1 m
Accuracy	\pm (1 ft (0.3 m) + 2 % of reading)	\pm (1 ft (0.3 m) + 4 % of reading)	\pm (1 ft (0.3 m) + 2 % of reading)	\pm (1 ft (0.3 m) + 4 % of reading)

Note

Specifications are relative to calibrated value using a representative reference cable. Variations occur because of variations in the cable manufacturing process.

Propagation Delay

	Twisted Pair Cable		Coaxial Cable	
Range	0 ns to 500 ns	500 ns to 3800 ns	0 ns to 500 ns	500 ns to 6000 ns
Resolution	1 ns	1 ns	1 ns	1 ns
Accuracy	\pm (5 ns + 2 % of reading)	\pm (5 ns + 4 % of reading)	\pm (5 ns + 2 % of reading)	\pm (5 ns + 4 % of reading)

Delay Skew

	Twisted Pair Cable
Range	0 ns to 100 ns
Resolution	1 ns
Accuracy	\pm 10 ns

DC Loop Resistance Test

Range: 0 Ω to 400 Ω

Accuracy: \pm (2 Ω + 2 % of reading)

Resolution: 0.1 Ω

Overload recovery time: Less than 10 minutes to rated accuracy following an overvoltage. Self-calibration is required after repeated or prolonged overvoltage.

Measurement Accuracy as Specified in Relevant Standards

Accuracies computed from the parameters in Table 8-4 are shown in Figures 8-2 through 8-7.

Table 8-4. Performance Parameters

Parameter	Baseline Test Tool	Test Tool with DSP-LIA101 Permanent Link Adapter	Test Tool with Category 6/Class E Channel Adapter
Dynamic range	3 dB over test limit Pair-to-Pair NEXT and FEXT loss 65 dB Power Sum NEXT and FEXT loss 62 dB		
Amplitude resolution	0.1 dB		
Frequency range and resolution	1 MHz – 31.25 MHz: 100 kHz 31.25 MHz–100 MHz:200 kHz 100 MHz – 250 MHz: 500 kHz		
Dynamic Accuracy NEXT Attenuation (Insertion Loss)	± 0.75 dB ^{Note 1}		
Dynamic Accuracy ELFEXT	± 1.0 dB ^{Note 2}		
Source/load return loss	$20 - 12.5 \log(f / 100)$ 20 dB maximum	$18 - 12.5 \log(f / 100)$ 20 dB maximum	
Random Noise Floor	$75 - 15 \log(f / 100)$; 85 dB maximum		
Residual NEXT	$65 - 20 \log(f / 100)$ ^{Note 3}	$54 - 20 \log(f / 100)$ ^{Note 3}	
Residual FEXT	$65 - 20 \log(f / 100)$ ^{Note 3}	$45 - 20 \log(f / 100)$ ^{Note 3}	
Output Signal Balance	$40 - 20 \log(f / 100)$ ^{Note 4}	$37 - 20 \log(f / 100)$ ^{Note 4}	
Common Mode Rejection	$40 - 20 \log(f / 100)$ ^{Note 4}	$37 - 20 \log(f / 100)$ ^{Note 4}	
Tracking	± 0.5 dB		
Directivity	$27 - 7 \log(f / 100)$ ^{Note 5} 30 dB maximum	$25 - 20 \log(f / 100)$ 25 dB maximum	
Source Match	20 ^{Note 5}	$20 - 20 \log(f / 100)$ 20 dB maximum	
Return loss of Termination	$20 - 15 \log(f / 100)$ ^{Note 5} 25 dB maximum	$16 - 15 \log(f / 100)$ 25 dB maximum	

Notes for Table 8-4

1. Verification of dynamic accuracy is required up to the specified range for NEXT loss and FEXT loss.
2. The dynamic accuracy is based on dynamic accuracy performance for insertion loss (attenuation) and NEXT loss, and is assumed to combine the dynamic accuracy for ELFEXT as specified. The FEXT loss dynamic accuracy is tested to ± 0.75 dB.
3. Performance verification of residual NEXT and residual FEXT is up to 85 dB maximum, with an assumed frequency response change of 20 dB/decade.
4. Performance verification of Output Signal Balance and Common Mode Rejection is up to 60 dB maximum, with an assumed frequency response change of 20 dB/decade.
5. The performance requirements for tracking, directivity, and source match for the permanent link adapter apply after the permanent link adapters have been calibrated with the test tools they are attached to.

Typical Measurement Accuracies

The DSP-4000 Series test tools substantially exceed the measurement accuracy requirements of draft Level III TIA and IEC proposals. Typical measurement accuracy is determined as follows:

- For each performance parameter (for example, source/load return loss, residual NEXT, etc.) at every frequency, the **worst result for any wire pair or wire-pair combination** is obtained.
- The values of the **worst case wire pair or wire pair combinations** are substituted in the accuracy equation given by TIA and IEC guidelines.
- **Worst case** assumptions for **link performance** that affect measurement accuracy are used. These include the assumptions for link return loss, common-mode-to-differential-mode gain, and differential-to-common-mode gain.

Typical measurement accuracies are used to determine if test results are within the test tool's accuracy range. Results within the accuracy range are marked with an asterisk.

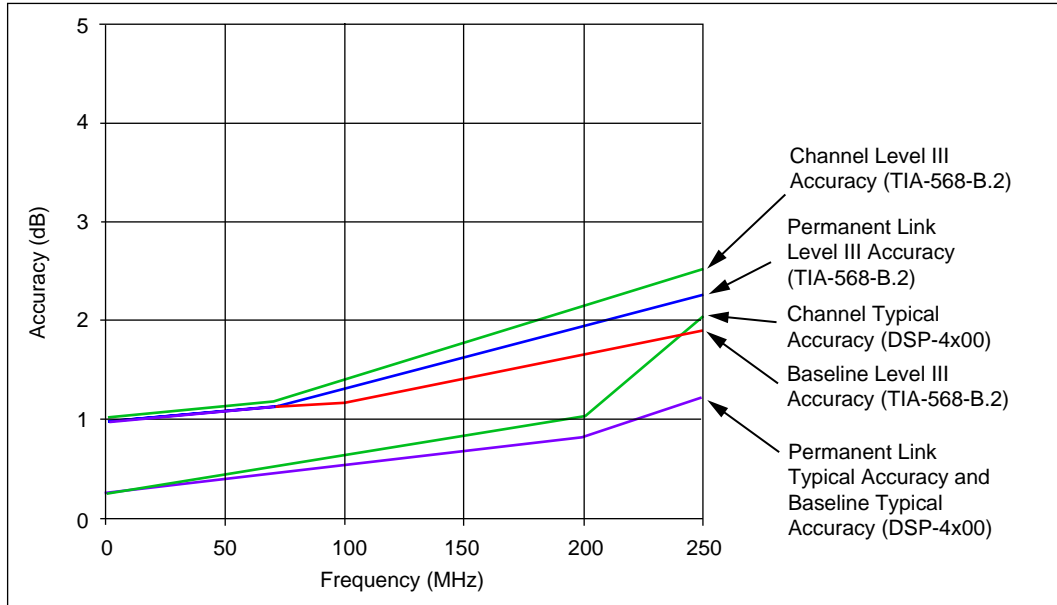

oy88.eps

Figure 8-2. Attenuation (Insertion Loss) Measurement Accuracy for Channel

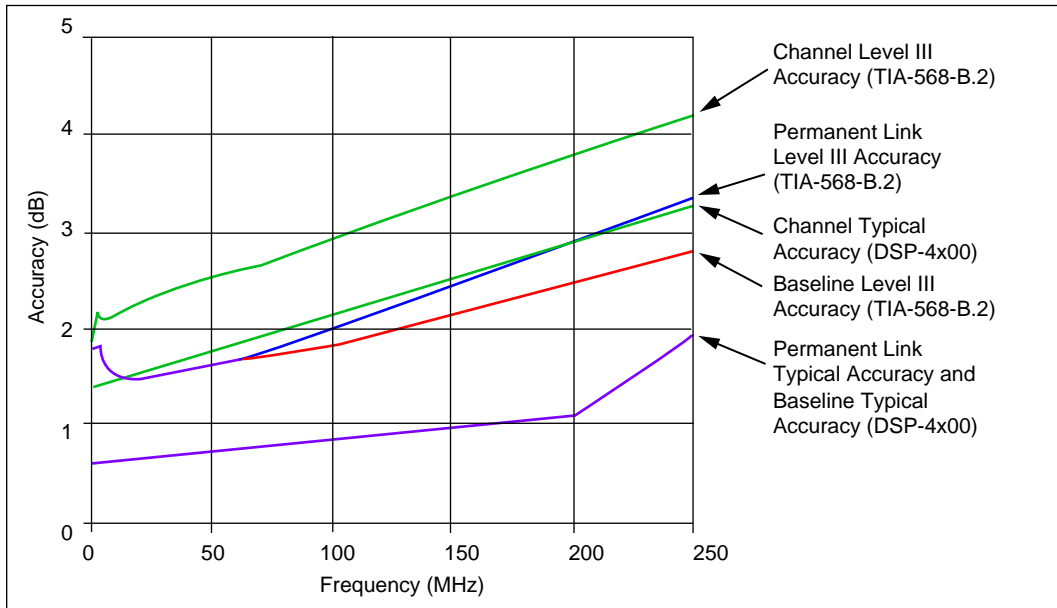

oy89.eps

Figure 8-3. Pair-to-Pair NEXT Measurement Accuracy for a Channel

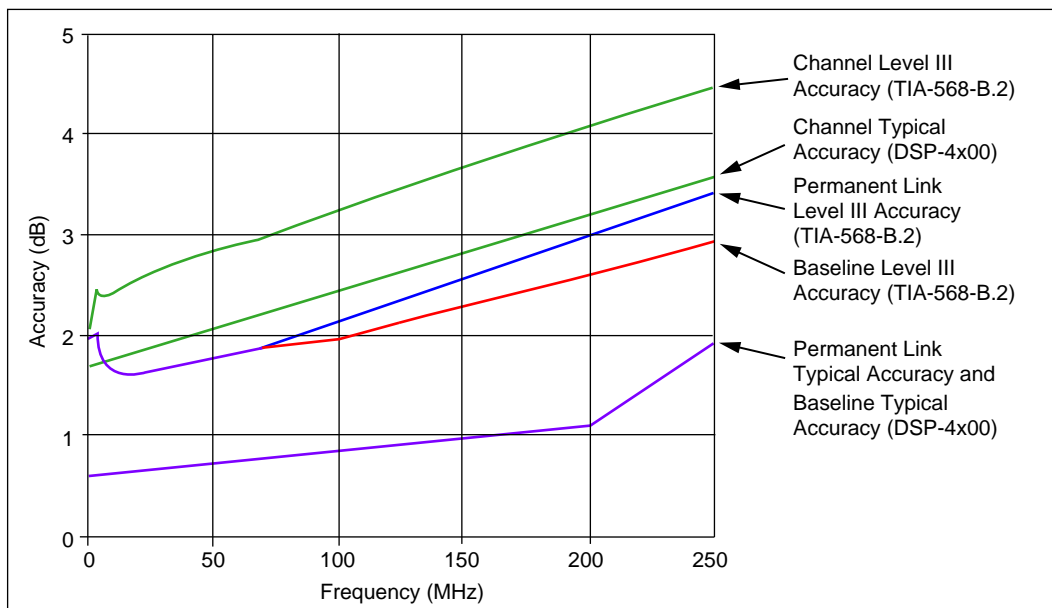

oy93.eps

Figure 8-4. PSNEXT Measurement Accuracy for Channel

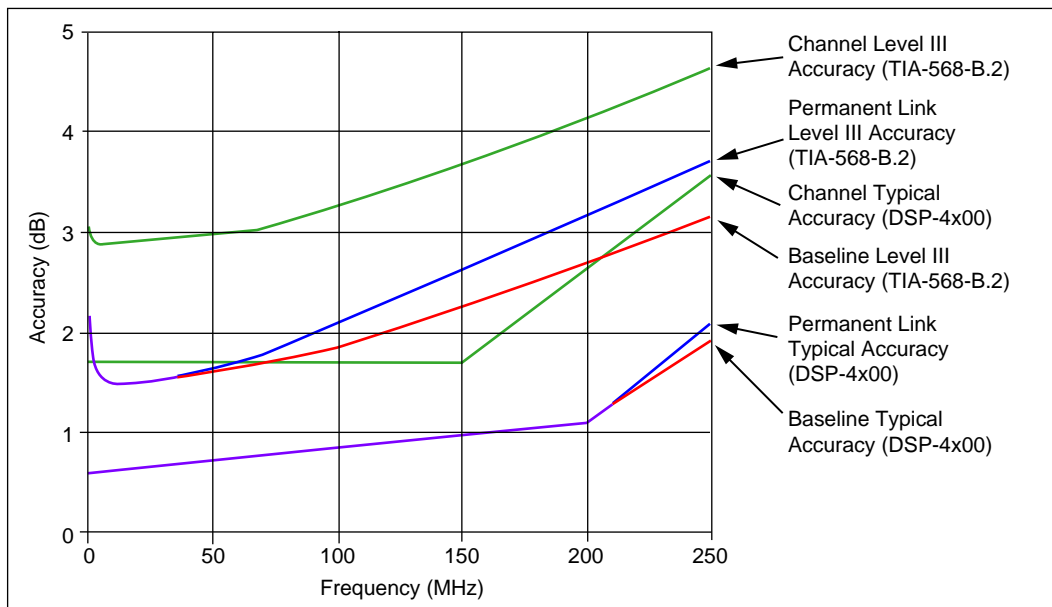

oy90.eps

Figure 8-5. Pair-to-Pair ELFEXT Measurement Accuracy for Channel

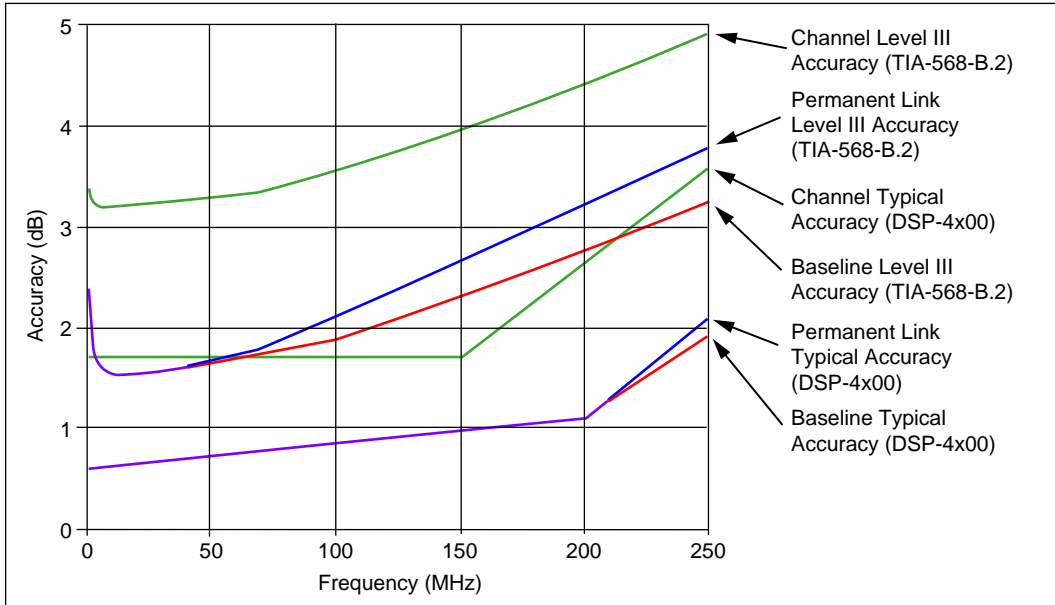

Figure 8-6. PSELFEXT Measurement Accuracy for Channel

oy91.eps

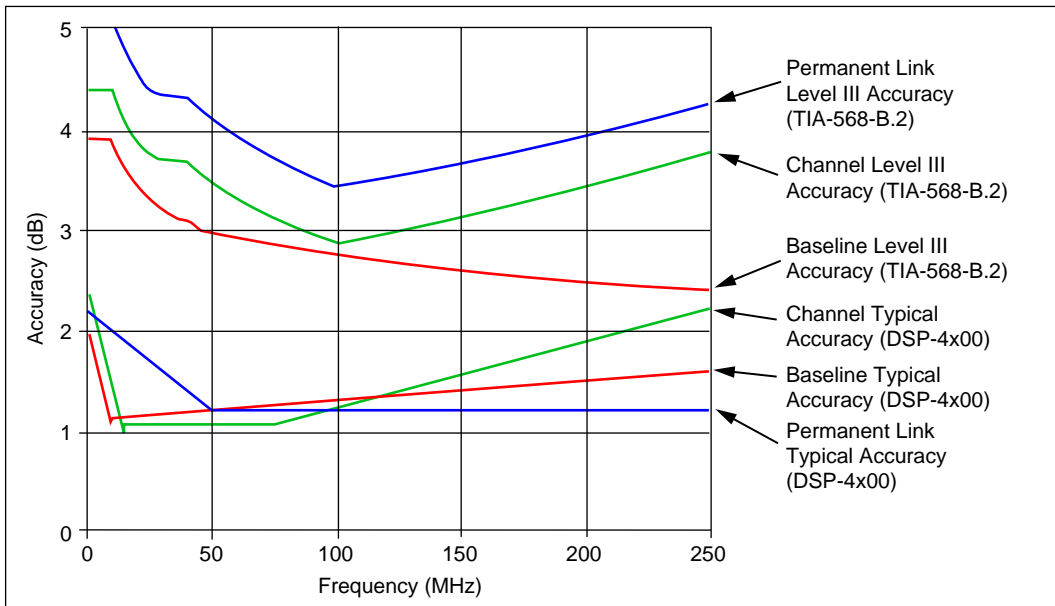

Figure 8-7. Return Loss Measurement Accuracy for Channel

oy92.eps

Note

The 3 dB rule generally applies at low frequencies.

HDTDTMX Analyzer Specifications for Cables <100 m (328 ft)

The following performance is typical for cables less than 100 m (328 ft):

Distance accuracy: $\pm(1 \text{ ft (0.3 m)} + 2 \% \text{ distance})$

Distance resolution: 1 ft or 0.1 m

HDTDRTM Specifications for Cables <100 m (328 ft)

The specifications below are for HDTDR tests on cables less than 100 m (328 ft) long.

	Twisted Pair Cable	Coaxial Cable
Distance accuracy	$\pm(1 \text{ ft (0.3 m)} + 2 \% \text{ distance})$	$\pm(1 \text{ ft (0.3 m)} + 2 \% \text{ distance})$
Distance resolution	1 ft or 0.1 m	1 ft or 0.1 m

Impulse Noise

Adjustable from 10 mV to 500 mV in 10 mV steps. The default threshold is 270 mV.

Monitors either polarity of noise on pair 3, 6.

Minimum detectable impulse width: 10 ns

Characteristic Impedance

The test tool reports an estimate of the cable's impedance at 4 m from the beginning of the link. The accuracy of the measurement is relative to a 100 Ω terminating resistance.

	Twisted Pair Cable	Coaxial Cable
Range	70 Ω - 180 Ω	35 Ω - 100 Ω
Accuracy	$\pm (5 \Omega + 5 \% \text{Nominal} - \text{Measured})$	$\pm (5 \Omega + 5 \% \text{Nominal} - \text{Measured})$
Anomaly Threshold	15 % Reflection	10 % Reflection
Resolution	1 Ω	1 Ω

LAN Traffic Monitoring

Traffic tests are run through the DSP-LIA013 Channel/Traffic adapter's Monitor jack.

Monitors 10BASE-T or 100BASE-TX Ethernet traffic. Monitors pair 3,6 for either polarity of traffic. Generates a positive polarity link pulse on pair 1,2. Generates 100BASE-TX link signals on pair 1, 2.

Auto-negotiates between 10BASE-T and 100BASE-TX. Monitors pair 3, 6 for 10BASE-T or 100BASE-TX link pulses. Generates Auto-Negotiation signals on pair 1, 2.

Hub port capabilities test determines if a hub supports the following standards:

- Auto-negotiation
- 10BASE-T
- 100BASE-TX
- 100BASE-T4
- 100BASE-TX full duplex
- 10BASE-T full duplex

Hub port locator blinks the link LED on a 10BASE-T, 10/100BASE-TX, or 100BASE-TX hub.

Tone Generator

Generates a tone that can be detected by a tone probe, such as the Fluke Networks 140 A-Bug Tone Probe. The 2 kHz tone is generated on pair 1,2.

Serial Interface

Connector: DB9 (DTE male)

Baud rate: 1200 baud to 115,200 baud

Flow control: hardware, XON/XOFF, or none

Data format: 8 data bits, 1 stop bit, no parity

Printer formats: Epson, HP LaserJet, or Text Only (ASCII text)

Test results can be uploaded to a PC and software updates can be downloaded to the test tool and remote using LinkWare software.

PC Interface Cable

Table 8-5 shows the pin connections for the PC interface cable provided with the test tool. Table 8-6 shows the pin connections for the 9-to 25-pin adapter available from Fluke Networks (part number 929187).

Table 8-5. PC Interface Cable Connections

Test Tool End DB9S (female)	Pin	Direction	PC End DB9S (female)
Data Carrier Detect	1	<----	4
Receive Data	2	<----	3
Transmit Data	3	---->	2
Data Terminal Ready (always true)	4	---->	1
Signal Ground	5	<---->	5
Not connected	6		6
Request To Send (used only with hardware flow control)	7	---->	8
Clear To Send	8	<----	7
Not connected	9		9

Table 8-6. 9-to 25-pin Adapter (available from Fluke Networks)

9-pin Connector	25-pin Connector
3	2
2	3
7	4
8	5
6	6
5	7
1	8
4	20
9	22
Shell	Shell

Power

Main unit and remote: NiMH battery pack, 7.2 V, 3500 mAh

Typical NiMH battery life: 8 to 10 hours

Charge time: 4 hours

AC adapter/charger, USA version: Linear power supply; 108 V ac to 132 V ac input; 15 V dc, 1 A output

AC adapter/charger, international version: Switching power supply; 90 V ac to 264 V ac input; 15 V dc; 1 A output

Memory backup power in main unit: Lithium battery

Typical life of lithium battery: 5 years

Environmental Requirements

Operating temperature: 32 °F to 113 °F (0 °C to 45 °C)

Storage temperature: -4 °F to +140 °F (-20 °C to +60 °C)

Pollution degree: 2

Altitude: 6562 ft (2000 m)

Avoid use outside the operating boundaries shown in Figure 8-3.

Electromagnetic Compatibility

Emissions EN61326-1, Class A.

Immunity EN61326-1

Note: Exposure to a 3 V/m Rf field, in the range of 107 MHz – 148 MHz may cause a maximum noise floor offset of +.62 dB above the calculated specification of 1.5 dB.

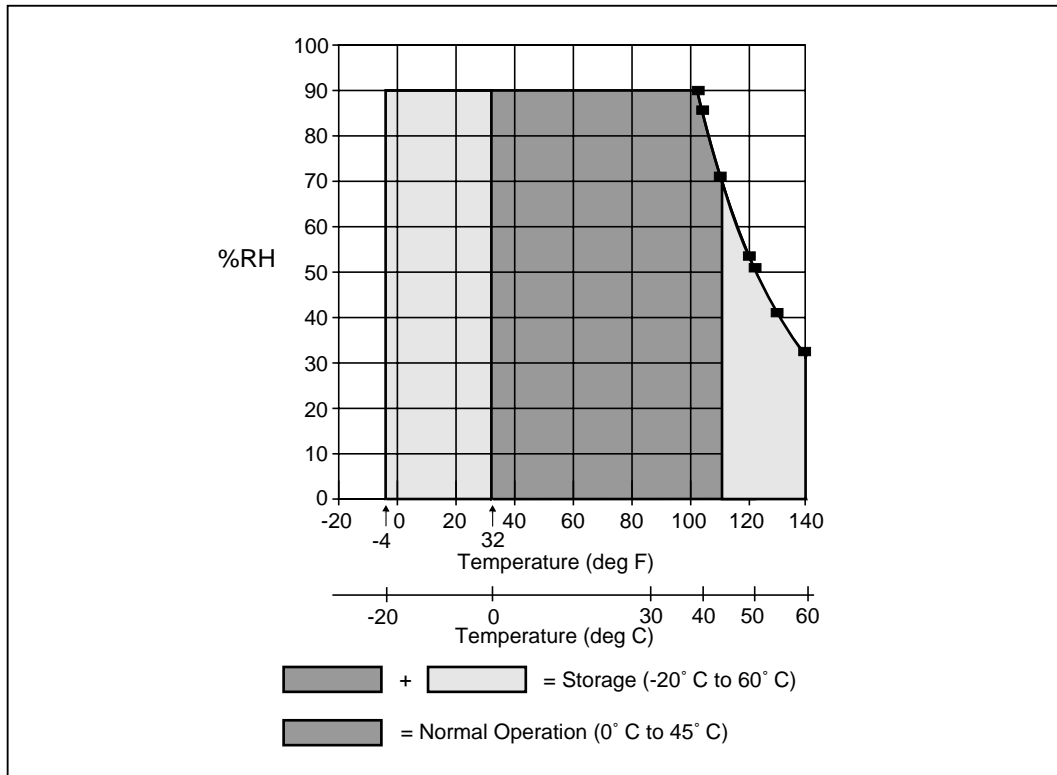



oy40f.eps

Figure 8-8. Operating Environment Specifications

Input Ratings

A DSP-4000 Series test tool and remote are designed to measure unpowered cables. The inputs are protected against continuous, current-limited telco voltages (<100 mA) and can withstand occasional overvoltages of less than 30 V rms (42 V peak, 60 V dc).

Certification and Compliance

Symbol	Description
	Conforms to relevant European Union directives.
	Listed by Canadian Standards Association.

The test tool complies with the following standards:

CSA Standards: CAN/CSA-C22.2 No. 1010.1-92 + Amendment 2: 1997 Safety Requirements for Electrical Equipment for Measurement, Control, and Laboratory Use, Part 1: General Requirements

Safety: CAN/CSA-C22.2 No. 1010.1-92 + Amendment 2: 1997; Overvoltage Category II, Pollution degree 2, 30 V. EN61010, Amendments 1, OVERVOLTAGE (Installation) CATEGORY II, Pollution Degree 2 per IEC1010-1 refers to the level of Impulse Withstand Voltage protection provided. Equipment of OVERVOLTAGE CATEGORY II is energy-consuming equipment to be supplied from the fixed installation. Examples include household, office, and laboratory appliances.

Test Results Memory for the DSP-4100/4300

The 16 MB multimedia card stores the results of at least 250 Autotests with plot data included. More results can be stored if plot data is not included. The exact number of Autotests you can store depends on the number of tests run by the selected test standard. Compatible memory cards with greater or less capacity can also be used. A 32 MB card is available as an accessory.

LinkWare software lets you upload Autotest results to a PC from a memory card installed in the test tool or a memory card reader.

1 MB Flash EPROM allows firmware and test standard updates.

The DSP-4300 includes internal memory that can store the results of at least 250 Autotests with plot data included.

Test Results Memory for the DSP-4000

512 KB nonvolatile RAM stores results from at least 500 Autotests. More storage may be available depending on the number of tests run by the selected test standard.

LinkWare software lets you upload Autotest results to a PC.

1 MB Flash EPROM allows firmware and test standard updates.

Dimensions

Main unit and remote (without LIA): 9.25" x 5" x 3"
(23.5 cm x 12.7 cm x 7.6 cm)

Weight

Main unit (without LIA): 3 lb., 4 oz (1.5 kg)

Remote (without LIA): 3 lb., 1 oz (1.4 kg)

Display

Type: Graphic bit-mapped LCD with backlight and adjustable contrast.

Size and resolution: 2.8" x 2.4" (7.1 cm x 6.1 cm), 15 lines, 30 characters per line, 240 x 200 bits.

Warranty

One year from date of purchase, including permanent link adapters. Other LIAs are warranted for 90 days (excluding tabs on RJ45 connectors). Personality modules are warranted to be free from manufacturing defects at the time of purchase.

Appendices

Appendix	Title	Page
A	Tests Supported by LIAs.....	A-1
B	Glossary	B-1

Appendix A

Tests Supported by LIAs

Table A-1 shows the test standards supported by the standard link interface adapters.

For a list of the optional link interface adapters available, visit the Fluke Networks website at www.flukenetworks.com.

Table A-1. Tests Supported by Standard Link Interface Adapters

Standard or Test	DSP-LIA011 Basic Link	DSP-LIA012 and DSP-LIA013 Channel	DSP-LIA101 Permanent Link
TIA Cat 3, 5, and 5E Basic and Permanent Link	X		X
TIA Cat 3, 5, 5E, and 6 Channel		X	
TIA Cat 6 Permanent Link			X
Class E Permanent Link			X
TIA TSB-75 MUTO Link	X	X	X
ISO11801 Channel Class C, D		X	
ISO11801 Permanent Link Class C, D	X		X
ISO Link Class C, D	X	X	X
EN 50173 Class C, D	X	X	X
Aus/NZ Class C and D Basic Link	X		X
Aus/NZ Class C and D Channel		X	
IEEE 10/100/1000BASE-T	X	X	X
TokenRing, All	X	X	X
TP-PMD	X	X	X
All coaxial standards		X ¹	
Impulse noise monitor and tone generator	X	X	X
Traffic monitoring on twisted pair cable		DSP-LIA013 only	
Hub port locator and hub port capabilities test		DSP-LIA013 only	
Optical power and loss measurements using a DSP-FOM Fiber Optic Meter ²	X	X	X
<ol style="list-style-type: none"> 1. All coaxial testing requires the RJ-45 to BNC adapter. 2. Fiber test standards are supported by optional Fiber Test Adapters. 			

Appendix B

Glossary

10BASE2

An IEEE Standard for Thin Coax Ethernet networks: 10 Mb/s transmission, baseband signaling, 185 meters per coax segment. Also known as Thinlan, Thinnet, or Cheapernet.

10BASE-T

An IEEE Standard for unshielded twisted pair Ethernet networks: 10 Mb/s transmission, baseband signaling, unshielded twisted pair cable. Maximum cabling length is 100 meters.

100BASE-TX

An IEEE Standard for twisted pair Ethernet networks: 100 Mb/s transmission; baseband signaling; two-pair, category 5 twisted pair cable. Maximum cabling length is 100 meters.

1000BASE-T

An IEEE Standard for twisted pair Ethernet networks, also known as Gigabit Ethernet: 1,000 Mb/s transmission; baseband signaling; four-pair, category 5 twisted pair cable. Maximum cabling length is 100 meters.

ACR

Attenuation to crosstalk ratio. The difference between NEXT in dB and attenuation in dB. Good cabling performance corresponds to high ACR values (in negative dB), which results when NEXT is much higher than attenuation.

Anomaly

A location on network cabling where the cabling's impedance changes abruptly.

Attenuation (Insertion Loss)

A reduction in the strength of a signal. Attenuation is usually expressed in decibels.

Auto-Negotiation

The ability of a network device to determine the capabilities of a far end device, then select settings for optimal communication.

Balun

An impedance-matching transformer used to transfer signals between coaxial and twisted pair cable. Baluns are often used to connect IBM 3270 terminals to twisted pair cable, or to connect coaxial Ethernet to UTP.

Bandwidth

A measure of the information capacity of a transmission medium. In analog communications, bandwidth is expressed in hertz (Hz) as the difference between the highest and lowest frequencies that the medium will pass without significant attenuation. In digital communications, bandwidth is measured in bits per second.

Baseband Signaling

A method of signal transmission where the entire bandwidth of the medium is used to send a single signal. The digital signal is applied, without modulation, directly to the transmission media. Ethernet is a baseband network. Compare with *broadband signaling*.

Basic Link

A network connection consisting of (1) a test equipment patch cable to a patch panel, (2) one connection at the patch panel, (3) a horizontal cable segment up to 90m (295 ft), (4) a telecommunications outlet or transition connector, and (5) a test equipment patch cable from the outlet or transition connector. Cabling test limits for a link are tighter than those for a channel because the channel limits allow for additional connections at the horizontal cross-connect and near the telecommunications outlet. The basic link is defined in TSB-67. Basic link testing, which is no longer recognized in TIA and ISO standards, is becoming less common as cabling installers adopt the newer permanent link testing standard.

Baud Rate

A measure of data transmission speed. Baud rate is the number of times per second that a signal changes states. If only one bit is encoded in each signal change, baud rate is the same as bits per second. If more than one bit is encoded in each change, the baud rate is lower than the bits per second rate.

Bit

A binary digit, which can have two values: 0 or 1. The bit is the smallest unit digital data. The word is a contraction of “binary digit”.

BNC connector

A cylindrical push-and-twist connector used on coaxial cable. BNC connectors are used on thin Ethernet cable (10BASE2).

Broadband Signaling

A method of signal transmission where the bandwidth of the medium is shared by multiple signals. The signals are separated into channels carried on different frequencies within the bandwidth. This transmission method is often used to transmit voice, data, and video signals over a single medium. Also referred to as wideband. Compare with *baseband signaling*.

Bus topology

A network in which all nodes are connected to a single cable that carries all the messages in the network.

Byte

A data unit usually made up of 8 bits. One byte typically represents one character.

Cable Pair

Two wires, usually twisted together, that form a complete circuit for signal transmission.

Capacitance

A measurement of the capacity to store electrical charge across conductive elements that are separated by an insulating material (dielectric). Undesirable capacitance that occurs between conducting wires in network cabling results in capacitive coupling, which causes crosstalk between cable pairs.

Category 3

A cabling standard for UTP voice-grade cable specified by the EIA/TIA 568 standard for use at speeds up to 10 Mbps.

Category 4

A cabling standard specified by EIA/TIA 568 for use at speeds up to 20 Mbps.

Category 5

A cabling standard specified by EIA/TIA 568 for use at speeds up to 100 Mbps.

Channel

A network connection consisting of (1) a network equipment patch cable to a horizontal cross-connect, (2) two connections at the cross-connect, (3) a horizontal cable segment up to 90 m (295 ft), (4) a transition connector near the telecommunications outlet, (5) a telecommunications outlet, and (6) a network equipment patch cable in the work area. Cabling test limits for a channel are looser than those for a basic link because the channel limits allow for the effects of two connections at the cross-connect and an extra connector near the telecommunications outlet. The channel is defined in TSB-67.

Characteristic Impedance

The total opposition (dc resistance and ac reactance) to the flow of ac current that a network cable would have if the cable were infinitely long.

Coaxial Cable

A type of transmission cable in which an inner conductor is surrounded first by an insulating layer, then by a braided, conductive sheath. The braided sheath acts as a shield that protects the inner conductor from electrical noise. Coaxial cables typically have a wide bandwidth. Two types of coaxial cable are used with Ethernet networks: Thicknet (10BASE5 standard) and Thinnet (10BASE2 standard).

Collision

The result of two stations simultaneously attempting to transmit data on a shared network transmission medium (such as Ethernet).

Crossed Pair

A wiring error in twisted pair cabling where a pair on one end of the cable is wired to a different pair in the connector on the other end of the cable.

Crosstalk

Unwanted signal transfer between adjacent cable pairs. Crosstalk occurs because electrical signals passing through a cable pair create an electromagnetic field that transmits the signal to nearby pairs.

CSV Data

Abbreviation for comma-separated variable. A list of data separated by commas. When CSV data is loaded into a spreadsheet application, the application puts each comma-separated value into a separate cell.

dB

Abbreviation for decibel. A logarithmic unit used for expressing the loss or gain of signal strength.

Download

To transfer data from a computer to a remote device.

EIA 568A

Electronic Industries Association Commercial Building Telecommunications wiring standard. See EIA/TIA 568.

EIA/TIA

The US Electronic Industries Association and Telecommunications Industries Association, which have merged.

EIA/TIA 568

The EIA/TIA Commercial Building Telecommunications wiring standard that defines generic telecommunications wiring for commercial buildings. The standard covers topics such as maximum cabling lengths, topology, installation practices, and performance specifications.

Equal Level Far End Crosstalk (ELFEXT)

The difference between the FEXT and the attenuation of the disturbed wire pair (in dB). Good cabling performance corresponds to high ELFEXT values, which result when FEXT is much higher than attenuation.

Ethernet

A local area network protocol using Carrier Sense Multiple Access with Collision Detection (CSMA/CD). Ethernet is available with four cabling alternatives: thin coaxial, standard (thick) coaxial, twisted pair, and fiber optic. This protocol uses 10 Mb/s baseband transmission and is defined by the IEEE standard 802.3.

Far-End Crosstalk (FEXT)

The amount of coupling loss (in decibels) occurring when a signal generated at one end of one cable pair is received as crosstalk at the other end of another cable pair. Higher FEXT levels correspond to better cabling performance.

Flash Memory

Computer memory that requires no power to maintain its contents, yet, unlike ROM, can be reprogrammed while installed in a system.

Foil-Screened Twisted Pair (FTP)

See *Screened Twisted Pair*.

Hardware Flow Control

A hardware method of controlling data flow between two devices. The receiving device tells the sending device to start or stop data transmission by sending control signals on a cable wire that is dedicated to flow control signals.

HDTDR™

High-definition time domain reflectometry. A technique used for finding cabling faults and measuring cabling length and characteristic impedance. A test pulse applied to the cabling is reflected by impedance discontinuities along the cabling (such as a short or an open). The cabling's characteristics are determined by timing the duration between the test pulse and the reflection and analyzing the shape of the reflected pulse.

HDTDTM

High-definition time domain crosstalk. The HDTD analyzer locates sources of NEXT along cabling. This measurement technique is patented by Fluke Networks.

Horizontal Cabling

The cabling between a telecommunications outlet and a horizontal cross-connect.

Horizontal Cross-Connect

A group of connectors, such as a patch panel or punch-down block, that allows equipment to be cross-connected with patch cords or jumpers. The horizontal cross-connect is usually located in a wiring closet.

Impedance

Opposition to the flow of ac (alternating current) signals. Impedance is caused by inductance and capacitance. Unlike resistance, impedance varies with the frequency of the applied ac signal.

Impedance Discontinuity

An abrupt change in a cabling's characteristic impedance. Impedance discontinuities can be caused by faulty connections, mismatched cable types, and untwisted sections on twisted pair cable. Also called an anomaly.

Inductance

A property of a device that tends to oppose changes in current. Inductance is an undesirable characteristic of cables because it causes signal attenuation.

Inductive Pickup

A device that emits sound when placed near a source of electromagnetic emissions. Inductive pickups are used to locate individual cables in a bundle.

Jabber

A network fault condition where a frame longer than 1518 bytes is detected. Network protocols specify a maximum packet length that one station may transmit before other stations are allowed to transmit.

Level I, Level II, Level IIE, and Level III Accuracy

Levels of performance requirements for field testing of installed, unshielded twisted pair cable links. Level I is acceptable for testing channels. Level II has tighter limits and is preferred for testing basic links. These requirements, which evolve over time, are published in TSB-67. Levels IIE and III apply to Cat 5E and the proposed Cat 6 standards, respectively.

Link Pulse

A single-bit, 100 ns test pulse that is transmitted at least every 50 ms during idle periods on 10BASE-T link segments to verify link integrity.

MUTO

Multi-user telecommunications outlet. A multiport outlet installed in the work area to support a group of users. The MUTO cabling standard addresses the need for longer sections of cable that allow more flexibility when wiring modular offices.

Near-End Crosstalk (NEXT)

The amount of coupling loss (in decibels) occurring when a signal generated at the near end of one cable pair is received as crosstalk at the near end of another cable pair. Higher NEXT levels correspond to better cabling performance.

NVP

Nominal Velocity of Propagation. The speed of a signal through a cable, expressed as a percentage of the speed of light. Typically, the speed of a signal through a cable is between 60% and 80% of the speed of light.

Packet

A group of bits in a specific format, containing a data message that is sent over a network.

Permanent Link

A network connection consisting of (1) one connection at the patch panel, (2) a horizontal cable segment up to 90m (295 ft), (3) an optional consolidation point, and (4) one connection at a telecommunications outlet. Permanent link test connections are similar to basic link connections, except that the effects of the test equipment patch cables are excluded from the test results.

Plenum Cable

Cable certified for installation in air ducts and open spaces over suspended ceilings without conduit. Plenum cable is fire resistant and does not emit toxic fumes when burned.

Propagation Delay

The time required for an electrical signal to travel the length of a cable.

PSELFEXT

Power sum ELFEXT. Power sum FEXT minus the attenuation of the disturbed pair. PSFEXT is the combined FEXT received by a cable pair from the other pairs.

PSNEXT

Power sum NEXT. The combined NEXT received by a cable pair from the other pairs.

Resistor

An electronic component that resists the flow of electrical current. Resistors are used in the *terminators* that are connected to the ends of coaxial cabling.

Return Loss (RL)

The loss of signal strength in cabling due to signal reflections. A cabling's RL value indicates how well the cabling's characteristic impedance matches its rated impedance over a range of frequencies.

Reversed Pair

A wiring error in twisted pair cabling where the pins on a cable pair are reversed between connectors on each end of the cable.

RJ45

An 8-pin modular connector used with twisted pair cable. The RJ45 connector resembles a telephone connector (RJ11).

ROM

Read-only memory. A device used for permanent storage of data or programs. A ROM does not require power to maintain its contents. Once a ROM is programmed, its contents cannot be altered.

Runt Packet

An Ethernet data packet that is shorter than the valid minimum packet length of 64 bytes. Runt packets are usually caused by a collision.

Shielded Screened Twisted Pair (SsTP)

Twisted pair cable in which each pair is wrapped in a metallic sheath, and the entire bundle is wrapped by an overall shield.

Screened Twisted Pair (ScTP)

Twisted pair cable wrapped in a metallic sheath. The sheath, which is grounded at a single location in the network, acts as a shield that protects the cable pairs from crosstalk and other sources of electrical noise.

Segment

Network cabling terminated at both ends. Segments can be joined together using repeaters or bridges.

Serial Data Transmission

The transmission of data over a single wire.

Shielded Twisted Pair

Twisted pair cable surrounded by a metallic shield that reduces electrical interference on the cable. Originally referred to shielded twisted pair IBM[®] cable with an impedance of 150 Ω .

Skin Effect

The tendency of current to flow only near the surface of a conductor. This effect becomes more pronounced at higher frequencies.

Split Pair

A wiring error in twisted pair cabling where a wire from one cable pair is twisted with a wire from another cable pair. Though the pin-to-pin connections may be correct, splitting the cable pairs causes excessive crosstalk because the electromagnetic fields around the wires cannot cancel properly.

Star Topology

A network design in which each node is connected to a central hub.

Terminator

A resistor connected to the end of a coaxial cable. The terminator, which is intended to match the characteristic impedance of the cable, eliminates signal reflections by dissipating signals in the cable.

Token Ring

A local area network that is arranged in a ring or star topology and uses token passing to control access.

TSB-67

Technical Service Bulletin 67. TSB-67 defines the requirements for field testing of installed, unshielded twisted pair cable links. It describes test configurations, required tests, pass/fail criteria, accuracy requirements, and other test parameters. TSB-67 is drafted by a Telecommunications Industry Association (TIA) task force.

Twisted Pair

A cable pair made of two wires that are twisted together to minimize crosstalk to other cable pairs. The twisting minimizes crosstalk because it causes cancellation of the electromagnetic fields generated by each wire in the twisted pair.

Unshielded Twisted Pair (UTP)

Twisted pair cable that is not shielded. UTP cable is more susceptible to crosstalk than shielded twisted pair (STP) cable.

XON/XOFF Flow Control

Transmitter ON/transmitter OFF. A software method of controlling data flow between two devices. The receiving device tells the sending device to start or stop data transmission by sending commands over the data transmission line.

Index

—\$—

- \$ (auto sequence), 2-38
- \$ (edit report identification), 2-36

—3—

- 3 dB rule, 3-21

—5—

- 568A and 568B standards, 7-3
- 568A and 568B wiring, 7-29

—A—

- AC adapter/charger, 2-4
- Accessories
 - optional, 8-6
 - standard, 1-4
- Accuracy range, 2-9
- ACR
 - ACR@Remote test, 3-16, 3-21, 3-23
 - explanation of ACR, 7-24
 - plot description, 3-20
 - results screen items, 3-19
 - test for twisted pair, 3-19
- Anomaly. See Impedance anomaly
- Asterisk
 - in test results, 2-9
 - on custom configurations, 6-5
 - on selected report, 5-5
- Attenuation
 - explanation of attenuation, 7-8
 - plot description, 3-13

- results screen items, 3-12
- test for twisted pair, 3-12
- Audible tones, enabling/disabling, 2-42
- Auto increment, 2-37
 - status, 2-40
- Auto sequence, 2-38
 - saving Autotests, 3-29
 - status, 2-40
- Automatic diagnostics, 3-7
 - display examples, 7-27
- Auto-Negotiation, 4-19
- Autotest
 - coaxial, 3-23
 - connections, 2-17, 3-23
 - descriptions of tests and results, 3-25
 - list of tests, 2-28
 - quick start, 2-16
 - report samples, 3-32
 - saving results, 3-27
 - twisted pair, 3-2
 - basic link connections, 2-12
 - channel connections, 2-13
 - connections, 3-2
 - descriptions of tests and results, 3-8
 - list of tests, 2-27
 - permanent link connections, 2-14
 - quick start, 2-10

—B—

- Backlight, 2-33
- Bail, 2-26
- Basic link
 - description, 7-5

- test connections, 2-12, 3-3
- test standard selection, 2-35

Battery

- charging, 2-4
- lithium, 8-3
- NiMH
 - removal and replacement, 8-2
 - when to replace, 8-2
- power-down timer, 2-42
- status messages, 2-44

Beeper, enabling/disabling, 2-42

—C—

Cable

- basic troubleshooting, 7-27
- configuring a custom test, 6-4
- construction, coaxial and twisted pair, 7-1
- identifying hub port connections, 4-22
- interface for PC, 8-20
- interface for printing, 5-3
- pin connections for 568 standard, 7-3

Cable ID

- auto sequence, 2-38
- changing, 3-30, 5-2
- incrementing, 2-37
- list status, 2-40
- selecting downloaded list, 2-39

Cable type

- selecting, 2-35
- selecting, quick start, 2-8

Calibration

- factory, 6-1
- NVP, 6-3
- permanent link interface adapter, 6-3
- self-calibration, 6-1

Certifications, 8-23

Channel

- description, 7-6
- test connections, 2-13, 3-4
- test standard selection, 2-35

Characteristic impedance. *See* Impedance

Compliance, 8-23

Configure custom test, 6-4

Connectors

- main unit, 2-19
- remote, 2-22

- RJ11 (telephone), 2-3

Crossed pair,wire map display, 3-9

Crossed wires,wire map display, 3-9

Crossover cable, 7-29

Custom test configuration, 6-4

—D—

Date, 2-41

Delay skew test, 3-11

- explanation of test, 7-18

Display

- adjusting contrast, 2-34

- size, 8-24

Duplicate I.D., 3-28

—E—

ELFEXT

- explanation of test, 7-12

- plot description, 3-18

- results screen items, 3-17

EMC, 8-21

—F—

False test results, 8-4

Fault anomaly threshold (twisted pair), 3-11

Fault info. *See* Automatic diagnostics

Fault Info key, 3-7

Fluke Networks, contacting, 1-1

Frequency, 350 MHz, 2-35

Front panel

- main unit, 2-19

- remote, 2-21

Full-duplex transmission, 7-26

—H—

HDTDR test

- effects of termination results, 4-10

- example plots, 7-29

- explanation of HDTDR, 7-20

- interpreting the plot, 7-23

- plot description, 4-12

- results screen items, 4-12

- twisted pair and coaxial cable, 4-9, 7-20

HDTDX analyzer

- example plots, 7-29

interpreting the plot, 7-14
 results screen items, 4-7
 running the analyzer, 4-6
 Headroom, 3-6
 Hub port capabilities, 4-26
 Hub port locator, 4-22

—|—

ID. *See* Cable ID

Impedance

- anomaly on coaxial cabling, 3-26
- anomaly on twisted pair, 3-11
- explanation of characteristic impedance, 7-10
- minimizing impedance discontinuities, 7-11
- test for coaxial cabling, 3-25
- test for twisted pair, 3-11
- warning result, 3-11

Impulse noise threshold, 4-23

Incompatible standards versions, 5-2

Incrementing cable IDs, 2-37

Inductive pickup device, 4-26

Insertion loss

- explanation of insertion loss, 7-8
- test for twisted pair, 3-12

Internal fault detected (error message), 8-4

—K—

Keys

- for moving around screens, 2-4
- functions, 2-19

—L—

Language

- selecting, quick start, 2-8

LED functions, 2-22, 2-43

Length

- test for coaxial cabling, 3-26
- test for twisted pair, 3-10
- variations between cable pairs, 3-10
- variations between measured and actual, 7-20

Length units

- selecting, 2-40

- selecting, quick start, 2-8

Link. *See* Basic link

Link interface adapter

- basic use, 2-5
- features, 2-23
- status, 2-6
- tests supported by adapters, A-2

Link performance grade, 3-6

LinkWare, 5-6

—M—

Maintenance, 8-1

Marginal test results, 2-9

Memory

- capacity, 3-27
- capacity and type, 8-23, 8-24
- full, 3-31
- maintained by lithium battery, 8-3
- space available, 3-31
- status, 2-40

Memory card

- formatting, 2-6
- inserting and removing, 2-6

Monitor

- hub port capabilities, 4-26
- monitoring impulse noise, 4-22
 - changing the noise threshold, 4-23
 - connections, 4-24
 - screen items, 4-25

Monitoring network activity, 4-19

- connections, 4-19
- screen items, 4-21

Multimedia card. *See* Memory card

—N—

New (softkey), 2-36

NEXT

- explanation of NEXT, 7-11
- minimizing NEXT, 7-17
- NEXT@Remote test results, 3-16
- plot description, 3-15
- results screen items, 3-14

Noise

- causes of electrical noise, 7-9
- changing the impulse noise threshold, 4-23

- monitoring impulse noise, 4-22
- Noise test, 2-33
- Numeric format
 - selecting, 2-41
 - selecting, quick start, 2-8
- NVP
 - determining cable NVP, 6-3
 - explanation of NVP, 7-19

—O—

- Open, wire map display, 3-9
- Overvoltage test, 2-32

—P—

- Parallel data transmission, 7-18
- PC interface cable, 8-20
- Permanent link
 - description, 7-7
 - test connections, 2-14, 3-5
- Permanent link interface adapter
 - calibration, 6-3
 - handling guidelines, 2-24
- Personality module
 - changing, 2-25
 - handling guidelines, 2-24
 - number in reports, 3-27
- Plot data, saving, 2-40
- Power line filter frequency
 - selecting, 2-34
 - selecting, quick start, 2-8
- Power sum values, explanation, 7-17
- Power-down timer, 2-42
- Printing
 - configuring the serial port, 5-3
 - connections for printing, 5-4
 - error, 5-6
 - options, 5-4
 - printer interface cable, 5-3
- Problems with the test tool, 8-4
- Propagation delay test, 3-11
 - explanation of test, 7-18
- PSACR test, 3-23
- PSELFEXT test, 3-23
- PSNEXT test, 3-23

—Q—

- Quick configuration, 2-8

—R—

- Reflection
 - causes of reflections, 7-20
 - length test result message, 3-26
- Registration, 1-2
- Remote
 - calibrating for a new remote, 6-1
 - communication error, 2-43
 - compatibility, 4-2
 - compatibility between models, 8-9
 - effects on HDTDR test, 4-10
 - features, 2-21
 - lights, messages, and audible tones, 2-43
 - when to use a remote unit, 4-2
- Renaming a report, 5-2
- Renaming saved reports, 2-36
- Replacement parts, 8-5
- Reports
 - printing reports, 5-2
 - samples, 3-32
 - viewing, deleting, and renaming reports, 5-2
- Resistance
 - test for coaxial cabling, 3-26
 - test for twisted pair, 3-10
- Reversed pairs, wire map display, 3-9
- RJ11 connector, 2-3
- RL
 - explanation of RL, 7-26
 - plot description, 3-22
 - results screen items, 3-21
 - test for twisted pair, 3-21
- Rotary switch modes, 2-26

—S—

- Safety
 - operational information, 2-1
 - standards, 8-23
- Saving Autotest results, 3-27
 - memory card, 3-27
 - quick start, 2-11
- Scanning, 4-2

- Self test
 - failure, 8-3
 - how to run, 2-32
 - Self-calibration, 6-1
 - Serial port
 - cable for printer interface, 5-3
 - configuring for printing, 5-3
 - connection for printing, 5-4
 - error, printing, 5-6
 - interface description, 8-19
 - Setup
 - configuring the test tool, 2-33
 - downloading from a PC, 2-33
 - list of settings, 2-29
 - quick setup, 2-8
 - Shield continuity test, enabling, 2-35
 - Short, wire map display, 3-9
 - Single test
 - tests for twisted pair, 4-1
 - Single Test
 - tests for coaxial cabling, 4-16
 - Smart remote. *See* Remote
 - Softkeys description, 2-19
 - Special functions, list of functions, 2-30
 - Split pair
 - explanation of split pair, 7-16
 - Split pair, wire map display, 3-9
 - Standards
 - CSA, 8-23
 - incompatible versions, 5-2
 - safety, 8-23
 - Storage, 8-2
 - Store plot data
 - selecting, quick start, 2-8
 - Strap, 2-26
 - Switch modes, 2-26
- T—**
- Talk mode, 2-15
 - Terminator
 - connection during length test, 3-26
 - connection during resistance test, 3-26
 - effects on HDTDR test, 4-10
 - Test standard
 - descriptions of standards, 2-27
 - selecting, 2-35
 - selecting, quick start, 2-8
 - Time, 2-41
 - Tone generator, 4-26
 - Top level pass* indication, 2-9
 - Traffic monitor, 4-19
 - Troubleshooting
 - finding cabling faults, 7-27
 - troubleshooting the test tool, 8-3
- U—**
- Using this manual, 1-6
- V—**
- Version
 - hardware, 2-31
 - software, 2-31
 - test standards, 2-31
 - Viewing saved reports, 5-2
 - quick start, 2-11
 - Voice communication, 2-15
- W—**
- Warning messages
 - battery voltage messages, 2-44
 - characteristic impedance warning, 3-11
 - excessive noise detected, 2-33
 - excessive voltage detected, 2-32
 - incompatible standards versions, 5-2
 - printed reports, 3-32
 - test result memory is now full, 3-31
 - test summary result, 3-11
 - the previous test results have not been saved, 3-2
 - unable to save test results, 3-31
 - warning in test results, 4-14
 - Wire map
 - description of test, 3-8
 - displays, 3-8
 - pin connections for 568 standard, 7-3
 - Worst margin
 - ELFEXT, 3-17
 - NEXT, 3-14
 - Worst margin results, 3-6
 - Worst value
 - ELFEXT, 3-17
 - NEXT, 3-14
 - Worst value results, 3-6

