



ABN 43 064 478 842

231 Osborne Avenue Clayton South, VIC 3169
PO Box 1548, Clayton South, VIC 3169
t 03 9265 7400 f 03 9558 0875
freecall 1800 680 680
www.tmgtestequipment.com.au

Test & Measurement

- > sales
- > rentals
- > calibration
- > repair
- > disposal

Complimentary Reference Material

This PDF has been made available as a complimentary service for you to assist in evaluating this model for your testing requirements.

TMG offers a wide range of test equipment solutions, from renting short to long term, buying refurbished and purchasing new. Financing options, such as Financial Rental, and Leasing are also available on application.

TMG will assist if you are unsure whether this model will suit your requirements.

Call TMG if you need to organise repair and/or calibrate your unit.

If you click on the "Click-to-Call" logo below, you can call us for FREE!

TMG Corporate Website

TMG Products Website



Click-to-Call
TMG Now

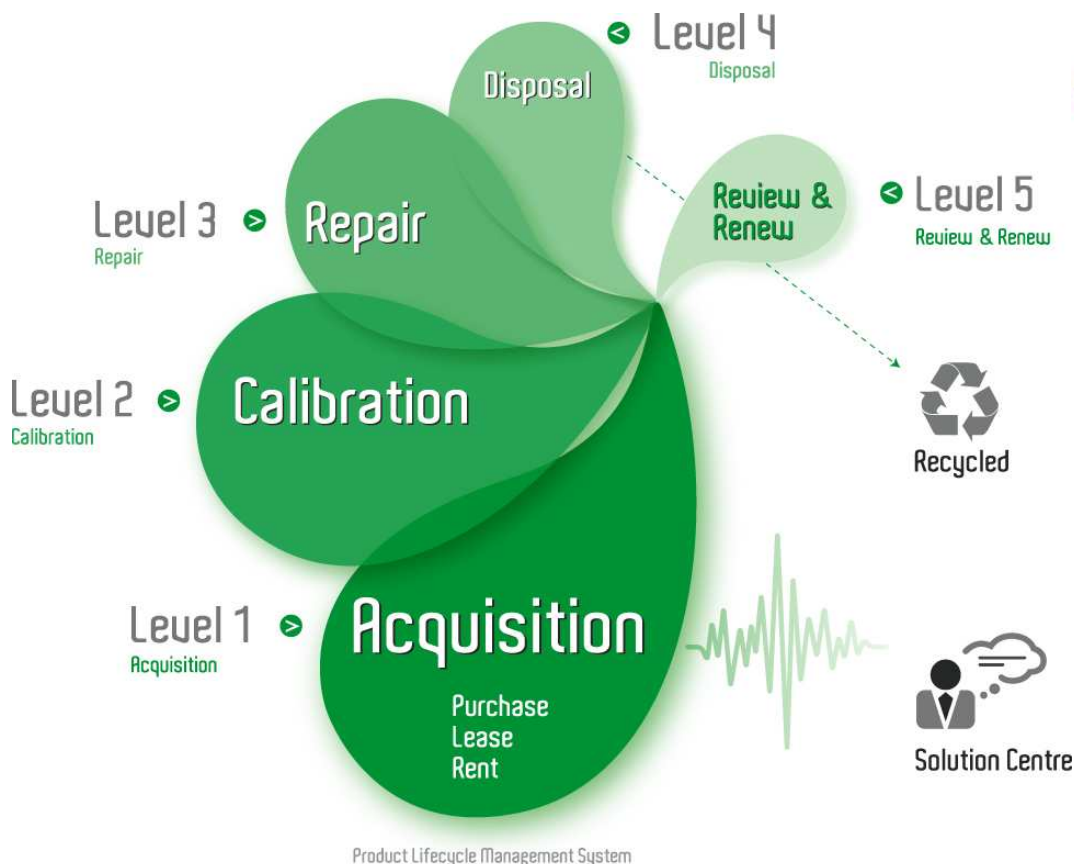

Product Lifecycle Management System

Disclaimer:

All trademarks appearing within this PDF are trademarks of their respective owners.





Version
03.00

March
2007

R&S® EFA40/43 TV Test Receiver (DVB-T)

Comprehensive analysis/demodulation/monitoring of digital terrestrial TV signals

- ◆ All DVB-T modes supported in line with ETSI EN 300744
- ◆ High-end demodulator
- ◆ High-end test receiver
- ◆ Standard test receiver
- ◆ Areas of application: production, single frequency network installation and adjustment, monitoring, coverage, research and development, service
- ◆ Comprehensive measurement and monitoring functions
- ◆ SFN option
- ◆ Simple, user-friendly operation
- ◆ Modular design – easy retrofitting of options
- ◆ IEC/IEEE bus and RS-232-C interface
- ◆ MPEG-2 decoder option

R&S®EFA – the test reference for terrestrial digital TV



In order to broadcast TV programs with optimum quality and in compliance with DVB-T standards, all components of the transmission chain must be of high-grade design. But not only does the quality of the components play a major role. It must also be ensured that all components operate in the specified ranges and that possible problems are detected early on. In this context, the DVB-T models of the R&S®EFA family of test receivers meet the demand for high-precision reception measurements. Compact in design and featuring comprehensive automatic test functionality, the instrument is ideal for R&D, modulator production testing, and in-service monitoring of TV signals.

Standard test receiver (model .40)

- ◆ Selective receiver
- ◆ Typical use in the field where adjacent channels need to be filtered
- ◆ High-end synthesizer with low phase noise
- ◆ Excellent price/performance ratio

High-end demodulator (model .43)

- ◆ Wideband input (non-selective receiver), tunable
- ◆ Typically used for transmitter testing
- ◆ Outstanding SNR, excellent intermodulation characteristics
- ◆ High-end synthesizer with extremely low phase noise

High-end test receiver (model .43 + R&S®EFA-B3 option)

- ◆ Outstanding SNR and improved intermodulation characteristics
- ◆ Rejection of image frequency and IF
- ◆ Two additional selective RF inputs (50 Ω and 75 Ω)
- ◆ Extended frequency range from 4.5 MHz to 1000 MHz

Available models and options

			Standard test receivers			High-end demodulators			High-end test receivers			Slots needed
Models			.40	.12	.78	.43	.33	.89	.43	.33	.89	
Option	Designation	Order No.	DVB-T	B/G	D/K or I	DVB-T	B/G	D/K or I	DVB-T	B/G	D/K or I	
R&S®EFA-B2	NICAM Demodulator (Standard B/G or D/K)	2067.3610.02	–	○	○	–	○	○	–	○	○	1
R&S®EFA-B2	NICAM Demodulator (Standard I)	2067.3610.04	–	–	○	–	–	○ ²⁾	–	–	○	1
R&S®EFA-B3	RF Selection	2067.3627.02	–	–	–	○	○	○	◆	◆	◆	1
R&S®EFA-B4	MPEG-2 Decoder	2067.3633.02	○	○ ¹⁾	○ ¹⁾	○	○ ¹⁾²⁾	○ ¹⁾²⁾	○	–	–	1
R&S®EFA-B6	Video Distributor	2067.3656.02	–	–	–	○ ³⁾	○	○	○ ³⁾	○	○	0
R&S®EFA-B7	Switchable Sound Trap (Standard B/G)	2067.3710.02	–	○	–	–	○	–	–	○	–	1
R&S®EFA-B10	OFDM Demodulator	2067.3740.02	✓	○ ⁷⁾	○ ⁷⁾	✓	○ ⁷⁾	○ ⁷⁾	✓	○ ⁷⁾	○ ⁷⁾	1
R&S®EFA-B11	6 MHz SAW Filter	2067.3691.00	○ ¹⁾⁴⁾⁵⁾	○ ¹⁾⁴⁾⁵⁾	○ ¹⁾⁴⁾⁵⁾	○ ¹⁾⁴⁾⁵⁾	○ ¹⁾⁴⁾⁵⁾	○ ¹⁾⁴⁾⁵⁾	○ ¹⁾⁴⁾⁵⁾	○ ¹⁾⁴⁾⁵⁾	○ ¹⁾⁴⁾⁵⁾	0
R&S®EFA-B12	7 MHz SAW Filter	2067.3591.00	○ ¹⁾⁴⁾⁵⁾	○ ¹⁾⁴⁾⁵⁾	○ ¹⁾⁴⁾⁵⁾	○ ¹⁾⁴⁾⁵⁾	○ ¹⁾⁴⁾⁵⁾	○ ¹⁾⁴⁾⁵⁾	○ ¹⁾⁴⁾⁵⁾	○ ¹⁾⁴⁾⁵⁾	○ ¹⁾⁴⁾⁵⁾	0
R&S®EFA-B13	8 MHz SAW Filter	2067.3579.02	–	○ ⁴⁾⁶⁾	○ ⁴⁾⁶⁾	–	○ ⁴⁾⁶⁾	○ ⁴⁾⁶⁾	–	○ ⁴⁾⁶⁾	○ ⁴⁾⁶⁾	0 ⁴⁾⁶⁾
R&S®EFA-K10	SFN Frequency Offset Measurement	2067.9454.02	○	○ ⁶⁾	○ ⁶⁾	○	○ ⁶⁾	○ ⁶⁾	○	○ ⁶⁾	○ ⁶⁾	0
R&S®ZZT-314	Carrying Bag for 19" units, 3 height units	1001.0523.00	○	○	○	○	○	○	○	○	○	0

Each base unit has three free slots to take up options.

✓ included in base unit ◆ must be ordered with base unit ○ available – not applicable

¹⁾ Can be retrofitted if R&S®EFA-B10 or R&S®EFA-B20 is built in.

²⁾ Cannot be retrofitted if R&S®EFA-B3 is built in.

³⁾ Requires R&S®EFA-B4.

⁴⁾ Max. 3 SAW filters.

⁵⁾ R&S®EFA models .60/.63 or R&S®EFA-B20: R&S®EFA-B11 and R&S®EFA-B12 cannot be retrofitted in parallel.

⁶⁾ Can be retrofitted if R&S®EFA-B10 is built in.

⁷⁾ Only R&S®EFA-B10 or -B20 possible (same slot needed).

The complete R&S®EFA family at a glance

Standard test receiver ◆ Model .40: digital TV, DVB-T	Standard test receivers ◆ Model .60: digital TV, DVB-C ◆ Model .12: analog TV, standard B/G ◆ Model .78: analog TV, standard D/K or I	Standard test receivers ◆ Model .50: digital TV, ATSC/8VSB ◆ Model .70: digital TV, ITU-T J.83/B ◆ Model .90: analog TV, standard M/N
High-end test receiver ◆ Model .43 incl. R&S®EFA-B3 option: digital TV, DVB-T	High-end test receivers ◆ Model .63 incl. R&S®EFA-B3 option: digital TV, DVB-C ◆ Model .33 incl. R&S®EFA-B3 option: analog TV, standard B/G ◆ Model .89 incl. R&S®EFA-B3 option: analog TV, standard D/K or I	High-end test receivers ◆ Model .53 incl. R&S®EFA-B3 option: digital TV, ATSC/8VSB ◆ Model .73 incl. R&S®EFA-B3 option: digital TV, ITU-T J.83/B ◆ Model .93 incl. R&S®EFA-B3 option: analog TV, standard M/N
High-end demodulator ◆ Model .43: digital TV, DVB-T	High-end demodulators ◆ Model .63: digital TV, DVB-C ◆ Model .33: analog TV, standard B/G ◆ Model .89: analog TV, standard D/K or I	High-end demodulators ◆ Model .53: digital TV, ATSC/8VSB ◆ Model .73: digital TV, ITU-T J.83/B ◆ Model .93: analog TV, standard M/N

See this data sheet

See data sheet PD 0758.2254.32

See data sheet PD 0757.7017.21

Common to all models

- ◆ In-depth measurement capabilities
- ◆ Simple, user-friendly operation
- ◆ Modular design – easy retrofitting of options
- ◆ General measurement functions for
 - RF input level
 - carrier frequency offset
 - bit rate offset
 - BER (before Viterbi, before and after Reed-Solomon)
- ◆ MPEG-2 transport stream output (serial or parallel)
- ◆ Alarm messages for measurement functions, internal storage
- ◆ Seven alarm-triggered relays for switching external devices
- ◆ Integrated noise generator for measurement of noise margin
- ◆ IEC/IEEE bus and RS-232-C interface

MPEG-2 decoder

(R&S®EFA-B4 option)

- ◆ Realtime analysis in line with ETSI TR 101290
- ◆ Error report
- ◆ Video and audio output

Video distributor (R&S®EFA-B6 option)⁸⁾

- ◆ Provides four video outputs (two on front and two on rear panel)

6 MHz SAW filter

(R&S®EFA-B11 option)

- ◆ Adjacent-channel rejection
- ◆ In line with US requirements

7 MHz SAW filter (R&S®EFA-B12 option)

- ◆ Designed in line with DVB-T standards
- ◆ Adjacent-channel rejection
- ◆ In line with European and Australian standards

⁸⁾ Only possible with R&S®EFA model 43 and if R&S®EFA-B4 option (MPEG-2 decoder) is fitted.

8 MHz SAW filter

(R&S®EFA-B13 option)

- ◆ Designed in line with DVB-T standards
- ◆ Adjacent-channel rejection
- ◆ In line with European standards

Analog and digital functions in one instrument

- ◆ Using the OFDM demodulator option (R&S®EFA-B10), even analog R&S®EFA TV test receivers (models .12 and .78) and demodulators (models .33 and .89) can be upgraded to dual-mode versions: analog and digital in one unit.



Fully compatible with ETSI EN 300744

Characteristics

The R&S®EFA DVB-T test receiver, fully compatible with the ETSI EN 300744 standard, receives, demodulates, decodes, and analyzes OFDM (orthogonal frequency division multiplex) signals. All key parameters for demodulating the receive signal can be selected automatically or manually:

- ◆ 6 MHz, 7 MHz or 8 MHz operating bandwidth
- ◆ 2K or 8K OFDM modulation
- ◆ QPSK, 16QAM or 64QAM constellation diagram
- ◆ 1/2, 2/3, 3/4, 5/6 or 7/8 code rate
- ◆ 1/4, 1/8, 1/16 or 1/32 guard interval
- ◆ $\alpha = 1, 2$ or 4 hierarchical demodulation

- ◆ Reed-Solomon error correction 204/188
- ◆ 6 MHz, 7 MHz or 8 MHz SAW filter bandwidth (selectable)

The operating principle of the receiver is basically the same as that of the other receivers from the R&S®EFA family, except for certain functions specified in standards.

Realtime signal analysis

The R&S®EFA's powerful digital signal processing provides fast and thorough analysis of the received DVB-T signal. Analysis is performed simultaneously with, but independently of, demodulation and decoding. The MPEG-2 transport stream is permanently available for decoding as well as for vision and sound reproduction.

Owing to its realtime analysis capability, the high number of measured values necessary for the complex calculation and display processes are made available for subsequent mathematical/statistical processing in an extremely short, as yet unequalled, time. Because of its high speed data acquisition, the R&S®EFA test receiver is the ideal choice not only in R&D but also in production environments where short measurement cycles are essential.

Features (see figures on pages 6 to 9)

The R&S®EFA-T, even the basic version, features a wide range of innovative measurement functions, allowing comprehensive, in-depth signal analysis. In addition to measuring general parameters (Fig. 1) such as bit error ratio (BER), more thorough analysis includes the following:

- ◆ I/Q constellation diagrams (Fig. 2): the number of symbols to be displayed is user-selectable, range: 1 to 999 999 symbols
- ◆ Calculation of I/Q parameters: amplitude imbalance, quadrature offset, carrier suppression, phase jitter, SNR, and MER (modulation error ratio) (Fig. 3)
- ◆ Frequency domain displays, e.g. MER(f), I|Q(f) or interferer (Figs 4, 5 and 6)
- ◆ Amplitude, phase and group-delay/frequency response displays (Fig. 7)
- ◆ Amplitude spectrum, including automatic shoulder attenuation measurement in line with ETSI TR 101290 (Fig. 8)
- ◆ Long-term monitoring of dedicated parameters through the history function (Fig. 9), monitoring time selectable from 60 s to 1000 days
- ◆ Linearity analysis from amplitude distribution histogram or CCDF (Figs 10 and 11)
- ◆ Received impulse response within and outside of the guard interval – including zoom function (Fig. 12)

- ◆ Frequency offset measurement for analysis of single frequency networks (SFN)

DVB-T: OFDM modulation for terrestrial broadcasting of digital TV signals

The DVB-T standard employs OFDM (orthogonal frequency division multiplex) modulation. This modulation is applied to the downconverter module (selective or non-selective, depending on the model) which converts the signal to a 36 MHz IF. It can then be filtered by different SAW filters (depending on the occupied bandwidth), and Gaussian noise can be internally added for margin measurements.

The IF signal is converted to the base-band using a numeric control oscillator. A fast Fourier transform (2k or 8k) translates the signal from the time domain to the frequency domain. Then, channel estimation is used to correct the signal's amplitude, phase, and delay (continuous and discrete pilots are used for this task) to eliminate most of the degradation introduced during RF transmission.

Data packets are then applied to the Viterbi convolutional decoder, data deinterleaver (outer de-interleaver), Reed-Solomon decoder and data de-randomizer (energy dispersal). Finally, the MPEG-2 interface feeds the demodulated MPEG-2 transport stream to the hardware output interface (TS SPI or TS ASI) (see Fig. below).

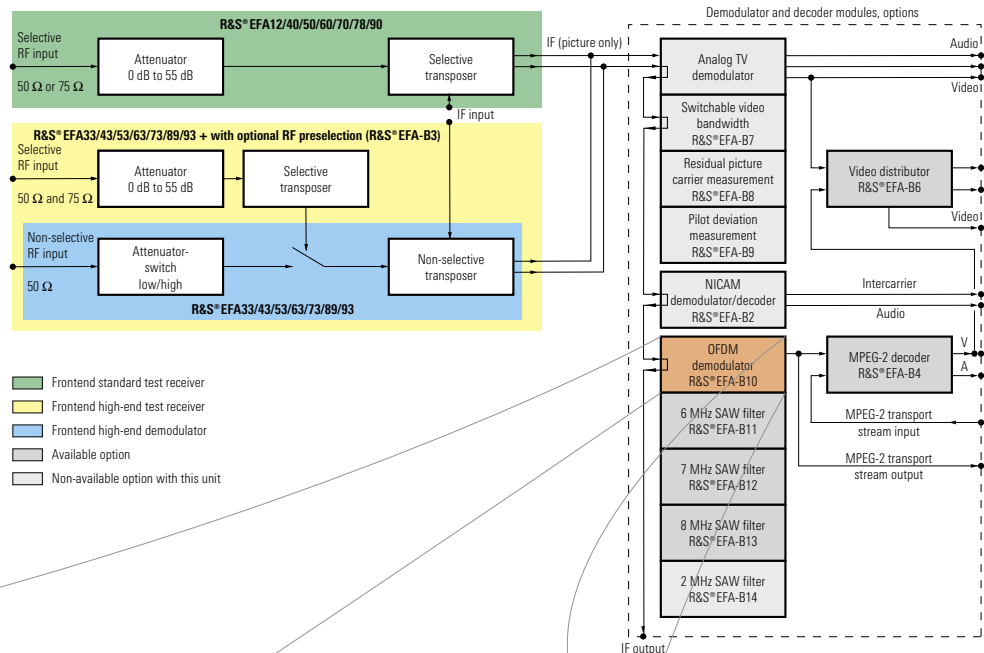

- Frontend standard test receiver
- Frontend high-end test receiver
- Frontend high-end demodulator
- Available option
- Non-available option with this unit

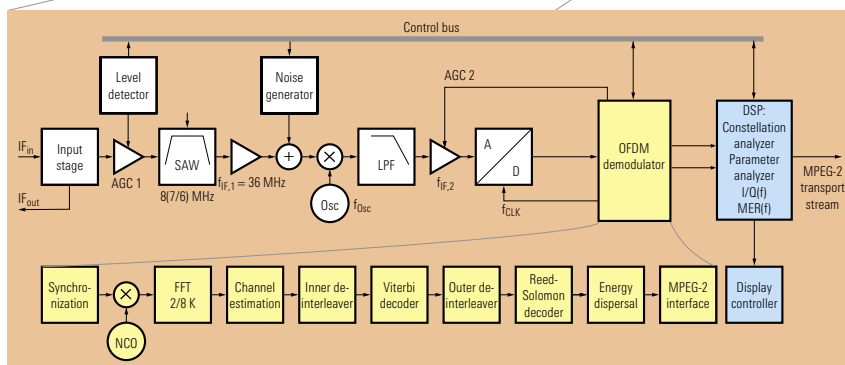

Block diagram of the R&S® EFA TV test receiver, models .40/43 (DVB-T)

DVB-T MEASURE			
SET RF (8MHz)	CHANNEL	ATTEN : 10 dB	
778.00 MHz	59	-28.8 dBm	
FREQUENCY/MER/BER:			CONSTELL DIAGRAM...
FREQUENCY OFFSET	0.220 kHz		
BITRATE OFFSET	3.6 ppm		
MER (RMS)	37.5 dB	FREQUENCY DOMAIN...	
BER BEFORE VIT	0.0E-9 (161/1K00)		
BER BEFORE RS	0.0E-9 (115/1K00)		
BER AFTER RS	0.0E-8 (117/1K00)	SPECTRUM/ TIME DOMAIN.	
OFDM/CODE RATE:			OFDM PARA- METERS...
FFT MODE	2K (TPS: 2K)		
GUARD INTERVAL	1/32 (TPS: 1/32)		
ORDER OF QAM	64 (TPS: 64)	RESET BER	
ALPHA	1 NH (TPS: 1 NH)		
CODE RATE	2/3 (TPS: 2/3)		
CELL ID	0000 (LI:21 INT:NAT)		
TPS RES (F1-F4)	30,30,30,30	ADD. NOISE OFF	
TS BIT RATE 24.12834 Mbit/s SYST OPTIM:LAB SAW:8.0MHz			

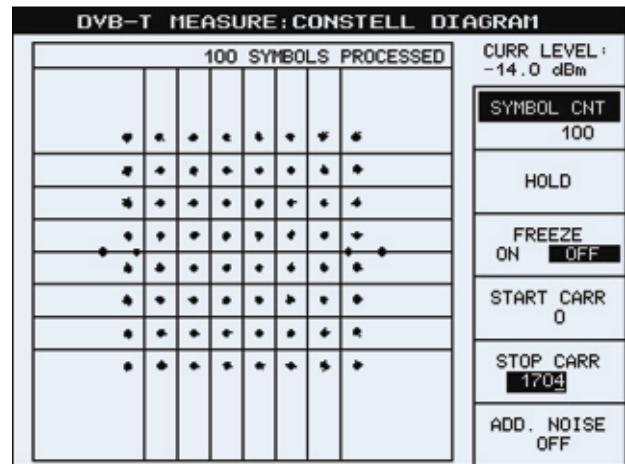

DVB-T MEASURE: OFDM PARAMETERS			
SET RF (8MHz)		ATTEN : HIGH	
474.00 MHz		-35.7 dBm	
PARAMETERS: CENTR CARR ONLY			CONSTELL DIAGRAM...
MODULATOR:			FREQUENCY DOMAIN...
I/Q AMPL IMBALANCE	-0.13 %		
I/Q QUADRATURE ERROR	-0.04 °		
CARRIER SUPPRESSION	35.1 dB	SPECTRUM/ TIME DOMAIN.	
PHASE	+47 °		
TRANSMISSION:			START CARR 852
PHASE JITTER (RMS)	0.21 °		
SIGNAL/NOISE RATIO	38.9 dB	STOP CARR 852	
SUMMARY:			ADD. NOISE OFF
MOD ERR RATIO (RMS)	31.0 dB		
MOD ERR RATIO (MIN)	23.3 dB		
MOD ERR RATIO (RMS)	2.8 %		
MOD ERR RATIO (MAX)	6.8 %		
AVERAGE: 100 %			

Fig. 1: Main measurement menu

All parameters for the demodulated DVB-T channel are displayed on a single screen and can be checked at a glance:

- ◆ The three BERs (bit error ratio) – before Viterbi decoder, before and after Reed-Solomon decoder – provide a fast quality overview of the demodulated signal
- ◆ The frequency offset of the central carrier
- ◆ Whether the transmitted TPS pilots are correct (compared with the internal demodulator settings)
- ◆ TPS information for DVB-H

Hint: The internal noise generator can be activated to perform END (equivalent noise degradation) measurements or noise margin measurements which are based on the BER measurement.

Fig. 2: Constellation diagram

The constellation diagram is always the best way to represent digital modulation. It is also the best visual tool for interpreting measurement results, for example from carrier suppression or I/Q amplitude imbalance measurements. For in-depth analysis, it is possible to adjust the displayed number of symbols (100 symbols are shown in this example). If required, the R&S®EFA can set the number automatically to obtain an optimal refresh rate.

Fig. 3: OFDM parameters

All OFDM parameters are calculated from the constellation diagram for the selected carriers. It is then very easy to measure, for example, the suppression of the RF central carrier of a modulator in 2K mode (carrier 852 – discrete pilot) even in 8K mode (carrier 3408 – continuous pilot).

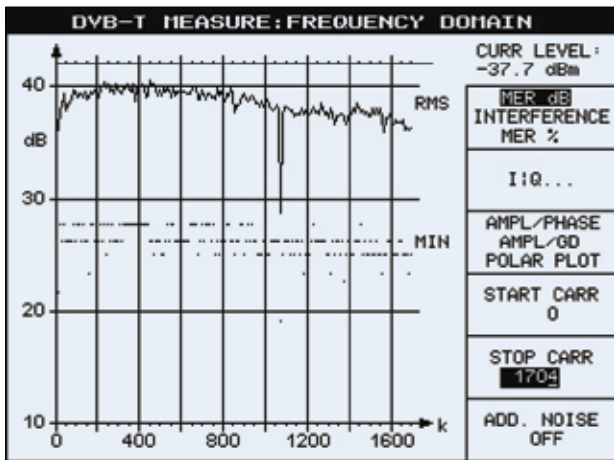

4

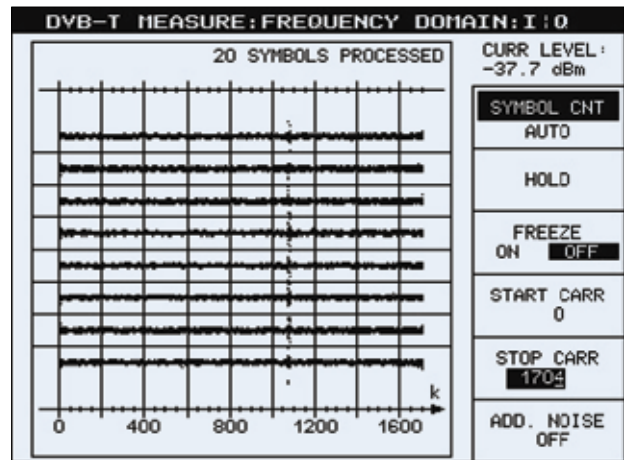

5

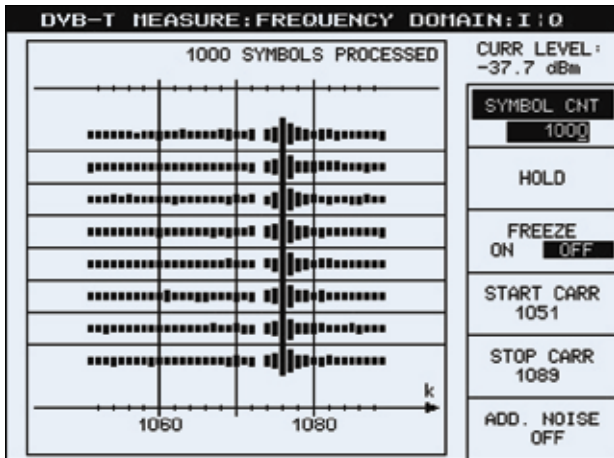

6

Fig. 4: MER as a function of frequency

MER as a function of the frequency is one of the most powerful measurements that the R&S®EFA can perform. It displays the MER for every QAM modulated carrier of the OFDM signal. At a glance, you can measure the overall quality of the transmitter under test.

With START CARR and STOP CARR, you can quickly locate any impaired QAM carrier in the OFDM signal. Co-channel interference can also be measured and displayed when an interference measurement is performed (interference-to-carrier measurement).

Fig. 5: I/Q versus frequency

This diagram shows symbols versus frequency. In other words, the quadrature (Q) and the in-phase (I + 90°) information of the constellation diagram are displayed for a complete symbol.

A glance at the constellation diagram immediately shows any errors or degradations.

Fig. 6: I/Q versus frequency (zoom)

Effects of interest can be located more precisely by varying the number of symbols and carriers that are displayed. Any impairment (carrier 1076 is clearly marked on display) can then be localized quickly and easily.

The same method can be used for all frequency domain measurements – for example MER versus frequency or the polar plot.

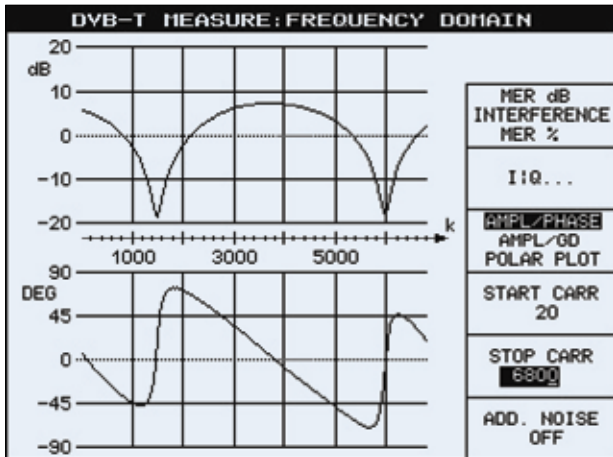

7

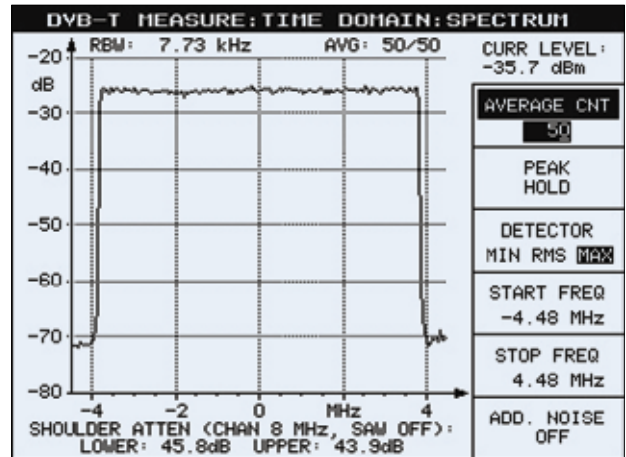

8

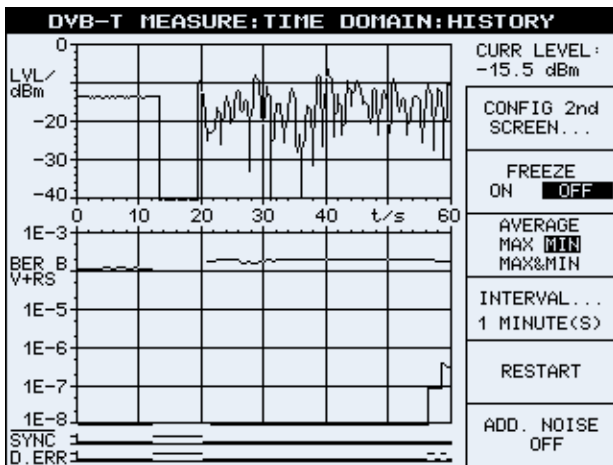

9

Fig. 7: Channel estimation

In the OFDM demodulation chain, channel estimation compensates for frequency, phase, and delay degradations that have been introduced during DVB-T transmission. It is then easy for the R&S®EFA to output the amplitude response, the phase response, and the group delay, displaying the channel estimation coefficients versus frequency.

The polar plot may also help to interpret very fast echoes (difficult to visualize with impulse response measurements).

Fig. 8: Spectrum analysis

Owing to this integrated feature, you will not need a separate spectrum analyzer anymore. All basic spectrum analyzer functions are provided, for example start/stop frequency (or center/span), as well as several detection and averaging modes.

The automatic shoulder attenuation measurement (strictly in line with ETR 290), makes checking the performance of any DVB-T transmitter very easy.

Fig. 9: History function

This measurement is just what is required for long-term DVB-T transmitter monitoring. Most key parameters (level, MER/dB, MER/%, BER, and synchronization information) are therefore displayed in graphical form. This mode can also display all values numerically (average, max, min, current). BER and level measurements run continuously and are independent of other measurements.

Hint: Results are easy to read from a remote location.

10

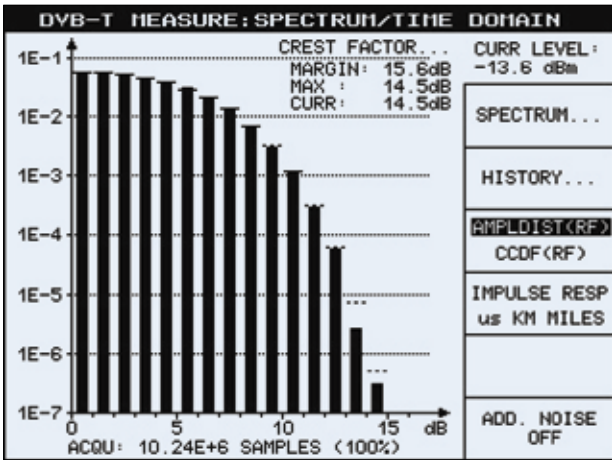

11

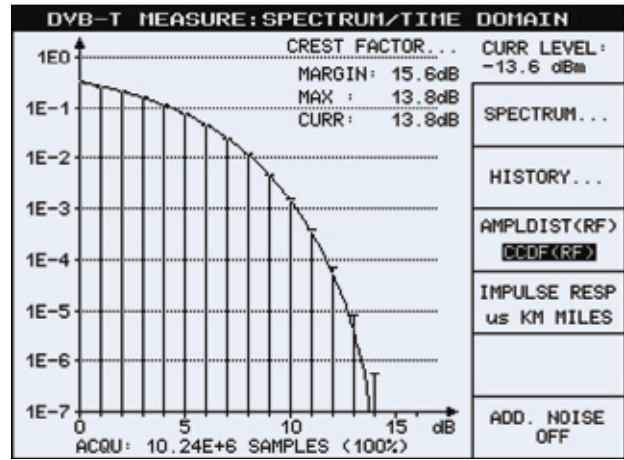

12

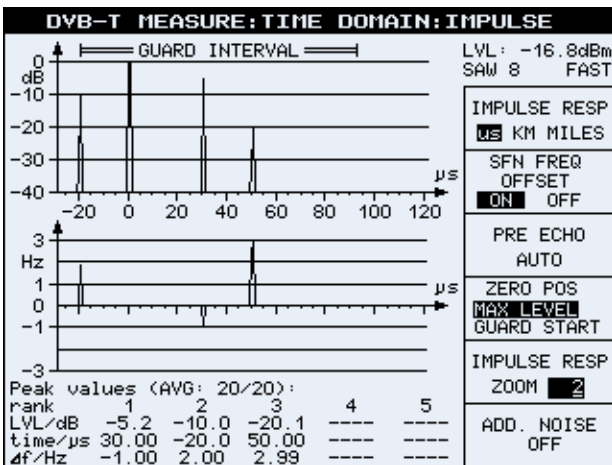

13

DVB-T ALARM: CONFIG: RELAYS			
SET RF	CHANNEL	ATTEN	LOW+P
394.00 MHz	≤32	-53.4 dBm	
ALARM		RELAYS ASSIGNMENT	
SUM ALARM	NONE	1	2 3 4 5 6 7
LEVEL	NONE	1	2 3 4 5 6 7
MPEG TS SYNC	NONE	1	2 3 4 5 6 7
MER dB	NONE	1	2 3 4 5 6 7
EVM/MER %	NONE	1	2 3 4 5 6 7
BER BEFORE RS	NONE	1	2 3 4 5 6 7
MPEG DATA ERROR	NONE	1	2 3 4 5 6 7

Fig 10: Amplitude distribution function
 The measurement function for displaying the amplitude distribution or the CCDF (complementary cumulative distribution function) is used to detect nonlinear distortions. The frequency distribution of the DVB-T signal is divided into several 1 dB windows to determine the amplitude distribution. Information on the crest factor is obtained from the frequency distribution and displayed in the upper right-hand corner of the graph.

The ideal frequencies are displayed as short, horizontal lines at 1 dB intervals (reference values) so that the amplitude distribution of the applied signal can be compared with that of an ideal DVB-T signal. Any deviation from the ideal distribution is then identified by the deviations of the column heights and the value of the crest factor, for example due to clipping in the transmitter output stage.

To suit the application, the x-axis unit and scale can be changed, for example from μs to km or even miles.

The reference values are marked by short horizontal lines.

Fig 11: Complementary cumulative distribution function (CCDF)
 In contrast to the amplitude distribution, each trace point indicates how often a certain voltage level is attained or exceeded.

Fig 12: Impulse response
 The impulse response measurement (within the guard interval) is very useful. Especially so for single frequency network (SFN) adjustment. The measurement lets you visualize and measure (numeric values) the main DVB-T signal (0 dB, reference), echoes, and pre-echoes. The zoom function lets you visualize fast echoes that may occur in urban areas (reflections from buildings).

The unique R&S®EFA-K10 SFN option adds frequency offset measurement capability, referenced to the main impulse, to the impulse response function. The accuracy is typ. <0.3 Hz. This enables you to determine at a glance whether the SFN conditions are met, without having to connect the R&S®EFA to an external GPS reference.

Fig. 13: Configuration of alarm relays
 Alarms can be signaled via seven integrated relays. An assignment table is available for configuring the alarm relays.

Typical applications

Production testing on modulators and transmitters (calibration and test)

The R&S®EFA's analysis capabilities make it possible to pinpoint problems such as interferers and inadequate carrier suppression: The constellation diagram shows the symbols, but only if a single carrier is affected – the difficulty is localization. This is exactly what the I/Q measurement function does: Symbols are displayed as a function of carriers (frequency domain) to locate the problem in the spectrum display. Once the interferer is localized, the constellation display can be used for further evaluation. This approach can also be used with the MER-vs-frequency measurement function.



Transmitter installation and adjustment of single frequency networks (SFN)

The time domain analysis extends the R&S®EFA's range of applications to SFN installation and adjustment – an area where spectrum and impulse-response analysis are very useful. The impulse response function makes it possible to visualize the delay between two transmitters at a reception point. This measurement function can be used to optimize the delay between the transmitters. The zoom function makes it possible to see fast echoes, for example direct reflections from a building, mountain, etc. In order to check whether all SFN transmitters operate on exactly the same frequency, the R&S®EFA can furthermore be equipped with the R&S®EFA-K10 option (see page 9). Together with the impulse response function, this option makes it possible to monitor all parameters that are important for SFN operation and thus ensures correct operation.

Coverage measurements on terrestrial signals (see photo above)

To allow measurements to be performed under even the worst reception conditions, a single keystroke will optimize the OFDM demodulator for mobile reception (where a lot of impairments affect transmission quality) or stationary reception. The algorithms for speed and channel equalization are optimized, as is internal level control.

Monitoring TV transmitters and transposers

The R&S®EFA is the perfect solution for DVB-T signal monitoring. An alarm is triggered if one of the selected parameters exceeds the threshold that has been set. The incident level, OFDM synchronization, MER (modulation error ratio), BER (before Viterbi and before Reed-Solomon decoders), and the MPEG-2 transport stream output can be checked in realtime independent of other measurements and decoding. If an error occurs, a 1000-row register is available to record the date, time, and designation of the event. The R&S®EFA-B4 MPEG-2 decoder option extends monitoring capabilities. Realtime measurements in line with test specifications for DVB systems (ETSI TR 101290 – priorities 1, 2, and 3) can be performed and make the R&S®EFA a complete DVB-T monitoring system.

! most important measurement ✓ required measurement *The table below summarizes the measurements required for the various DVB-T applications*

DVB-T OFDM application	Level	BER	MER	SNR	Carrier suppression	Quadrature error	Amplitude imbalance	Phase jitter	Constellation diagram	MER(f)	I/Q(f)	Spectrum/shoulder attenuation	Amplitude(f)/phase(f)/group	Amplitude distribution CCDF	Impulse response	History	Frequency offset
Production of modulators and transmitters	✓	✓	✓	✓	✓	✓	✓	✓	✓	✓	✓	✓	✓	!	✓	✓	
Transmitter installation and SFN adjustments	✓	✓	✓						✓	✓	✓	✓			!	✓	!
Coverage measurement of terrestrial signals	✓	!	✓						✓			✓			✓	✓	✓
Monitoring of TV transmitters and transposers	✓	✓	✓						✓				✓		✓	!	✓
Research & development	✓	✓	✓	✓	✓	✓	✓	✓	✓	!	✓	✓	✓	✓	✓	✓	✓
Service	✓	✓	✓	✓	✓	✓	✓	✓	!	✓	✓	✓	✓	✓		✓	

DVB-T MEASURE: CONSTELL DIAGRAM

100 SYMBOLS PROCESSED

CURR LE
-14.0

SYMBOL

HOL

FREE
ON

START



Specifications

Realtime measurement functions in line with test specifications for DVB systems (ETSI TR 101290)

Model-specific characteristics

	DVB-T standard test receiver (model .40)	DVB-T high-end test receiver (model .43) with R&S® EFA-B3 option	DVB-T high-end demodulator (model .43)
RF input	selective		non-selective
Connector	50 Ω or 75 Ω, BNC or N female, front or rear panel (see configuration sheet ³⁾)	50 Ω, N female, rear panel, and 75 Ω, BNC female, rear panel	50 Ω, N female, rear panel
Return loss	≥14 dB in channel with 50 Ω connector and input attenuation ≥10 dB ≥12 dB in channel with 75 Ω connector and input attenuation ≥10 dB	≥17 dB (typ. >20 dB) in channel with 50 Ω connector ≥14 dB (typ. >17 dB) in channel with 75 Ω connector	≥30 dB
Frequency range	48 MHz to 862 MHz	4.5 MHz to 1000 MHz ¹⁾	45 MHz to 1000 MHz
Level range (lower values: QPSK only ¹²⁾)	-72 dBm to +20 dBm (with LOW NOISE, preamplifier = OFF) -82 dBm to -47 dBm (with LOW NOISE, preamplifier = ON) -88 dBm to -47 dBm (with LOW NOISE, preamplifier = ON and HIGH ADJ CHAN POWER = ON)	-85 dBm to +14 dBm (low noise) -80 dBm to +20 dBm (normal) -80 dBm to +20 dBm (low distortion) -90 dBm to -10 dBm (low noise and HIGH ADJ CHAN POWER = ON)	-50 dBm to +20 dBm
Noise figure (50 Ω input, RF ≥47.15 MHz)	typ. 12 dB (low noise) typ. 7 dB (preamplifier and low noise)	typ. 7 dB (low noise) typ. 9 dB (normal) typ. 11 dB (low distortion)	
Image frequency rejection	≥70 dB (VHF) and ≥50 dB (UHF)	100 dB	
IF rejection		100 dB	
Local oscillator Resolution	1 Hz		
Frequency error	≤2 × 10 ⁻⁶		
OFDM demodulator characteristics			
Inherent MER ²⁾	≥38 dB	≥40 dB	≥42 dB
Inherent SNR ²⁾	≥39 dB	≥41 dB	≥43 dB

RF selection for demodulator – R&S® EFA-B3 option

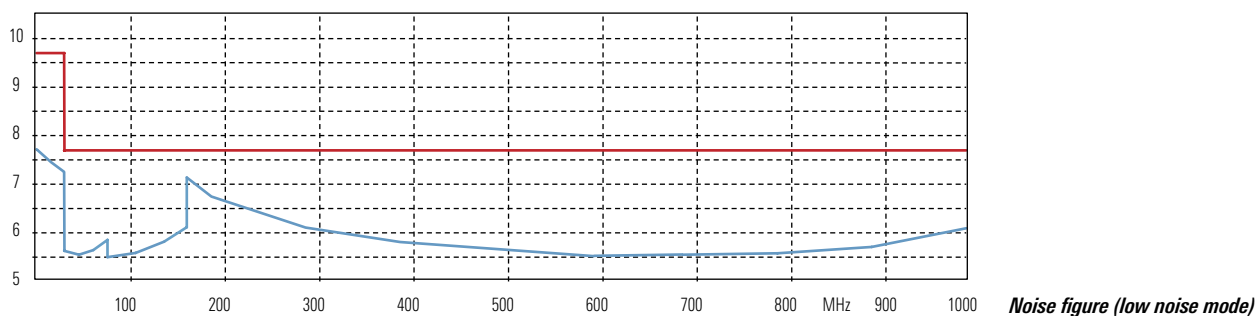

Common characteristics

IF input	50 Ω, BNC female, rear panel, 36 MHz
Return loss in channel	≥30 dB
Level range	-30 dBm to -5 dBm
IF output	50 Ω, BNC female, rear panel, 36 MHz
Return loss in channel	≥20 dB
Level, regulated	-17 dBm

¹⁾ At low input frequencies such as 4.57 MHz: additional tilt (typ. 0.7 dB pp), minimum input level: -30 dBm, SAW filter ON.

²⁾ Valid for instruments delivered as of January 2001.

³⁾ Available from your local representative or from the Rohde & Schwarz website, search term: EFA.

10 MHz reference input Level range	50 Ω , BNC female, rear panel -20 dBm to +16 dBm
10 MHz reference output Level	50 Ω , BNC female, rear panel typ. +11 dBm
OFDM characteristics	
Bandwidth operation	6 MHz, 7 MHz and 8 MHz, switchable
SAW filters	6 MHz, 7 MHz, 8 MHz or OFF
Bit rate clock inaccuracy	<10 ppm (typ. < 3 ppm)
FFT mode	2K or 8K carriers
Constellation	QPSK, 16QAM, 64QAM
Guard interval	1/4, 1/8, 1/16, 1/32
Code rate	1/2, 2/3, 3/4, 5/6, 7/8
Hierarchical modulation	OFF, $\alpha = 1$, $\alpha = 2$, $\alpha = 4$
Equivalent noise degradation (END) at 64QAM; R 2/3	≤ 1.5 dB
Channel correction	self-adapting
I/Q inversion	automatic, with indication
BER processing	before Viterbi decoder, before and after Reed-Solomon decoder
Measurements Level, frequency offset, bit rate offset, TS bit rate/BER (bit error ratio) before Viterbi decoder, before and after Reed-Solomon decoder/MER (modulation error ratio) in dB and %/SNR (signal-to-noise ratio), carrier suppression (2K and 8K)/quadrature error, amplitude imbalance, phase jitter/shoulder attenuation (upper/lower) in line with ETSI TR 101290/crest factor	
Graphic displays Constellation diagram, start/stop frequencies and number of symbols selectable/MER(f) in dB: RMS and max. values, start/stop frequencies selectable/MER(f) in %: RMS and min. values, start/stop frequencies selectable/Interference(f) in dB: RMS and max. values, start/stop frequencies selectable/I/Q(f), start/stop frequencies and number of symbols selectable/frequency spectrum, start/stop frequencies selectable/amplitude(f), start/stop frequencies selectable/phase(f), start/stop frequencies selectable/group delay(f), start/stop frequencies selectable/polar plot, start/stop frequencies selectable/amplitude distribution (RF)/CCDF (RF)/impulse response (t) with zoom (max. zoom = 20) SFN frequency offset (R&S®EFA-K10)/history for level (all level units available), MER (dB and %), BER before Viterbi, BER before Reed-Solomon decoder, all measurements: MAX and MIN and AVERAGE and MAXMIN detectors running in parallel	

DVB-H measurements with R&S®EFA40/43 or with R&S®EFA-B10 option

	2K, native interleaving	2K, in-depth interleaving ⁴⁾	4K mode	8K, native, in-depth interleaving	
Level	yes		yes	yes	
Constellation					
OFDM parameters					
MER/EVM					
MER(f)			yes		-
I/Q(f)					
Impulse response					
BER before Viterbi			-		
BER before Reed-Solomon					
BER after Reed-Solomon					
Spectrum/CCDF					yes
DVB-H signaling (TPS)			yes		-
TPS length indicator					

⁴⁾ "FEC Sync not required" must be set.

Protection ratio for DVB-T interfered with by analog TV in the lower adjacent channel (n-1), 64QAM, R 2/3, 8 MHz, QEF, LOW DISTORTION and HIGH ADJ CHAN, POWER = ON	typ. 44 dB
Protection ratio for DVB-T interfered with by analog TV in the upper adjacent channel (n+1), 64QAM, R 2/3, 8 MHz, QEF, LOW DISTORTION and HIGH ADJ CHAN, POWER = ON	typ. 42 dB
MPEG-2 TS parallel output	synchronous LVDS (188 byte, 204 byte, TS SPI), 100 Ω
MPEG-2 TS ASI output	asynchronous serial MPEG-2 transport stream (TS ASI); 75 Ω
SER DATA output	serial data stream ahead of Viterbi decoder; 75 Ω
SER CLOCK output	clock output for SER DATA; 75 Ω
Alarm messages	level, synchronization, BER before Viterbi, BER before and after Reed-Solomon, data transmission error
Storage	with date and time, up to 1000 lines
Memory for instrument setup storage	0 to 4

Test parameters	Range	Resolution	Error
Level	depending on model, see above	0.1 dB	<3 dB, typ. <1 dB
MER dB (modulation error ratio in dB)	18 dB to 30 dB 30 dB to 35 dB	0.1 dB 0.1 dB	≤ 1 dB ≤ 1.2 dB
MER % (modulation error ratio in %)	1.9% to 3.2% 3.2% to 12.5%	0.01% 0.01%	$\leq 14\%$ of actual value $\leq 12\%$ of actual value
SNR (signal/noise ratio)	18 dB to 30 dB 30 dB to 35 dB	0.1 dB 0.1 dB	≤ 0.7 dB ≤ 1.0 dB
I/Q amplitude imbalance	0.00% to 5.00%	0.01%	$\leq 0.05\%$
I/Q quadrature error	0.00° to 5.00°	0.01°	$\leq 0.05^\circ$
Carrier suppression	-5 dB to +25 dB +25 dB to +30 dB	0.1 dB 0.1 dB	≤ 1 dB ≤ 3 dB
Frequency offset 10 MHz reference, internal 10 MHz reference, external	± 300 kHz ± 300 kHz	1 Hz 1 Hz	≤ 280 Hz + 2 ppm \times RF ≤ 1 Hz
Bit rate offset 10 MHz reference, internal 10 MHz reference, external	± 40 ppm ± 40 ppm	0.1 ppm 0.1 ppm	≤ 10 ppm, typ. ≤ 3 ppm ≤ 0.5 ppm
MPEG-2 TS bit rate	up to 51 600 Mbit/s	1 bit/s	<35 bit/s
BER before Viterbi	1.0×10^{-2} to 0.1×10^{-15}	$0.1 \times 10^{-\text{exponent}}$	–
BER before Reed-Solomon	1.0×10^{-3} to 0.1×10^{-15}	$0.1 \times 10^{-\text{exponent}}$	–
BER after Reed-Solomon	1.0×10^{-5} to 0.1×10^{-14}	$0.1 \times 10^{-\text{exponent}}$	–
Crest factor	0.0 dB to 15.0 dB	0.1 dB	0.1 dB
Echo values (max. = 5 echoes, remote: 25 echoes)	0.0 dB to -40.0 dB	0.1 dB, 10 ns	0.5 dB, 30 ns
SFN frequency offset (R&S®EFA-K10 option)	± 5 kHz	0.01 Hz	≤ 0.3 Hz

MPEG-2 decoder – R&S®EFA-B4 option

Realtime measurement functions: simultaneous monitoring of all signals in transport stream

Realtime measurement functions in line with test specifications for DVB systems (ETSI TR 101290): priorities 1, 2, and 3

Signal format Transport stream Data rate of transport stream Length of data packets	in line with ISO/IEC 1-13818 up to 54 Mbit/s 188/204 bytes, automatic switchover
Signal input Internal: from DVB demodulator External: asynchronous serial MPEG-2 transport stream, 270 Mbit/s (TS ASI)	BNC connector on rear panel, 200 mV to 1 V V_{pp} , 75 Ω
Video signal output CCVS (PAL, SECAM, NTSC) Video serial digital (ITU-R 601), 270 Mbit/s	BNC connector on rear panel, 1 V V_{pp} , $\pm 1\%$, 75 Ω BNC connector on rear panel, 800 mV V_{pp} , 75 Ω

Audio	
Connectors	Lemo Triax female, paired; on front panel: unbalanced, on rear panel: balanced, floating
Impedance	<25 Ω
Signals	mono, left/right, sound 1/ sound 2
Level (full scale)	+6 dBm \pm 0.2 dB into 600 Ω
Frequency response (40 Hz to 15 kHz)	\pm 0.5 dB relative to 1 kHz
S/N ratio	>70 dB, unweighted
THD	>70 dB

Video distributor – R&S®EFA-B6 option

Video output	2 \times BNC female on front panel; 2 \times BNC female on rear panel
Impedance	75 Ω
Return loss (0 Hz to 6 MHz)	\geq 26 dB
Level inaccuracy	\leq 2%
DC offset of video signal, MPEG-2 decoder mode, black level	0 V
Decoupling of outputs (level variation at terminated output when switching the other outputs between short circuit and open circuit)	\leq 1%

6 MHz SAW filter – R&S®EFA-B11 option

Ripple in band	0.4 dB pp
Rejection of adjacent channels	>50 dB ($>\pm$ 3.8 MHz) >85 dB ($>\pm$ 5.3 MHz) with HIGH ADJ CHANNEL POWER = ON

7 MHz SAW filter – R&S®EFA-B12 option

Ripple in band	0.7 dB pp
Rejection of adjacent channels	>55 dB ($>\pm$ 4.0 MHz) >90 dB ($>\pm$ 5.3 MHz) with HIGH ADJ CHANNEL POWER = ON

8 MHz SAW filter – R&S®EFA-B13 option

Ripple in band	0.8 dB pp
Rejection of adjacent channels	>55 dB ($>\pm$ 4.4 MHz) >90 dB ($>\pm$ 5.3 MHz) with HIGH ADJ CHANNEL POWER = ON

Mobile reception

When the R&S®EFA40/43 is set to MOBILE mode (SPEC FUNC: SYSTEM OPTIMIZATION), mobile reception is optimized. The following measurements provide current information about the performance of the R&S®EFA40/43. These measurement results are valid for firmware 4.60.

2K mode

In the 2K mode, a faded signal simulating a typical urban (TU6) reception environment is fed to the R&S®EFA. The signal includes 6 paths with wide delay dispersion and relatively strong power (see ETSI TR 101290, Annex K.3).

Tap number	Delay (μ s)	Power (dB)	Doppler spectrum
1	0.0	-3	Rayleigh
2	0.2	0	
3	0.5	-2	
4	1.6	-6	
5	2.3	-8	
6	5.0	-10	

The R&S®EFA was set up as follows:

- Channel bandwidth = 8 MHz
- System optimization = mobile
- SAW filter bandwidth = 8 MHz

The Doppler frequency (which is a function of speed and radio frequency) was increased until the BER before the Reed-Solomon decoder was $2.0E-4$ or until one MPEG data error occurred in 1 minute. The following table indicates the Doppler frequency in Hz.

Order of QAM	Code rate	Guard = 1/4	Guard = 1/8	Guard = 1/16	Guard = 1/32
QPSK	1/2	58	61	60	67
	2/3	40	42	44	47
	3/4	33	35	36	39
	5/6	28	26	27	31
	7/8	24	22	23	25
16QAM	1/2	30	26	32	35
	2/3	21	25	24	24
	3/4	14	9	18	16
	5/6	0.2	0.5	7	5
	7/8	0.4	0.2	0.3	0.3
64QAM	1/2	5	4	1	1
	2/3	0.2	0.2	0	0
	3/4	0.2	0	0	0
	5/6	0	0	0	0
	7/8	0	0	0	0

8K mode

In the 8K mode, a 0 dB echo profile in line with ETSI TR 101290, Annex K.3, was fed to the R&S®EFA:

Tap number	Delay (μs)	Power (dB)	Doppler spectrum	Frequency ratio
1	0.0	0	pure Doppler	-1
2	½ T _G			+1

The R&S®EFA was set up as follows:

- Channel bandwidth = 8 MHz
- System optimization = mobile
- SAW filter bandwidth = 8 MHz

The Doppler frequency (which is a function of speed and radio frequency) was increased until the BER before the Reed-Solomon decoder was 2.0E-4 or until one MPEG data error occurred in 1 minute. The following table indicates the Doppler frequency in Hz.

Order of QAM	Code rate	Guard = 1/4	Guard = 1/8	Guard = 1/16	Guard = 1/32
QPSK	1/2	23.1	21.0	23.3	24.5
	2/3	7.2	15.5	17.0	17.0
	3/4	0.5	10.9	12.2	11.8
	5/6	0	5.0	7.2	7.6
	7/8	0	0	4.0	4.1
16QAM	1/2	10.2	5.1	8.8	8.8
	2/3	0.2	3.4	5.7	5.9
	3/4	0	2.3	4.8	5.1
	5/6	0	0.1	3.0	3.4
	7/8	0	0	1.0	2.3
64QAM	1/2	0	1.8	3.6	3.7
	2/3		0	1.8	2.0
	3/4		0	1.3	1.6
	5/6		0	0	0.8
	7/8		0	0	0

General data

Display	monochrome LCD (320 × 240), backlit
Interfaces	IEC 625-2/IEEE 488 bus, RS-232-C, printer (Centronics)
Temperature range	in line with IEC 68-2-1/-2
Operating temperature range	+5 °C to +45 °C
Permissible temperature range	0 °C to +50 °C

Power supply	100 V to 120 V/220 V to 240 V +10%/–15% (autoranging), 50 Hz to 60 Hz
Power consumption	R&S®EFA40: 70 W R&S®EFA43: 75 W R&S®EFA43 + R&S®EFA-B3: 90 W
Dimensions (W × H × D)	435 mm × 147 mm × 460 mm (17.13 in × 5.79 in × 18.11 in)
Weight	approx. 12 kg (26.46 lb), depending on options

Ordering information

Designation	Type	Order No.
DVB-T Test Receiver⁵⁾ Selective, constellation diagram, MPEG-2 data stream output	R&S®EFA40	2067.3004.40
DVB-T Test Demodulator⁵⁾ Broadband, constellation diagram, MPEG-2 data stream output	R&S®EFA43	2067.3004.43

Ordering information for instruments described in data sheet PD 0758.2254.32

Designation	Type	Order No.
DVB-C Test Receiver, selective⁵⁾ 4/16/32/64/128/256 QAM, MPEG-2 data stream output, constellation diagram	R&S®EFA60	2067.3004.60
DVB-C Test Demodulator, broadband⁵⁾ 4/16/32/64/128/256 QAM, MPEG-2 data stream output, constellation diagram	R&S®EFA63	2067.3004.63
TV Test Receiver, Std. B/G, dual sound⁵⁾ IF 38.9 MHz, RF 45 MHz to 860 MHz, IEEE bus	R&S®EFA12	2067.3004.12
TV Demodulator, Std. B/G, dual sound⁵⁾ IF 38.9 MHz, RF 45 MHz to 1000 MHz, IEEE bus	R&S®EFA33	2067.3004.33
TV Test Receiver, Std. D/K or I (mono)⁵⁾ IF 38.9 MHz, RF 45 MHz to 860 MHz, IEEE bus	R&S®EFA78	2067.3004.78
TV Demodulator, Std. D/K or I (mono)⁵⁾ IF 38.9 MHz, RF 45 MHz to 1000 MHz	R&S®EFA89	2067.3004.89

Ordering information for instruments described in data sheet PD 0757.7017.21

Designation	Type	Order No.
ATSC/8VSB Test Receiver⁵⁾ Selective, constellation diagram, MPEG-2 data stream output	R&S®EFA50	2067.3004.50
ATSC/8VSB Test Demodulator⁵⁾ Broadband, constellation diagram, MPEG-2 data stream output	R&S®EFA53	2067.3004.53
ITU-T J.83/B Test Receiver⁵⁾ Selective, constellation diagram, MPEG-2 data stream output	R&S®EFA70	2067.3004.70
ITU-T J.83/B Test Demodulator⁵⁾ Broadband, constellation diagram, MPEG-2 data stream output	R&S®EFA73	2067.3004.73
TV Test Receiver, Std. M/N/NTSC/BTSC⁵⁾ RF 45 MHz to 860 MHz	R&S®EFA90	2067.3004.90
TV Demodulator, Std. M/N/NTSC/BTSC⁵⁾ RF 45 MHz to 1000 MHz	R&S®EFA93	2067.3004.93

Options

Designation	Type	Order No.
NICAM Demodulator for TV standard B/G, D/K	R&S®EFA-B2	2067.3610.02
NICAM Demodulator for TV standard I	R&S®EFA-B2	2067.3610.04
RF Selection for demodulators (models .33/43/53/63/73/89/93)	R&S®EFA-B3	2067.3627.02
MPEG-2 Decoder	R&S®EFA-B4	2067.3633.02
Video Distributor (four video outputs, only models .33/89/93)	R&S®EFA-B6	2067.3656.02

⁵⁾ Please fill in configuration sheet (available from your local representative or from the Rohde & Schwarz website, search term: EFA) so that your test receiver/demodulator can be tailored to your requirements.

Designation	Type	Order No.
Switchable Sound Trap (for models .12/33)	R&S®EFA-B7	2067.3710.02
OFDM Demodulator	R&S®EFA-B10	2067.3740.02
6 MHz SAW Filter (for digital R&S®EFA models or R&S®EFA-B10, R&S®EFA-B20)	R&S®EFA-B11	2067.3691.00
7 MHz SAW Filter (for digital R&S®EFA models or R&S®EFA-B10, R&S®EFA-B20)	R&S®EFA-B12	2067.3556.02
8 MHz SAW Filter (for R&S®EFA4x or R&S®EFA-B10)	R&S®EFA-B13	2067.3579.02
8 MHz SAW Filter (for R&S®EFA5x/6x/7x or R&S®EFA-B20)	R&S®EFA-B13	2067.3579.03
2 MHz SAW Filter (for R&S®EFA5x/6x/7x or R&S®EFA-B20)	R&S®EFA-B14	2067.3562.00
Digital Demodulator Platform	R&S®EFA-B20	2067.3585.02
M/N/NTSC/BTSC Demodulator	R&S®EFA-B30	2067.4046.02

Firmware options

Designation	Type	Order No.
SFN Frequency Offset Measurement (for R&S®EFA4x or R&S®EFA-B10)	R&S®EFA-K10	2067.9454.02
DVB-C/J.83/A,C (QAM) Firmware (for models .50/53/70/73 or R&S®EFA-B20)	R&S®EFA-K21	2067.4000.02
ATSC/8VSB Firmware (for models .60/63/70/73 or R&S®EFA-B20)	R&S®EFA-K22	2067.4017.02
J.83/B (QAM) Firmware (for models .50/53/60/63 or R&S®EFA-B20)	R&S®EFA-K23	2067.4023.02
FIR Coefficient Readout Firmware (only for R&S®EFA5x or R&S®EFA-B20 + R&S®EFA-K22)	R&S®EFA-K25	2067.4046.02

Recommended extras

Designation	Type	Order No.
R&S®EFA-SCAN Measurement Software (for all digital modules)	R&S®EFA-K1	2067.9202.02
R&S®EFA Calibration Values	R&S®EFA-DCV	2082.0490.09
R&S®EFA-B4 Calibration Values	R&S®EFA-DCV	2082.0490.15
19" Adapter	R&S®ZZA-93	0396.4892.00
Lemo Triax connector (mono) with connecting cable (open)		2067.7451.00
Service manual		2068.0950.24
Carrying Bag for 19" units, 3 height units, depth 460 mm	R&S®ZZT-314	1001.0523.00



More information at
www.rohde-schwarz.com
(search term: EFA40, EFA43)



www.rohde-schwarz.com

Europe: +49 1805 12 4242, customersupport@rohde-schwarz.com
USA and Canada: 1-888-837-8772, customer.support@rsa.rohde-schwarz.com
Asia: +65 65 130 488, customersupport.asia@rohde-schwarz.com