



ABN 43 064 478 842

231 Osborne Avenue Clayton South, VIC 3169
PO Box 1548, Clayton South, VIC 3169
t 03 9265 7400 f 03 9558 0875
freecall 1800 680 680
www.tmgtestequipment.com.au

Test & Measurement

- > sales
- > rentals
- > calibration
- > repair
- > disposal

Complimentary Reference Material

This PDF has been made available as a complimentary service for you to assist in evaluating this model for your testing requirements.

TMG offers a wide range of test equipment solutions, from renting short to long term, buying refurbished and purchasing new. Financing options, such as Financial Rental, and Leasing are also available on application.

TMG will assist if you are unsure whether this model will suit your requirements.

Call TMG if you need to organise repair and/or calibrate your unit.

If you click on the "Click-to-Call" logo below, you can call us for FREE!

TMG Corporate Website

TMG Products Website



Click-to-Call
TMG Now



Product Lifecycle Management System

Disclaimer:

All trademarks appearing within this PDF are trademarks of their respective owners.



Instruction Manual

Tektronix

P5200

High Voltage Differential Probe

070-9018-04

Copyright © Tektronix, Inc. All rights reserved.

Tektronix products are covered by U.S. and foreign patents, issued and pending. Information in this publication supercedes that in all previously published material. Specifications and price change privileges reserved.

Tektronix, Inc., P.O. Box 500, Beaverton, OR 97077

TEKTRONIX, TEK, and TEKPROBE are registered trademarks of Tektronix, Inc.

Warranty 2

Tektronix warrants that this product will be free from defects in materials and workmanship for a period of one (1) year from the date of shipment. If any such product proves defective during this warranty period, Tektronix, at its option, either will repair the defective product without charge for parts and labor, or will provide a replacement in exchange for the defective product. Parts, modules and replacement products used by Tektronix for warranty work may be new or reconditioned to like new performance. All replaced parts, modules and products become the property of Tektronix.

In order to obtain service under this warranty, Customer must notify Tektronix of the defect before the expiration of the warranty period and make suitable arrangements for the performance of service. Customer shall be responsible for packaging and shipping the defective product to the service center designated by Tektronix, with shipping charges prepaid. Tektronix shall pay for the return of the product to Customer if the shipment is to a location within the country in which the Tektronix service center is located. Customer shall be responsible for paying all shipping charges, duties, taxes, and any other charges for products returned to any other locations.

This warranty shall not apply to any defect, failure or damage caused by improper use or improper or inadequate maintenance and care. Tektronix shall not be obligated to furnish service under this warranty a) to repair damage resulting from attempts by personnel other than Tektronix representatives to install, repair or service the product; b) to repair damage resulting from improper use or connection to incompatible equipment; c) to repair any damage or malfunction caused by the use of non-Tektronix supplies; or d) to service a product that has been modified or integrated with other products when the effect of such modification or integration increases the time or difficulty of servicing the product.

THIS WARRANTY IS GIVEN BY TEKTRONIX WITH RESPECT TO THE PRODUCT IN LIEU OF ANY OTHER WARRANTIES, EXPRESS OR IMPLIED. TEKTRONIX AND ITS VENDORS DISCLAIM ANY IMPLIED WARRANTIES OF MERCHANTABILITY OR FITNESS FOR A PARTICULAR PURPOSE. TEKTRONIX' RESPONSIBILITY TO REPAIR OR REPLACE DEFECTIVE PRODUCTS IS THE SOLE AND EXCLUSIVE REMEDY PROVIDED TO THE CUSTOMER FOR BREACH OF THIS WARRANTY. TEKTRONIX AND ITS VENDORS WILL NOT BE LIABLE FOR ANY INDIRECT, SPECIAL, INCIDENTAL, OR CONSEQUENTIAL DAMAGES IRRESPECTIVE OF WHETHER TEKTRONIX OR THE VENDOR HAS ADVANCE NOTICE OF THE POSSIBILITY OF SUCH DAMAGES.

Table of Contents

General Safety Summary	iii
Observe Maximum Working Voltage	iii
Service Safety Summary	vi
Contacting Tektronix	vi
Features and Accessories	1
Getting Started	5
Installation	5
Functional Check	6
Operating Basics	7
Operating the Probe Safely	7
Minimizing Risk of RF Burn (probe leads)	8
Maximum Input Limits	8
Operating Characteristics and Probing Techniques	9
Operating Limits	9
Overrange Detection	10
Common-Mode Rejection	10
Twisting the Input Leads	11
Extension Leads	12
Probe Loading	13
Specifications	15
Warranted Characteristics	15
Certification and Compliances	16
Typical Characteristics	19
Nominal Characteristics	20
User Service	21
Cleaning	21
Packaging for Shipment	21
Performance Verification	25
Construction of Modified BNC Adapter	26
Setup	27
Amplitude Accuracy	28
Rise Time	30
DC CMRR	31

Table of Contents

Replaceable Parts	33
Parts Ordering Information	33
Using the Replaceable Parts List	34

General Safety Summary

Review the following safety precautions to avoid injury and prevent damage to this product or any products connected to it. To avoid potential hazards, use this product only as specified.

Only qualified personnel should perform service procedures.

Observe Maximum Working Voltage

Do not use the P5200 High Voltage Differential Probe above 1,000 V_{RMS} CAT II from ground on either input or $\pm 1,300$ V (DC + peak AC) between the leads.

To Avoid Fire or Personal Injury

Avoid RF Burns While Handling Probe. To avoid RF burns, do not handle the probe while the input leads are connected to circuits above the voltage and frequency limits specified in Figure 2 on page 9. Use only probe accessories that are rated for the application.

Connect and Disconnect Properly. Connect the probe output to the measurement instrument before connecting the probe to the circuit under test. Disconnect the probe input and the probe ground from the circuit under test before disconnecting the probe from the measurement instrument.

Ground the Product. This product is indirectly grounded through the grounding conductor of the mainframe power cord. To avoid electric shock, the grounding conductor must be connected to earth ground. Before making connections to the input or output terminals of the product, ensure that the product is properly grounded.

Observe All Terminal Ratings. To avoid fire or shock hazard, observe all ratings and markings on the product. Consult the product manual for further ratings information before making connections to the product.

Use Proper AC Adapter. Use only the AC adapter specified for this product.

Do Not Operate Without Covers. Do not operate this product with covers or panels removed.

Avoid Exposed Circuitry. Do not touch exposed connections and components when power is present.

Do Not Operate With Suspected Failures. If you suspect there is damage to this product, have it inspected by qualified service personnel.

Do Not Operate in Wet/Damp Conditions.

Do Not Operate in an Explosive Atmosphere.

Keep Product Surfaces Clean and Dry.

Safety Terms and Symbols

Terms in This Manual. These terms may appear in this manual:



WARNING. *Warning statements identify conditions or practices that could result in injury or loss of life.*



CAUTION. *Caution statements identify conditions or practices that could result in damage to this product or other property.*

Terms on the Product. These terms may appear on the product:

DANGER indicates an injury hazard immediately accessible as you read the marking.

WARNING indicates an injury hazard not immediately accessible as you read the marking.

CAUTION indicates a hazard to property including the product.

Symbols on the Product. These symbols may appear on the product:



CAUTION
Refer to Manual



WARNING
High Voltage



Double
Insulated



Protective Ground
(Earth) Terminal



Service Safety Summary

Only qualified personnel should perform service procedures. Read this *Service Safety Summary* and the *General Safety Summary* before performing any service procedures.

Do Not Service Alone. Do not perform internal service or adjustments of this product unless another person capable of rendering first aid and resuscitation is present.

Use Care When Servicing with Power On. Dangerous voltages or currents may exist in this product. Disconnect power, remove battery (if applicable), and disconnect test leads before removing protective panels, soldering, or replacing components.

To avoid electric shock, do not touch exposed connections.

Contacting Tektronix

Phone	1-800-833-9200*
Address	Tektronix, Inc. Department or name (if known) 14200 SW Karl Braun Drive P.O. Box 500 Beaverton, OR 97077 USA
Web site	www.tektronix.com
Sales support	1-800-833-9200, select option 1*
Service support	1-800-833-9200, select option 2*
Technical support	www.tektronix.com/support 1-800-833-9200, select option 3* 6:00 a.m. - 5:00 p.m. Pacific Standard Time

* **This phone number is toll free in North America. After office hours, please leave a voice mail message. Outside North America, contact a Tektronix sales office or distributor; see the Tektronix web site for a list of offices.**

Features and Accessories

The P5200 High Voltage Differential Probe in Figure 1 provides a safe means of measuring circuits with floating potentials up to 1,000 V_{RMS} CAT II from earth ground and up to 1,300 V (DC + peak AC) differential. This probe must be connected to an oscilloscope or other measurement instrument in which the input BNC connector is at ground potential. The probe is a safe alternative to the extremely dangerous practice of disconnecting the oscilloscope ground to achieve a floating measurement.

The P5200 probe allows clear and accurate measurements of high-speed transitions and provides excellent common-mode rejection of noisy signals. Both inputs have high impedance and low capacitance. Because of these features, the probe can safely measure the fast voltage transients in switching power devices such as IGBTs, power MOSFETs, thyristors, GTOs, and bipolar transistors without damaging these devices.

Other applications for the P5200 probe include testing high-voltage motor control circuits and line connected circuits in switch-mode power supplies.



WARNING. *To avoid an electric shock, do not use the P5200 High Voltage Differential Probe with oscilloscopes that have floating inputs (isolated inputs), such as the Tektronix TPS2000 series oscilloscopes and THS700 series oscilloscopes. The P5200 High Voltage Differential Probe requires an oscilloscope or other measurement instrument with a grounded input.*

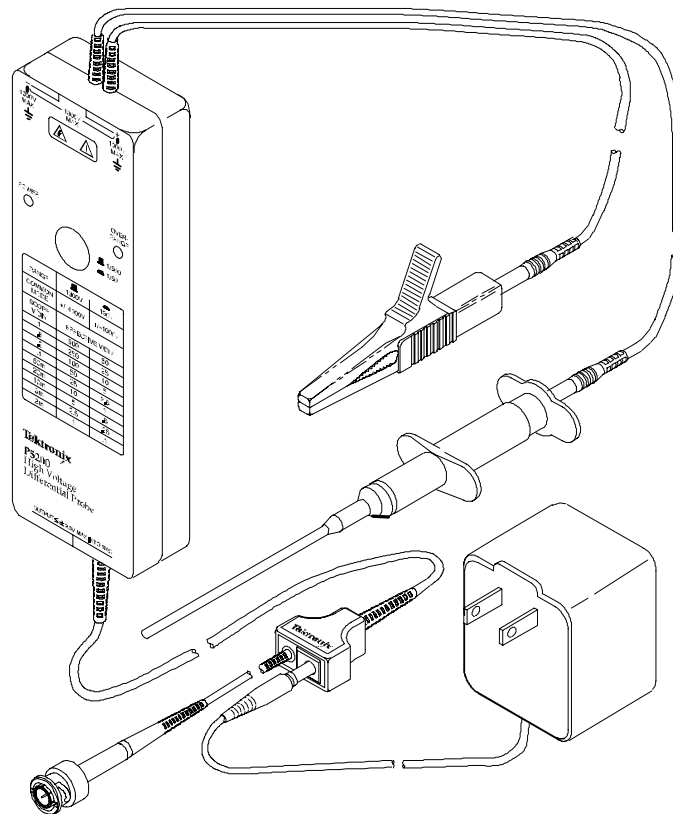
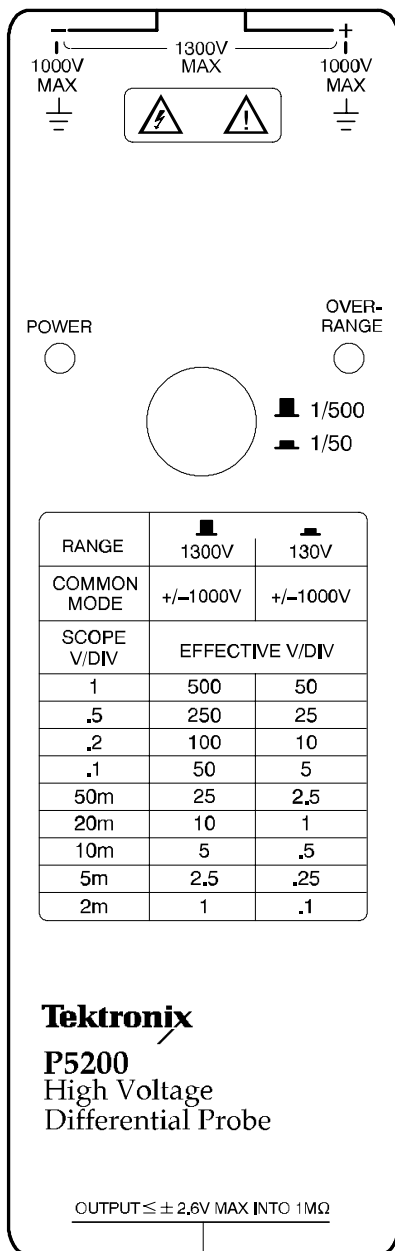

Figure 1: P5200 High Voltage Differential Probe

The P5200 has several features and accessories that make probing and measurement a simpler task. Take a moment to familiarize yourself with these items and their uses.

POWER





Power Indicator. The power indicator lights green to show that power from the AC adapter is present.

OVER-RANGE





Overrange Indicator. The overrange indicator lights red if the voltage of the input signal exceeds the linear range of the range setting. When this happens, the signal on the probe output does not accurately represent the signal on the probe input.

 1/500

 1/50

Range Button. In the raised position the range button sets the attenuation to 1/500. In the lowered position the range button sets the attenuation to 1/50.

Use the 1/500 position for connections above 130 V up to a maximum of 1,300 V differential. Use the 1/50 position for better signal resolution on connections below 130 V (DC + peak AC). Both range settings are rated for a maximum of 1,000 V_{RMS} CAT II common mode.

RANGE	 1300V	 130V
COMMON MODE	+/-1000V	+/-1000V
SCOPE V/DIV	EFFECTIVE V/DIV	
1	500	50
.5	250	25
.2	100	10
.1	50	5
50m	25	2.5
20m	10	1
10m	5	.5
5m	2.5	.25
2m	1	.1

Scale Conversion Chart. The chart lists the effective volts per division for the 1/500 and 1/50 range settings and scale factors of 2 mV to 1 V on the measurement instrument.

The effective volts per division is the attenuation factor of 500 or 50 multiplied by the scale factor of the measurement instrument. For example, with the range set to 1/500 and the measurement instrument sensitivity set to 0.5 volts/division, the effective volts per division equals 500×0.5 or 250 V.

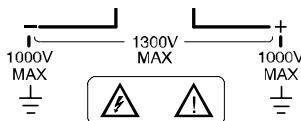

Differential Inputs. The inputs accept a maximum of 1,000 V_{RMS} CAT II between either input and ground and a maximum difference of 1,300 V (DC + peak AC) between the inputs. These input ratings are valid for both range settings.

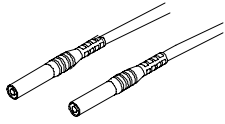

Input Leads. The input leads of the differential probe connect to the crocodile clips and plunger probes that come with the probe. The connectors are double insulated for safety.

NOTE. Use only the accessories provided with the P5200 probe.

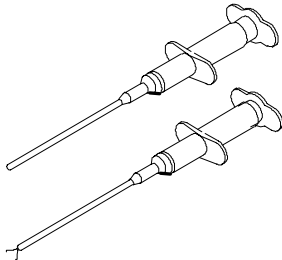

Plunger Probes. The plunger probes have long probe sleeves with retracting hooks. These probes connect safely to recessed test points that are otherwise difficult to reach. The connectors are double insulated for safety.

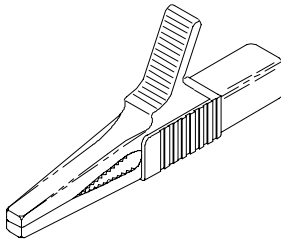

Crocodile Clips. The large insulated clips connect easily to large bolts or bus bars. The connectors are double insulated for safety.

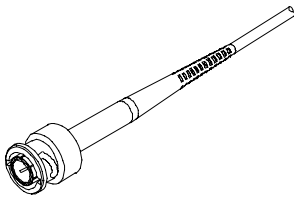

Output Lead. The BNC output connection to the oscilloscope is calibrated to drive a high impedance (1 M Ω) load.

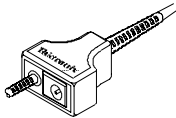

Adapter Jack. The power supply jack on the probe output connects to the 9 VDC plug of the AC adapter.

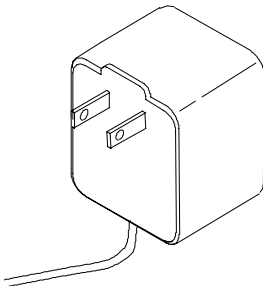

AC Adapter. The adapter converts AC line voltage to 9 VDC for the probe power supply.

NOTE. The AC adapter that accompanies the P5200 probe is the only adapter specified for this probe. Using any other adapter voids the product warranty and may also produce electromagnetic interference. Adapters for the line voltages of other countries are also available. Refer to the *Replaceable Parts* section, which begins on page 33.

Getting Started

To safely install and functionally check the P5200 High Voltage Differential Probe, follow the procedures in this section.

Installation

Install the P5200 probe as follows:

1. Connect the output of the probe to the BNC input of the oscilloscope or other measurement instrument. The measurement instrument input must have a ground reference.
2. Connect the AC adapter to the jack located on the output lead of the probe.
3. Connect the AC adapter to the proper line voltage. The green power LED on the probe should light.
4. Adjust the vertical offset (or position) of the measurement instrument input.
5. Select the proper range setting. For higher resolution and less noise when measuring signals below 130 V, switch the attenuation to 1/50. If the overrange indicator lights or flashes, the output signal may not be accurate. Use the 1/500 setting instead.
6. Set the volts per division setting on the measurement instrument to the range indicated in the table on the front panel of the probe.



WARNING. *To avoid electrical shock, observe proper safety precautions when working with voltages above 60 VDC or 30 VAC_{RMS}. These voltage levels pose a shock hazard. Make sure that the test leads are in good condition. Use only the accessories supplied with the P5200 probe.*

7. Using the appropriate probe accessories, connect the inputs of the probe to the voltage source.



CAUTION. To avoid damaging the input circuitry of the P5200 probe, do not apply a voltage that is in excess of 1,000 V_{RMS} CAT II between either input and ground or more than 1,300 V (DC + peak AC) between the two inputs. This voltage rating applies to both 1/50 and 1/500 settings.

Functional Check

To make a simple functional check of the P5200 probe, select a source that supplies AC line voltage and use the following procedure. This procedure verifies a majority of the circuitry within the probe. For a complete performance verification, refer to page 25 of the *Performance Verification* section.

1. Use the installation procedure starting on page 5 to connect the output of the P5200 probe to a measurement instrument.
2. Connect the inputs, set the range, and perform the check as each line of Table 1, below, indicates.

This completes the functional check procedure.

Table 1: Functional check

Input 1 (+ or -)	Input 2 (- or +)	Mode	Range Setting	Check
Hot	Ground or Neutral	Differential	1/500 (out)	Measurement instrument displays or indicates the line voltage
Hot	Ground or Neutral	Differential	1/50 (in)	Overrange indicator lights if the input is > 130 Vp
Hot	Hot (same connection)	Common Mode	1/50 or 1/500	No signal

Operating Basics

To help you use the P5200 High Voltage Differential Probe safely and effectively, this section provides important information about safety limits, operating characteristics, and probing techniques.



WARNING. *Due to the inherent hazards associated with taking high-voltage measurements, the product is intended for use by qualified personnel who have had the training to make these types of measurements. Read and follow the precautions specified in this manual.*

Before you make any oscilloscope measurement, observe all safety precautions described in the user and service manuals for the equipment you are working on. Some general rules about using and servicing electrical equipment are worth repeating here.

- Observe the safety instruction symbols for the equipment you are working on.
- Consult the instruction or service manuals for the equipment you are working on.
- Don't operate or service an electrical device in an explosive atmosphere.
- Avoid personal injury by never touching exposed connections or components in the circuit-under-test when the power is on.

Operating the Probe Safely

Before connecting the inputs of the probe to a circuit, read the safety information in this section and attach the appropriate accessories to the input connectors of the probe.

Minimizing Risk of RF Burn (probe leads)



WARNING. To avoid personal injury, do not handle the probe leads when the leads are connected to a source that is above the voltage and frequency limits given in Figure 2 on page 9. The area above these limits poses a risk of radio frequency (RF) burns.

If you need to use the probe within the risk area for RF burn, power off the source before connecting or disconnecting the probe leads.

Maximum Input Limits



CAUTION. To avoid damaging the input circuitry of the P5200 probe, do not apply a voltage that is more than 1,000 V_{RMS} CAT II between either input and ground or more than 1,300 V (DC + peak AC) between the two inputs. Above 3 MHz, the voltage limit decreases as frequency increases. See Figure 2 on page 9. The input limit applies to both the 50X and 500X settings.

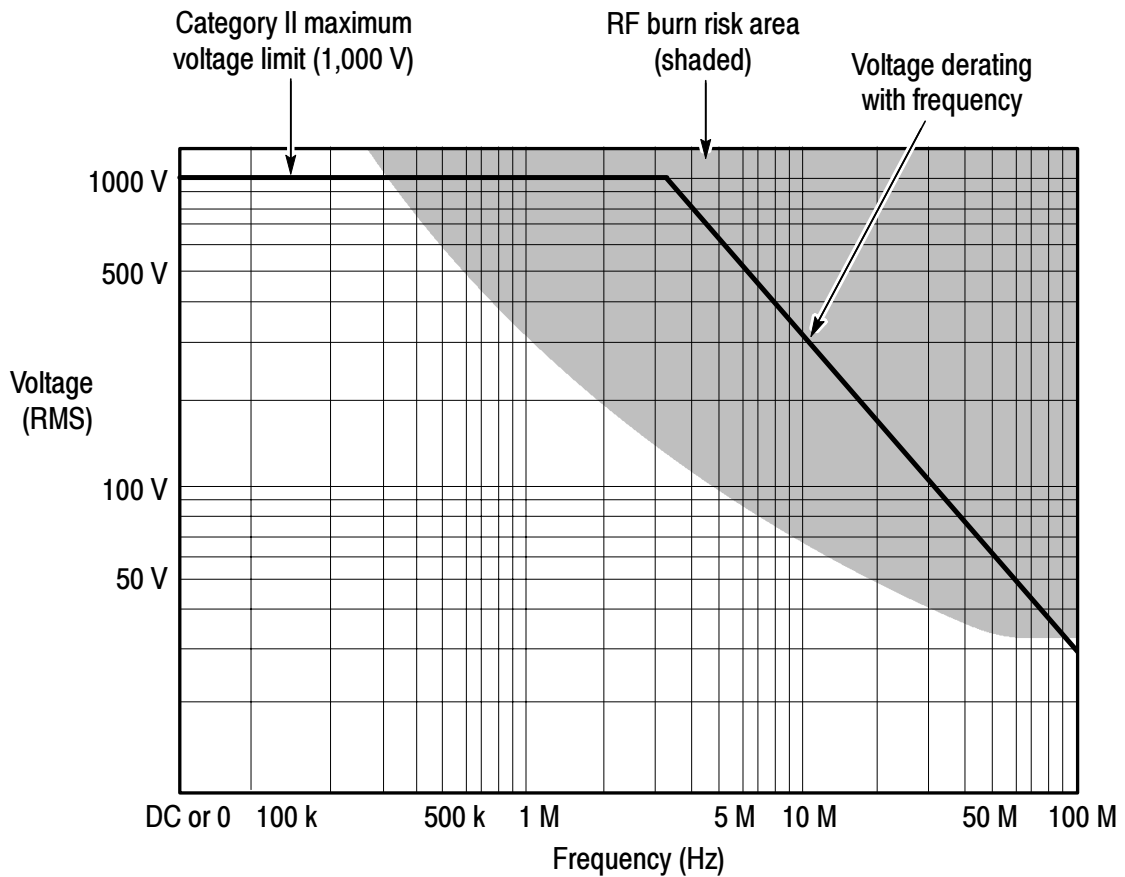

Figure 2: Safety limits (voltage between either input and earth ground)

Operating Characteristics and Probing Techniques

This section explains the operating characteristics of the P5200 probe along with techniques you can use to maximize the performance of the probe.

Operating Limits

The P5200 probe has two operating ranges that you select with the ATTENUATION button on the front panel:

- Select the 50X range for inputs of 0 V to 130 V (DC + peak AC).
- Select the 500X range for inputs of 130 V to 1300 V (DC + peak AC).

Both ranges are rated for the maximum input limits, but you can obtain a useful measurement only if the voltage you apply is within the specified limits of the operating range.

Overrange Detection

Differential voltage outside the operating range will overdrive the circuitry of the probe and distort the output signal. When this differential overrange occurs, the probe detects the condition and lights the overrange indicator. With the Audible Overrange ON, the probe will also emit an audible alarm.

Common-mode voltage greater than 1,000 V_{RMS} can distort the output signal, but the probe will not indicate an overrange condition.

Common-Mode Rejection

The common-mode rejection ratio (CMRR) is the specified ability of P5200 High Voltage Differential Probe to reject signals that are common to both inputs. More precisely, CMRR is the ratio of the differential gain to the common-mode gain. The higher the ratio, the greater the ability of probe to reject common-mode signals. For exact specifications, see Table 4 on page 19 of the *Specifications* section.

Common mode rejection decreases as the input frequency increases. Figure 3 on page 11 is a plot of typical CMRR of the probe versus input frequency. For example, if you apply a 60 Hz line voltage of 500 V_{P-P} to both input leads of the probe, the probe rejects the signal by 80 dB (typical) and the signal appears as only a 50 mV_{P-P} signal on the oscilloscope screen.

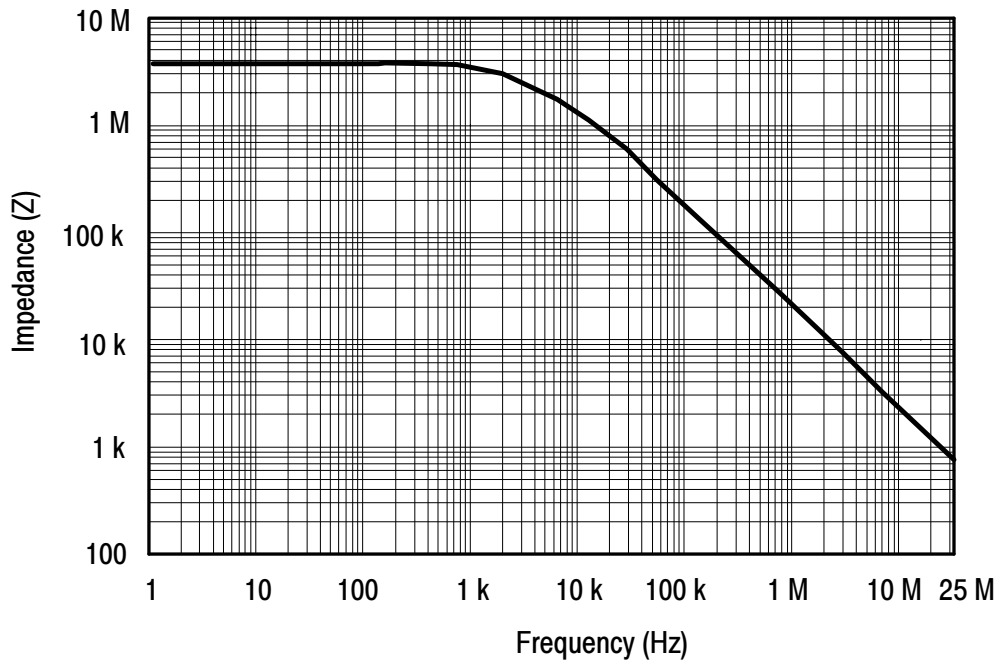

Figure 3: Input impedance vs. frequency

To maximize the rejection of common-mode signals, twist the input leads together, as shown in Figure 4 on page 12, and do not use the extension leads.

Twisting the Input Leads

Twisting the input leads as shown in Figure 4 on page 12 helps to cancel noise that is induced into the input leads, and to improve the high frequency response of the inputs. For the best response possible, do not use the extension leads.

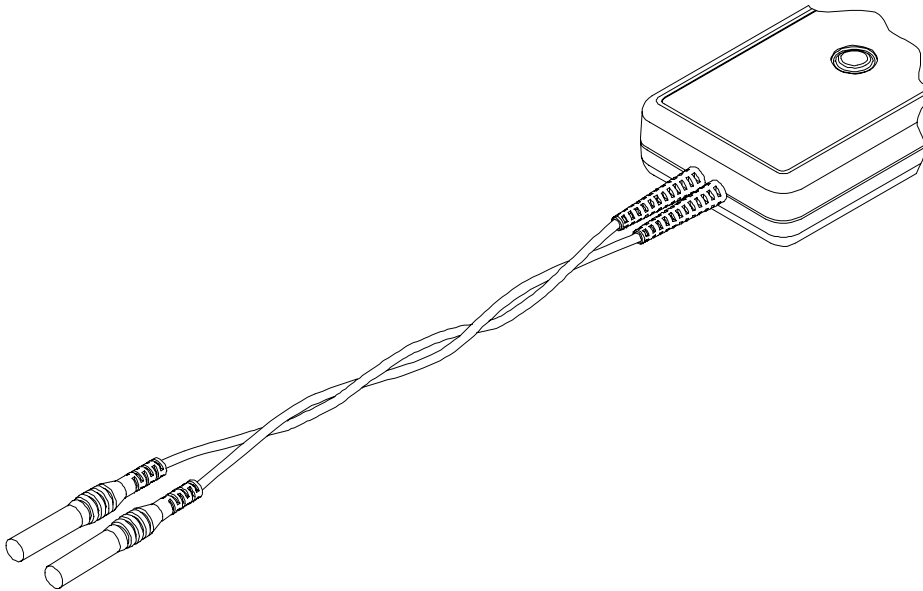

Figure 4: Twisting the input leads

Extension Leads

The extension leads allow you to reach widely spaced connection points. Connect the extension leads to the input leads using the adapters provided. Be sure to use both extension leads so that the input leads are the same length.

The extension leads, however, do affect the high-frequency performance of the probe. With longer lead length, differential noise induced into the input leads is greater. Also, because of the added inductance of the leads, voltage measurements at frequencies above approximately 10 MHz may not be as precise. Figure 5 on page 13 shows the effect on HF transient response.

The extension leads do not affect the performance of the probe when bandwidth is set to 5 MHz.

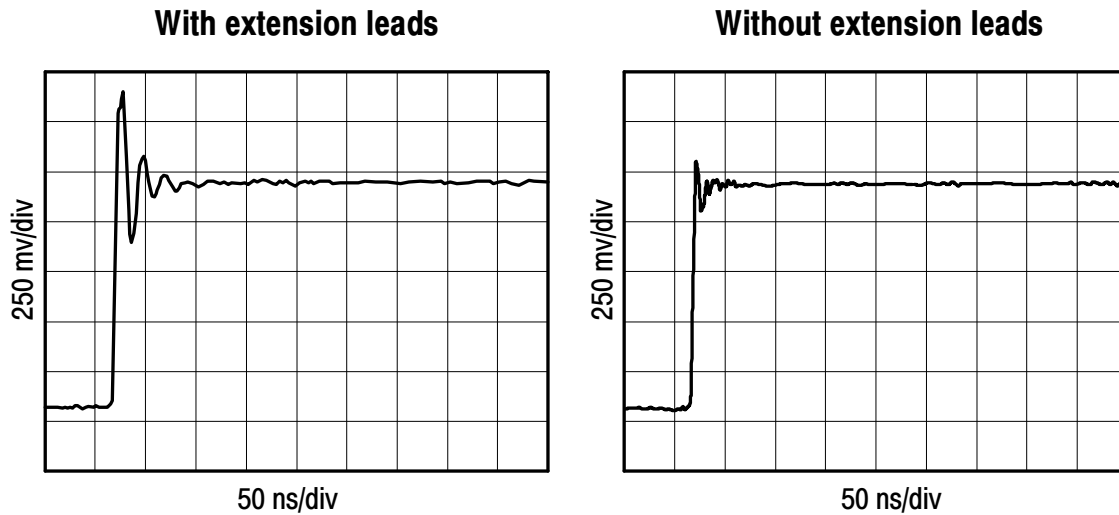

Figure 5: HF transient response with and without extension leads

Probe Loading

When you touch your probe tip to a circuit element, you are introducing a new resistance, capacitance, and inductance into the circuit.

Frequency and impedance of the source determine how much the probe loads the circuit that you are measuring. As the frequency of the source starts to increase beyond 1 kHz, the input impedance of the probe begins to decrease. The lower the impedance of the probe relative to that of the source, the more the probe loads the circuit under test.

The probe has virtually no loading effect on sources with relatively low impedance and low frequency.

Specifications

The specifications in Tables 2 through 6 apply to a P5200 High Voltage Differential Probe installed on a Tektronix TDS460A oscilloscope. When the probe is used with another oscilloscope, the oscilloscope must have an input impedance $1\text{ M}\Omega$, an input capacitance range of between 15 and 20 pF, and a bandwidth not less than 100 MHz.

The probe must have a warm-up period of at least 20 minutes and be in an environment that does not exceed the limits described in Table 2 on page 15.

Specifications for the P5200 probe fall into three categories: warranty, typical, and nominal characteristics.



WARNING. *Special fixtures are required to examine specifications at the maximum frequency and voltage levels and should be conducted only by qualified Service Personnel. See the Service section for more details.*

Warranted Characteristics

The warranted characteristics in Tables 2 and 3 describe guaranteed performance within tolerance limits or certain type-tested requirements. Warranted characteristics that have check procedures in the *Performance Verification* section appear in **boldface** type.

Table 2: Warranted Electrical Characteristics

Rise Time	< 14 ns in 1/50 range setting
DC Common Mode Rejection Ratio (20-30°C, <70% RH)	> 3000:1 at 500 VDC
Bandwidth	DC to 25 MHz (-3dB) in 1/50 range setting

Table 2: Warranted Electrical Characteristics (Cont.)

Maximum Operating Input Voltage	1/500 differential: ± 1.3 kV (DC + peak AC) 1/500 common mode: ± 1 kV _{RMS} CAT II 1/50 differential: ± 130 V (DC + peak AC) 1/50 common mode: ± 1 kV _{RMS} CAT II
Maximum Nondestructive Input Voltage	1/500 and 1/50 differential: ± 1.3 kV (DC + peak AC) 1/500 and 1/50 common mode: ± 1 kV _{RMS} CAT II
Range Accuracy	$\pm 3\%$ at 20-30° C, <70% RH after 20 minute warm up
Temperature	Operating: 0 to 40° C Nonoperating: -30 to +70° C
Humidity	Operating: 25 to 85% RH, +25° to +35° C Nonoperating: 25 to 85% RH, +25° to +60° C
Certification and Compliances	
EC Declaration of Conformity - Low Voltage	Compliance was demonstrated to the following specification as listed in the Official Journal of the European Communities: Low Voltage Directive 73/23/EEC, as amended by 93/68/EEC: EN 61010-1/A2:1995 - Safety requirements for electrical equipment for measurement, control, and laboratory use EN 61010-2-031:1994 - Particular requirements for hand-held probe assemblies for electrical measurement and test equipment

Table 2: Warranted Electrical Characteristics (Cont.)

Approvals	<p>UL3111-1 - Standard for electrical measuring and test equipment</p> <p>IEC 10106-2-031 - Particular requirements for hand-held probe assemblies for electrical measurement and test</p> <p>CAN/CSA-C22.2 No. 1010.1-92 and CAN/CSA-C22.2 No. 1010.2.031-94 - Safety requirements for electrical equipment for measurement, control, and laboratory use</p>
Installation Category Descriptions	<p>Terminals on this product may have different installation category designations. The installation categories are:</p> <p>CAT III Distribution-level mains (usually permanently connected). Equipment at this level is typically in a fixed industrial location</p> <p>CAT II Local-level mains (wall sockets). Equipment at this level includes appliances, portable tools, and similar products. Equipment is usually cord-connected</p> <p>CAT I Secondary (signal level) or battery operated circuits of electronic equipment</p>
Pollution Degree 2	<p>Do not operate in environments where conductive pollutants may be present.</p>

Table 3: Warranted Environmental Characteristics

Radiated and Conducted Emissions	FCC Code 47 CFR. Part 15, Subpart B, Class A VFG 0243 Enclosure: EN 5502 Class B limits for radiated emissions AC Mains: EN 55022 Class B limits for conducted emissions and EN 60555-2 AC power harmonic emissions
To ensure compliance with the above requirements, only high quality shielded interface cables should be attached to this instrument. High quality cables have a reliable, continuous outer shield (braid and foil) that has low impedance connections to shielded connector housings at both ends. The following cables meet this criteria: GPIB: Tektronix part numbers 012-0991-00, -01, -02, -03 RS-232: Tektronix part number 012-1380-00 Printer: Tektronix part number 012-1250-00	
Immunity, Enclosure, Radio Frequency Electromagnetic Field	IEC 801-3 Tested with TDS460 set to 50 mV/Div vertically and 500 μ s/Div horizontally
Immunity, Enclosure, Electrostatic Discharge (ESD)	8 kV, IEC 801-2
Immunity, Fast Transients, Common Mode	IEC 801-4
Immunity, AC Power Line Transients	IEC 801-5

Typical Characteristics

The typical characteristics in Tables 4 and 5 describe typical, but not guaranteed, performance.

Table 4: Typical Electrical Characteristics

Rise Time	< 14 ns in 1/500 range setting
Bandwidth	DC to 25 MHz (-3dB) in 1/500 range setting
AC Common-Mode Rejection Ratio (20-30°C, <70% RH)	60 Hz: > 10,000:1 -80 dB 100 kHz: > 300:1 -50 dB 1 MHz: > 300:1 -50 dB
Noise (measured tangentially)	< 4 mV _{RMS}
Input Impedance	8 MΩ, 3.5 pF between inputs 4 MΩ, 7 pF between each input and ground
DC Output Drift	±0.5 mV/°C
Propagation Delay	20 nS

Table 5: Typical Mechanical Characteristics

Dimensions, Case	185 mm × 66 mm × 32 mm (7.2 in × 2.6 in × 1.3 in)
Dimensions, Input Leads	46 cm (18 in)
Dimensions, Output Cable	1.8 m (6 ft)
Unit Weight (probe only)	315 g (11 oz)
Shipping Weight (with accessories)	1.42 kg (3 lb, 2 oz)

Nominal Characteristics

The Nominal characteristics shown in Table 6 describe guaranteed traits, but the traits do not have tolerance limits.

Table 6: Nominal Electrical Characteristics

Input Type	Balanced differential
Output Type	Single-ended, load impedance must be greater than 50 k Ω for stated accuracy
Range Settings	Switchable: 1/50 and 1/500

User Service

The P5200 High Voltage Differential Probe contains no user serviceable components or adjustments. The accessories are replaceable. For information, see *Replaceable Parts* on page 33.

For terms of the product warranty, refer to the front of this manual. Should the probe require replacement under terms of the warranty, return the probe to a Tektronix service center. Include the following information: name of purchaser, return address, name and phone number of a person that Tektronix may contact, date of purchase, and a description of the defect. Refer to *Contacting Tektronix* on page vi.

Cleaning

To prevent damage to probe materials, avoid using chemicals that contain benzene, benzene, toluene, xylene, acetone, or similar solvents.

Do not immerse the probe or use abrasive cleaners.

Dirt may be removed with a soft cloth dampened with a mild solution of detergent and water, or isopropyl alcohol.

Packaging for Shipment

If the original packaging is unfit for use or not available, use the following packaging guidelines:

1. Select a sturdy shipping carton that has inside dimensions at least one inch greater than the probe dimensions.
2. Put the probe into a plastic bag or wrap to protect it from dampness.
3. Place the probe into the box and stabilize it with light packing material. Seal the carton with shipping tape.



WARNING

The following servicing instructions are for use only by qualified personnel. To avoid injury, do not perform any servicing other than that stated in the operating instructions unless you are qualified to do so. Refer to all safety summaries before performing any service.

Performance Verification

The following procedure verifies the warranted electrical characteristics of the P5200 High Voltage Differential Probe. Table 7 itemizes the equipment required, provides an example or part number of the equipment, and explains the purpose of the equipment.

Table 7: List of equipment required

Description	Minimum requirements	Example or part number	Purpose
Test oscilloscope	Bandwidth: ≥ 100 MHz Vertical Accuracy: $\leq 1.5\%$	TDS460A or TDS784A	Display probe output
Standard amplitude generator	Amplitude accuracy: $\leq 0.75\%$	Fluke/Wavetek 9100 with oscilloscope option 250	Check probe attenuation, bandwidth, common-mode rejection ratio
Leveled sine wave generator	Rise time (standard amplitude): ≤ 3 ns		
DC voltage source			
Plunger probe (2 required)	Use probes Included in accessory kit	Accessory kit 020-2106-00	Connection to binding post
Modified BNC adapter	BNC-male-to-dual binding post	103-0035-00	Interconnection between probe and Generator. (See Figure 6 on page 26)
BNC adapter	BNC-female-to-dual banana	103-0090-00	Interconnection between probe and Generator
Coaxial cables (2 required)	36 in (0.9144 m), precision 50Ω	012-0482-00	Interconnection between oscilloscope and generator
Terminator	50Ω precision feed through	011-0049-01	Interconnection between probe and generator during rise time measurements

Construction of Modified BNC Adapter

Construct the modified BNC Adapter from a BNC-male-to-dual binding post adapter, Tektronix part number 103-0035-00 (see Figure 6).

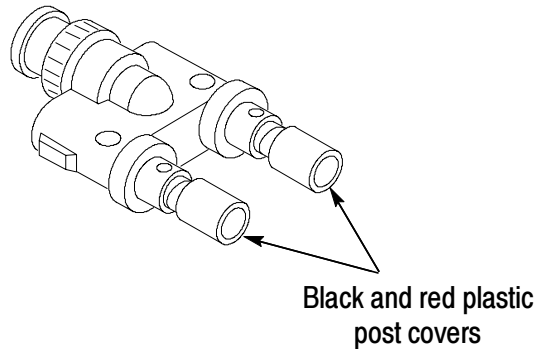

Figure 6: BNC-male-to-dual binding post adapter

To expose the posts that you will connect the P5200 High-Voltage Differential probe leads to, remove the black and red plastic post covers of the BNC-male-to-dual adapter. Use a pair of pliers and a vise to remove the plastic covers, as shown in Figure 7 on page 27.

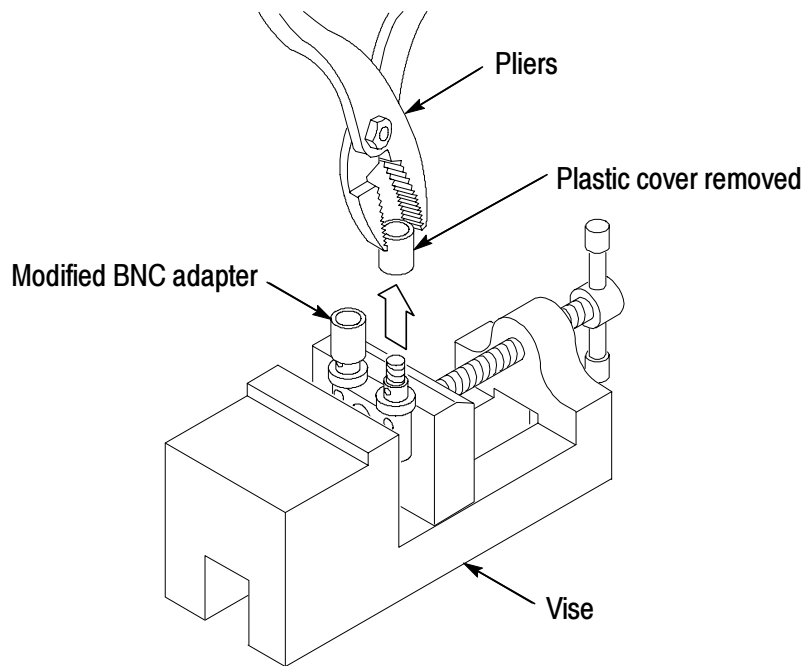

Figure 7: Removing plastic covers from binding posts

Setup



WARNING. *These procedures require the application of high voltage to the inputs of the P5200 probe. Because this adapter has exposed metal surfaces, only qualified personnel should perform any testing with voltage levels exceeding 30 V rms. All pertinent safety rules and guidelines for elevated voltage measurements should be followed and adhered to.*

1. Connect the output of the probe to the Channel 3 of the test oscilloscope. Let the probe warm up for 20 minutes.
2. Connect the 9 VDC output plug of the AC adapter to the input jack of the probe, and then connect the AC adapter to the correct line voltage. The green power LED on the probe should light.

Amplitude Accuracy

1. Set the volts/division on channel 2 of the oscilloscope to 2 V.
 - Trigger on channel 2.
 - Select 1 M Ω impedance (if option exists on oscilloscope).
 - Connect coaxial cable between TRIG OUT of the generator (rear of Wavetek 9100) and channel 2 of the oscilloscope.
2. Set the volts/division on channel 1 of the oscilloscope to 20 mV.
3. Set the seconds/div to 200 μ s and the acquisition mode to average 32.
4. Connect the coaxial cable from SIG OUT of the generator (rear of Wavetek 9100) to channel 1 of the oscilloscope.
5. Set the generator to 0.1 V and 1 kHz (AUX, square wave, 1 M Ω load). Enable the output.
6. Select the amplitude measurement on the oscilloscope and record the DC amplitude (\sim 100 mV) of square wave. This measurement is the just oscilloscope.
7. Disable the generator output. Disconnect the coaxial cable from channel 1 of the oscilloscope and SIG OUT of the generator.
8. Connect the output of the probe to channel 1 of the oscilloscope.
9. Attach the Modified BNC adapter to the SIG OUT of the generator.
10. Attach the differential probe input leads (without attachment accessories) by sliding the banana plug of the leads onto the binding posts of the Modified BNC adapter, as shown in Figure 8 on page 29.

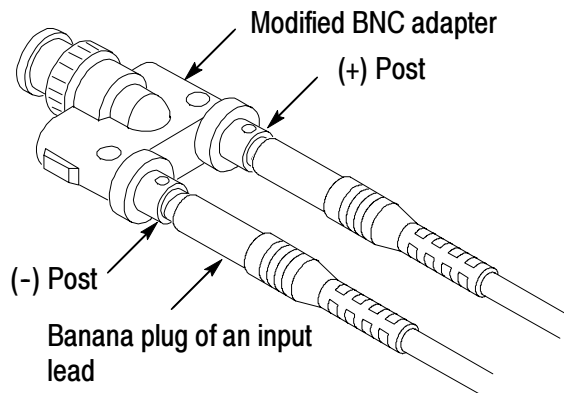

Figure 8: Slide probe leads onto the binding posts



WARNING. To reduce the risk of shock, ensure the generator output is disabled before setting the voltage above 30Vrms.

11. Set the probe range button on the probe to $1/500$ (out). Set the generator for a 50 V and 1 kHz standard amplitude (AUX, Square wave, 1 M Ω load) output. For more details, refer to the *Range Button* description on page 3 of the *Features and Accessories* section.



WARNING. Generator produces hazardous voltage. To avoid risk of shock, do not touch exposed metal parts after the generator output is enabled.

12. Enable the output of the generator.
13. Record the DC amplitude of the square wave. Divide into the amplitude of just the oscilloscope (refer to step 6). Verify that only the probe gain accuracy is $\pm 3\%$.
14. Set the calibration generator for 5 V standard amplitude (square wave) output. Set the probe range button on the probe to $1/50$ (in).
15. Record the DC amplitude of the square wave. Divide into the amplitude of the oscilloscope (refer to step 6). Verify that only the probe gain accuracy is $\pm 3\%$.

16. Reduce the amplitude on the generator to minimum, then disable the generator output and disconnect the setup.

Rise Time

1. Configure the fast rise output of the generator for a 50 Ω load (AUX, rise, 50 Ω load, rising edge).



WARNING. *Generator produces hazardous voltage. To avoid risk of shock, do not touch exposed metal parts after the generator output is enabled.*

2. Attach a 50 Ω terminator to the generator fast-rise output and attach the modified BNC adapter to the terminator.
3. Set the generator for fast rise (< 3 ns), 100 kHz, 1 V.
4. Set the oscilloscope vertical to 5 mV/div and the horizontal to 20 ns/div or 25 ms/div, depending on the slope).
5. Set the probe range to $1/50$ (in).
6. Attach the differential probe input leads (without attachment accessories) by sliding the banana plug of the leads onto the binding posts metal sleeves on the modified BNC adapter. Refer to Figure 8 on page 29. Enable the output of the generator.
7. Check that the rise time is < 14 ns between the 10% and 90% points of the displayed pulse.
8. Reduce the amplitude on the generator to minimum, then disable the generator output and disconnect the setup.

DC CMRR

1. Set the range of the probe to $1/50$.
2. Set the oscilloscope input coupling to DC, the vertical to 50 mV/div, and the seconds/div to 200 μ s. Center the trace on the display. Set the acquisition mode to average 32.
3. Attach the BNC-female-to-dual-banana adapter to the DC output of the generator (front of Wavetek 9100). Attach the modified BNC adapter to the BNC-female-to-dual-banana adapter.
4. Attach the plunger clamps on the differential probe input leads.
5. Twist the input leads together as shown in Figure 4 on page 12, and connect both probe inputs to the positive terminal of the modified BNC adapter.



WARNING. *Generator produces hazardous voltage. To avoid risk of shock, do not touch exposed metal parts after the generator output is enabled.*

6. Set the output of the calibrator to 500 V, and enable the output.
7. Check that the trace on the oscilloscope shifts less than 3.33 divisions (167 mV) from center.



WARNING. *To reduce risk of electrical shock, ensure the generator is disabled before modifying/disconnecting test setup or connections since the exposed metal may be at a hazardous potential. It is recommended that the generator output amplitude be reduced to a minimum prior to disabling the output.*

8. Disable the calibrator output, and disconnect all test equipment.
This completes the performance verification procedure.

Replaceable Parts

This section contains a list of the replaceable modules for the P5200 High Voltage Differential Probe. Use this list to identify and order replacement parts.

Parts Ordering Information

Replacement parts are available through your local Tektronix field office or representative.

Changes to Tektronix instruments are sometimes made to accommodate improved components as they become available and to give you the benefit of the latest circuit improvements. Therefore, when ordering parts, it is important to include the following information in your order:

- Part number
- Instrument type or model number
- Instrument serial number
- Instrument modification number, if applicable

If you order a part that has been replaced with a different or improved part, your local Tektronix field office or representative will contact you concerning any change in part number.

Change information, if any, is located at the rear of this manual.

Module Exchange

You may exchange your module for a remanufactured module. These modules cost significantly less than new modules and meet the same factory specifications. For more information about the module exchange program, refer to *Contacting Tektronix*, on page vi.

Using the Replaceable Parts List

This section contains a list of the mechanical and/or electrical components that are replaceable for the P5200 probe. Use this list to identify and order replacement parts. Table 8 describes each column in the parts list.

Table 8: Parts List Column Descriptions

Column	Column Name	Description
1	Figure & Index Number	Items in this section are referenced by figure and index numbers to the exploded view illustrations that follow.
2	Tektronix Part Number	Use this part number when ordering replacement parts from Tektronix.
3 and 4	Serial Number	Column three indicates the serial number at which the part was first effective. Column four indicates the serial number at which the part was discontinued. No entries indicates the part is good for all serial numbers.
5	Qty	This indicates the quantity of parts used.
6	Name & Description	An item name is separated from the description by a colon (:). Because of space limitations, an item name may sometimes appear as incomplete. Use the U.S. Federal Catalog handbook H6-1 for further item name identification.
7	Mfr. Code	This indicates the code of the actual manufacturer of the part.
8	Mfr. Part Number	This indicates the actual manufacturer's or vendor's part number.

Abbreviations

Abbreviations conform to American National Standard ANSI Y1.1-1972.

Mfr. Code to Manufacturer Cross Index

The table titled Cross Index - Mfr.Code Number to Manufacturer shows codes, names, and addresses of manufacturers or vendors of components listed in the parts list.

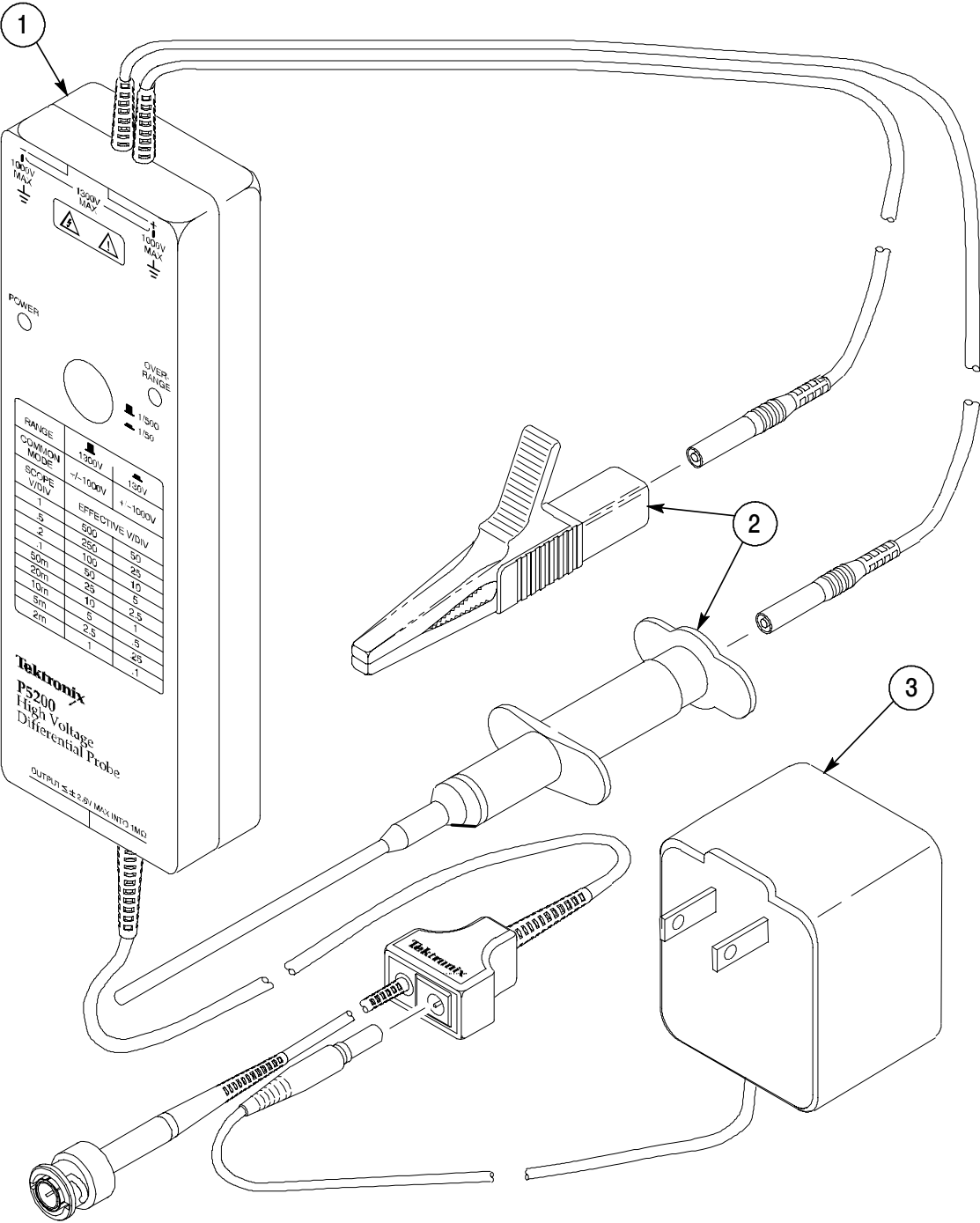

Figure 9: P5200 High Voltage Differential Probe and replaceable accessories

Fig. & Index No.	Tektronix Part No.	Serial No. Effective Discount	Qty	12345 Name & Description	Mfr. Code	Mfr. Part No.
9-1	119-4784-00		1	PROBE,DIF ACT:POWER,1KV,25 MHZ	80009	119478400
STANDARD ACCESSORIES						
-2	020-2106-00		1	ACCESS PKG:(1) RED,(1) BLACK CROCODILE CLIP& (1) RED, (1) BLACK INSULATED PLUNGER CLAMP CLIP,COMPONENT KIT	80009	020210600
-3	119-3306-00		1	POWER SUPPLY:4.5W;9V 500MA, UNREGULATED, 120VAC 60HZ, 183CM CABLE W/5.5MM OD,2.1MM ID COAX PLUG (UNITED STATES)	80009	119330600
	119-4240-00		1	POWER SUPPLY:PLUG-IN WALL MOUNT,IN 220VAC,EUROPEAN TYPE,OUT 9VDC 1A,W/6FT CABLE,W/2 POLE POWER PLUG CONN,VDE APPROVED (OPTIONS A1 & A5)	80009	119424000
	119-4239-00		1	POWER SUPPLY:PLUG-IN WALL MOUNT,IN 240VAC,UK TYPE,OUT 9VDC 1A,W/6FT CABLE,W/2 POLE POWER PLUG CONN,BSI APPROVED (OPTION A2)	80009	119423900
	119-4238-00		1	POWER SUPPLY:PLUG-IN WALL MOUNT,IN 240VAC,AUSTRALIA TYPE,OUT 9VDC1A,W/6FT CABLE,W/2 POLE POWER PLUG CONN,SAA APPROVED (OPTION A3)	80009	119423800
	119-4241-00		1	POWER SUPPLY:PLUG-IN WALL MOUNT,IN 100VAC,JAPAN TYPE,OUT 9VDC 1A,W/6 FT CABLE,W/2 POLE POWER PLUG CONN,MITI APPROVED (OPTION A6)	80009	119424100
	070-9018-XX		1	MANUAL,TECH:INSTRUCTIONS,P5200,DP	80009	0709018XX

CROSS INDEX - MFR. CODE NUMBER TO MANUFACTURER

Mfr. Code	Manufacturer	Address	City, State, Zip Code
80009	TEKTRONIX INC	14150 SW KARL BRAUN DR PO BOX 500	BEAVERTON OR 97077-0001