



ABN 43 064 478 842

231 Osborne Avenue Clayton South, VIC 3169
PO Box 1548, Clayton South, VIC 3169
t 03 9265 7400 f 03 9558 0875
freecall 1800 680 680
www.tmgtestequipment.com.au

Test & Measurement

- > sales
- > rentals
- > calibration
- > repair
- > disposal

Complimentary Reference Material

This PDF has been made available as a complimentary service for you to assist in evaluating this model for your testing requirements.

TMG offers a wide range of test equipment solutions, from renting short to long term, buying refurbished and purchasing new. Financing options, such as Financial Rental, and Leasing are also available on application.

TMG will assist if you are unsure whether this model will suit your requirements.

Call TMG if you need to organise repair and/or calibrate your unit.

If you click on the "Click-to-Call" logo below, you can call us for FREE!

TMG Corporate Website

TMG Products Website



Click-to-Call
TMG Now



Product Lifecycle Management System

Disclaimer:

All trademarks appearing within this PDF are trademarks of their respective owners.



ETK240106D

OPTICAL FIBER FUSION SPLICER
SUMITOMO TYPE-35SE
OPERATION MANUAL

 SUMITOMO ELECTRIC INDUSTRIES, LTD.

Contents

	Page
1. General	1
1-1 Outline.....	1
1-2 Special Terms.....	2
1-3 Specifications.....	4
1-4 Precautions.....	5
2. Configuration and Structure	6
2-1 Configuration.....	6
2-2 Structure.....	7
2-3 Panel's Function.....	8
3. Preparation for Operation	10
3-1 Connecting the AC Power Cord.....	10
3-2 Connecting the DC Power Cord.....	11
3-3 Setting Splice Mode.....	12
4. Operation	16
4-1 Fiber Clamping.....	16
4-2 Arc Fusion Condition Test.....	18
4-3 Automatic Splicing.....	21
4-4 Flow Chart of Operation.....	23
4-5 Evaluation of the Splice.....	26
4-6 Reinforcement.....	28
4-7 END Operation.....	32
5. Storage and Transportation	33
6. Counter Action to Faulty Motion	34
Appendix	
A-1 Principle of DCM (Direct Core Monitoring)	36
A-2 Arc Fusion Condition Parameter	39
A-3 Mode Function And Use Method	40
A-3-1 Mode Switching Method.....	40
A-3-2 Mode Function Explanation.....	40
A-3-3 Mode Help Screen.....	41
A-3-4 Automatic / Manual Mode Selection	44
A-3-4-1 Condition Setup Screen.....	44
A-3-4-2 Fiber Type Selection Screen	44
A-3-4-3 Arc Condition Display Screen	45
A-3-4-4 Align Method Setup Screen	46
A-3-4-5 Diameter Condition Setup Screen	46

A-3-4-6	Data Display / Storage Setup Screen	47
A-3-4-7	Stored Data Display Screen	48
A-3-4-8	Arc Test Setup Screen	48
A-3-4-9	Date Setup Screen	49
A-3-5	Communication Mode Selection	49
A-3-6	Parameter Mode Selection	50
A-3-6-1	Parameter Setup Screen	50
A-3-6-2	Read Parameter Screen	50
A-3-6-3	Write Parameter Screen	51
A-3-7	Maintenance Mode Selection	51
A-3-7-1	Maintenance Screen	51
A-3-7-2	Motor Drive Test Setup Screen	52
A-3-7-3	Motor Drive Test Screen	52
A-3-7-4	Electrode Inferiority Test Setup Screen	53
A-3-7-5	Warm-up Screen	54
A-3-7-6	Electrode Abrasion Check Screen	54
A-3-7-7	Electrode and Fiber Lines Display Screen	55
A-3-7-8	Arc Counter Initialization Screen	55
A-3-8	Fiber Name Mode Selection	56
A-3-9	Heater Setup Mode Selection	57
A-3-9-1	Heater Condition Setup Screen	57
A-3-9-2	Heater Condition Display Screen	57
A-3-10	Manual Mode Operation Procedures	58
A-3-11	Step Mode Operation Procedures	59
A-4	Parameter List	60
A-5	RS232C Interface	67
A-6	Primary Maintenance	68
A-6-1	Cleaning the V-groove and bare fiber clamp	68
A-6-2	Cleaning the Mirror	69
A-6-3	Cleaning the Objective Lens	70
A-6-4	Cleaning LED	70
A-6-5	Replacement of electrode	71
A-7	Error Message List	72

1. General

1-1 Outline

This manual presents the operation of the SUMITOMO TYPE-35SE fusion splicer. The TYPE-35SE fusion splicer is used for splicing silica-glass optical fibers (outer diameter: 80 to 150 μm) which have been stripped and cleaved.

It operates using 85 to 265 VAC or 12 (11 to 14.5) VDC. The table below shows the fiber requirement for the TYPE-35SE.

Table 1-1-A: Fiber Requirement

Items	Description
Material	Silica-glass
Cladding dia. [μm]	80 to 150
Core dia. of single mode fiber [μm]	4 to 14
Cleave length [mm] (length of bare fiber)	16 ± 0.5 (Standard) $9 \pm 0.5, 4 \pm 0.5$ (Option)

1-2 Special Terms

Table 1-2-A

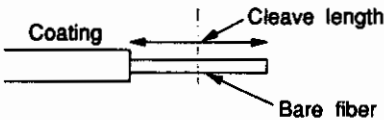
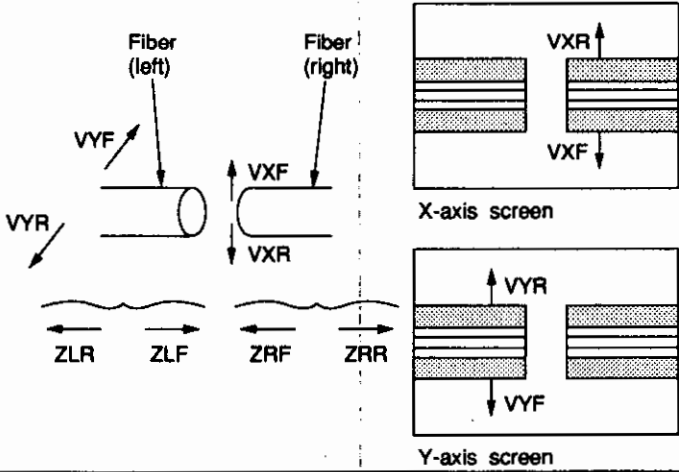
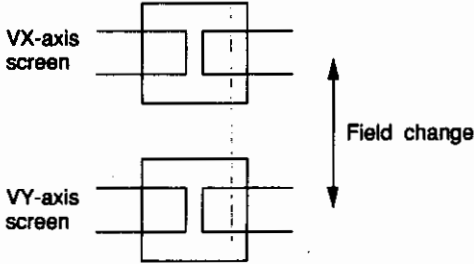
ITEM	Term	Description
Fiber	SM MM	Single Mode Multi mode
	CCITT	Consultive Committee International Telephone and Telegraph
	Cleave Length	Bare fiber length after cleaving 
	Standard SM fiber Standard DS fiber Standard MM fiber	SM fiber specified by CCITT G652. DS fiber specified by CCITT G653. MM fiber specified by CCITT G651.
Splicer	Estimated Splice Loss	The splice loss calculated from fiber core offset and core deformation of spliced portion (HDCM).
	HDCM X, Y, Z axes VX } V-groove VY } movement axis for alignment Z fiber feed axis	High resolution Direct Core Monitoring 
	VX-axis screen VY-axis screen	Identification of two orthogonal observation screens 

ITEM	Term	Description
Splicer	<p>"RETURN ORIGIN" Motion</p> <p>TYPE-35SE-SPH</p>	<p>Setting the status of splicer to initial condition (including software and mechanical system)</p> <p>Standard configuration of TYPE-35SE with integrated Splice Protection Sleeve Heater.</p>
Others	<p>FPS-01</p> <p>HHC-35SE</p> <p>RS-C</p> <p>CBU-02</p> <p>PC-C</p>	<p>Fiber Protection Sleeve</p> <div data-bbox="790 638 1260 907" data-label="Diagram"> <p>The diagram illustrates the Fiber Protection Sleeve assembly. It consists of a stainless steel rod passing through the center of a heat-shrinkable tube. A heat adhesive tube is applied to the end of the sleeve. A dimension line indicates a length of 60mm for the sleeve section.</p> </div> <p>Hand-Held Computer</p> <p>RS232C cord for HHC-35SE (D-Sub 9 pin to DB-25M)</p> <p>Car Battery Unit adaptor</p> <p>DC power cord for TYPE-35SE</p>

1-3 Specifications

- Fiber Requirements

Material	Silica glass
Type	Single Mode, or Multi Mode
Cladding diameter	80 to 150 μ m
Cleave length	16 \pm 0.5 mm to (9 mm, 4 mm : option)
Coating diameter	Less than 1.5 mm

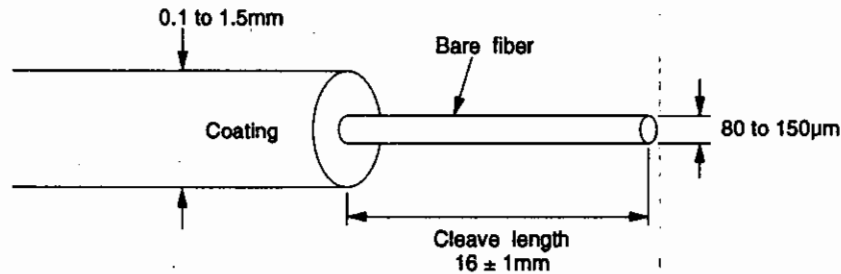

Fig. 1-3-A

- Physical Characteristics

Size	220 W \times 210 H \times 235 D (mm) 8.7 W \times 8.3 H \times 9.3 D (Inch)
Weight	Approx. 10 kg (22 lb)
Display size	76 mm (3.0 inch) diagonal

- Power Requirements

Input	85 to 265 VAC at 50 to 60 Hz 11 to 14.5 VDC
-------	--

- Environmental Condition

Operation temperature	0 ~ 40 $^{\circ}$ C (32 ~ 104 $^{\circ}$ F)
Operation humidity	95%RH, non-condensing
Storage temperature	-40 to 66 $^{\circ}$ C (-40 to 150 $^{\circ}$ F)
Storage humidity	non-condensing

- Typical Performance

Average splice loss	0.03 dB (Identical SM) 0.05 dB (Identical DS) 0.02 dB (Identical MM)
Typical cycling time	45 sec.

- External Connectors

Data communications	RS232C, D-sub-9 style jack
DC power output	12 VDC, for SUMITOMO accessories
Video output	NTSC base band signal, BNC style jack

- Programs

Fusion Condition	21 selectable setting
------------------	-----------------------

1-4 Precautions

- (1) Never touch the electrode because a high voltage of approximately 6,000 V is generated at the beginning of fusion.
- (2) Make sure to ground the main body during use.
- (3) Make sure that the splicer is completely dry before using. If the main body of the splicer is wet, dry it with a hair drier, etc.
- (4) Do not lubricate any part of this equipment.
- (5) Do not use Freon gas because it may produce harmful gas by the discharge, and may result in a defective fusion.
- (6) Since the fusion splicer is a precision instrument, protect it against dust, dirt, grit and moisture.
- (7) If dust is on the objective lens or mirror, clean the lens or mirror carefully with a cotton swab soaked with alcohol so as not to scratch its surface. (Then use a dry swab to prevent spotting on the lens or mirror.)
- (8) It is recommended that inspections be performed before and after continuous usage and an annual maintenance be performed.
- (9) Do not use a generator without a regulator in order to prevent a damage on the power supply unit in the T-35SE.

2. Configuration and Structure

2-1 Configuration

The table below shows the configuration of the TYPE-35SE-SPH fusion splicer set.

Table 2-1-A: Configuration of TYPE-35SE-SPH

No.	Item [Parts #]	Q'ty	Description
1	Fusion Splicer Main Body	1 unit	With Internal AC/DC converter Internal LCD Video monitor and Protection sleeve Heater
2	AC Power Cord [PC-AC]	1 pc	With adaptor plug
3	Carrying Case [CC-35SE]	1 pc	With shoulder strap
4	Spare Parts		
	Fusion Electrode [ER-2]	1 pairs	
5	Operation Manual	1 copy	

2-2 Structure

(1) Main Body

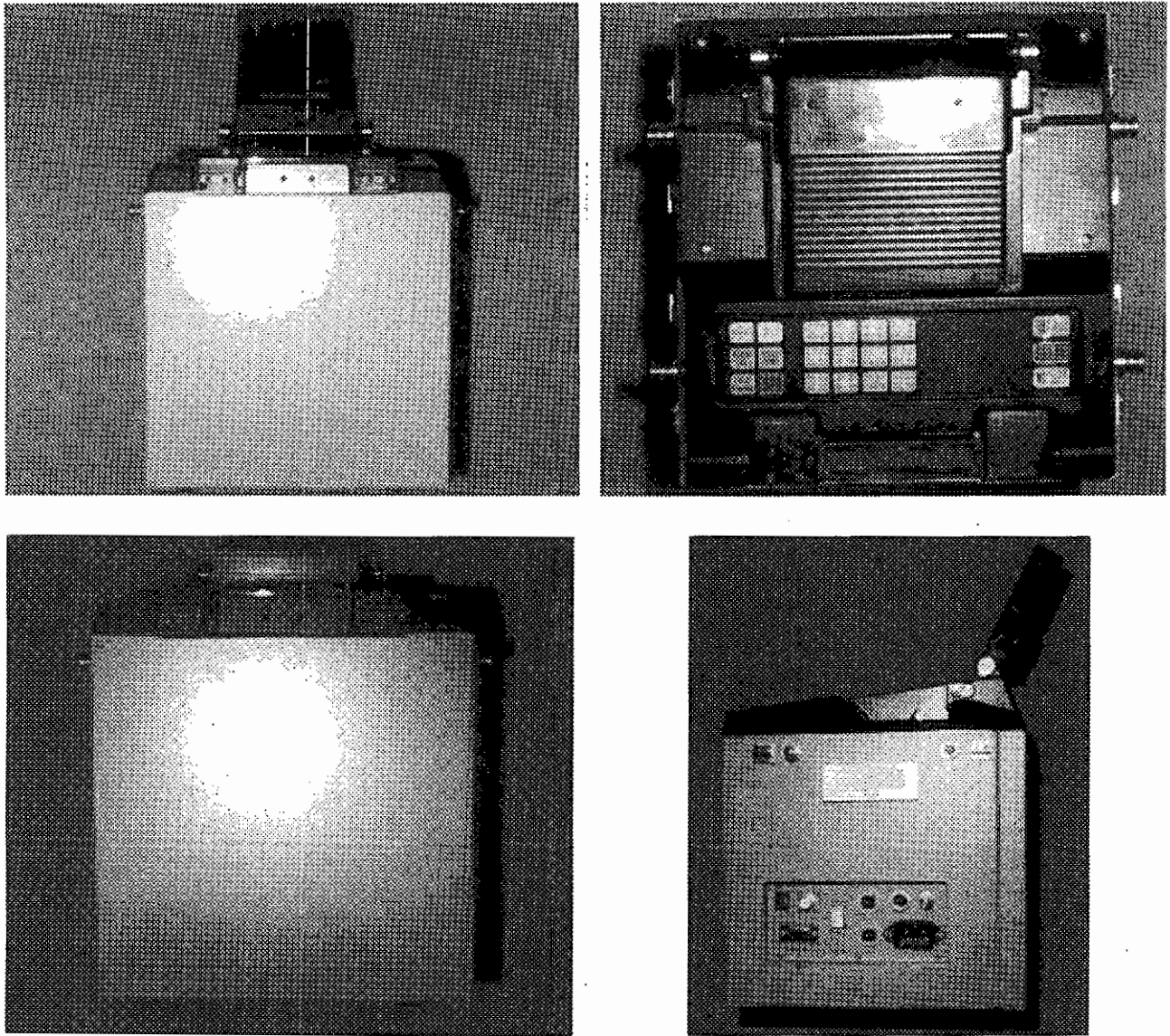

Fig. 2-2-A

(2) AC Power Cord

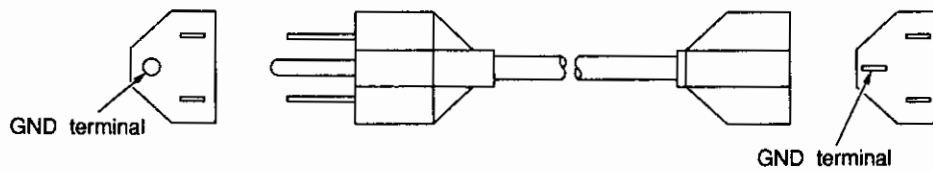

Fig. 2-2-B

(3) Fusion Electrode [ER-2]

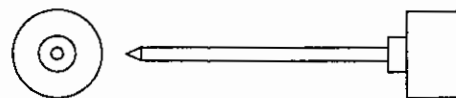

Fig. 2-2-C

2-3 Panel's Function

(1) Top Mounted Console Panel

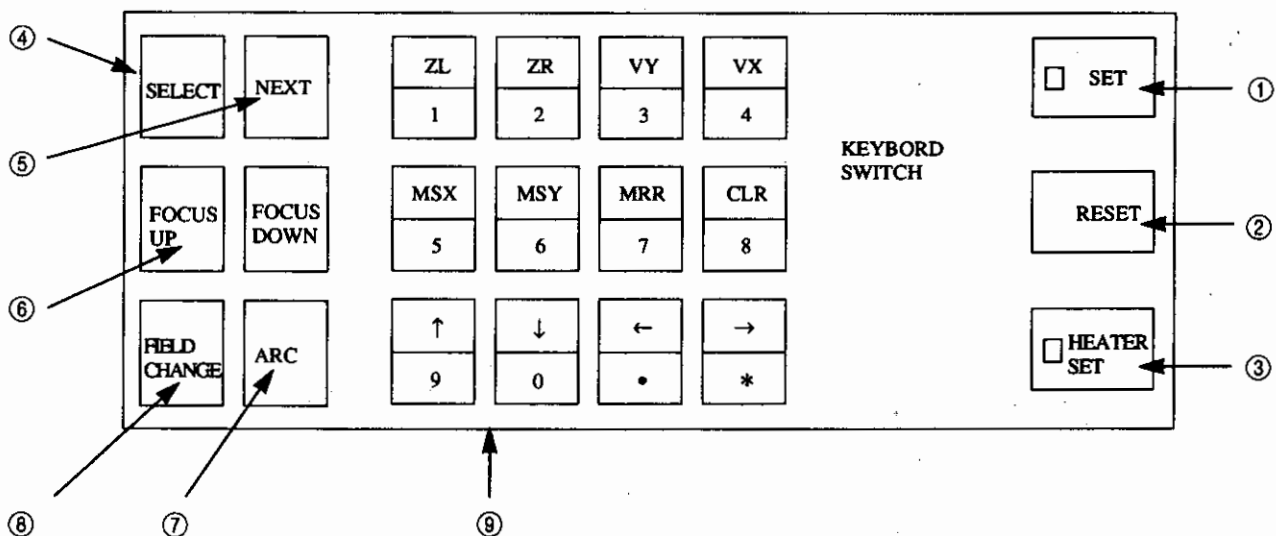

Fig. 2-3-A: Top Mounted Console Panel

Table 2-3-A: Function of Switches (SW)

Switch	Description
① SET	This SW initiates automatic operation.
② RESET	This SW returns the status of splicer to initial condition, or stops the process of splicer.
③ HEATER SET	This SW with the working indicator lamp initiates the reinforcement process.
④ SELECT	This SW activates the menu item marked by *.
⑤ NEXT	In the menu screen, this SW moves the (*) mark to next position.
⑥ FOCUS { UP DOWN	These SW change the focus of the image.
⑦ ARC	This SW activates the refusion arc.
⑧ FIELD CHANGE	This SW changes the screen X → Y, or Y → X.
⑨ KEYBOARD SWITCH	This switch enables the manual operation of function selection, parameter setting, etc. in each mode.

(2) Input/Output Panel

Input/Output panel is located on the right-hand side of the main body.

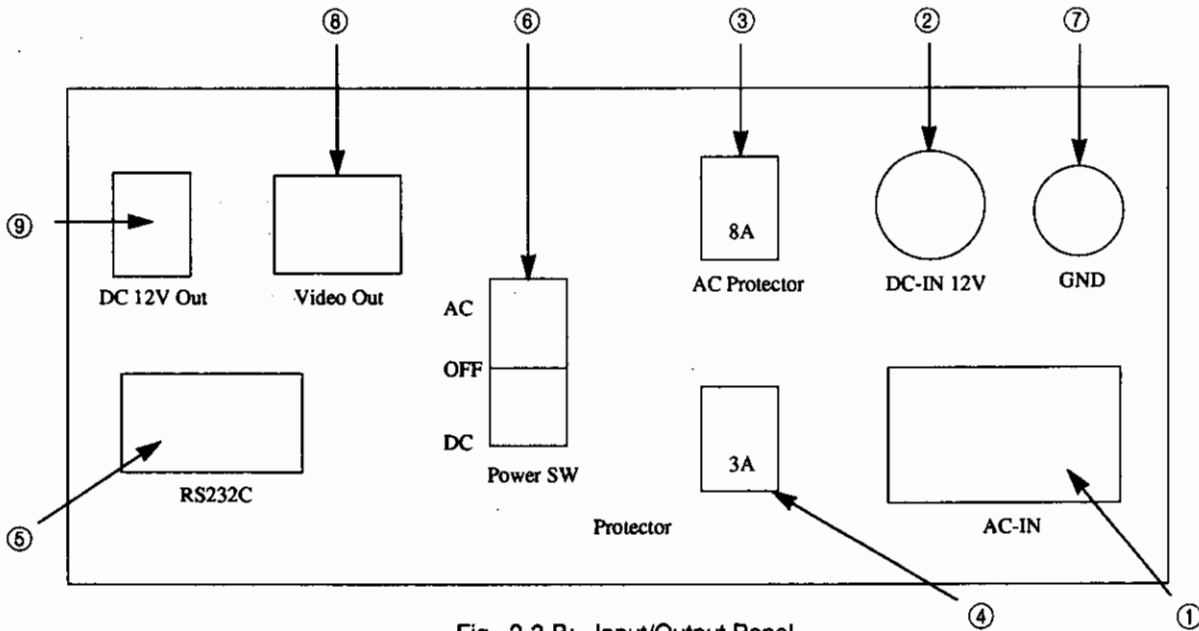

Fig. 2-3-B: Input/Output Panel

Table 2-3-B

No.	Items	Description
①	AC-IN	This terminal is used to connect the fusion splicer with an AC power source.
②	DC-IN 12V	This terminal is used to connect the fusion splicer with a DC power source.
③	AC Protector	Circuit breaker — push to reset.
④	DC Protector	Circuit breaker — push to reset.
⑤	RS232C	This terminal is used to connect the fusion splicer with an external computer for serial data communication. Through this connection, remote control and internal parameter setting of the fusion splicer can be performed.
⑥	Power SW	This SW select "POWER OFF", "AC POWER ON" and "DC POWER ON" by pressing it. "POWER OFF" : Center position "AC POWER ON" : Upper position "DC POWER ON" : Lower position
⑦	GND	This is the ground terminal for the fusion splicer.
⑧	Video Out	The base band video signal (NTSC) is output from this terminal with a BNC type connector. This terminal is used to observe splicing motion by an external video monitor, and can also be connected to a video copy printer for printing the screen display.
⑨	DC 12V Out	This terminal is used to supply 12V DC to other accessories.

3. Preparation for Operation

3-1 Connecting the AC Power Cord

- (1) Connect the AC power cord (PC-AC) to AC POWER IN of main body and then insert the plug into an electrical outlet.

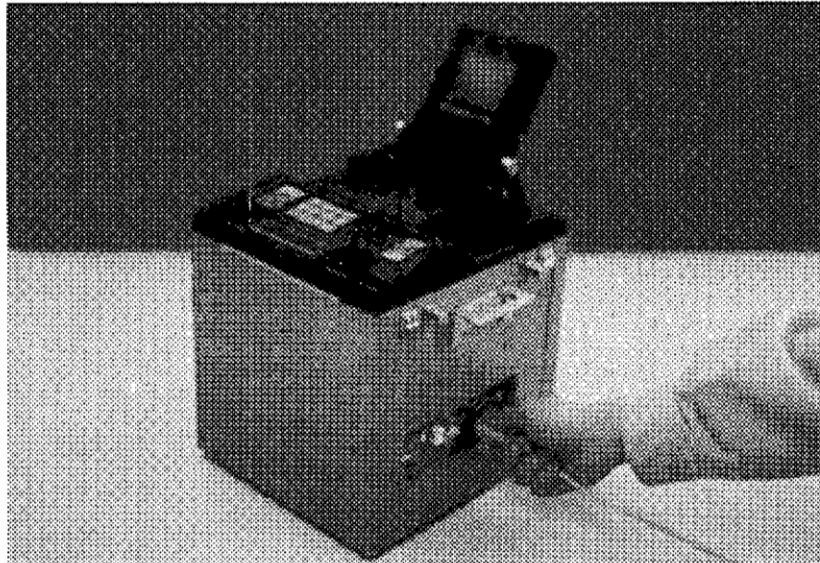

Fig. 3-1-A

- (2) Ground the GND terminal. Make sure the splicer is grounded.

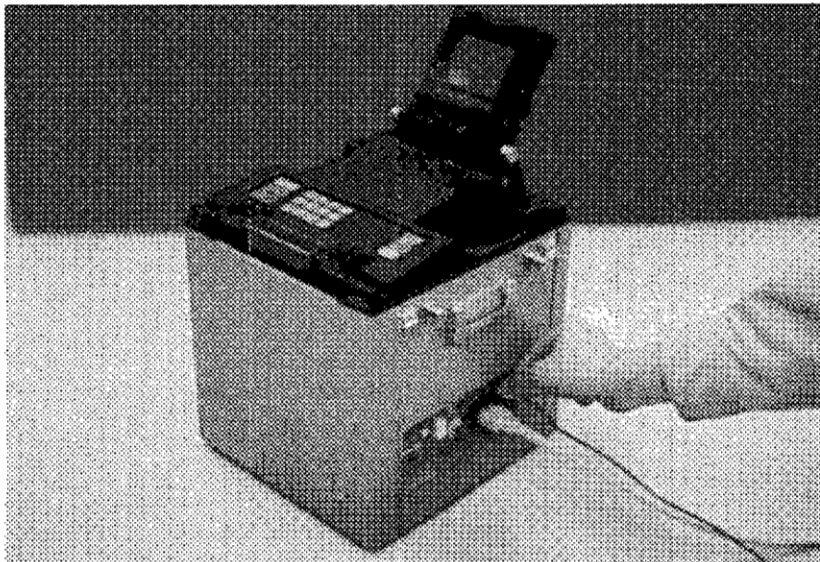

Fig. 3-1-B

- (3) Press the upper part (AC side) of the power switch for AC input.



Fig. 3-1-C

3-2 Connecting the DC Power Cord

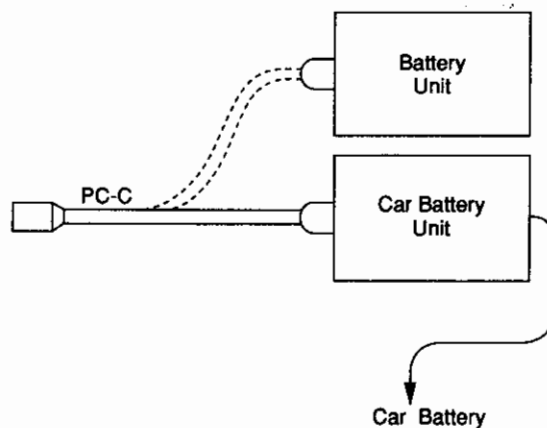
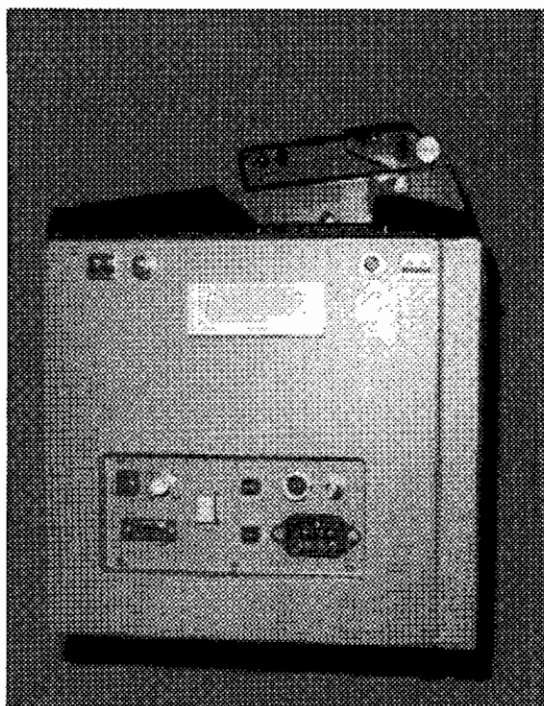

Fig. 3-2-A

- (1) Connect DC power cord (PC-C) to DC-IN of main body and connect the other end of PC-C to CBU-02 which is connected to Car Battery or battery unit.
- (2) Press the lower part (DC side) of the power SW for DC input.



Fig. 3-2-B

3-3 Setting Splice Mode

(1) General

The screen shows the following menu, after the set-up of the splicer. If the screen shows a different menu, press "RESET" SW of TOP mounted control panel.

```
SETTING CONDITION
(AUTOMATIC MODE)
1  PROFILE TYPE
   SM FIBER STD
2  ALIGN METHOD
   CORE
3  DIAMETER
   SIMILAR
4  DATA MEMORY
   NONE STORE
5  ARC TEST (N O)
6  TIME

RESET COMPLETE
```

Fig. 3-3-A

- Arc condition

21 types of arc condition such as standard SM fiber, standard MM fiber, etc., can be stored in the memory and selected for splicing fibers.

The arc condition consists of 5 fusion conditions such as arc power, fusion duration etc.

The TYPE-35SE memorizes the arc conditions for the standard SM fibers and standard MM fibers at shipment, which are specified by CCITT G652, G651.

- Profile type

The profile type designates inspection methods for SM fiber, dispersion shifted SM fiber or MM fiber.

- Alignment method

The alignment method indicates core alignment, diameter alignment, or "Intentional Axis Shift" (IAS).

- Diameter

Diameter designates whether the outside diameters of the right and left fibers are "SIMILAR" or "DISSIMILAR" according to the following:

SIMILAR: Diameter difference between both fibers is within 6 μm .

DISSIMILAR: Diameter difference between both fibers is more than 6 μm .

(2) Setting Splice Mode for Standard Single Mode Fiber

The splice mode for splicing of the standard SM fibers, should be set to the following menu on the screen.

```
SETTING CONDITION
(AUTOMATIC MODE)
1  PROFILE TYPE
   SM FIBER STD
2  ALIGN METHOD
   CORE
3  DIAMETER
   SIMILAR
4  DATA MEMORY
   NONE STORE
5  ARC TEST (N O)
6  TIME
RESET COMPLETE
```

Fig. 3-3-B

If the screen shows a different figure, please set FUSION CONDITION as follows:

- (i) Select "PROFILE TYPE" by pressing "1" and then "SELECT" SW. PROFILE TYPE menu will be on screen as shown in Fig. 3-3-C.
- (ii) Set "*" mark to "1" by pressing "1" SW. Then press "SELECT" SW, and Fig. 3-3-D menu appears on the screen.

```
PROFILE TYPE
* 1  SM FIBER
   2  MM FIBER
   3  DSM FIBER
SW : SEL/NEXT/KEY
```

Fig. 3-3-C

```
PROFILE TYPE DETAIL
* 1  SM FIBER STD
   2  OTHER 1
   3  OTHER 2
   4  OTHER 3
   5  OTHER 4
   5  OTHER 5
   7  OTHER 6
SW : SEL/NEXT/KEY
```

Fig. 3-3-D

(iii) Set "*" mark to "SM FIBER (STD)" by pressing "1" SW, as shown in the above figure.

(iv) Press "SELECT" SW, and then the following menu appears on the screen.

Press "NEXT" SW again; and the screen shows the initial menu, as shown in Fig. 3-3-B.

```
ARC CONDITION
* 1 FUSION DURATION
  [001] 01.50 (sec)
  2 PREFUSION
  [002] 00.10 (sec)
  3 ARC GAP
  [003] 10.00 (um)
  4 OVERLAP
  [004] 15.00 (um)
  5 ARC POWER
  [005] 0009 (step)
SW : SEL/NEXT/KEY
```

Fig. 3-3-E

"PROFILE TYPE", "ALIGN METHOD" and "DIAMETER" in the initial menu are set to "SINGLE MODE", "CORE" and "SIMILAR" automatically. If those parameters are required to designate the other functions, please refer to Appendix A-3-4.

(3) Setting Splice Mode for Multi Mode Fiber

The splice mode for splicing of standard MM fibers, should set to the following menu on the screen.

```
SETTING CONDITION
(AUTOMATIC MODE)
1 PROFILE TYPE
  MM FIBER STD
2 ALIGN METHOD
  DIAMETER
3 DIAMETER
  SIMILAR
4 DATA MEMORY
  NONE STORE
5 ARC TEST (N O)
6 TIME
RESET COMPLETE
```

Fig. 3-3-F

If the screen shows a different figure, please set FUSION CONDITION as follows:

- (i) Select "PROFILE TYPE" by pressing "1".
- (ii) Set "*" mark to "2" by pressing "2" SW. PROFILE TYPE menu will be on screen as shown in Fig. 3-3-G. Then press "SELECT".

```
PROFILE TYPE
  1 SM FIBER
 * 2 MM FIBER
  3 DSM FIBER

SW : SEL/NEXT/KEY
```

Fig. 3-3-G

- (iii) And then the following menu appears on the screen.

Press "NEXT" SW, and the screen will show the initial menu, as shown in Fig. 3-3-F.

```
ARC CONDITION
 * 1 FUSION DURATION
    [036] 04.50 (sec)
  2 PREFUSION
    [037] 00.15 (sec)
  3 ARC GAP
    [038] 10.00 (um)
  4 OVERLAP
    [039] 15.00 (um)
  5 ARC POWER
    [040] 0005 (step)

SW : SEL/NEXT/KEY
```

Fig. 3-3-H

"PROFILE TYPE", "ALIGN METHOD" and "DIAMETER" in the initial menu are set to "MULTI MODE", "DIAMETER" and "SIMILAR" automatically. If those parameters are required to designate the other functions, please refer to Appendix A-3-4.

4. Operation

4-1. Fiber Clamping

- 1) Open the hood.
- 2) Release the coating clamp by pulling the clamp lever towards the front of the machine.
- 3) Remove the fiber coating, clean the fiber and then cleave the bare fiber to the predetermined length.

Set the prepared fiber in the V groove as shown in the figure below.

- 4) Clamp the prepared fiber exactly by pushing the clamp lever.
- 5) After clamping the right and left fibers, close the hood. Make sure that the prepared fiber is not trapped by the hood, and not caught by any other part of the machine.

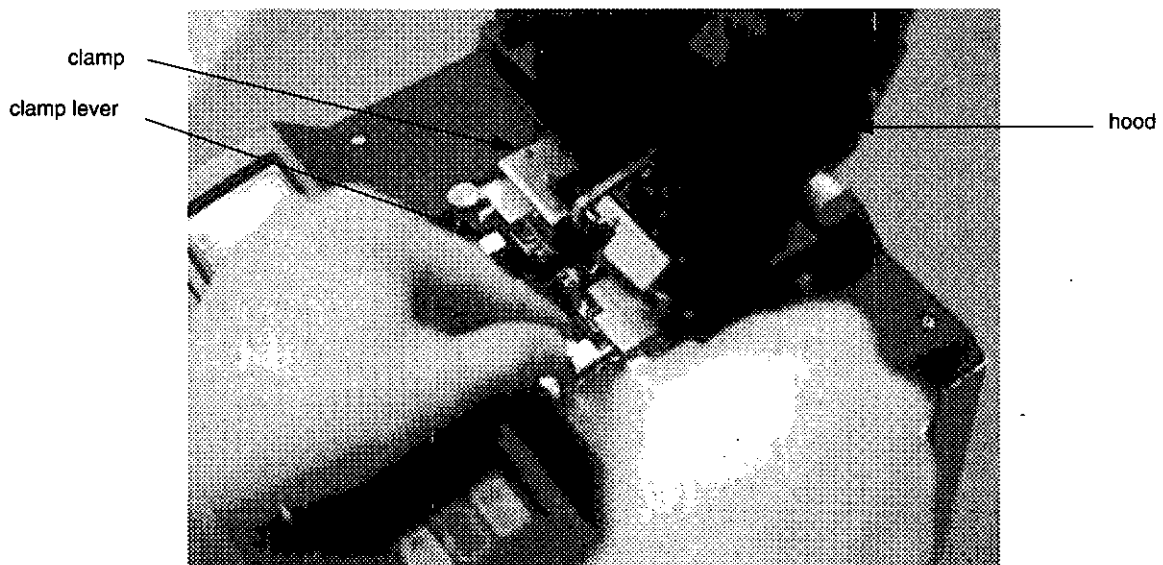

Fig. 4-1

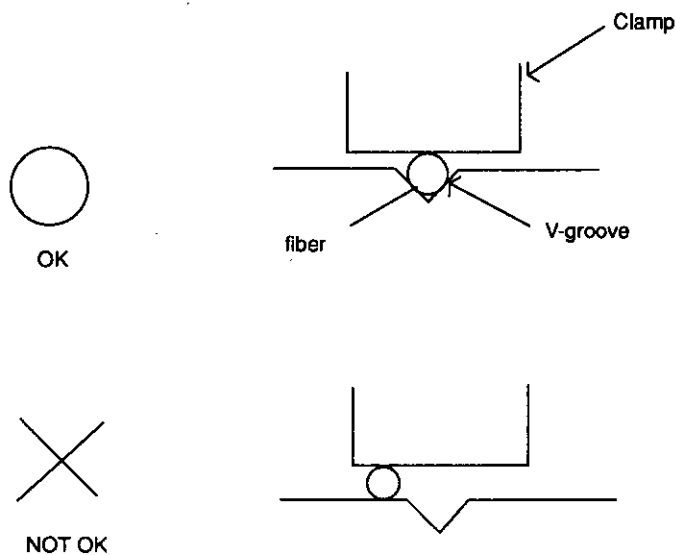

Fig. 4-1-B

Note 1: The end of the fiber jacket should touch to the fiber guide.

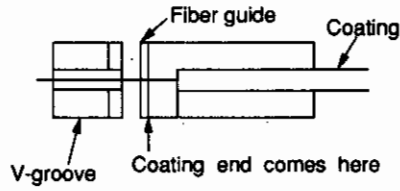

Fig. 4-1-C

Note 2: Do not rub the end of the fiber against the bottom of the V-groove during this process. Fig. 4-1-D shows example of incorrect technique.

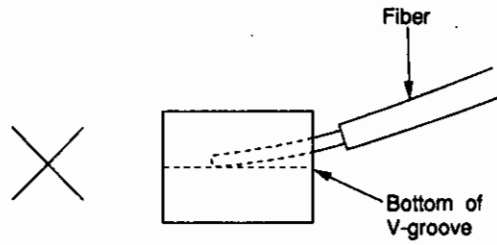

Fig. 4-1-D

4-2 Arc Fusion Condition Test

The arc fusion condition of the fusion splicer is very important for obtaining a low splice loss. The TYPE-35SE can self check the arc fusion condition for all fiber.

(1) Principle

As shown in the following figure, the gap length between the fiber ends before and after arc fusion discharge are L and L' respectively. ΔL is obtained as follows:

$$\Delta L = L' - L$$

By using ΔL , it can judge whether the arc fusion condition is good or not.

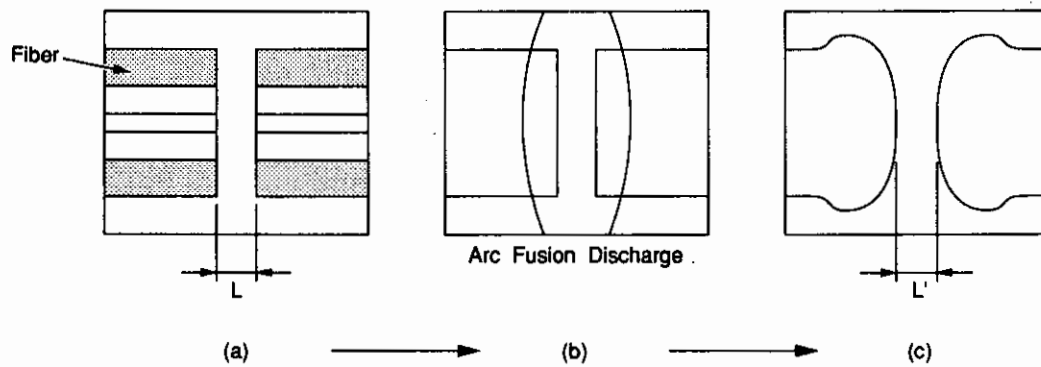

Fig. 4-2-A

(2) Test Procedure

(i) Select "ARC TEST" by pressing the "5" Key.

	SETTING CONDITION (AUTOMATIC MODE)
1	PROFILE TYPE SM FIBER STD
2	ALIGN METHOD CORE
3	DIAMETER SIMILAR
4	DATA MEMORY NONE STORE
5	ARC TEST (N O)
6	TIME
	RESET COMPLETE

Fig. 4-2-B

(ii) Press the "1" Key, as shown in the following menu, and then the "SELECT" SW.

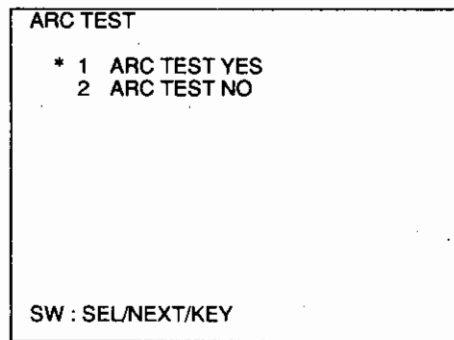

Fig. 4-2-C

(iii) Press the "NEXT" SW again, and then the following menu appears on the screen.

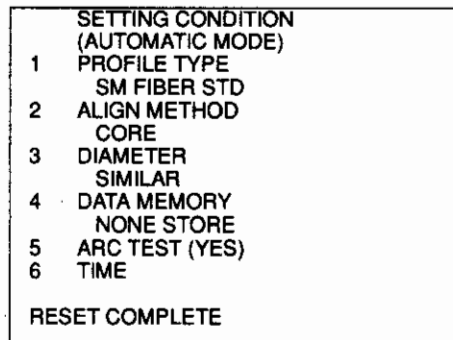
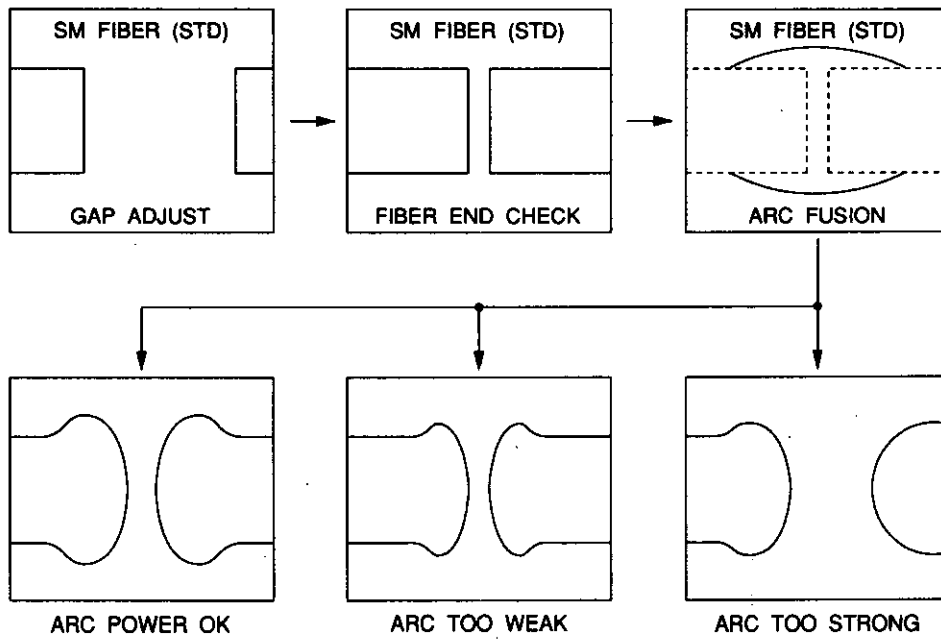

Fig. 4-2-D

Please ensure that ARC TEST (YES) appears.

(iv) Prepare standard SM fiber in the usual manner: remove the coating of the fiber, clean and cleave the fiber. After clamping the prepared fiber to the splicer, press "SET" SW and then "ARC TEST" is performed as follows:



If the arc fusion condition is not OK, "ARC POWER" is automatically adjusted. Repeat this test until "ARC POWER OK" appears.

4-3 Automatic Splicing

After fiber clamping is finished, close hood and press the "SET SW".

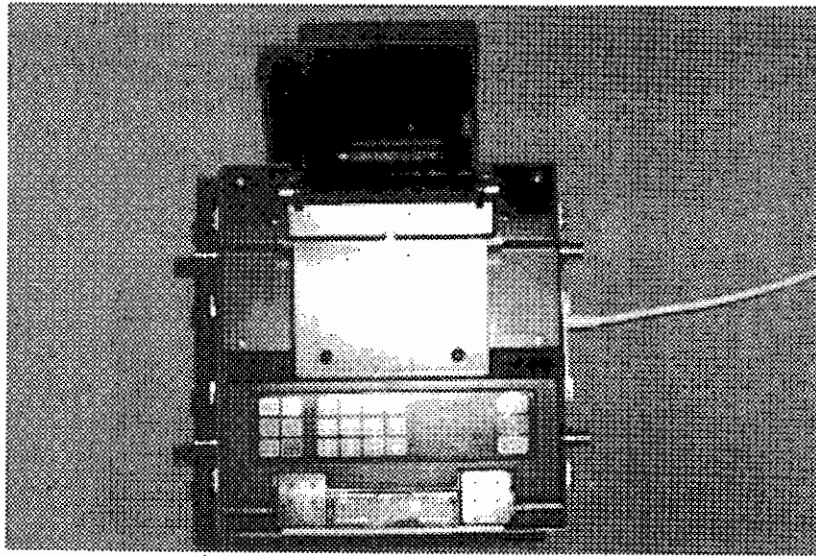

Fig. 4-3-A

All of the splicing processes are performed automatically as shown in the following Flow Chart. The detail of automatic splicing process are presented in tables 4-3. The last screen, if the operation is normal, is as follows:

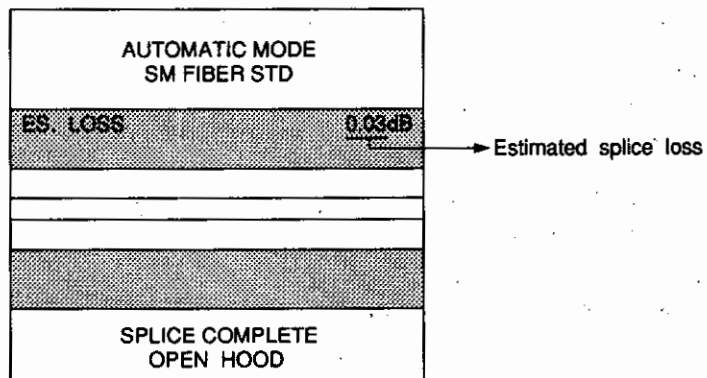
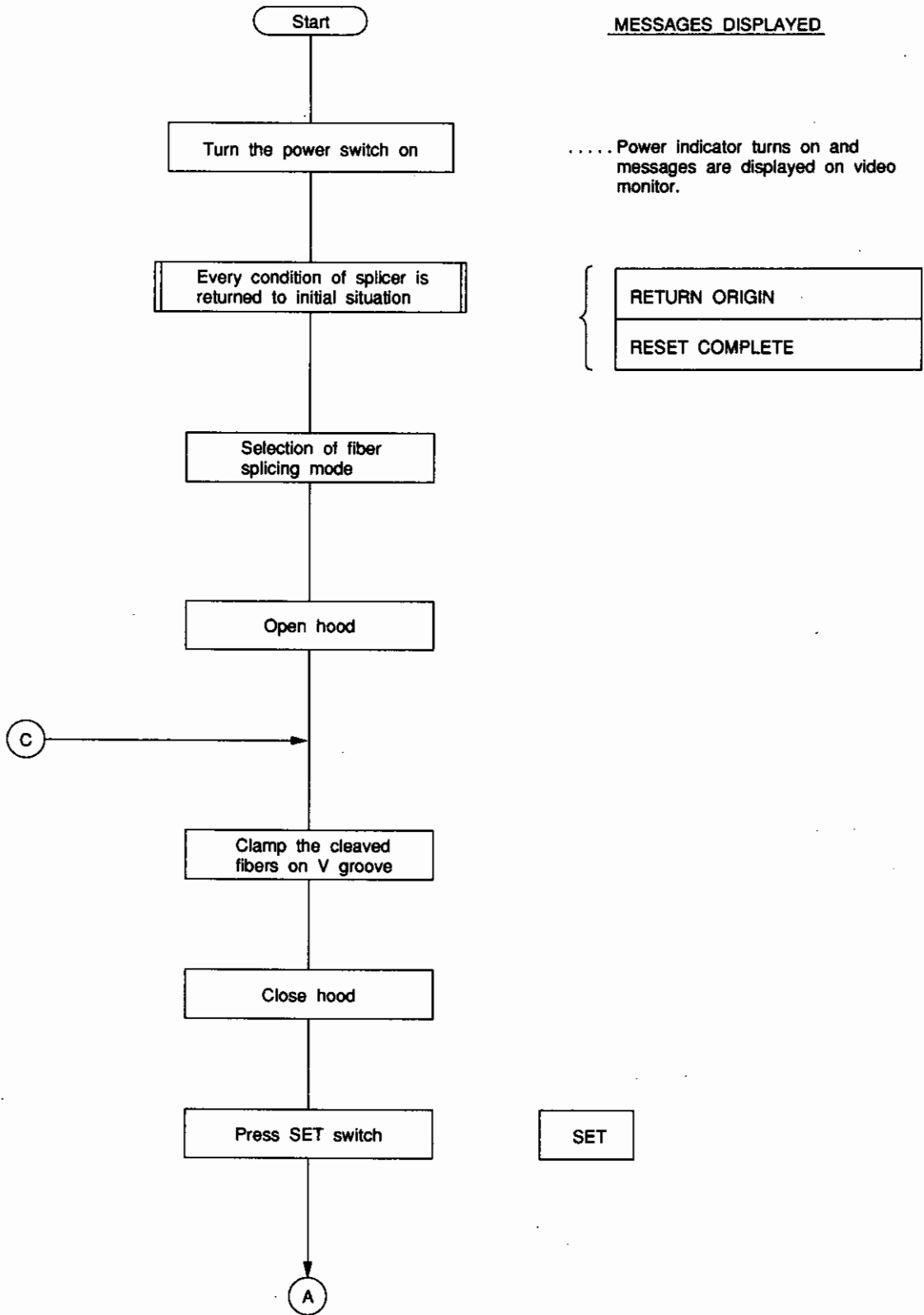

Fig. 4-3-B

Table 4-3: Automatic Splicing Operation for Fiber
(When the splicing operation has been completed normally)

Message	TYPE-35SE Operation	Field
GAP ADJUST	Adjusts the gap between the ends of the fibers.	Y
FOCUS ADJUST	Adjusts the focus for spliced fiber	
SPATTERING	Arc spattering (This process removes the dusts from the ends of the fibers by a short discharge.)	
FIBER END CHECK	Checks the cleaved angles and dust on the surfaces of the fibers.	
Y → X	Changes the field.	Y → X
FOCUS ADJUST	Adjusts the focus.	X
FIBER END CHECK	Checks the cleaved angle and dusts on the surfaces of the fibers.	
CORE ALIGN	Aligns the cores of the fiber in X direction.	
X → Y	Changes the field.	X → Y
FOCUS ADJUST	Adjusts the focus.	Y
CORE ALIGN	Aligns the cores of the fiber in Y direction.	
ARC FUSION	Splices the fibers by arc fusion.	
INSPECTION (HDCM)	Inspects the splice for estimation of splice loss and checking of the appearance.	
FIELD CHANGE Y → X	Changes the field.	Y → X
INSPECT	Inspects the splice for estimation of splice loss and checking of the appearance.	X
ES LOSS	Indicates inspection result	

4-4. Flow Chart of Operation



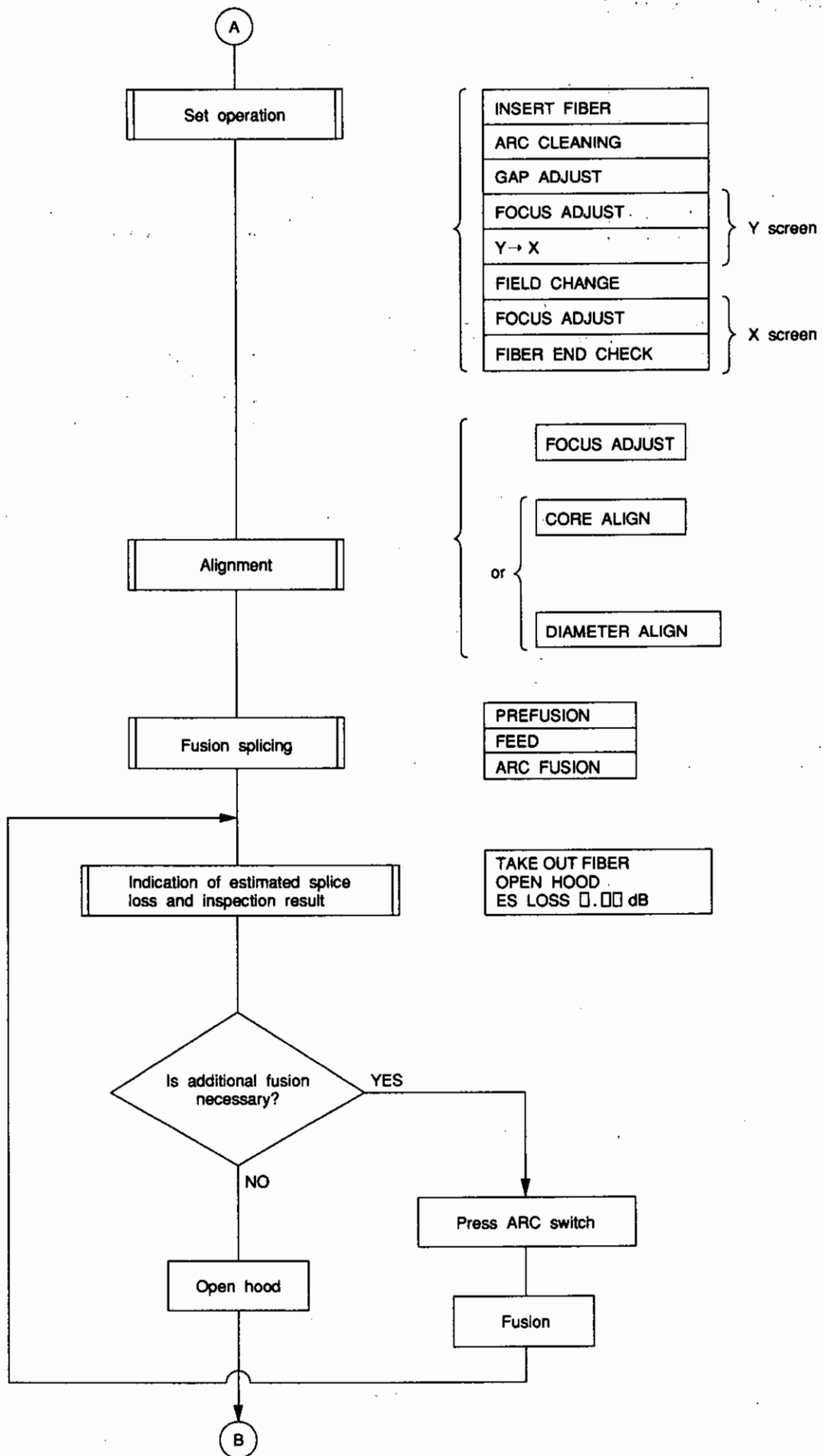

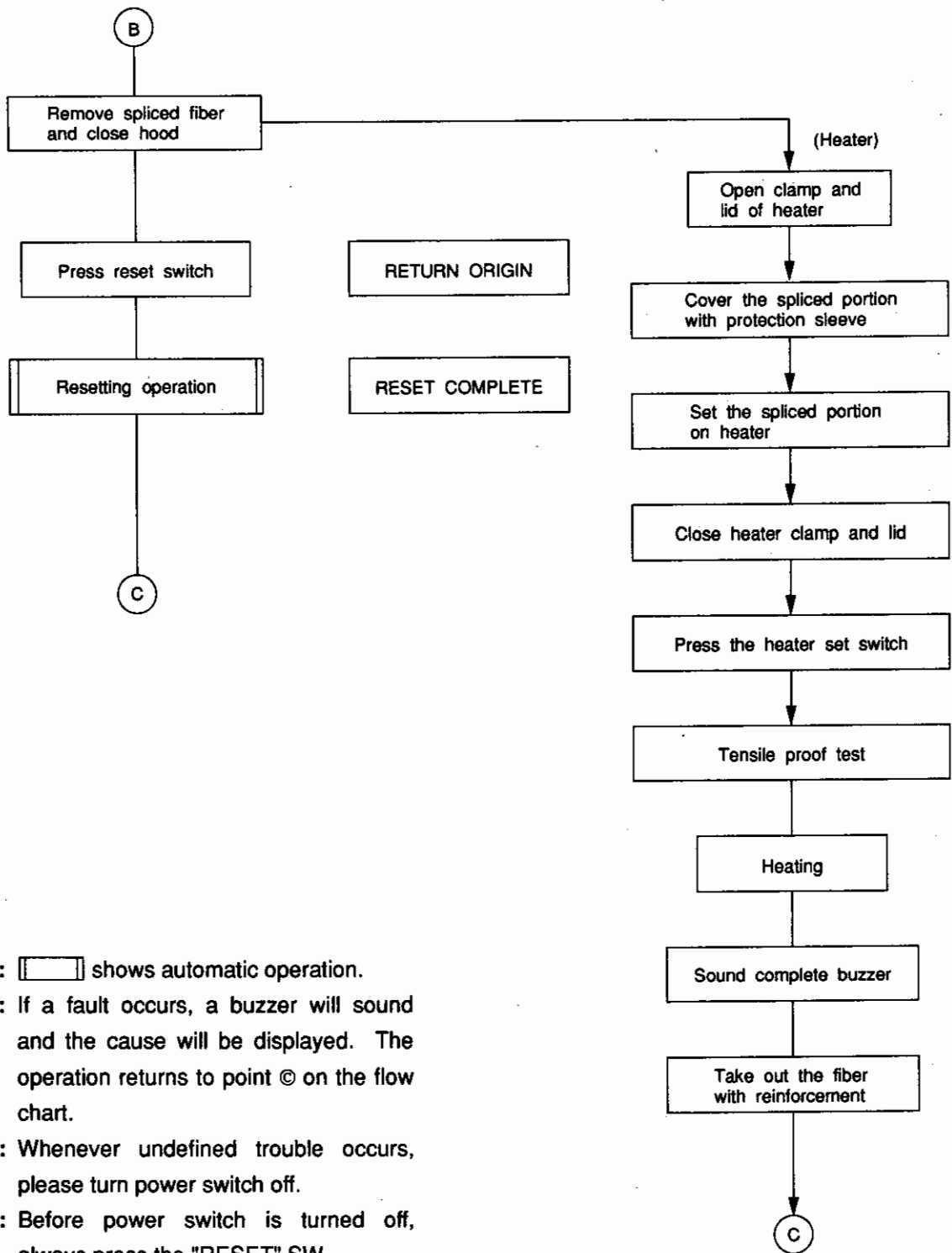

Note 1: [] shows automatic operation.

Note 2: If a fault occurs, a buzzer will sound and the cause will be displayed. The operation returns to point © on the flow chart.

Note 3: Whenever undefined trouble occurs, please turn power switch off.



Note 4: Before power switch is turned off, always press the "RESET" SW.

4-5 Evaluation of the Splice

The evaluation of the splice should be done by the estimated splice loss and the external appearance at the splice point.

- 1) The following splices should be rejected, even if the estimated splice loss is sufficiently low.

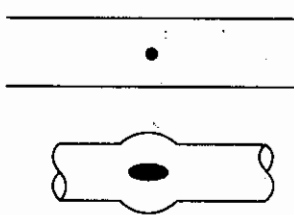
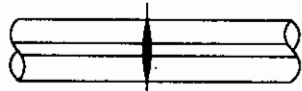
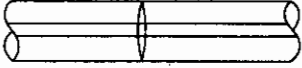
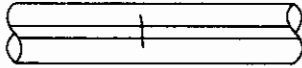
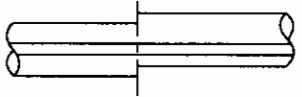

Table 4-5-A

<p>Bubble</p> 	<p>Be sure to remove this type of splice, because the splice loss can be extremely high.</p> <p>Caused by :</p> <ol style="list-style-type: none"> 1. Dust on fiber end 2. Condensing 3. Bad cleaving 4. Prefusion time is too short. 5. Arc power is too strong.
<p>Thick black line</p> 	<p>In this case, make refusion by ARC switch, and check it again. (*)</p>
<p>Black shadow</p> 	

- (*) In the case where fluorine doped fiber is spliced, a black line will always appear at the splicing point, but does not cause any damage to the characteristics of the optical transmission.

2) The following splices are acceptable, even if the external appearance at the splice point does not look good.

Table 4-5-B: Acceptable Splices

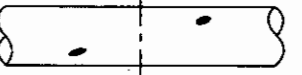
<p>White line</p> 	<p>It is all right if the estimated splice loss is within the specified value. This is due to optical causes upon observation, and there is no effect on the splice characteristics.</p>
<p>Blurred thin line</p> 	<p>Same as above</p>
	<p>Because of core alignment, this is possible for fiber with large core eccentricity.</p>
	<p>This appearance is due to differences in fiber diameter.</p>
<p>Dust or scratches</p> 	<p>No bad effect to spliced fiber but more care is necessary in cleaning and cleaving fibers.</p>

When the spliced portion is required to be observed in detail, "FIELD CHANGE" and "FOCUS UP" and "FOCUS DOWN" SW on Top mounted console panel are useful.

4-6 Reinforcement :

- (1) Open the heater cover, the left fiber clamp and right fiber clamp.

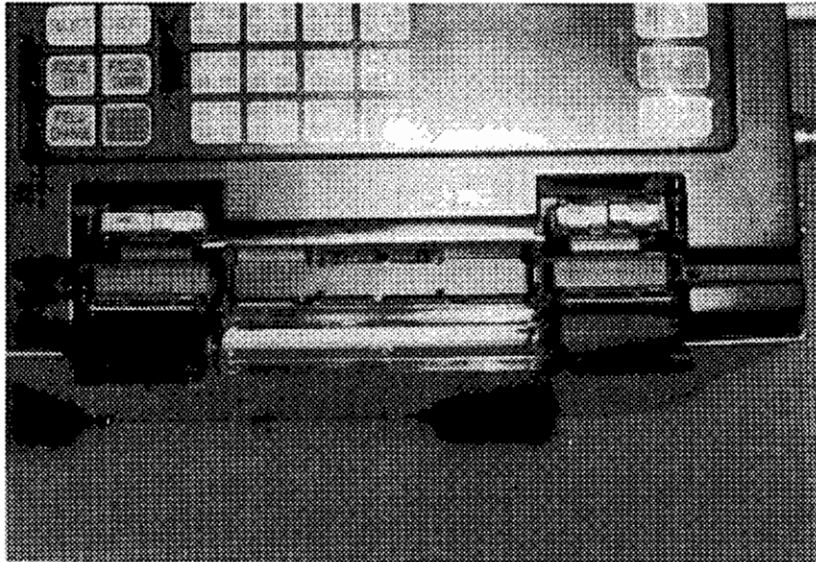

Fig. 4-6-A

- (2) Open the hood, take out the spliced portion, close the hood, and press the "RESET" SW.

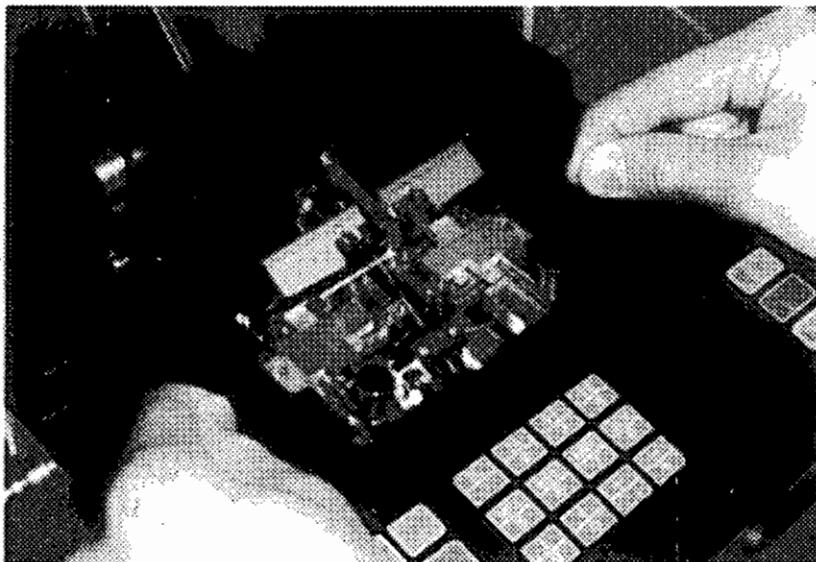

Fig. 4-6-B

(3) Slide Fiber Protection Sleeve FPS-1 over the Spliced Portion

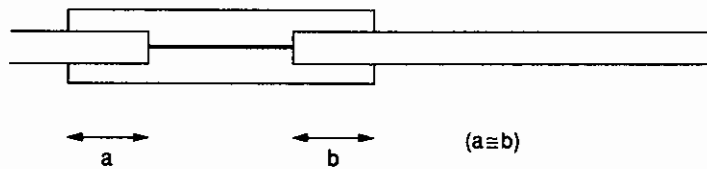
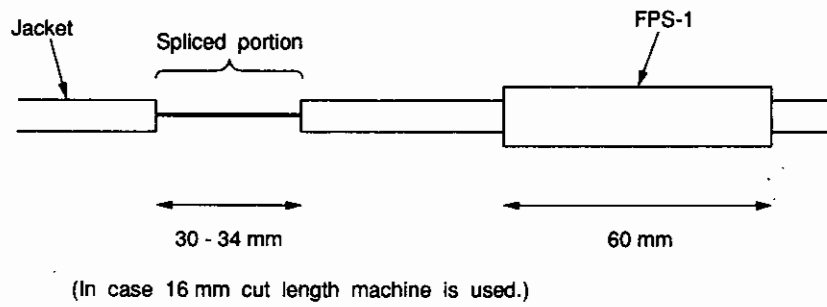

Fig. 4-6-C

- Note:**
- Make sure fiber coating is clean.
 - Put the sleeve over the splice as shown in Fig. 4-6-C.
 - Don't twist the fibers.
 - FPS-1 should be straight.

- (4) Apply a slight tension and place the splice in the heater, close the right-hand heater clamp by pressing down with the right-hand fiber.
- (5) Next, close the left-hand heater clamp while pulling the fiber slightly, and close the heater cover.

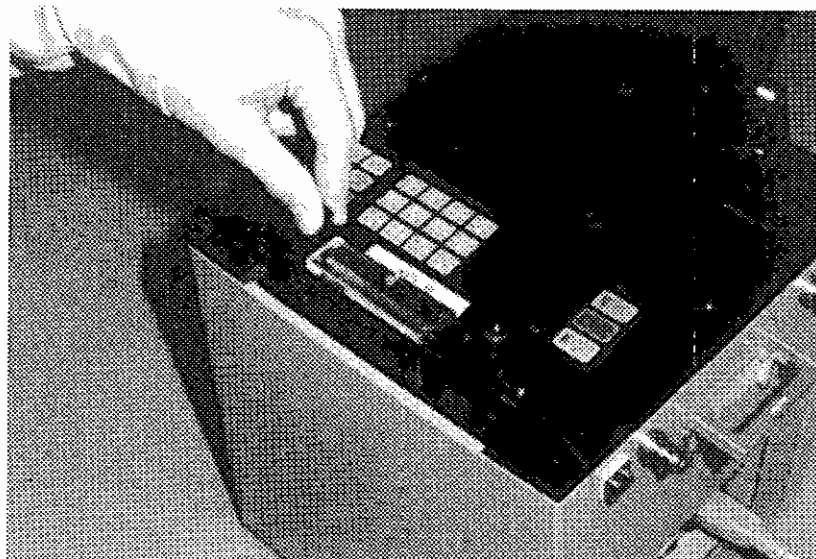

Fig. 4-6-D

- Note:**
- Fiber should be straight.
 - Make sure that there is no dust, or jelly in the protection sleeve

(6) Press the "HEATER SET" SW, and the "working" indicator lights up.

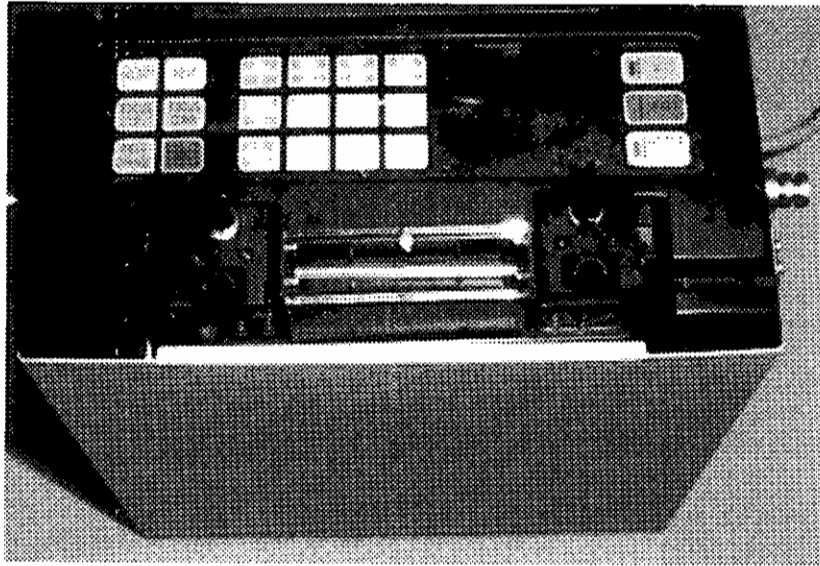

Fig. 4-6-E

- (7) After the tensile proof test(a few seconds), it takes a few minutes until the fiber protection sleeve is shrunk. A buzzer will indicate the finish of shrinking the sleeve.
If the fiber breaks, or the fiber is loosely clamped or slips during the tensile proof test, the buzzer will beep intermittently. Correct the condition before proceeding.

Note 1: Both the splicer and heater can be operated simultaneously.

Note 2: The tensile proof strength can be set from 50 to 500 grams. This value is set to 200 grams normally. If this value is required to change, please refer to Appendix A-3-9-2.

- (8) Open the heater cover and clamps.
Take out the protected splice carefully while pulling the fiber slightly.
Cool the protection sleeve for a few minutes, as it is very hot just after reinforcement.
- (9) Check the appearance of the reinforced portion.

Bad Protection Examples

- (a) Short coverage of coated fiber

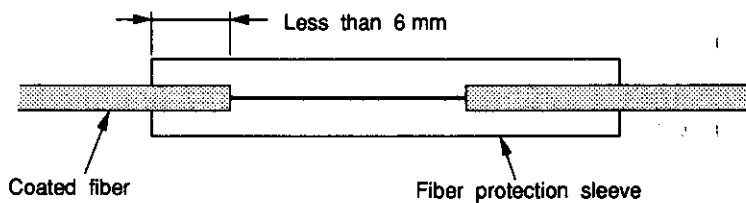

- (b) Bubble on bare fiber

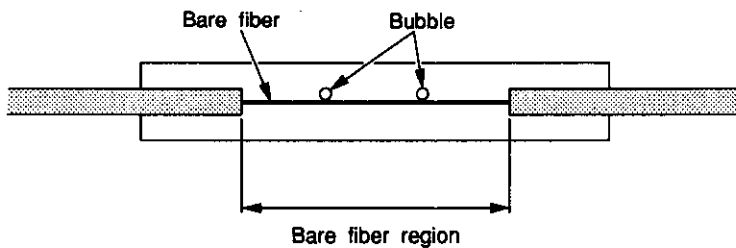

- (c) Bending bare fiber

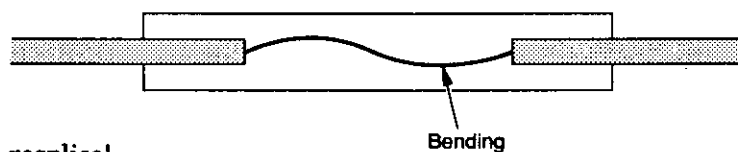

Please break and resplice!

Fig. 4-6-G

Good Protection Examples

(a) Unshrink sleeve end

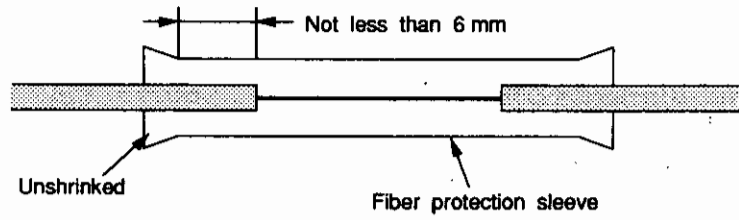

(b) Bubbles on coated fiber

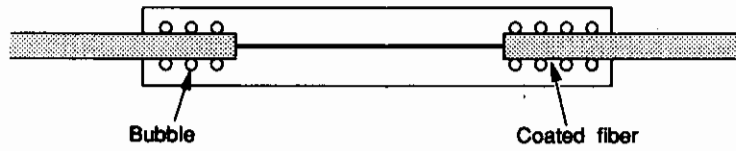

Fig. 4-6-H

4-7 End Operation

- (1) Press "RESET" SW, and turn off the power SW.
- (2) Put the attached cushion on the fiber clamp and the mirror for protecting from any shock.

5. Storage and Transportation

Always store and transport the splicer in the carrying case. Do not store at extreme temperatures or in humid conditions. Avoid impacts or shocks during handling.

Storage condition: Refer to section 1-3.

6. Counter Action to Faulty Motion

When the following fault occurs and the splicing process stops automatically, press "RESET SW" at first, then follow the counter actions mentioned below.

Table 6-1-A

Fault	Counter action and description
<p>ZLF LIMIT ZRF</p> <p>Forward direction system is limit position.</p>	<p>Meaning: Cannot find ends at initial fiber insertion.</p> <p>1) Re-Position and Re-clamp the faulty fiber. (Cause)</p> <ul style="list-style-type: none"> • The coating end is not in correct position. • The bare fiber is not on the bottom of V-groove. <p>2) Re-push the fiber clamp lever completely.</p> <p>3) Check the cleave length is correct.</p>
<p>CUT FAULT, DUST</p>	<p>Angle exceeds parameter limit value.</p> <p>1) Re-cleave the faulty fiber. (Left or Right)</p> <p>Cannot locate core, or is obscured.</p> <p>2) Check and mirror clean or replace it. (Refer to Appendix A-6) Make sure fiber type is SM.</p>
<p>MSXF LIMIT MSYF</p>	<p>Microscope exceeds travel limit while focussing.</p> <p>1) Turn the power SW OFF → ON</p> <p>2) Re-clamp fiber.</p>
<p>VXF LIMIT VYF</p>	<p>V-groove exceeds travel limit while positioning.</p> <p>1) Clean the bottom of V-groove, and fiber clamp. (Please refer to Appendix A-6)</p> <p>2) Turn the power SW OFF → ON</p> <p>3) Re-cleave, and re-clamp fiber.</p>
<p>DARK</p>	<p>Camera not receiving proper light.</p> <p>1) Check the cleave-length.</p> <p>2) Re-clamp the fiber.</p> <p>Clean illuminator, lens, mirror. In this case, fiber blocks the illumination and makes screen dark.</p>
<p>TIME OUT</p>	<p>1) Power switch OFF → ON</p> <p>2) Check fluctuation of power source voltage.</p>

(CONT.D)

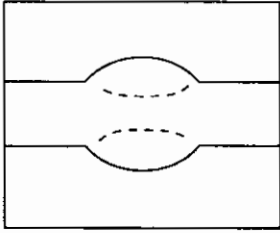
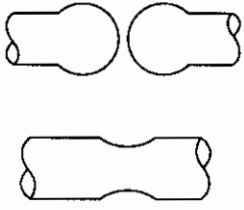
Fault	Counter action and description
<p>EXTERIOR FAULT</p>  <p>Diameter is faulty.</p>	<ol style="list-style-type: none"> 1) Re-cleave, and re-clamp fiber. 2) Change the parameter of overlap length <p>Arc too hot or cold — use arc test.</p>
<p>Splicer's movement stops without error message.</p>	<p>Turn the power SW OFF → ON.</p>
<p>EXTERIOR FAULT</p>  <ol style="list-style-type: none"> (1) The fiber ends are spherical. (2) Spliced portion is thin. 	<ol style="list-style-type: none"> 1) Re-cleave, and re-clamp fiber. 2) Make larger the OVERLAP length. (Cause) Lack of Z axis fiber feeding length. 3) Shorten the value of PREFUSION. 4) Shorten the value of Fusion

Appendix

A-1 Principle of DCM (Direct Core Monitoring)

- (1) When the fiber is illuminated by collimated light from the side, then the boundaries between core and cladding and between the cladding and air can be observed as black lines due to light refraction occurring.

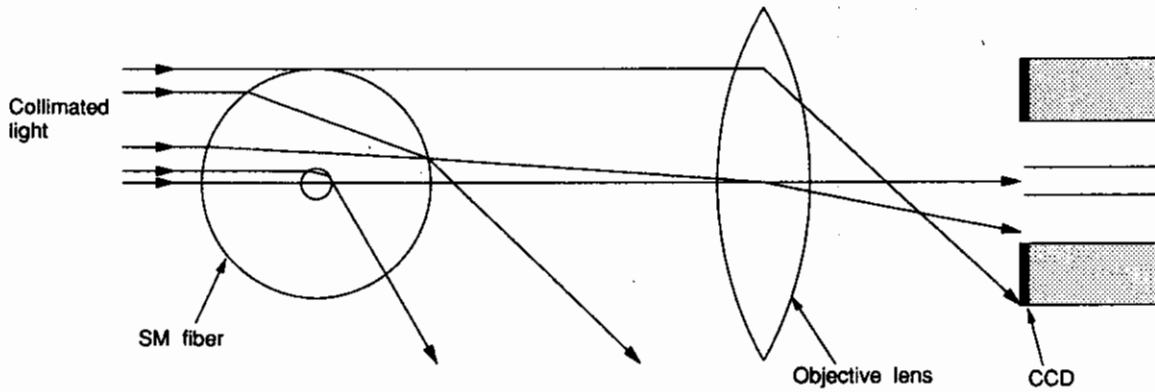

Fig. A-1-1

- (2) The side image of fiber is focused by the objective lens on to the CCD (Charge Coupled Device). The CCD camera produces analog video signals (NTSC format) which are converted to digital signals by the electrical circuit mounted in CCD camera.

The boundaries between core/cladding and cladding/air can be recognized by the micro computer built in the main body which processes the digital signals.

(3) Vertical and horizontal fiber views are observed by moving the microscope in the following optical system.

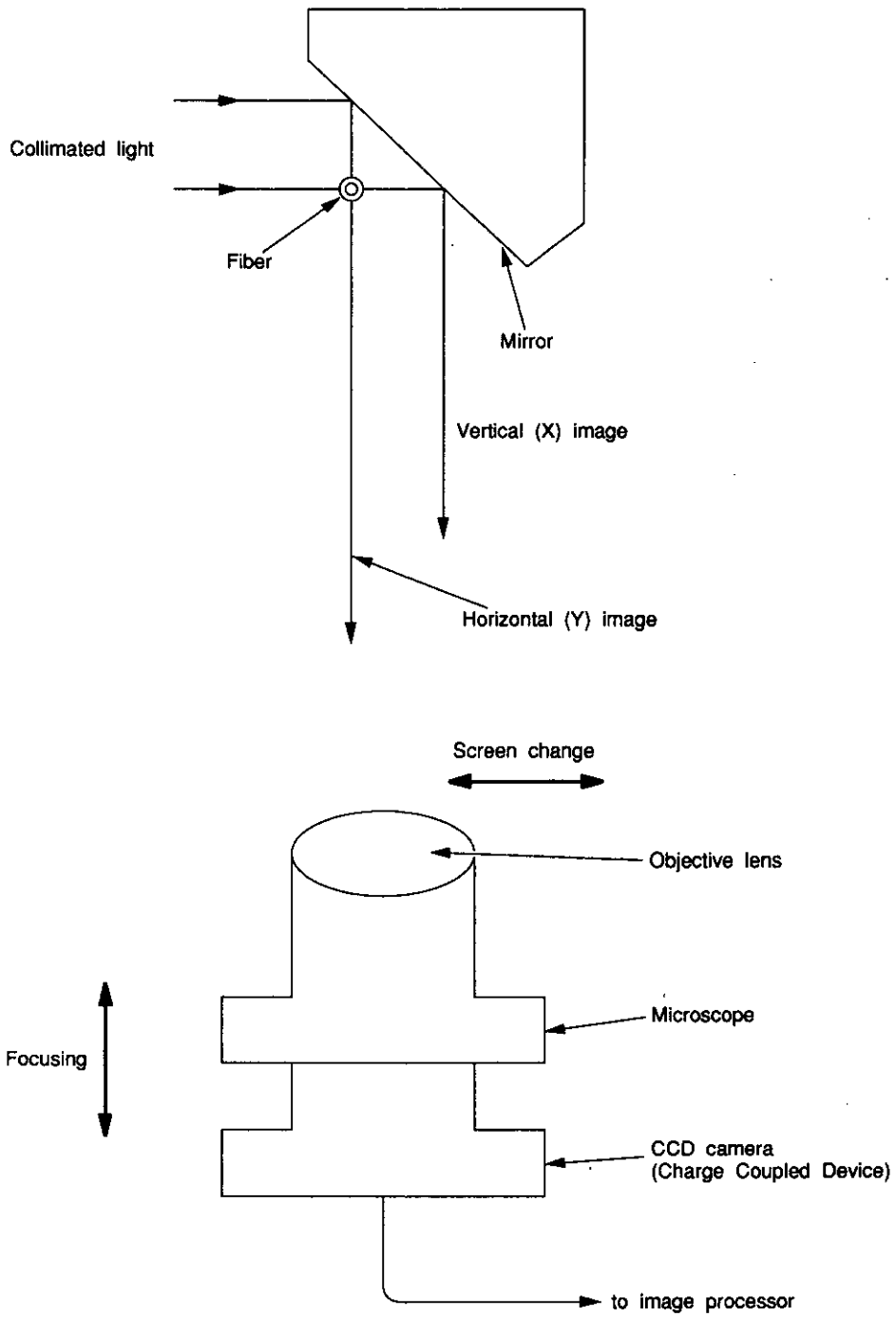

Fig. A-1-2

- (4) In case of SM fiber splicing the fiber core alignment can be achieved by moving the both sides of the V grooves as follows:

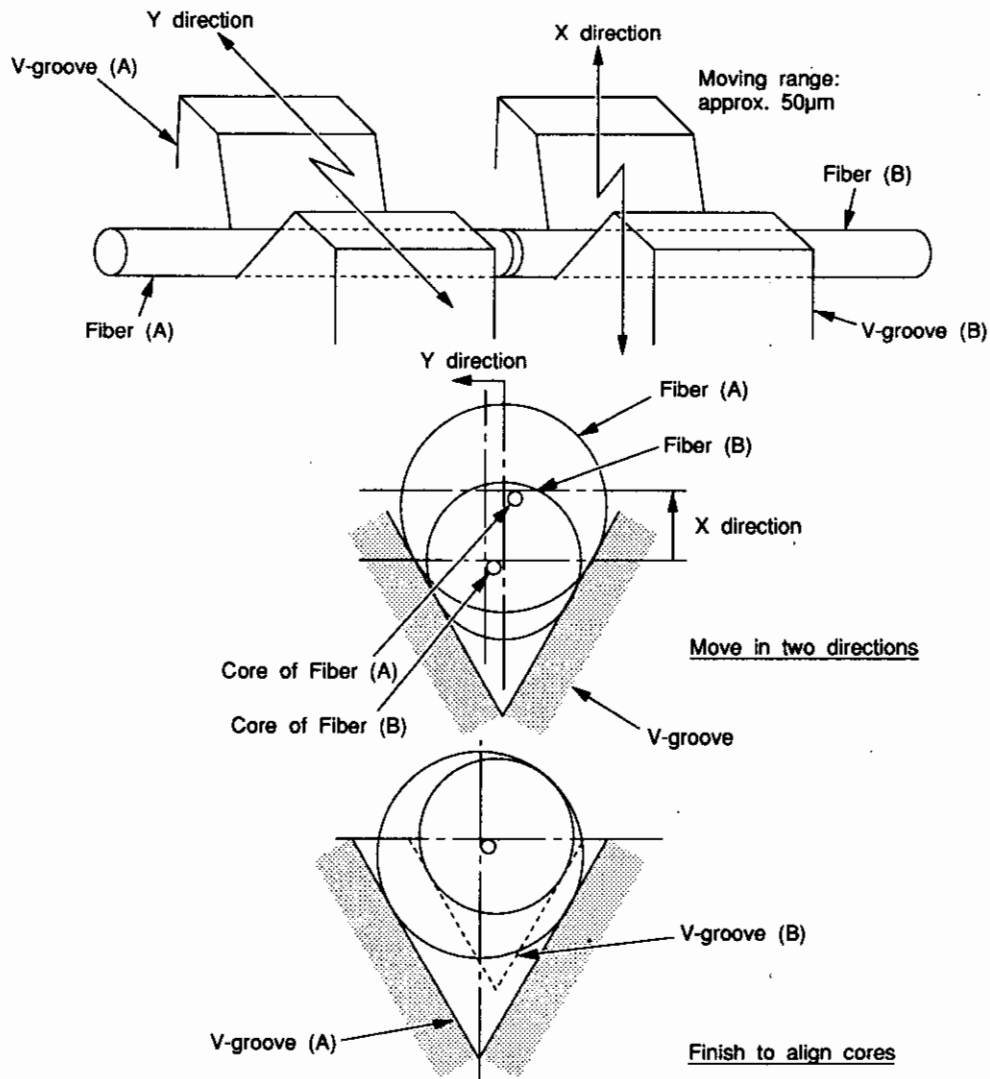

Fig. A-1-3

A-2 Arc Fusion Condition Parameter

Arc fusion splicing condition is defined by five parameters, as shown in the table below.

Table A-2-1: Five Arc Fusion Parameters

Name	Description	Range	Unit	Typical value for standard SM fiber	Typical value for standard MM fiber
ARC POWER	Arc discharge power	1 to 16	step	9	6
OVER LAP	Distance to be stuffed during fusion splicing	0 to 30.00	μm	15.00	15.00
PREFUSION	The time before the fiber (right side) is fed after start of discharge.	0 to 01.00	sec	0.1 to 0.2	0.10
FUSION	The time during arc discharge	0 to 20.00	sec	1.1 to 1.8	4.0 to 5.0
ARC GAP	The gap between the fiber end, before discharging the arc	0 to 40.00	μm	10.0	10.0

The following figure shows the procedure of the fusion splicing operation.

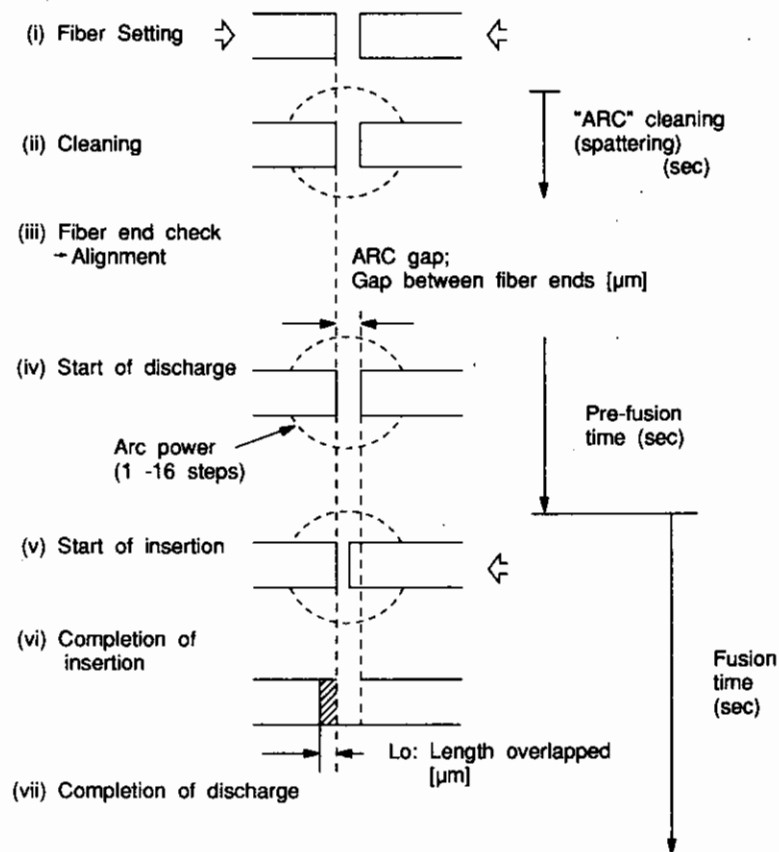

Fig. A-2-1

A-3 MODE FUNCTION AND USE METHOD

A-3-1 Mode Switching Method

1. Press console switches "*" and "RESET" at the same time on the condition setup screen to enter the mode switching screen (Figure A-3-1).
2. Press the console switch number to move the "*".
3. Press the SELECT switch on the console to enter each mode.
To enter automatic or manual mode, press the RESET switch after step 3.

MENU SELECT		
* 1	AUTOMATIC	MODE
2	MANUAL	MODE
3	STEP	MODE
4	COMMUNI,	MODE
5	PARAMETER	MODE
6	MAINTENANCE	MODE
7	FIBER NAME	MODE
8	HEATER COND.	MODE
SW:SEL/KEY+*/KEY		

Fig. A-3-1

A-3-2 Mode Function Explanation.

Table A-3-1

1. Automatic mode	This mode allows automatic splice to be performed and allows the user to setup splicing conditions.
2. Manual mode	This mode allows a user to perform each movement manually.
3. Step mode	This mode allows a user to perform splicing sequences intermittently.
4. Communication mode	This mode allows the user to perform remote operation of a splicer by transmitting commands from an external computer.
5. Parameter mode	This mode allows the user to read or write parameters that contain information such as the discharge conditions.
6. Maintenance mode	This mode allows the user to check the status of each motor built in a splicer, or check deterioration of each electrode.
7. Fiber name mode	This mode allows a user to define up to 21 alphanumeric fiber names.
8. Heater condition mode	This mode allows a user to make settings such as the type of protection sleeve or heating conditions.

A-3-3 Mode Help Screen

1. Press "*" and a number from "1" to "8" from the menu selection screen.
2. Press "*" and "1" to display the automatic mode help screen.

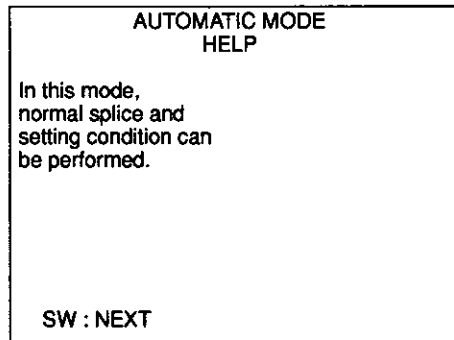

Fig. A-3-2

3. Press "*" and "2" to display the manual mode help screen.
4. Press the NEXT switch to return to the menu selection screen.
5. Press "*" and "3" to display the step mode help screen.

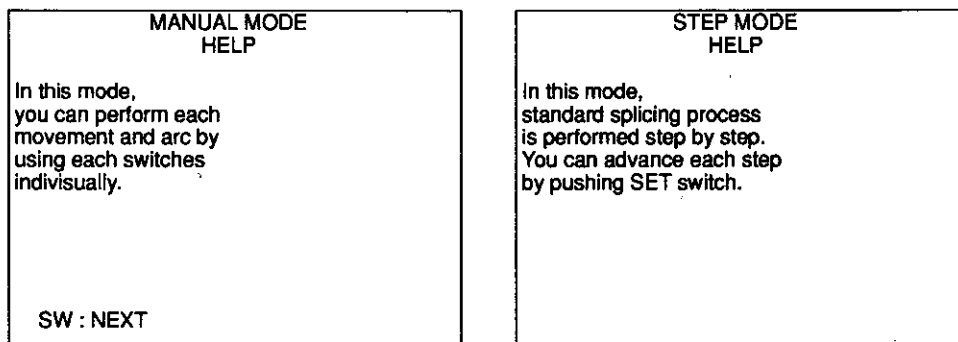

Fig. A-3-3

6. Press "*" and "4" to display the communication mode help screen.

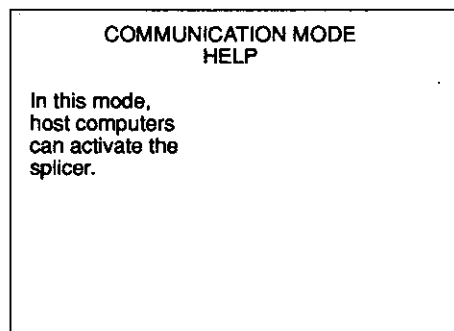

Fig. A-3-4

7. Press "*" and "5" to display the parameter mode help screen.

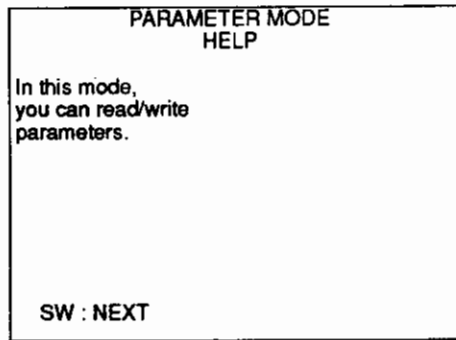

Fig. A-3-5

8. Press "*" and "6" to display the maintenance mode help screen.

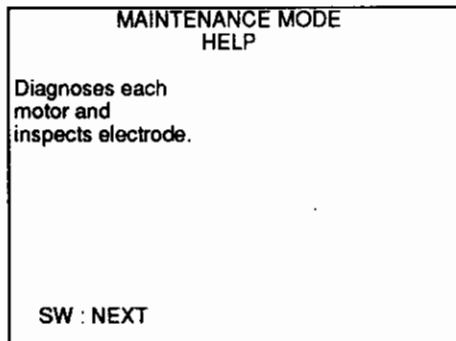

Fig. A-3-6

9. Press "*" and "7" to display the fiber name mode help screen.

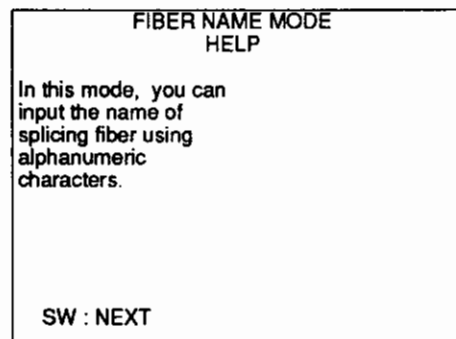

Fig. A-3-7

10. Press "*" and "8" to display the heater condition setup mode help screen.

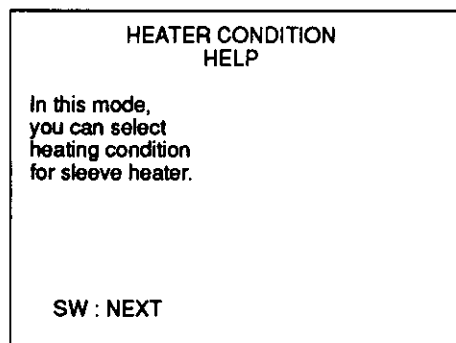

Fig. A-3-8

A-3-4 Automatic / Manual Mode Selection

A-3-4-1 Condition setup screen

1. Displays contents of splicing condition setup.
2. Displays the operation mode (automatic or manual).
3. Displays current date and time after power-on if they have already been set.
4. Press the SET switch to start operation in the specified operation mode.
5. Press a console switch from 1 to 6 to enter the desired setup screen.

```
SETTING CONDITION
(AUTOMATIC MODE)
1 PROFILE TYPE
  SM FIBER STD
2 ALIGN METHOD
  CORE
3 DIAMETER
  SIMILAR
4 DATA MEMORY
  AUTO STORE
5 ARC TEST (N O)
6 TIME

RESET COMPLETE
```

Fig. A-3-9

A-3-4-2 Fiber Type Selection Screen

1. Press switch 1 on the condition setup screen to display the screen shown below.
2. The current fiber is indicated by the "*".
3. Press 1, 2 or 3 to move the "*" to the fiber to be set.
4. Press the SELECT switch to enter the detail screen for the fiber specified by the "*".
5. The detail screen displays detailed information about the specified fiber.
6. Press the NEXT switch to return to the menu selection screen.

```
PROFILE TYPE

* 1 SM FIBER
  2 MM FIBER
  3 DSM FIBER

SW : SEL/NEXT/KEY
```

Fig. A-3-10

7. The current fiber is indicated by the "*".
8. Press a switch from 1 to 7 to display the "*" at the desired fiber.
9. Press the SELECT switch to set the fiber specified by the "*", and to enter the arc condition display screen.
10. Press the NEXT switch to return to the menu selection screen.

```
PROFILE TYPE DETAIL
* 1 SM FIBER STD
  2 OTHER1
  3 OTHER2
  4 OTHER3
  5 OTHER4
  6 OTHER5
  7 OTHER6

SW : SEL/NEXT/KEY
```

Fig. A-3-11

A-3-4-3 Arc Condition Display Screen

1. The arc condition display screen displays conditions corresponding to each fiber type.
2. Press a switch from 1 to 5 to display the "*" at the condition to update.
3. Press the NEXT switch to return to the menu selection screen.

```
ARC CONDITION
1 FUSION DURATION
  [001] 01. 50 (sec)
2 PREFUSION
  [002] 00. 10 (sec)
3 ARC GAP
  [003] 10. 00 (um)
4 OVERLAP
  [004] 15. 00 (um)
5 ARC POWER
  [005] 0009 (step)

SW : SEL/NEXT/KEY
```

Fig. A-3-12

A-3-4-4 Align Method Setup Screen

1. Press 2 on the condition setup screen to display the screen shown in following.
2. The current align method is indicated by the "*".
3. Press 1, 2, or 3 to display the "*" at the align method to be set.
4. Press the SELECT switch to set the align method specified by the "*".
5. Press the NEXT switch to return to the menu selection screen.

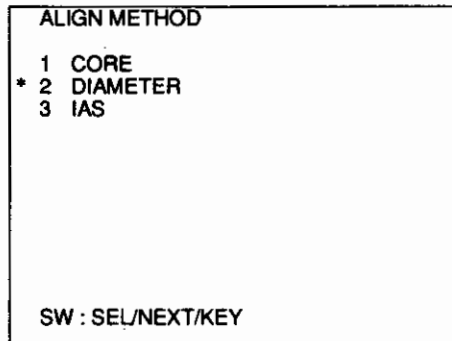

Fig. A-3-14

A-3-4-5 Diameter Condition Setup Screen

1. Press 3 on the condition setup screen to display the screen shown in following.
2. The current diameter condition is indicated by the "*".
3. Press 1 or 2 to display the "*" at the diameter to be set.
4. Press the SELECT switch to set the diameter specified by the "*".
5. Press the NEXT switch to return to the menu selection screen.

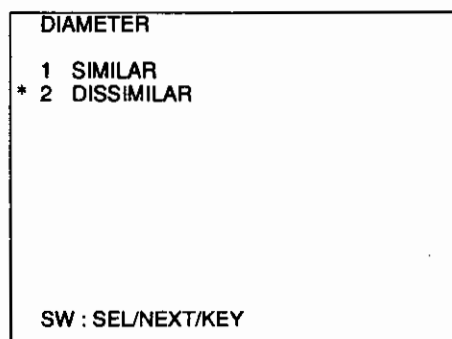

Fig. A-3-15

A-3-4-6 Data Display / Storage Setup Screen

1. Press 4 on the condition setup screen to display the screen shown in following.
2. The screen displays the setting choices for display and storage of result data.
3. Press the NEXT switch to return to the menu selection screen.

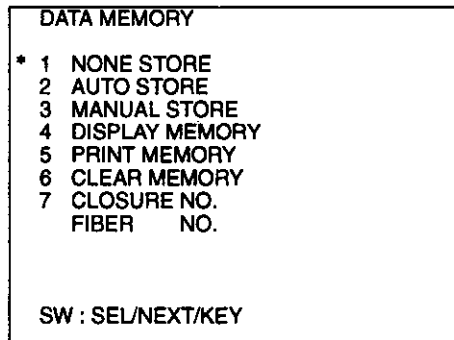

Fig. A-3-16

Table A-3-2

NONE STORE	Only the estimated loss is displayed and data is not stored.
AUTO STORE	Data is displayed on demand and stored.
MANUAL STORE	Data is displayed and stored on demand.
DISPLAY MEMORY	Data stored in memory is displayed on the screen. Press 4, then press the SELECT switch to execute.
PRINT MEMORY	Data stored in memory is an output to the printer. Press 5, then press the SELECT switch and select data number then press the SELECT switch to execute.
CLEAR MEMORY	Data stored in memory is deleted. Press 6, then press the SELECT switch to execute.
CLOSURE NO. FIBER NO.	Input the closure number and the fiber number to the data stored in memory. Press 7, and SELECT, then the Ten keys to execute.

* Note: Deleted data can't be restored.

A-3-4-7 Stored Data Display Screen

1. The screen displays the latest data (No. 1) that has been stored in memory.
2. Press a number switch while pressing the "*" switch to display the desired data of the number stored in memory.
3. To display previous data, press the "↑" arrow key to scroll the screen upward.
4. To display new data, press arrow key "↓" to scroll the screen downward.
5. Press the NEXT switch to return to the menu selection screen.

```
DATA 001
SM FIBER STD
CLOSURE NO. 001
FIBER NO. 001
LOSS =00.02 (dB)
CUT(L) =00.00 (deg)
CUT(R) =00.21 (deg)
OFFSET =00.00 (um)
OVERLAP =15.00 (um)
DEFORM =00.00 (deg)
POWER =0009 (step)
TENSION =0200 (g)
SW : NEXT/KEY+ */KEY
```

Fig. A-3-17

A-3-4-8 Arc Test Setup Screen

1. Press 5 on the condition setup screen to display the screen shown below.
2. The current arc test condition is indicated by the "*".
3. Press the SELECT switch to set the arc test condition specified by the "*".
4. Press 1 or 2 to display the "*" at the arc test condition to be set.
5. Press the NEXT switch to return to the menu selection screen.

```
ARC TEST
* 1 ARC TEST YES
  2 ARC TEST NO

SW : SEL/NEXT/KEY
```

Fig. A-3-18

A-3-4-9 Date Setup Screen

1. Press 6 on the condition setup screen to display the date/time setup screen.
2. Press switches 0 to 9 to set the year, month, date, hour, and minute in that order.
3. Press the SELECT switch to update the date and time at 1 to those at 2.
4. Press the " · " switch to erase the date and time entered at 2.
5. Press the NEXT switch to return to the menu selection screen.

```
TIME
1 PRESENT TIME
  91/11/04 14:02
2 SETTING TIME
  91/11/04 14:02

SW : SEL/NEXT/KEY/ ·
```

Fig. A-3-19

A-3-5 Communication Mode Selection

1. The system enters the communication command reception wait state.
2. The screen displays "communication mode".
3. To enter the communication mode from a screen other than the menu selection screen, press switches 1, "·", and RESET at the same time.
4. When the termination command "QUIT" is received, the screen returns to the mode selection screen.
5. To enter the communication mode from a screen other than the menu selection screen, press switches 1, "·", and RESET at the same time.

In this case, the screen does not return to the mode selection screen even if a termination command is received. Press the RESET switch to return to the condition setup screen when message "Reset switch ON" is displayed.

```
COMMUNICATION MODE
```

Fig. A-3-20

A-3-6 Parameter Mode Selection

A-3-6-1 Parameter Setup Screen

1. The read or write selection is displayed.
2. This screen is switched to the read / write screen only when a password is entered.
3. Press 1 or 2 to display the "*" at the desired position.
4. Hold "*" SW and press password "6130".
5. Press the SELECT switch to enter the read / write screen.
6. Press the NEXT switch to return to the menu selection screen.

```
PARAMETER MODE
* 1 READ PARAMETER
  2 WRITE PARAMETER

SW : SEL/NEXT/KEY
```

Fig. A-3-21

A-3-6-2 Read Parameter Screen

1. When this screen is displayed, parameter No. 001 is displayed.
2. Press the FIELD CHANGE switch to display the next No. parameter.
3. Press a parameter number from 0 to 9 while pressing "*" to display the parameter corresponding to the entered number.
4. Press the NEXT switch to return to the menu selection screen.

```
PARAMETER MODE
(READ PARAMETER)

NO 001
SM 1 FUSION DURATION
    01.50 (sec)

PARAMETER OK

SW : NEXT/FC/KEY+ *
```

Fig. A-3-22

A-3-6-3 Write Parameter Screen

1. When this screen is displayed, parameter No. 001 is displayed.
2. Press the FIELD CHANGE switch to display the next parameter.
3. Press a parameter number from 0 to 9 while pressing "*" to display the parameter corresponding to the entered number.
4. Press switches 0 to 9 to update the current parameter value.
5. Press the "·" arrow key to erase the entered value, and to display the current value.
6. Press the SELECT switch to set the current value with the entered value.
7. Press the NEXT switch to return to the menu selection screen.

```
PARAMETER MODE
(WRITE PARAMETER)

NO 001
SM 1 FUSION DURATION
      01.50 (sec)
      01.50

PARAMETER OK

SW : SEL/NEXT/FC/
      KEY+ */KEY/ ·
```

Fig. A-3-23

A-3-7 Maintenance Mode Selection

A-3-7-1 Maintenance Screen

1. This screen displays maintenance items.
2. Press 1 or 2 to display the "*" at the desired position.
3. Press the SELECT switch to enter the maintenance screen specified by the "*".
4. Press the NEXT switch to return to the menu selection screen.

```
MAINTENANCE MODE

* 1 MOTOR DRIVE
  2 ELECTRODE

SW : SEL/NEXT/KEY
```

Fig. A-3-24

A-3-7-2 Motor Drive Test Setup Screen

1. This screen displays test items.
2. Press a switch from 0 to 9 to display the "*" at the item to be tested.
3. Press the SELECT switch to enter the motor drive test screen.
4. Press the NEXT switch to return to the menu selection screen.

MAINTENANCE MODE		
(MOTOR DRIVE)		
* 1	ALL	MOTOR
2	ZL	MOTOR
3	ZR	MOTOR
4	MSX	MOTOR
5	MSY	MOTOR
6	VY	MOTOR
7	VX	MOTOR
8	MRR	MOTOR
9	HEAT	MOTOR
0	RUNNING TEST	
SW : SEL/NEXT/KEY		

Fig. A-3-25

A-3-7-3 Motor Drive Test Screen

1. This screen displays the item selected from the motor drive test setup screen.
2. When a switch from 1 to 9 is selected from the motor drive test setup screen, results of measurement, the direction, and the active motor are displayed.
3. Press the NEXT switch to return to the menu selection screen.

When 0 is selected, automatic running test is applied to all motors. The test is performed for the number of cycles set in open parameter (No. 136 Running test cycle).

MAINTENANCE MODE	
(ZL MOTOR)	
ZL	06.53 (sec)
REVERSE (ZL)	
SW : NEXT	

Fig. A-3-26

A-3-7-4 Electrode Inferiority Test Setup Screen

1. Select 2 from the maintenance screen, then press the SELECT switch.
2. Press a switch from 1 to 4 to display the "*" at the screen to enter.
3. Press the SELECT switch to enter into the screen.
4. Press the NEXT switch to return to the menu selection screen.

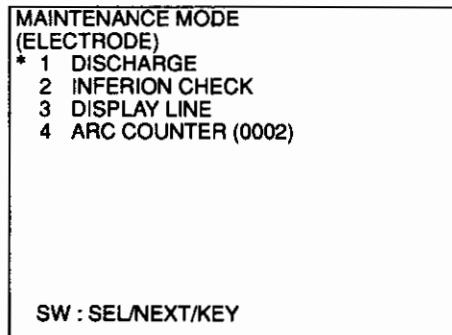

Fig. A-3-27

Table. A-3-3

1. Warm-up	Perform warm-up for the number of times specified in open parameter (No. 130) only when the hood is closed. Press the NEXT switch to stop the test.
2. Electrode abrasion test	Displays evaluation of the results of observation and measurement of the electrode tip shape.
3. Electrode and fiber line display	Display the electrode center line and fiber central position line.
4. Arc counter initialization	Reset the arc counter value to 0000 when the SELECT switch is pressed so that a new value can be written.

A-3-7-5 Warm-up Screen

1. Select 1 from the electrode inferiority test setup screen, then press the SELECT switch to enter this screen.
2. Warm-up (each cycle of which lasts 15 seconds) is implemented for the number of cycles set in the parameter.

(Open parameter
129 : Warm-up duration
130 : Number of warm-up cycles)

3. Press the NEXT switch to stop the warm-up, and to return to the menu selection screen.

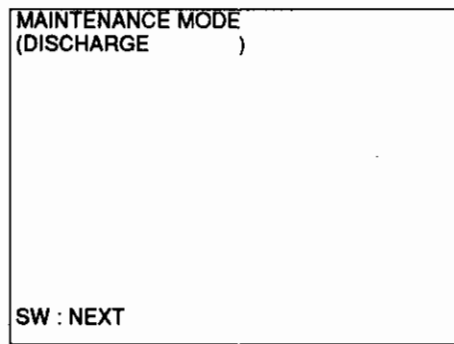

Fig. A-3-28

A-3-7-6 Electrode Abrasion Check Screen

1. Select 2 from the electrode inferiority check screen, then press the SELECT switch to enter this screen.
2. This screen displays the result of the electrode check.
3. Press the NEXT switch to return to the menu selection screen.

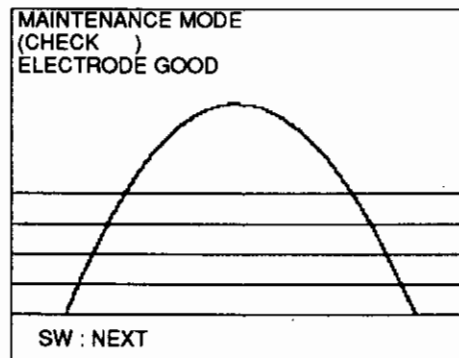

Fig. A-3-29

A-3-7-7 Electrode and Fiber Lines Display Screen

1. Select 3 from the electrode inferiority check setup screen, then press the SELECT switch to enter this screen.
2. Display the position by moving the center line each 2 dots: to the right by pressing the "→", and to the left by pressing the "←".
3. "ZL", "ZR", "MSX", "MSY", "MRR", "VX", and "VY".
4. "FOUCS UP" to switch the direction to forward direction, and "FOUCS DOWN" to switch the direction to move in reverse direction.
5. Press the NEXT switch to return to the menu selection screen.

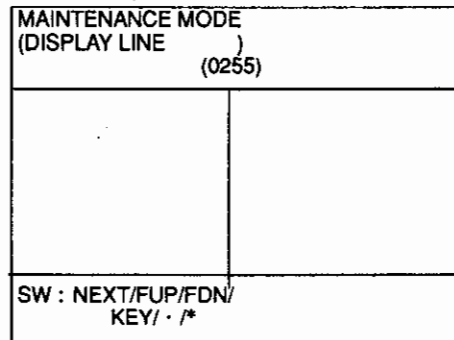

Fig. A-3-30

A-3-7-8 Arc Counter Initialization Screen

1. Select 4 from the electrode inferiority check setup screen, then press the SELECT switch to enter this screen.
2. Press the SELECT switch to display reset counter 0000.
3. Press the NEXT switch to return to the menu selection screen.

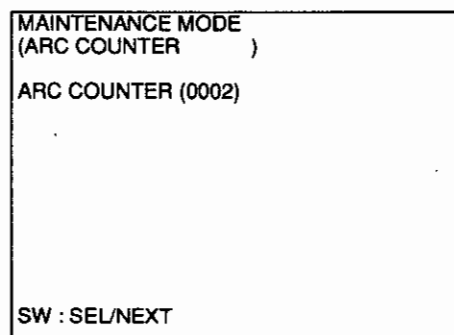

Fig. A-3-31

A-3-8 Fiber Name Mode Selection

1. Press 6 on the condition setup screen to enter this screen.
2. Press the FIELD CHANGE switch to move the "*".
When the "*" is at TYPE, move it to "No".
When the "*" is at "No", move it to "A".
When the "*" is at a character, move it to "TYPE".
Then, erase the name that has already been entered.
3. Press the SET switch to display within the parentheses () the character indicated by the "*". This is valid for characters only.
4. When the "*" is at "TYPE", press the (↑) arrow switch to display the fiber types in the order: SM → SPECIAL → MM → SM.
When the "*" is at "No", the numbers will be displayed in the order: 1 → 7 → 6 → ... → 1.
When the "*" is at "TYPE", press the () arrow switch to display the fiber types in the reverse order of the above.
When the "*" is at "No", the numbers will be displayed in the reverse order of the above.
5. When the "*" is at a character, press the "→" or "←" arrow switch to move it in the desired direction.
6. Press "CLR" to erase the entered numbers and characters.
7. Press the NEXT switch to return to the menu selection screen.

```
FIBER NAME MODE
(
* TYPE (SM
  No (1)
  ABCDEFGHIJKLMNOPQRST
  UVWXYZ0123456789-#

SW : SET/SEL/NEXT/FC/
KEY /→/←/↑/↓
```

Fig. A-3-32

A-3-9 Heater Setup Mode Selection

A-3-9-1 Heater Condition Setup Screen

1. Press 7 on the condition setup screen to enter this screen.
2. The "*" is displayed at the current condition.
3. Press the SELECT switch to enter into the heater condition display screen.
4. Press the NEXT switch to return to the menu selection screen.

HEATER COND MODE		
* 1	60mm	SLEEVE
2	40mm	SLEEVE
3	70mm	SLEEVE
4	OTHER	SLEEVE

SW : SEL/NEXT/KEY

Fig. A-3-33

A-3-9-2 Heater Condition Display Screen

1. This screen displays the heater condition corresponding to each sleeve.
2. Press a switch from 1 to 5 to display the "*" at the item to be edited.
3. Press the "*" to switch the display between °C and °F.
4. Press the NEXT switch to return to the menu selection screen.

HEATER COND MODE	
(60mm SLEEVE)	
1	HEAT DURATION [107] 0050 (sec)
2	HEAT TEMP [108] 0190 (°C)
3	FINISH TEMP [109] 0120 (°C)
4	PROOF TENSION [110] 0200 (g)
5	MAINTAINING [111] 0050 (g)

SW : SEL/NEXT/KEY/*

Fig. A-3-34

A-3-10 Manual Mode Operation Procedures

1. To change to the Condition Setting screens, press 2, then SELECT, and then RESET while in the Menu Selection screen.

SETTING CONDITION
(MANUAL MODE)
1 PROFILE TYPE
SM FIBER STD
2 ALIGN METHOD
CORE
3 DIAMETER
SIMILAR
4 DATA DISP/SAVE
AUTO/AUTO.
5 ARC TEST (N O)
6 TIME
RESET COMPLETE

Fig. A-3-35

2. For setup procedures, see page 45 (same as automatic mode).
3. Make sure the windshield is closed. Set a section of fiber and press the SET switch. The mirror descends, checks brightness, and halts temporarily.
After checking brightness, open the windshield to perform the following operations.
4. All drive systems can be operated manually.

Drive switches	Operation
ZL	Moves the left-hand mechanical chuck forward and reverse.
ZR	Moves the right-hand mechanical chuck forward and reverse.
VY	Moves the left-hand V-groove forward and reverse.
VX	Moves the right-hand V-groove forward and reverse.
MSX	Moves the microscope up and down.
MSY	Moves the microscope forward and reverse.
MRR	Moves the mirror up and down.
←, →	Change forward/reverse or up/down position.
ARC	Drains static charge.
RESET	Returns operation to the Condition Setting screen.
SELECT, NEXT	Used to set discharge conditions, etc.
HETER SET	Same operation as automatic mode.
FOCUS UP, FOCUS DOWN FIELD CHANGE	Not used.

5. To return to the automatic mode, press 1 and then SELECT, and then RESET while in the Menu Selection screen.

A-3-11 Step Mode Operation Procedures

1. To change to the Condition Setting screen, press 3, then SELECT, and then RESET while in the Menu Selection screen.

```
SETTING CONDITION
(STEP MODE)
1 PROFILE TYPE
  SM FIBER STD
2 ALIGN METHOD
  CORE
3 DIAMETER
  SIMILAR
4 DATA DISP/SAVE
  AUTO/AUTO.
5 ARC TEST (N O)
6 TIME

RESET COMPLETE
```

Fig. A-3-36

2. For setup procedures, see page 45 (same as automatic mode).
3. Set a section of fiber and press the SET switch.
The mirror checks brightness and then halts temporarily. Press the SET switch and go to the next step. The mirror halts temporarily after each step. Press the SET switch each time to proceed.
4. All drive systems can be operated manually. For operation details, see the manual mode operation procedures.
5. To return to automatic mode, press 1, then SELECT, and then RESET while in the Menu Selection screen.

A-4 Parameter List

No.	Name	Setting Range		Unit	Set value
		Upper limit	Lower limit		
1	SM 1 FUSION DURATION	20.00	00.00	sec	01.50
2	SM 1 PREFUSION	01.00	00.00	sec	00.10
3	SM 1 ARC GAP	40.00	00.00	um	10.00
4	SM 1 OVERLAP	80.00	00.00	um	15.00
5	SM 1 ARC POWER	0016	0001	step	0009
6	SM 2 FUSION DURATION	20.00	00.00	sec	01.50
7	SM 2 PREFUSION	01.00	00.00	sec	00.10
8	SM 2 ARC GAP	40.00	00.00	um	10.00
9	SM 2 OVERLAP	80.00	00.00	um	15.00
10	SM 2 ARC POWER	0016	0001	step	0009
11	SM 3 FUSION DURATION	20.00	00.00	sec	01.50
12	SM 3 PREFUSION	01.00	00.00	sec	00.10
13	SM 3 ARC GAP	40.00	00.00	um	10.00
14	SM 3 OVERLAP	80.00	00.00	um	15.00
15	SM 3 ARC POWER	0016	0001	step	0009
16	SM 4 FUSION DURATION	20.00	00.00	sec	01.50
17	SM 4 PREFUSION	01.00	00.00	sec	00.10
18	SM 4 ARC GAP	40.00	00.00	um	10.00
19	SM 4 OVERLAP	80.00	00.00	um	15.00
20	SM 4 ARC POWER	0016	0001	step	0009
21	SM 5 FUSION DURATION	20.00	00.00	sec	01.50
22	SM 5 PREFUSION	01.00	00.00	sec	00.10
23	SM 5 ARC GAP	40.00	00.00	um	10.00

No.	Name	Setting Range		Unit	Set value
		Upper limit	Lower limit		
24	SM 5 OVERLAP	80.00	00.00	um	15.00
25	SM 5 ARC POWER	0016	0001	step	0009
26	SM 6 FUSION DURATION	20.00	00.00	sec	01.50
27	SM 6 PREFUSION	01.00	00.00	sec	00.10
28	SM 6 ARC GAP	40.00	00.00	um	10.00
29	SM 6 OVERLAP	80.00	00.00	um	15.00
30	SM 6 ARC POWER	0016	0001	step	0009
31	SM 7 FUSION DURATION	20.00	00.00	sec	01.50
32	SM 7 PREFUSION	01.00	00.00	sec	00.10
33	SM 7 ARC GAP	40.00	00.00	um	10.00
34	SM 7 OVERLAP	80.00	00.00	um	15.00
35	SM 7 ARC POWER	0016	0001	step	0009
36	MM 1 FUSION DURATION	20.00	00.00	sec	04.50
37	MM 1 PREFUSION	01.00	00.00	sec	00.15
38	MM 1 ARC GAP	40.00	00.00	um	10.00
39	MM 1 OVERLAP	80.00	00.00	um	15.00
40	MM 1 ARC POWER	0016	0001	step	0006
41	MM 2 FUSION DURATION	20.00	00.00	sec	04.50
42	MM 2 PREFUSION	01.00	00.00	sec	00.15
43	MM 2 ARC GAP	40.00	00.00	um	10.00
44	MM 2 OVERLAP	80.00	00.00	um	15.00
45	MM 2 ARC POWER	0016	0001	step	0006
46	MM 3 FUSION DURATION	20.00	00.00	sec	04.50
47	MM 3 PREFUSION	01.00	00.00	sec	00.15

No.	Name	Setting Range		Unit	Set value
		Upper limit	Lower limit		
48	MM 3 ARC GAP	40.00	00.00	um	10.00
49	MM 3 OVERLAP	80.00	00.00	um	15.00
50	MM 3 ARC POWER	0016	0001	step	0006
51	MM 4 FUSION DURATION	20.00	00.00	sec	04.50
52	MM 4 PREFUSION	01.00	00.00	sec	00.15
53	MM 4 ARC GAP	40.00	00.00	um	10.00
54	MM 4 OVERLAP	80.00	00.00	um	15.00
55	MM 4 ARC POWER	0016	0001	step	0006
56	MM 5 FUSION DURATION	20.00	00.00	sec	04.50
57	MM 5 PREFUSION	01.00	00.00	sec	00.15
58	MM 5 ARC GAP	40.00	00.00	um	10.00
59	MM 5 OVERLAP	80.00	00.00	um	15.00
60	MM 5 ARC POWER	0016	0001	step	0006
61	MM 6 FUSION DURATION	20.00	00.00	sec	04.50
62	MM 6 PREFUSION	01.00	00.00	sec	00.15
63	MM 6 ARC GAP	40.00	00.00	um	10.00
64	MM 6 OVERLAP	80.00	00.00	um	15.00
65	MM 6 ARC POWER	0016	0001	step	0006
66	MM 7 FUSION DURATION	20.00	00.00	sec	04.50
67	MM 7 PREFUSION	01.00	00.00	sec	00.15
68	MM 7 ARC GAP	40.00	00.00	um	10.00
69	MM 7 OVERLAP	80.00	00.00	um	15.00
70	MM 7 ARC POWER	0016	0001	step	0006
71	DSM 1 FUSION DURATION	20.00	00.00	sec	01.50
72	DSM 1 PREFUSION	01.00	00.00	sec	00.10

No.	Name	Setting Range		Unit	Set value
		Upper limit	Lower limit		
73	DSM 1 ARC GAP	40.00	00.00	um	10.00
74	DSM 1 OVERLAP	80.00	00.00	um	15.00
75	DSM 1 ARC POWER	0016	0001	step	0009
76	DSM 2 FUSION DURATION	20.00	00.00	sec	01.50
77	DSM 2 PREFUSION	01.00	00.00	sec	00.10
78	DSM 2 ARC GAP	40.00	00.00	um	10.00
79	DSM 2 OVERLAP	80.00	00.00	um	15.00
80	DSM 2 ARC POWER	0016	0001	step	0009
81	DSM 3 FUSION DURATION	20.00	00.00	sec	01.50
82	DSM 3 PREFUSION	01.00	00.00	sec	00.10
83	DSM 3 ARC GAP	40.00	00.00	um	10.00
84	DSM 3 OVERLAP	80.00	00.00	um	15.00
85	DSM 3 ARC POWER	0016	0001	step	0009
86	DSM 4 FUSION DURATION	20.00	00.00	sec	01.50
87	DSM 4 PREFUSION	01.00	00.00	sec	00.10
88	DSM 4 ARC GAP	40.00	00.00	um	10.00
89	DSM 4 OVERLAP	80.00	00.00	um	15.00
90	DSM 4 ARC POWER	0016	0001	step	0009
91	DSM 5 FUSION DURATION	20.00	00.00	sec	01.50
92	DSM 5 PREFUSION	01.00	00.00	sec	00.10
93	DSM 5 ARC GAP	40.00	00.00	um	10.00
94	DSM 5 OVERLAP	80.00	00.00	um	15.00
95	DSM 5 ARC POWER	0016	0001	step	0009
96	DSM 6 FUSION DURATION	20.00	00.00	sec	01.50
97	DSM 6 PREFUSION	01.00	00.00	sec	00.10

No.	Name	Setting Range		Unit	Set value
		Upper limit	Lower limit		
98	DSM 6 ARC GAP	40.00	00.00	um	10.00
99	DSM 6 OVERLAP	80.00	00.00	um	15.00
100	DSM 6 ARC POWER	0016	0001	step	0009
101	DSM 7 FUSION DURATION	20.00	00.00	sec	01.50
102	DSM 7 PREFUSION	01.00	00.00	sec	00.10
103	DSM 7 ARC GAP	40.00	00.00	um	10.00
104	DSM 7 OVERLAP	80.00	00.00	um	15.00
105	DSM 7 ARC POWER	0016	0001	step	0009
106	ARC CLEAN DURATION	01.00	00.00	sec	00.10
107	HEAT 1 HEAT DURATION	60.00	00.00	sec	15.00
108	HEAT 1 HEAT TEMP.	0250	0000	°C	0180
109	HEAT 1 FINISH TEMP.	0200	0000	°C	0150
110	HEAT 1 PROOF TENSION	0500	0000	g	0200
111	HEAT 1 MAINTAINING	0500	0000	g	0050
112	HEAT 2 HEAT DURATION	60.00	00.00	sec	05.00
113	HEAT 2 HEAT TEMP.	0250	0000	°C	0180
114	HEAT 2 FINISH TEMP.	0200	0000	°C	0150
115	HEAT 2 PROOF TENSION	0500	0000	g	0200
116	HEAT 2 MAINTAINING	0500	0000	g	0050
117	HEAT 3 HEAT DURATION	60.00	00.00	sec	20.00
118	HEAT 3 HEAT TEMP.	0250	0000	°C	0180
119	HEAT 3 FINISH TEMP.	0200	0000	°C	0150
120	HEAT 3 PROOF TENSION	0500	0000	g	0200
121	HEAT 3 MAINTAINING	0500	0000	g	0050

No.	Name	Setting Range		Unit	Set value
		Upper limit	Lower limit		
122	HEAT 4 HEAT DURATION	60.00	00.00	sec	10.00
123	HEAT 4 HEAT TEMP.	0250	0000	°C	0180
124	HEAT 4 FINISH TEMP.	0200	0000	°C	0150
125	HEAT 4 PROOF TENSION	0500	0000	g	0200
126	HEAT 4 MAINTAINING	0500	0000	g	0050
127	FIBER END ANGLE	20.00	00.00	deg	02.00
128	ARC COUNTER	9999	0000		0000
129	WARM-UP DURATION	0015	0000	sec	0001
130	WARM-UP NUMBER	0100	0000		0030
131	ELECTRODE LINE	0300	0000	dot	0255
132	JOB CONTROL SW	1777	0000		0022
133	FAN / BUZZER BIT	0003	0000		0003
134	SAMPLING LINE BIT	0001	0000		0001
135	BAUD RATE	0006	0001		0004
136	RUNNING TEST NUMBER	9999	0001		0030
137	WARM UP INTERVAL	0200	0001	sec	0015
138	HEATER NO.1 (60 mm) TENSION KEEP	03.00	00.00	sec	01.00
139	HEATER NO.2 (40 mm) TENSION KEEP	03.00	00.00	sec	01.00
140	HEATER NO.3 (70 mm) TENSION KEEP	03.00	00.00	sec	01.00
141	HEATER NO.4 (SPECIAL) TENSION KEEP	03.00	00.00	sec	01.00
142	HEATER NO.1 (60 mm) TIME OUT	0200	0000	sec	0120
143	HEATER NO.2 (40 mm) TIME OUT	0200	0000	sec	0120
144	HEATER NO.3 (70 mm) TIME OUT	0200	0000	sec	0120
145	HEATER NO.4 (SPECIAL) TIME OUT	0200	0000	sec	0120

Remark

No.	Mark	Designation	Details of Setting
132	JOBSW	Job control switch	<p style="text-align: center;">D15 D12 D11 D8 D7 D4 D3 D0</p> <p style="text-align: center;"> <input type="checkbox"/> <input type="checkbox"/> <input type="checkbox"/> *8 <input type="checkbox"/> <input type="checkbox"/> *7 <input type="checkbox"/> *6 <input type="checkbox"/> *5 <input type="checkbox"/> *4 <input type="checkbox"/> *3 <input type="checkbox"/> *2 <input type="checkbox"/> *1 </p> <p> *1. D0: Automatic resetting at an error that occurs before fusion (0=no (default), 1=yes) (0=no, 1=yes (default)) *2. D1: Display of operating message (0=no, 1=yes (default)) *3. D5: HDCM (0=no, 1=yes (default)) *4. D6: Rotally chuck, stop before align. (0=no (default), 1=yes) *5. D8: HP computer "LOSMS" command I/F (0=no (default), 1=yes) *6. D9: Rotally chuck, stop before Arc. (0=no (default), 1=yes) *7. D10: COERCION splice (0=no (default), 1=yes) *8. D12: Change the normal machine or the 4 mm machine. (0=Normal (default), 1=4 mm) </p>
133	FANBZ	Fan driving/buzzer sounding ON/OFF	<p style="text-align: center;">D15 D12 D11 D8 D7 D4 D3 D0</p> <p style="text-align: center;"> <input type="checkbox"/> <input type="checkbox"/> <input type="checkbox"/> <input type="checkbox"/> <input type="checkbox"/> <input type="checkbox"/> <input type="checkbox"/> <input type="checkbox"/> <input type="checkbox"/> <input type="checkbox"/> <input type="checkbox"/> <input type="checkbox"/> <input type="checkbox"/> <input type="checkbox"/> <input type="checkbox"/> *1 </p> <p> *1.D0:Fan driving (0=no, 1=yes (default)) *2.D1:Buzzer sounding (0=no, 1=yes (default)) </p>
134	SLDSP	Sampling line indication ON/OFF	0=no, 1=yes (default)
135	BPS	Transmission speed	1=300(bps), 2=600(bps), 3=1200(bps), 4=2400(bps)(default), 5=4800(bps), 6=3600(bps)

*IAS: (Intentional Axis shift) : A alignment method for large concentricity error fiber.

A-5 RS232C Interface

An RS232C port is located on the I/O panel on the right side of the main unit.

The user can use a CPU through this port to perform parameter setting, remote connection, or manual operation.

Interface

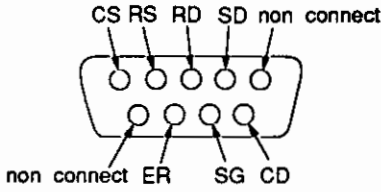
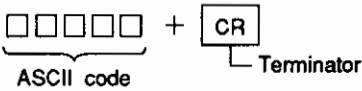
Item	Specifications
Connector	D-Sub 9 pins
Pin layout	
Start bit Stop bit Baud rate Data bit Parity Transmission system X on / off control	1 1 2400 7 even Full duplex, no protocol None
Data format	

For detailed specifications, refer to the operation manual for the HHC-35SE (hand-held computer).

A-6 Primary Maintenance

A-6-1 Cleaning the V-groove and bare fiber clamp

Keep the V-groove and bare fiber clamp clean to prevent fiber dislocation, which can be caused when dirt adheres to these parts. If dirt is adhered, open the hood, pull the clamp lever, and wipe the dirt away from these parts with a cotton swab soaked in 99.5 percent or purer alcohol. Then, rub these parts with a dry cotton swab.

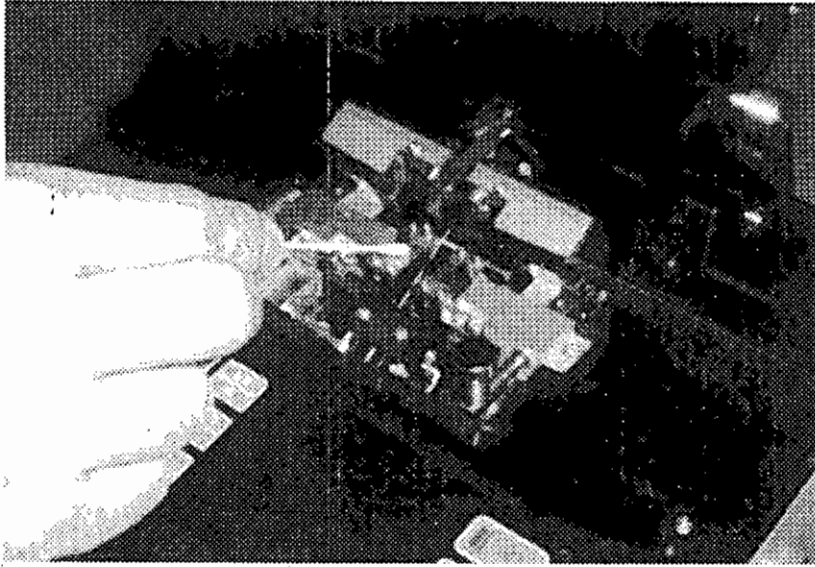

Wipe the V-groove strongly.

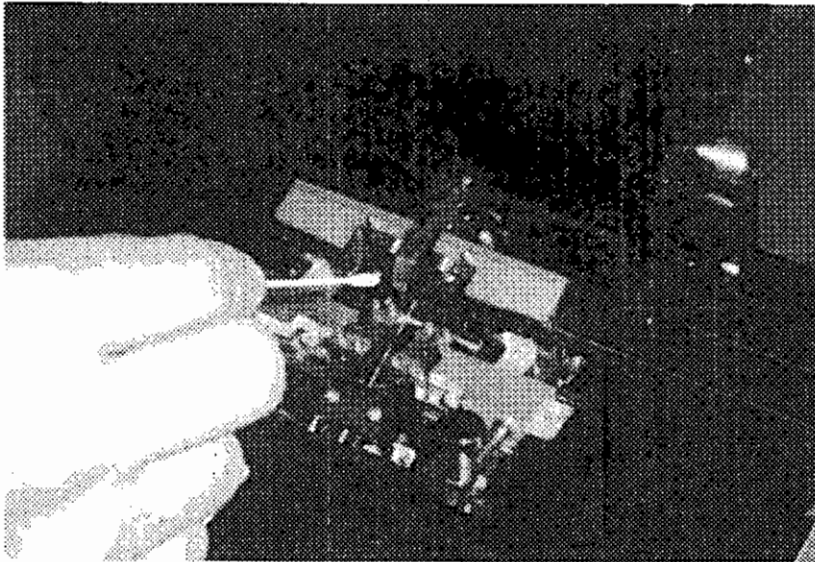
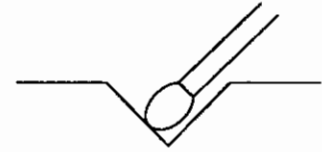

Wipe the bare fiber clamp strongly.

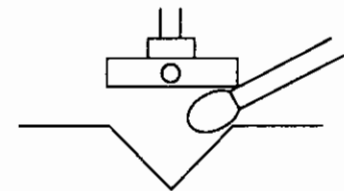

A-6-2 Cleaning the Mirror

Keep the surface of the mirror clean. If dirt is adhered to the surface, an error may occur during image processing.

Procedure:

- (1) Set the power switch to OFF.
- (2) Open the hood.
- (3) Clean the surface of the mirror with a cotton swab soaked in 99.5 percent or purer alcohol.
- (4) Use a dry swab to prevent spotting of the mirror.

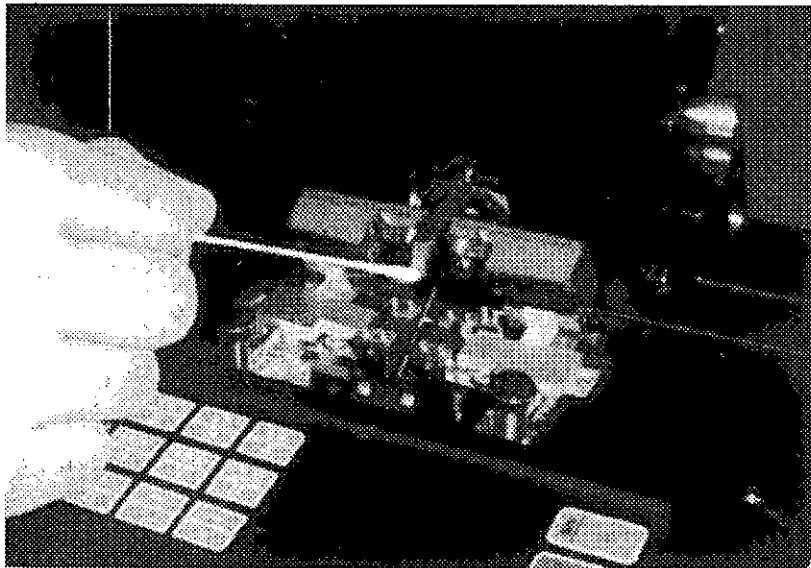

A-6-3 Cleaning the Objective Lens

Keep the surface of the objective lens clean. If dirt is adhered to the surface, an error may occur during image processing.

Procedure:

- (1) Set the power switch to OFF.
- (2) Open the hood.
- (3) Remove the forward electrode (refer to Appendix A6-5).
- (4) As shown in the figure below, use a cotton swab soaked in 99.5 percent or purer alcohol to clean the objective lens from the center to the perimeter. Dry with a dry swab.
Do not use a solvent such as acetone.
- (5) Set the forward electrode again.

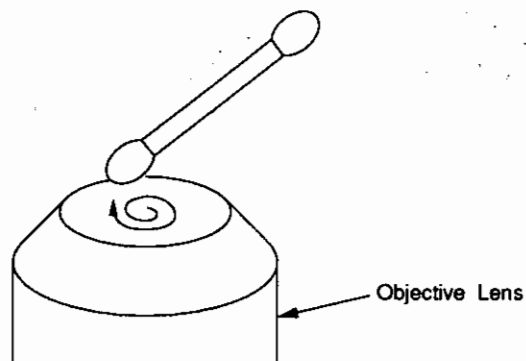

A-6-4 Cleaning LED

Keep the light emitting portion of LED clean. If dirt is adhered to the LED, an error may occur during image processing.

- (1) Open the hood.
- (2) As shown in the figure below, use a cotton swab soaked in 99.5 percent or purer alcohol to clean the illuminator.
Do not use a solvent such as acetone.

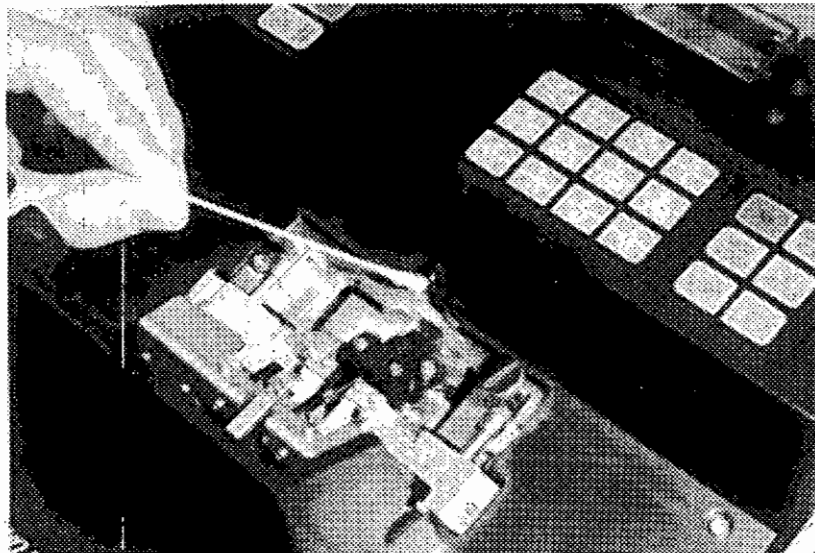

A-6-5 Replacement of electrode

Procedure

- (1) Push RESET.
- (2) Set the power switch to OFF.
- (3) Open the hood
- (4) Loosen screws securing the electrode to take out the electrode. Insert the new pair of electrode and tighten screws evenly.

Note: Do not over-tighten the screws because the electrode holder is made of plastic.

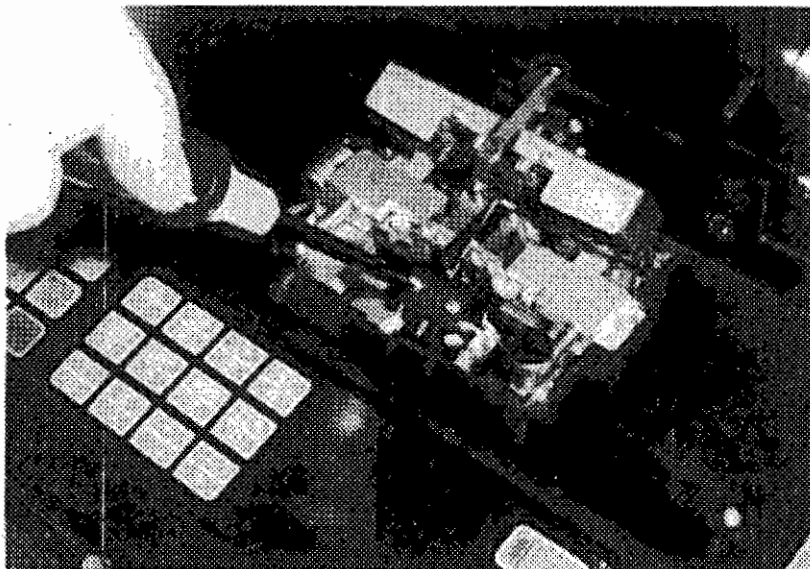

- (5) Perform warm-up 30 times after the electrode is replaced. To perform automatic warm-up with TYPE 35 SE, select warm-up maintenance mode on the mode menu selection screen.

Refer to A-3-7-5.

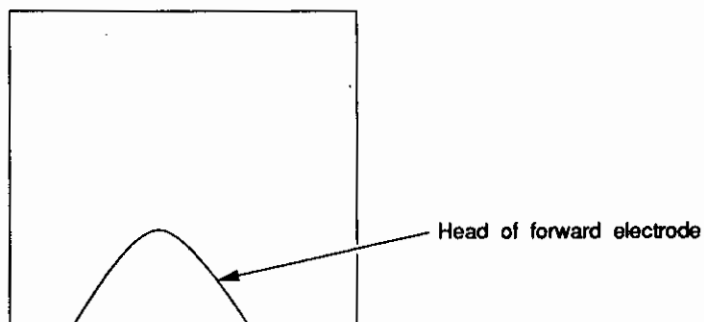

Note: The head of backward electrode cannot be seen with this method.

A-7 Error Message List

Error Message	Description	Action
<p>Set error (L)</p> <p>(R)</p> <p>(L, R)</p>	<p>Wrong setting of left fiber or dirt adhered to the fiber.</p> <p>Wrong setting of right fiber or dirt adhered to the fiber.</p> <p>Wrong setting of both fibers or dirt adhered to the fibers.</p>	<p>Clean the V-groove or the fiber, or reset the fiber.</p>
<p>Dust error (L)</p> <p>(R)</p> <p>(L, R)</p>	<p>Dirt is adhered to left fiber.</p> <p>Dirt is adhered to right fiber.</p> <p>Dirt is adhered to both fibers.</p>	<p>Clean or replace the mirror, or clean the fiber.</p> <p>Checking fiber type SM, MM.</p>
<p>Cut error (L)</p> <p>(R)</p> <p>(L, R)</p>	<p>Left fiber end angle exceeds the set value.</p> <p>Right fiber end angle exceeds the set value.</p> <p>Both fiber end angles exceed the set value.</p>	<p>Cut the fiber end again.</p> <p>Clean the mirror.</p> <p>Replace the mirror.</p>
<p>Exterior error</p>	<p>Joint swelled, thinned, or has become spherical.</p>	<p>Reset the arc conditions.</p> <p>Use arc test.</p>
<p>Parameter error</p> <p>(set value too large)</p> <p>(set value too small)</p>	<p>Invalid value was entered.</p> <p>The entered value exceeds the upper limit.</p> <p>The entered value exceeds the lower limit.</p>	<p>Re-enter the value.</p>
<p>EEPROM error</p>	<p>EEPROM is damaged or data has been deleted.</p>	<p>Repeat power on and off a few times.</p> <p>Voltage low.</p> <p>Contact factory!</p>

Error Message	Description	Action
(ZL F, R) Limit error (ZR F, R) (MSX F, R) (MSY F, R) (VX F, R) (VY F, R) (Mirror F, R)	Drive system reached the limit.	Reset the fiber. Repeat power on and off a few times.
(ZL) Timeout (ZR) (MSX) (MSY) (VX) (VY) (Mirror) (Heater)	An error occurred in drive system.	Repeat power on and off a few times. If the DC battery is defective, check the power supply unit.
(ZL) Sensor error (ZR) (MSX) (MSY) (VX) (VY) (Mirror) (Heater)	Defective drive system sensor	Repeat power on and off a few times.
Heater limit	The Fiber splice was broken, during screening.	Connect the fiber again.
LED Warning	Brightness error.	Clean the LED. Repeat power on and off a few times.
Data storage disabled Inspection data full	Data cannot be stored. (In normal state, 100 data items can be stored.)	Delete old data, before storing new data.

Note: F=Forward limit, R=Reverse limit, ZL=Left chuck, ZR=Right chuck,
 MSX=Microscope vertical axis, MSY=Microscope horizontal axis,
 VX=V groove vertical axis, VY=V groove horizontal axis

History of Revision:

1991 / Dec.	1st version
1992 / Sep.	A version
1993 / Oct.	B version
1994 / May.	C version
1995 / Feb.	D version

Contact.

Tokyo **Sumitomo Electric Industries Ltd. (International Business Division)**
3-12, Moto-Akasaka 1-chome, Minato-ku, Tokyo 107 Japan
Tel: (03-3423-5761), Telex: 28202 SEITOK J, Fax: (03) 3423-5099

North Carolina* **Sumitomo Electric Lightwave Corp.**
78 Alexander Drive, P. O. Box 13445, Research Triangle Park, NC. 27709, U.S.A.
Tel: (919) 541-8100, Fax: (919) 541-8265

London* **Sumitomo Electric Europe S.A. (Edgware Branch)**
Unit 11, Magnolia House, Spring Villa Park, Spring Villa Road, Edgware,
Middlesex, HA8 7EB, U.K.
Tel: (81) 905-6160/6196, Telex: 929043 SEEOPT G, Fax: (81) 905-6195/6196

Hong Kong* **Sumitomo Electric Asia, Ltd.**
Room 3408, Windsor House, 311 Gloucester Road, Causeway Bay, Hong Kong
Tel: (5) 76-0080, Telex: 81627 SEASA HX, Fax: (5) 76-6412

Beijing **Sumitomo Electric Industries, Ltd. (Beijing Office)**
601 Beijing Fortune Building, 5 Dong Sanhuan Bei-Lu,
Chaoyang District, Beijing, China
Tel: (1) 501-3291/3294, Fax: (1) 501-3290

Yokohama* **Connection Systems Engineering Section**
(Engineering **(Communication Division)**
Section) 1 Taya-cho, Sakae-ku, Yokohama, Japan
Tel: (045) 853-7222, Fax: 045-852-7922

*SUMITOMO's maintenance base

Specification subject to change without notification

