



ABN 43 064 478 842

231 Osborne Avenue Clayton South, VIC 3169
PO Box 1548, Clayton South, VIC 3169
t 03 9265 7400 f 03 9558 0875
freecall 1800 680 680
www.tmgtestequipment.com.au

Test & Measurement

- > sales
- > rentals
- > calibration
- > repair
- > disposal

Complimentary Reference Material

This PDF has been made available as a complimentary service for you to assist in evaluating this model for your testing requirements.

TMG offers a wide range of test equipment solutions, from renting short to long term, buying refurbished and purchasing new. Financing options, such as Financial Rental, and Leasing are also available on application.

TMG will assist if you are unsure whether this model will suit your requirements.

Call TMG if you need to organise repair and/or calibrate your unit.

If you click on the "Click-to-Call" logo below, you can call us for FREE!

TMG Corporate Website

TMG Products Website



Click-to-Call
TMG Now



Product Lifecycle Management System

Disclaimer:

All trademarks appearing within this PDF are trademarks of their respective owners.



Operating Manual



Handheld Spectrum Analyzer

R&S[®] FSH4

1309.6000.04

1309.6000.14

1309.6000.24

R&S[®] FSH8

1309.6000.08

1309.6000.18

1309.6000.28



The firmware of the instrument makes use of several valuable open source software packages. The verbatim license texts are provided in on the user documentation CD-ROM (included in delivery). Rohde & Schwarz would like to thank the open source community for their valuable contribution to embedded computing.

Throughout this manual, the Handheld Spectrum Analyzer R&S® FSH is abbreviated as R&S FSH.

R&S® is a registered trademark of Rohde & Schwarz GmbH & Co. KG
Trade names are trademarks of the owners

Contents

Safety Instructions
 Customer Information Regarding Product Disposal
 Safety Regulations for Batteries
 Certificate of Quality
 EC-Certificate of Conformity
 Support Center Address
 List of R&S Representatives

1 Putting into Operation	1.1
2 Getting Started	2.1
3 Operation	3.1
Screen Layout.....	3.1
Screen layout for spectrum-mode measurements without markers	3.1
Screen layout when the marker mode is selected	3.2
Entering Measurement Parameters	3.3
Entering values and texts.....	3.3
Entering units	3.4
Menu Overview	3.5
Softkeys available for all measurement modes	3.5
User settings	3.5
File management	3.5
Tables	3.5
General settings.....	3.6
Selection of the measurement mode	3.6
Softkeys of the spectrum analyzer mode.....	3.7
Frequency entry	3.7
Frequency span	3.7
Level settings	3.7
Bandwidth settings	3.7
Sweep	3.8
Trace settings	3.8
Limit lines	3.8
Measurement functions.....	3.8
Channel power.....	3.9
Occupied Bandwidth.....	3.9
TDMA Power	3.9
Marker	3.10
Marker position	3.10
Softkeys of the network analyzer mode	3.11

Frequency entry	3.11
Frequency span	3.11
Level settings	3.11
Bandwidth settings	3.11
Sweep	3.11
Trace settings	3.12
Limit lines	3.12
Measurement functions.....	3.12
Marker	3.13
Marker position	3.13
Softkeys of the Distance to Fault mode	3.14
Frequency entry	3.14
Frequency span	3.14
Level settings	3.14
Bandwidth settings	3.14
Sweep	3.14
Trace settings	3.15
Measurement functions.....	3.15
Marker	3.15
Marker position	3.15
Softkeys of the Power Meter mode.....	3.16
Frequency entry	3.16
Level settings	3.16
Sweep	3.16
Measurement functions.....	3.16
4 Instrument Functions.....	4.1
Instrument Default Setup.....	4.1
Setting the Frequency.....	4.1
Entering the center frequency.....	4.2
Setting a frequency offset	4.2
Entering the center-frequency step size	4.3
Entering the start and stop frequency.....	4.3
Working with channel tables	4.4
Setting the Span	4.5
Setting the Amplitude Parameters	4.6
Setting the reference level	4.7
Entering the display range	4.8
Entering the display unit.....	4.9
Entering the reference offset	4.9
Entering of the RF-Attenuation	4.9
Entering the RF preamplification.....	4.10
Entering the input impedance	4.10

Selecting a transducer factor	4.10
Setting the Bandwidths	4.12
Resolution bandwidth.....	4.12
Video bandwidth.....	4.13
Setting the Sweep.....	4.15
Sweep time	4.15
Sweep mode	4.16
Trigger	4.16
Trace Settings.....	4.18
Trace mode.....	4.18
Detector	4.19
Trace-Selection.....	4.21
Trace memory.....	4.22
Trace mathematics	4.23
Using the Markers	4.23
Automatic marker positioning	4.25
Using more than one marker at a time (multimarker mode).....	4.27
Marker functions	4.29
Measuring the noise power density.....	4.29
Measuring the frequency.....	4.30
AF demodulation.....	4.31
Using the Display Line	4.32
Using Limit Lines.....	4.32
Measurements with limit lines	4.34
Definition range of limit lines	4.35
Data sets containing limit lines.....	4.35
Setting and Using the Measurement Functions.....	4.35
Measuring the channel power of continuously modulated signals	4.35
Selecting the standard	4.36
Setting the reference level	4.37
Setting the channel bandwidth	4.37
Changing the span.....	4.37
Unit for power display.....	4.39
Power measurements on TDMA signals	4.39
Selecting a standard	4.40
Setting the burst length	4.40

Optimizing the reference level	4.41
Power readout.....	4.41
Setting the trigger.....	4.41
Measuring the occupied bandwidth	4.42
Selecting a standard	4.43
Setting the reference level	4.43
Setting the channel bandwidth.....	4.44
Entering the power percent to determine the occupied bandwidth	4.44
Displaying the occupied bandwidth.....	4.45
Changing the span.....	4.45
Two-port measurements with the tracking generator	4.45
Measuring the transmission of two-ports	4.48
Vector measurement.....	4.50
Vector transmission measurement	4.52
Measuring the transmission magnitude	4.54
Measuring the transmission phase (models with integrated VSWR bridge only)	4.54
Supplying DC voltage to active DUTs (models with integrated VSWR bridge only)	4.55
Scalar measurement of reflection	4.55
Vector measurement of reflection.....	4.58
Measuring the reflection magnitude.....	4.59
Measuring the reflection phase.....	4.60
Simultaneous measurement of magnitude and phase of the reflection.....	4.60
Displaying the reflection in the Smith chart.....	4.61
Selecting the calibration standards:	4.64
Cable Measurements.....	4.66
Cable selection	4.67
Selecting the frequency range	4.68
Calibrating the test setup	4.69
Measurements using the power sensor.....	4.72
Connecting the power sensor	4.72
Zeroing the power sensor	4.74
Selecting the unit for the power readout	4.75
Setting the averaging time	4.75
Taking additional loss or gain into account.....	4.76
Measuring forward and reflected power	4.76
Zeroing the power sensor	4.79
Setting the power measurement weighting.....	4.80
Selecting the unit for the power readout	4.80
Taking additional attenuation into account.....	4.81

Measuring with Transducer Factors.....4.83

- Unit for measurements with transducers4.85
- Reference level settings for measurements with transducers4.85
- Frequency range of transducer4.86
- Data sets containing transducer factors4.86

Saving and Loading Instrument Settings and Measurement Results.....4.87

- Saving results4.88
- Entering a data set name.....4.88
- Loading measurement results4.89

Measurements4.90

- How a spectrum analyzer operates4.90

Safety Instructions



Make sure to read through and observe the following safety instructions!

All plants and locations of the Rohde & Schwarz group of companies make every effort to keep the safety standard of our products up to date and to offer our customers the highest possible degree of safety. Our products and the auxiliary equipment required for them are designed and tested in accordance with the relevant safety standards. Compliance with these standards is continuously monitored by our quality assurance system. The product described here has been designed and tested in accordance with the EC Certificate of Conformity and has left the manufacturer's plant in a condition fully complying with safety standards. To maintain this condition and to ensure safe operation, observe all instructions and warnings provided in this manual. If you have any questions regarding these safety instructions, the Rohde & Schwarz group of companies will be happy to answer them.

Furthermore, it is your responsibility to use the product in an appropriate manner. This product is designed for use solely in industrial and laboratory environments or, if expressly permitted, also in the field and must not be used in any way that may cause personal injury or property damage. You are responsible if the product is used for an intention other than its designated purpose or in disregard of the manufacturer's instructions. The manufacturer shall assume no responsibility for such use of the product.

The product is used for its designated purpose if it is used in accordance with its product documentation and within its performance limits (see data sheet, documentation, the following safety instructions). Using the product requires technical skills and a basic knowledge of English. It is therefore essential that only skilled and specialized staff or thoroughly trained personnel with the required skills be allowed to use the product. If personal safety gear is required for using Rohde & Schwarz products, this will be indicated at the appropriate place in the product documentation. Keep the basic safety instructions and the product documentation in a safe place and pass them on to the subsequent users.

Symbols and safety labels:

						
Observe product documentation	Danger of electric shock	Warning! Hot surface	PE terminal	Ground	Ground terminal	Attention! Electrostatic sensitive devices

Observing the safety instructions will help prevent personal injury or damage of any kind caused by dangerous situations. Therefore, carefully read through and adhere to the following safety instructions before putting the product into operation. It is also absolutely essential to observe the additional safety instructions on personal safety that appear in relevant parts of the product documentation. In these safety instructions, the word "product" refers to all merchandise sold and distributed by the Rohde & Schwarz group of companies, including instruments, systems and all accessories.

Tags and their meaning

DANGER	DANGER indicates a hazardous situation which, if not avoided, will result in death or serious injury.
WARNING	WARNING indicates a hazardous situation which, if not avoided, could result in death or serious injury.
CAUTION	CAUTION indicates a hazardous situation which, if not avoided, may result in minor or moderate injury.
NOTICE	NOTICE indicates a property damage message. In the product documentation, the word ATTENTION is used synonymously.

These tags are in accordance with the standard definition for civil applications in the European Economic Area. Definitions that deviate from the standard definition may also exist in other economic areas or military applications. It is therefore essential to make sure that the tags described here are always used only in connection with the related product documentation and the related product. The use of tags in connection with unrelated products or documentation can result in misinterpretation and thus contribute to personal injury or material damage.

Basic safety instructions

1. The product may be operated only under the operating conditions and in the positions specified by the manufacturer. The R&S FSH is protected against dripping water and dust (IP degree 51). Unless otherwise specified, the following requirements apply to Rohde & Schwarz products: prescribed operating position is always with the housing floor facing down, IP protection 2X, pollution severity 2, overvoltage category 2, use only in enclosed spaces, max. operation altitude 4600 m above sea level, max. transport altitude 12000 m above sea level. A tolerance of $\pm 10\%$ shall apply to the nominal voltage and of $\pm 5\%$ to the nominal frequency.
2. Applicable local or national safety regulations and rules for the prevention of accidents must be observed in all work performed. The product may be opened only by authorized, specially trained personnel. Prior to performing any work on the product or opening the product, the product must be disconnected from the supply network. Any adjustments, replacements of parts, maintenance or repair must be carried out only by technical personnel authorized by Rohde & Schwarz. Only original parts may be used for replacing parts relevant to safety (e.g. power switches, power transformers, fuses, batteries). A safety test must always be performed after parts relevant to safety have been replaced (visual inspection, PE conductor test, insulation resistance measurement, leakage current measurement, functional test).
3. As with all industrially manufactured goods, the use of substances that induce an allergic reaction (allergens, e.g. nickel) such as aluminum cannot be generally excluded. If you develop an allergic reaction (such as a skin rash, frequent sneezing, red eyes or respiratory difficulties), consult a physician immediately to determine the cause.
4. If products/components are mechanically and/ or thermally processed in a manner that goes beyond their intended use, hazardous substances (heavy-metal dust such as lead, beryllium, nickel) may be released. For this reason, the product may only be disassembled, e.g. for disposal purposes, by specially trained personnel. Improper disassembly may be hazardous to your health. National waste disposal regulations must be observed.
5. Depending on the function, certain products such as RF radio equipment can produce an elevated level of electromagnetic radiation. Considering that unborn life requires increased protection, pregnant women should be protected by appropriate measures. Persons with pacemakers may also be endangered by electromagnetic radiation. The employer/ operator is required to assess workplaces where there is a

special risk of exposure to radiation and, if necessary, take measures to avert the danger.

6. Operating the products requires special training and intense concentration. Make certain that persons who use the products are physically, mentally and emotionally fit enough to handle operating the products; otherwise injuries or material damage may occur. It is the responsibility of the employer to select suitable personnel for operating the products.
7. Prior to switching on the product, it must be ensured that the nominal voltage setting on the power supply matches the nominal voltage of the AC supply network.
8. If the product has no power switch for disconnection from the AC supply, the plug of the connecting cable is regarded as the disconnecting device. In such cases, it must be ensured that the power plug is easily reachable and accessible at all times (corresponding to the length of connecting cable, approx. 2 m). Functional or electronic switches are not suitable for providing disconnection from the AC supply. If products without power switches are integrated in racks or systems, a disconnecting device must be provided at the system level.
9. Never use the product if the power cable is damaged. Check the power cable on a regular basis to ensure that it is in proper operating condition. By taking appropriate safety measures and carefully laying the power cable, ensure that the cable cannot be damaged and that no one can be hurt by e.g. tripping over the cable or suffering an electric shock.
10. The product may be operated only from TN/TT supply networks fused with max. 16 A (higher fuse only after consulting with the Rohde & Schwarz group of companies).
11. Do not insert the plug into sockets that are dusty or dirty. Insert the plug firmly and all the way into the socket. Otherwise, this can result in sparks, fire and/or injuries.
12. Do not overload any sockets, extension cords or connector strips; doing so can cause fire or electric shocks.
13. For measurements in circuits with voltages $V_{rms} > 30 V$, suitable measures (e.g. appropriate measuring equipment, fusing, current limiting, electrical separation, insulation) should be taken to avoid any hazards.
14. Ensure that the connections with information technology equipment comply with IEC 950/EN 60950.
15. Unless expressly permitted, never remove the cover or any part of the housing while the product is in operation. Doing so will expose circuits and components and can lead to injuries, fire or damage to the product.
16. For permanently installed equipment without built-in fuses, circuit breakers or similar protective devices, the supply circuit must be fused in such a way that suitable protection is provided for users and products.
17. Do not insert any objects into the openings in the housing that are not designed for this purpose. Never pour any liquids onto or into the housing. This can cause short circuits inside the product and/or electric shocks, fire or injuries.
18. Use suitable overvoltage protection to ensure that no overvoltage (such as that caused by a thunderstorm) can reach the product. Otherwise the operating personnel will be endangered by electric shocks.
19. Do not place the product on heat-generating devices such as radiators or fan heaters. The temperature of the environment must not exceed the maximum temperature specified in the data sheet.
20. Batteries and storage batteries must not be exposed to high temperatures or fire. Keep batteries and storage batteries away from children. Do not short-circuit batteries and storage batteries. If batteries or storage batteries are improperly replaced, this can cause an explosion (warning: lithium cells). Replace the battery or storage battery only with the matching Rohde & Schwarz type (see spare parts list). Batteries and storage batteries must be recycled and kept separate from residual waste. Batteries and storage batteries that contain lead, mercury or cadmium are hazardous waste. Observe the national regulations regarding waste disposal and recycling.

21. Please be aware that in the event of a fire, toxic substances (gases, liquids etc.) that may be hazardous to your health may escape from the product.
22. Handles on the products are designed exclusively for personnel to hold or carry the product. It is therefore not permissible to use handles for fastening the product to or on means of transport such as cranes, fork lifts, wagons, etc. The user is responsible for securely fastening the products to or on the means of transport and for observing the safety regulations of the manufacturer of the means of transport. Noncompliance can result in personal injury or material damage.
23. If you use the product in a vehicle, it is the sole responsibility of the driver to drive the vehicle safely. Adequately secure the product in the vehicle to prevent injuries or other damage in the event of an accident. Never use the product in a moving vehicle if doing so could distract the driver of the vehicle. The driver is always responsible for the safety of the vehicle. The manufacturer assumes no responsibility for accidents or collisions.
24. Prior to cleaning, disconnect the product from the AC supply. Use a soft, non-linting cloth to clean the product. Never use chemical cleaning agents such as alcohol, acetone or diluent for cellulose lacquers.
25. Any additional safety instructions given in this manual are also to be observed.

Informaciones Elementales de Seguridad







¡Es imprescindible leer y observar las siguientes instrucciones e informaciones de seguridad!

El principio del grupo de empresas Rohde & Schwarz consiste en tener nuestros productos siempre al día con los estándares de seguridad y de ofrecer a nuestros clientes el máximo grado de seguridad. Nuestros productos y todos los equipos adicionales son siempre fabricados y examinados según las normas de seguridad vigentes. Nuestra sección de gestión de la seguridad de calidad controla constantemente que sean cumplidas estas normas. El presente producto ha sido fabricado y examinado según el comprobante de conformidad adjunto según las normas de la CE y ha salido de nuestra planta en estado impecable según los estándares técnicos de seguridad. Para poder preservar este estado y garantizar un funcionamiento libre de peligros, el usuario deberá atenerse a todas las indicaciones, informaciones de seguridad y notas de alerta. El grupo de empresas Rohde & Schwarz está siempre a su disposición en caso de que tengan preguntas referentes a estas informaciones de seguridad.

Además queda en la responsabilidad del usuario utilizar el producto en la forma debida. Este producto está destinado exclusivamente al uso en la industria y el laboratorio o, si ha sido expresamente autorizado, para aplicaciones de campo y de ninguna manera deberá ser utilizado de modo que alguna persona/cosa pueda sufrir daño. El uso del producto fuera de sus fines definidos o despreciando las informaciones de seguridad del fabricante queda en la responsabilidad del usuario. El fabricante no se hace en ninguna forma responsable de consecuencias a causa del mal uso del producto.

Se parte del uso correcto del producto para los fines definidos si el producto es utilizado dentro de las instrucciones de la correspondiente documentación de producto y dentro del margen de rendimiento definido (ver hoja de datos, documentación, informaciones de seguridad que siguen). El uso del producto hace necesarios conocimientos profundos y conocimientos básicas del idioma inglés. Por eso se debe tener en cuenta que el producto sólo pueda ser operado por personal especializado o personas minuciosamente instruidas con las capacidades correspondientes. Si fuera necesaria indumentaria de seguridad para el uso de productos de R&S, encontrará la información debida en la documentación del producto en el capítulo correspondiente. Guarde bien las informaciones de seguridad elementales, así como la documentación del producto y entréguela a usuarios posteriores.

Símbolos y definiciones de seguridad

						
Ver documentación de producto	Peligro de golpe de corriente	¡Advertencia! Superficie caliente	Conexión a conductor protector	Conexión a tierra	Conexión a masa conductora	¡Cuidado! Elementos de construcción con peligro de carga electrostática

Tener en cuenta las informaciones de seguridad sirve para tratar de evitar daños y peligros de toda clase. Es necesario de que se lean las siguientes informaciones de seguridad concienzudamente y se tengan en cuenta debidamente antes de la puesta en funcionamiento del producto. También deberán ser tenidas en cuenta las informaciones para la protección de personas que encontrarán en el capítulo correspondiente de la documentación de producto y que también son obligatorias de seguir. En las informaciones de seguridad actuales hemos juntado todos los objetos vendidos por el grupo de empresas Rohde & Schwarz bajo la denominación de „producto“, entre ellos también aparatos, instalaciones así como toda clase de accesorios.

Palabras de señal y su significado

PELIGRO	Identifica un peligro directo con riesgo elevado de provocar muerte o lesiones de gravedad si no se toman las medidas oportunas.
ADVERTENCIA	Identifica un posible peligro con riesgo medio de provocar muerte o lesiones (de gravedad) si no se toman las medidas oportunas.
ATENCIÓN	Identifica un peligro con riesgo reducido de provocar lesiones de gravedad media o leve si no se toman las medidas oportunas.
AVISO	Indica la posibilidad de utilizar mal el producto y a consecuencia dañarlo. En la documentación del producto se emplea de forma sinónima el término CUIDADO.

Las palabras de señal corresponden a la definición habitual para aplicaciones civiles en el área económica europea. Pueden existir definiciones diferentes a esta definición en otras áreas económicas o en aplicaciones militares. Por eso se deberá tener en cuenta que las palabras de señal aquí descritas sean utilizadas siempre solamente en combinación con la correspondiente documentación de producto y solamente en combinación con el producto correspondiente. La utilización de las palabras de señal en combinación con productos o documentaciones que no les correspondan puede llevar a malinterpretaciones y tener por consecuencia daños en personas u objetos.

Informaciones de seguridad elementales

- El producto solamente debe ser utilizado según lo indicado por el fabricante referente a la situación y posición de funcionamiento. R&S FSH está protegido contra roción y polvo (modo de protección IP 51). Si no se convino de otra manera, es para los productos R&S válido lo que sigue: como posición de funcionamiento se define por principio la posición con el suelo de la caja para abajo, modo de protección IP 2X, grado de suciedad 2, categoría de sobrecarga eléctrica 2, utilizar solamente en estancias interiores, utilización hasta 4600 m sobre el nivel del mar, transporte hasta 12000 m sobre el nivel del mar. Se aplicará una tolerancia de $\pm 10\%$ sobre el voltaje nominal y de $\pm 5\%$ sobre la frecuencia nominal.
- En todos los trabajos deberán ser tenidas en cuenta las normas locales de seguridad de trabajo y de prevención de accidentes. El producto solamente debe de ser abierto por personal especializado autorizado. Antes de efectuar trabajos en el producto o abrirlo deberá este ser desconectado de la corriente. El ajuste, el cambio de partes, la manutención y la reparación deberán ser solamente efectuadas por electricistas autorizados por R&S. Si se reponen partes con importancia para los aspectos de seguridad (por ejemplo el enchufe, los transformadores o los fusibles, baterías), solamente podrán ser sustituidos por partes originales. Después de cada recambio de partes elementales para la seguridad deberá ser efectuado un control de seguridad (control a primera vista, control de conductor protector, medición de resistencia de aislamiento, medición de la corriente conductora, control de funcionamiento).
- Como en todo producto de fabricación industrial no puede ser excluido en general de que se produzcan al usarlo elementos que puedan generar alergias, los llamados elementos alergénicos (por ejemplo el níquel). Si se produjeran en el trato con productos R&S reacciones alérgicas, como por ejemplo urticaria, estornudos frecuentes, irritación de la conjuntiva o dificultades al respirar, se deberá consultar inmediatamente a un médico para averiguar los motivos de estas reacciones.
- Si productos / elementos de construcción son tratados fuera del funcionamiento definido de forma mecánica o térmica, pueden generarse elementos peligrosos (polvos de sustancia de metales pesados como por ejemplo plomo, berilio, níquel). La partición elemental del producto, como por ejemplo sucede en el tratamiento de materias residuales, debe de ser efectuada solamente por personal especializado para estos tratamientos. La partición elemental efectuada inadecuadamente puede generar daños para la salud. Se deben tener en

cuenta las directivas nacionales referentes al tratamiento de materias residuales.

5. Ciertos productos, como por ejemplo las instalaciones de radiocomunicación RF, pueden a causa de su función natural, emitir una radiación electromagnética aumentada. En vista a la protección de la vida en desarrollo deberían ser protegidas personas embarazadas debidamente. También las personas con un bypass pueden correr peligro a causa de la radiación electromagnética. El empresario/ usuario está comprometido a valorar y señalar áreas de trabajo en las que se corra un riesgo aumentado de exposición a radiaciones para evitar riesgos.
6. La utilización de los productos requiere instrucciones especiales y una alta concentración en el manejo. Debe de ponerse por seguro de que las personas que manejen los productos estén a la altura de los requerimientos necesarios referente a sus aptitudes físicas, psíquicas y emocionales, ya que de otra manera no se pueden excluir lesiones o daños de objetos. El empresario lleva la responsabilidad de seleccionar el personal usuario apto para el manejo de los productos.
7. Antes de la puesta en marcha del producto se deberá tener por seguro de que la tensión preseleccionada en el fuente alimentación equivalga a la del la red de distribución.
8. Si el producto no está equipado con un interruptor para desconectarlo de la red, se deberá considerar el enchufe del cable de distribución como interruptor. En estos casos deberá asegurar de que el enchufe sea de fácil acceso y nabejo (según la medida del cable de distribución, aproximadamente 2 m). Los interruptores de función o electrónicos no son aptos para el corte de la red eléctrica. Si los productos sin interruptor están integrados en bastidores o instalaciones, se deberá instalar el interruptor al nivel de la instalación.
9. No utilice nunca el producto si está dañado el cable eléctrico. Compruebe regularmente el correcto estado de los cables de conexión a red. Asegure a través de las medidas de protección y de instalación adecuadas de que el cable de eléctrico no pueda ser dañado o de que nadie pueda ser dañado por él, por ejemplo al tropezar o por un golpe de corriente.
10. Solamente está permitido el funcionamiento en redes de distribución TN/TT aseguradas con fusibles de como máximo 16 A (utilización de fusibles de mayor amperaje sólo previa consulta con el grupo de empresas Rohde & Schwarz).
11. Nunca conecte el enchufe en tomas de corriente sucias o llenas de polvo. Introduzca el enchufe por completo y fuertemente en la toma de corriente. Si no tiene en consideración estas indicaciones se arriesga a que se originen chispas, fuego y/o heridas.
12. No sobrecargue las tomas de corriente, los cables de extensión o los enchufes de extensión ya que esto pudiera causar fuego o golpes de corriente.
13. En las mediciones en circuitos de corriente con una tensión de entrada de $U_{eff} > 30 V$ se deberá tomar las precauciones debidas para impedir cualquier peligro (por ejemplo medios de medición adecuados, seguros, limitación de tensión, corte protector, aislamiento etc.).
14. En caso de conexión con aparatos de la técnica informática se deberá tener en cuenta que estos cumplan los requisitos del estándar IEC950/EN60950.
15. A menos que esté permitido expresamente, no retire nunca la tapa ni componentes de la carcasa mientras el producto esté en servicio. Esto pone a descubierto los cables y componentes eléctricos y puede causar heridas, fuego o daños en el producto.
16. En caso de que los productos que son instalados fijamente en un lugar sean sin protector implementado, autointerruptor o similares objetos de protección, el circuito de suministro de corriente deberá estar protegido de manera que usuarios y productos estén suficientemente protegidos.
17. Por favor, no introduzca ningún objeto que no esté destinado a ello en los orificios de la caja del aparato. No vierta nunca ninguna clase de líquidos sobre o en la caja. Esto puede producir cortocircuitos en el producto y/o puede causar golpes de corriente, fuego o heridas.

18. Asegúrese con la protección adecuada de que no pueda originarse en el producto una sobrecarga por ejemplo a causa de una tormenta. Si no se verá el personal que lo utilice expuesto al peligro de un golpe de corriente.
19. No ponga el producto sobre aparatos que produzcan calor, como por ejemplo radiadores o calentadores. La temperatura ambiental no debe superar la temperatura máxima especificada en la hoja de datos.
20. Baterías y acumuladores no deben de ser expuestos a temperaturas altas o al fuego. Guardar baterías y acumuladores fuera del alcance de los niños. No cortocircuitar baterías ni acumuladores. Si las baterías o los acumuladores no son cambiados con la debida atención existirá peligro de explosión (atención células de litio). Cambiar las baterías o los acumuladores solamente por los del tipo R&S correspondiente (ver lista de piezas de recambio). Las baterías y acumuladores deben reutilizarse y no deben acceder a los vertederos. Las baterías y acumuladores que contienen plomo, mercurio o cadmio deben tratarse como residuos especiales. Respete en esta relación las normas nacionales de evacuación y reciclaje.
21. Por favor tengan en cuenta que en caso de un incendio pueden desprenderse del producto agentes venenosos (gases, líquidos etc.) que pueden generar daños a la salud.
22. Las asas instaladas en los productos sirven solamente de ayuda para el manejo que solamente está previsto para personas. Por eso no está permitido utilizar las asas para la sujeción en o sobre medios de transporte como por ejemplo grúas, carretillas elevadoras de horquilla, carros etc. El usuario es responsable de que los productos sean sujetados de forma segura a los medios de transporte y de que las prescripciones de seguridad del fabricante de los medios de transporte sean observadas. En caso de que no se tengan en cuenta pueden causarse daños en personas y objetos.
23. Si llega a utilizar el producto dentro de un vehículo, queda en la responsabilidad absoluta del conductor que conducir el vehículo de manera segura. Asegure el producto dentro del vehículo debidamente para evitar en caso de un accidente las lesiones u otra clase de daños. No utilice nunca el producto dentro de un vehículo en movimiento si esto pudiera distraer al conductor. Siempre queda en la responsabilidad absoluta del conductor la seguridad del vehículo. El fabricante no asumirá ninguna clase de responsabilidad por accidentes o colisiones.
24. Antes de proceder a la limpieza, desconecte el producto de la red. Realice la limpieza con un paño suave, que no se deshilache. No utilice de ninguna manera agentes limpiadores químicos como, por ejemplo, alcohol, acetona o nitrodiluyente.
25. Deben observarse las indicaciones de seguridad adicionales del presente manual.

Customer Information Regarding Product Disposal

The German Electrical and Electronic Equipment (ElektroG) Act is an implementation of the following EC directives:

- 2002/96/EC on waste electrical and electronic equipment (WEEE) and
- 2002/95/EC on the restriction of the use of certain hazardous substances in electrical and electronic equipment (RoHS).

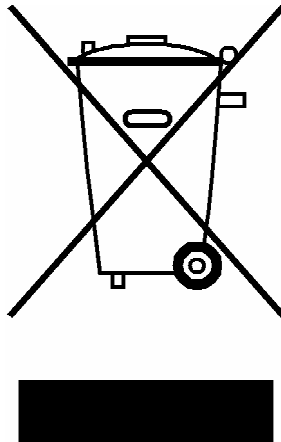

Product labeling in accordance with EN 50419

Once the lifetime of a product has ended, this product must not be disposed of in the standard domestic refuse. Even disposal via the municipal collection points for waste electrical and electronic equipment is not permitted.

Rohde & Schwarz GmbH & Co. KG has developed a disposal concept for the environmental-friendly disposal or recycling of waste material and fully assumes its obligation as a producer to take back and dispose of electrical and electronic waste in accordance with the ElektroG Act.

Please contact your local service representative to dispose of the product.





ROHDE & SCHWARZ

Kundeninformation zur Batterieverordnung (BattV)

Dieses Gerät enthält eine schadstoffhaltige Batterie. Diese darf nicht mit dem Hausmüll entsorgt werden.

Nach Ende der Lebensdauer darf die Entsorgung nur über eine Rohde&Schwarz-Kundendienststelle oder eine geeignete Sammelstelle erfolgen.

Safety Regulations for Batteries (according to BattV)

This equipment houses a battery containing harmful substances that must not be disposed of as normal household waste.

After its useful life, the battery may only be disposed of at a Rohde & Schwarz service center or at a suitable depot.

Normas de Seguridad para Baterías (Según BattV)

Este equipo lleva una batería que contiene sustancias perjudiciales, que no se debe desechar en los contenedores de basura domésticos.

Después de la vida útil, la batería sólo se podrá eliminar en un centro de servicio de Rohde & Schwarz o en un depósito apropiado.

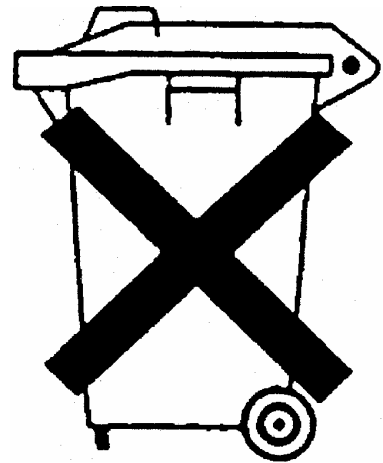

Consignes de sécurité pour batteries (selon BattV)

Cet appareil est équipé d'une pile comprenant des substances nocives. Ne jamais la jeter dans une poubelle pour ordures ménagères.

Une pile usagée doit uniquement être éliminée par un centre de service client de Rohde & Schwarz ou peut être collectée pour être traitée spécialement comme déchets dangereux.

Certified Quality System

DIN EN ISO 9001 : 2000
DIN EN 9100 : 2003
DIN EN ISO 14001 : 2004

DQS REG. NO 001954 QM UM

QUALITÄTSZERTIFIKAT

Sehr geehrter Kunde,
Sie haben sich für den Kauf eines Rohde & Schwarz-Produktes entschieden. Hiermit erhalten Sie ein nach modernsten Fertigungsmethoden hergestelltes Produkt. Es wurde nach den Regeln unseres Managementsystems entwickelt, gefertigt und geprüft. Das Rohde & Schwarz Managementsystem ist zertifiziert nach:

DIN EN ISO 9001:2000
DIN EN 9100:2003
DIN EN ISO 14001:2004

CERTIFICATE OF QUALITY

Dear Customer,
you have decided to buy a Rohde & Schwarz product. You are thus assured of receiving a product that is manufactured using the most modern methods available. This product was developed, manufactured and tested in compliance with our quality management system standards. The Rohde & Schwarz quality management system is certified according to:

DIN EN ISO 9001:2000
DIN EN 9100:2003
DIN EN ISO 14001:2004

CERTIFICAT DE QUALITÉ

Cher Client,
vous avez choisi d'acheter un produit Rohde & Schwarz. Vous disposez donc d'un produit fabriqué d'après les méthodes les plus avancées. Le développement, la fabrication et les tests respectent nos normes de gestion qualité. Le système de gestion qualité de Rohde & Schwarz a été homologué conformément aux normes:

DIN EN ISO 9001:2000
DIN EN 9100:2003
DIN EN ISO 14001:2004





Certificate No.: 2008-45

This is to certify that:

Equipment type	Stock No.	Designation
FSH4	1309.6000.04/.14/.24	Handheld Spectrum Analyzer
FSH8	1309.6000.08/.18/.28	
FSH-Z1	1155.4505.02	Average Power Sensor
FSH-Z14	1120.6001.02	Directional Power Sensor
FSH-Z18	1165.1909.02	Average Power Sensor
FSH-Z44	1165.2305.02	Directional Power Sensor

complies with the provisions of the Directive of the Council of the European Union on the approximation of the laws of the Member States

- relating to electrical equipment for use within defined voltage limits (2006/95/EC)
- relating to electromagnetic compatibility (2004/108/EC)

Conformity is proven by compliance with the following standards:

EN 61010-1 : 2001
EN 61326 : 1997 + A1 : 1998 + A2 : 2001 + A3 : 2003
EN 55011 : 1998 + A1 : 1999 + A2 : 2002, Klasse B
EN 61000-3-2 : 2000 + A2 : 2005
EN 61000-3-3 : 1995 + A1 : 2001

For the assessment of electromagnetic compatibility, the limits of radio interference for Class B equipment as well as the immunity to interference for operation in industry have been used as a basis.

Affixing the EC conformity mark as from 2008

ROHDE & SCHWARZ GmbH & Co. KG
Mühlendorfstr. 15, D-81671 München

Munich, 2008-09-10

Central Quality Management MF-QZ / Radde

Customer Support

Technical support – where and when you need it

For quick, expert help with any Rohde & Schwarz equipment, contact one of our Customer Support Centers. A team of highly qualified engineers provides telephone support and will work with you to find a solution to your query on any aspect of the operation, programming or applications of Rohde & Schwarz equipment.

Up-to-date information and upgrades

To keep your instrument up-to-date and to be informed about new application notes related to your instrument, please send an e-mail to the Customer Support Center stating your instrument and your wish. We will take care that you will get the right information.

USA & Canada

Monday to Friday (except US public holidays)
8:00 AM – 8:00 PM Eastern Standard Time (EST)

Tel. from USA 888-test-rsa (888-837-8772) (opt 2)
From outside USA +1 410 910 7800 (opt 2)
Fax +1 410 910 7801

E-mail CustomerSupport@rohde-schwarz.com

East Asia

Monday to Friday (except Singaporean public holidays)
8:30 AM – 6:00 PM Singapore Time (SGT)

Tel. +65 6 513 0488
Fax +65 6 846 1090

E-mail CustomerSupport@rohde-schwarz.com

Rest of the World

Monday to Friday (except German public holidays)
08:00 – 17:00 Central European Time (CET)

Tel. from Europe +49 (0) 180 512 42 42*
From outside Europe +49 89 4129 13776
Fax +49 (0) 89 41 29 637 78

E-mail CustomerSupport@rohde-schwarz.com

* 0.14 €/Min within the German fixed-line telephone network, varying prices for the mobile telephone network and in different countries.



Address List

Headquarters, Plants and Subsidiaries

Headquarters

ROHDE & SCHWARZ GmbH & Co. KG
Mühlendorfstraße 15 · D-81671 München
P.O.Box 80 14 69 · D-81614 München

Phone +49 (89) 41 29-0
Fax +49 (89) 41 29-121 64
info.rs@rohde-schwarz.com

Plants

ROHDE & SCHWARZ Messgerätebau GmbH
Riedbachstraße 58 · D-87700 Memmingen
P.O.Box 16 52 · D-87686 Memmingen

Phone +49 (83 31) 1 08-0
+49 (83 31) 1 08-1124
info.rsmb@rohde-schwarz.com

ROHDE & SCHWARZ GmbH & Co. KG
Werk Teisnach
Kaikenrieder Straße 27 · D-94244 Teisnach
P.O.Box 11 49 · D-94240 Teisnach

Phone +49 (99 23) 8 50-0
Fax +49 (99 23) 8 50-174
info.rsdt@rohde-schwarz.com

ROHDE & SCHWARZ závod
Vimperk, s.r.o.
Location Spidrova 49
CZ-38501 Vimperk

Phone +420 (388) 45 21 09
Fax +420 (388) 45 21 13

ROHDE & SCHWARZ GmbH & Co. KG
Dienstleistungszentrum Köln
Graf-Zeppelin-Straße 18 · D-51147 Köln
P.O.Box 98 02 60 · D-51130 Köln

Phone +49 (22 03) 49-0
Fax +49 (22 03) 49 51-229
info.rsdc@rohde-schwarz.com
service.rsdc@rohde-schwarz.com

Subsidiaries

R&S BICK Mobilfunk GmbH
Fritz-Hahne-Str. 7 · D-31848 Bad Münder
P.O.Box 20 02 · D-31844 Bad Münder

Phone +49 (50 42) 9 98-0
Fax +49 (50 42) 9 98-105
info.bick@rohde-schwarz.com

ROHDE & SCHWARZ FTK GmbH
Wendenschloßstraße 168, Haus 28
D-12557 Berlin

Phone +49 (30) 658 91-122
Fax +49 (30) 655 50-221
info.ftk@rohde-schwarz.com

ROHDE & SCHWARZ SIT GmbH
Am Studio 3
D-12489 Berlin

Phone +49 (30) 658 84-0
Fax +49 (30) 658 84-183
info.sit@rohde-schwarz.com

R&S Systems GmbH
Graf-Zeppelin-Straße 18
D-51147 Köln

Phone +49 (22 03) 49-5 23 25
Fax +49 (22 03) 49-5 23 36
info.rssys@rohde-schwarz.com

GEDIS GmbH
Sophienblatt 100
D-24114 Kiel

Phone +49 (431) 600 51-0
Fax +49 (431) 600 51-11
sales@gedis-online.de

HAMEG Instruments GmbH
Industriestraße 6
D-63533 Mainhausen

Phone +49 (61 82) 800-0
Fax +49 (61 82) 800-100
info@hameg.de

Locations Worldwide

Please refer to our homepage: www.rohde-schwarz.com

- ◆ Sales Locations
- ◆ Service Locations
- ◆ National Websites

1 Putting into Operation

For details refer to the Quick Start Guide, chapter 1 "Putting into Operation".

2 Getting Started

For details refer to the Quick Start Guide, chapter 2 "Getting Started".

3 Operation

Screen Layout

Screen layout for spectrum-mode measurements without markers

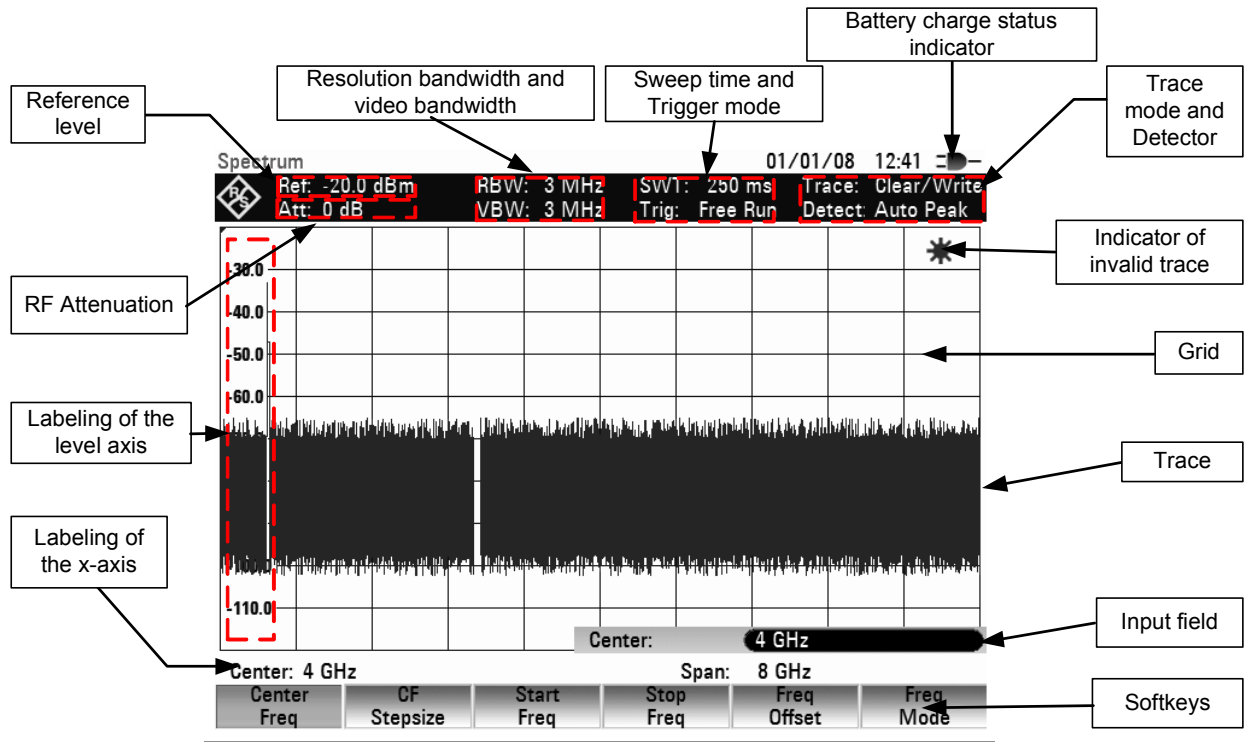

Screen layout when the marker mode is selected

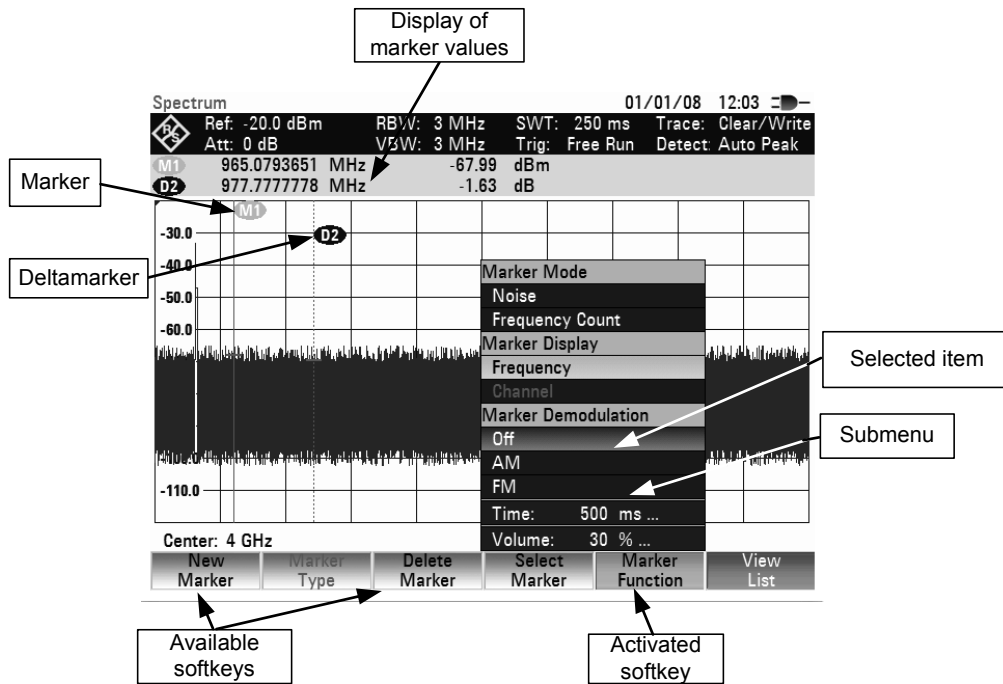

The colour of the softkey labelling and its background indicate the status of the softkey function in question:

Softkey color	Meaning
Gray background, white labeling	Softkey function is turned off
Gray background, gray labeling	In the current setting, this softkey function is not available
Green background	Softkey function is turned on
Red background	Softkey function has been activated for value entry or selecting a menu function

Entering Measurement Parameters

Settings and texts are entered either by directly calling the functions or by entering values, units or texts separately. The R&S FSH has a variety of operating modes.

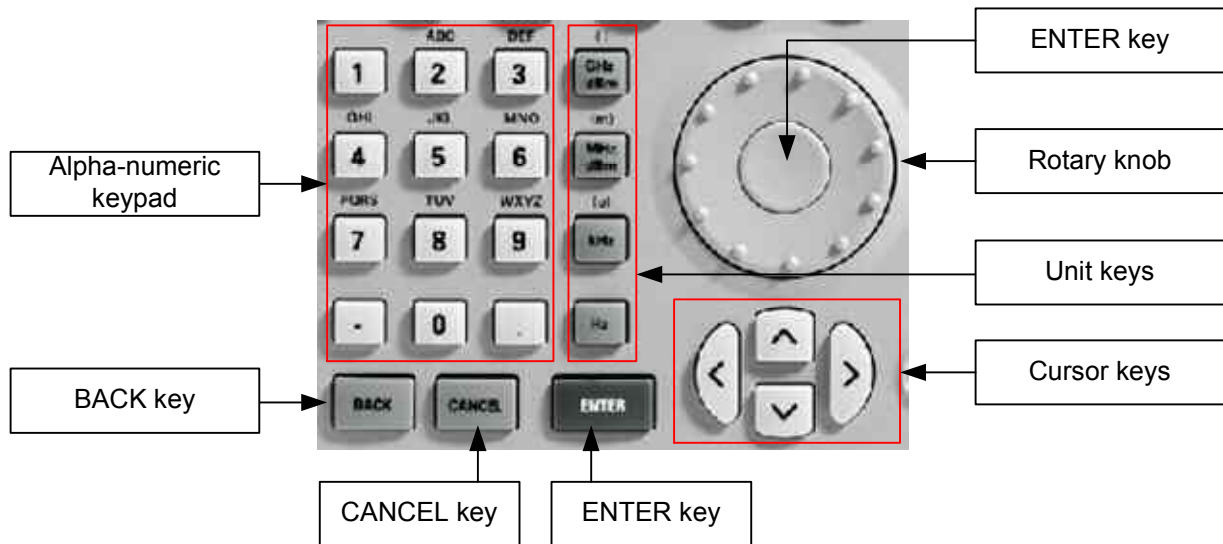

Entering values and texts

Values are entered using the number keys (0 to 9), the decimal point key (.) and the minus key (-) in the alphanumeric keypad. The alphanumeric keypad is also used to enter letters, e.g. file names for data sets. If the R&S FSH is expecting a letter entry, it automatically assigns the letters above the keys to the keys in the alphanumeric keypad. The keys have multiple assignments. The letter you want is obtained by pressing the key the appropriate number of times. The key assignments are listed below:

Key	1.	2.	3.	4.	5.	6.	7.	8.	9.
1	1								
2	a	b	c	2	A	B	C		
3	d	e	f	3	D	E	F		
4	g	h	i	4	G	H	I		
5	j	k	l	5	J	K	L		
6	m	n	o	6	M	N	O		
7	p	q	r	s	7	P	Q	R	S
8	t	u	v	8	T	U	V		
9	w	x	y	z	9	W	X	Y	Z
-	-								
0	0	leer	_						
.	.								

You can delete any letter or digit you have entered with the BACK key. Pressing the BACK key deletes the last keystroke that has been entered. Complete entries can be cancelled with the CANCEL key.

Values can also be entered with the rotary knob or the cursor keys. The entry is changed in steps and the R&S FSH immediately sets the appropriate entry parameter.

Entering units

To enter a unit for a value entry, terminate the entry with a unit key. Use the unit keys down the right-hand side of the alphanumeric keypad. These keys have multiple assignments which depend on the unit entry expected by the R&S FSH.



GHz, -dBm, V, s



MHz, dBm, dBmV, mV, ms



kHz, dB μ V, μ V, μ s



kHz

The relative unit dB can be entered with any of the unit keys.

Menu Overview

Softkeys available for all measurement modes

User settings

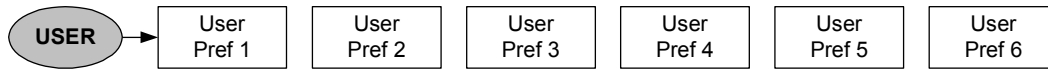

File management

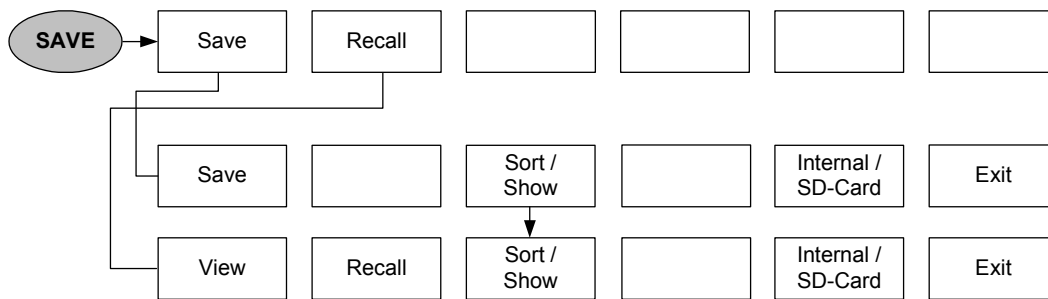

Tables

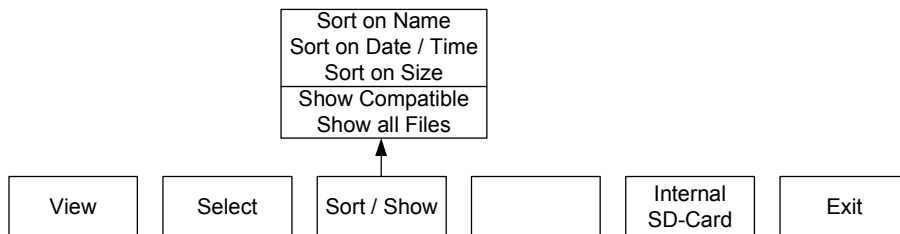

General settings

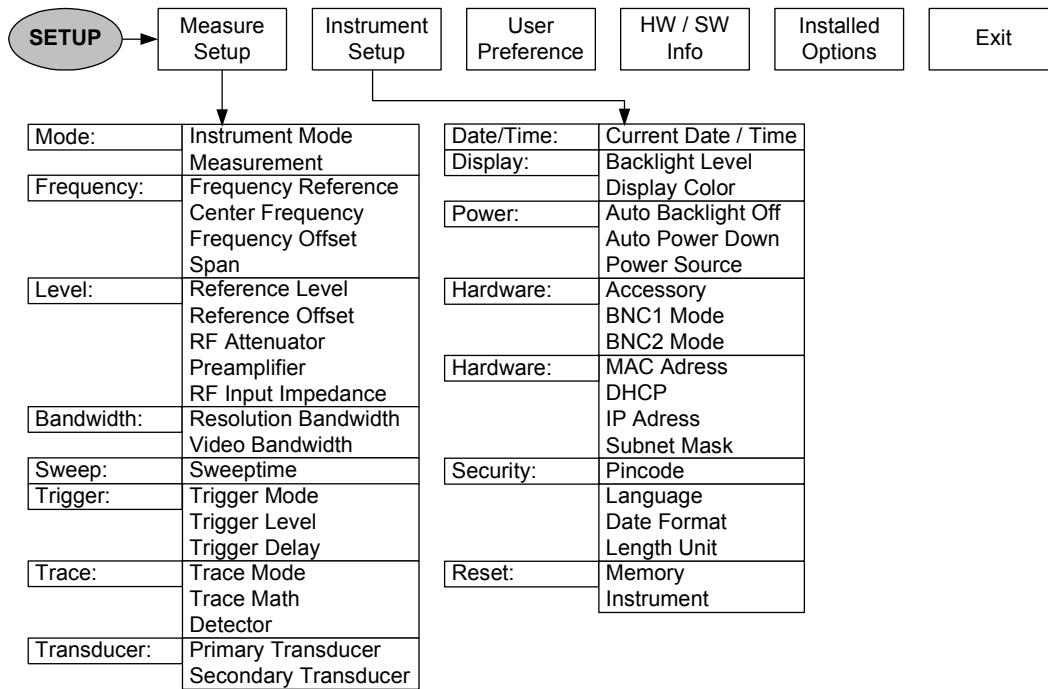

Selection of the measurement mode



Softkeys of the spectrum analyzer mode

Frequency entry

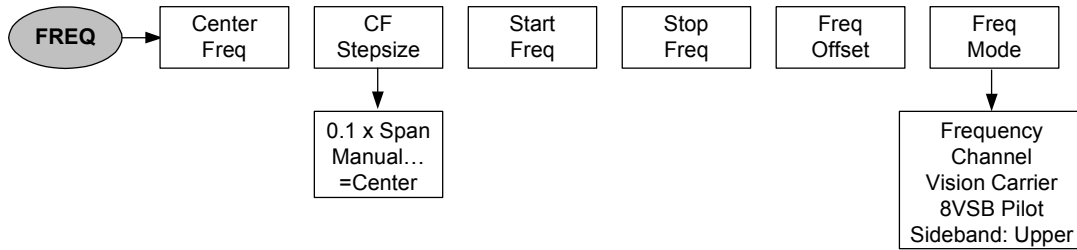

Frequency span

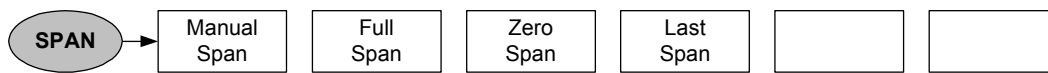

Level settings

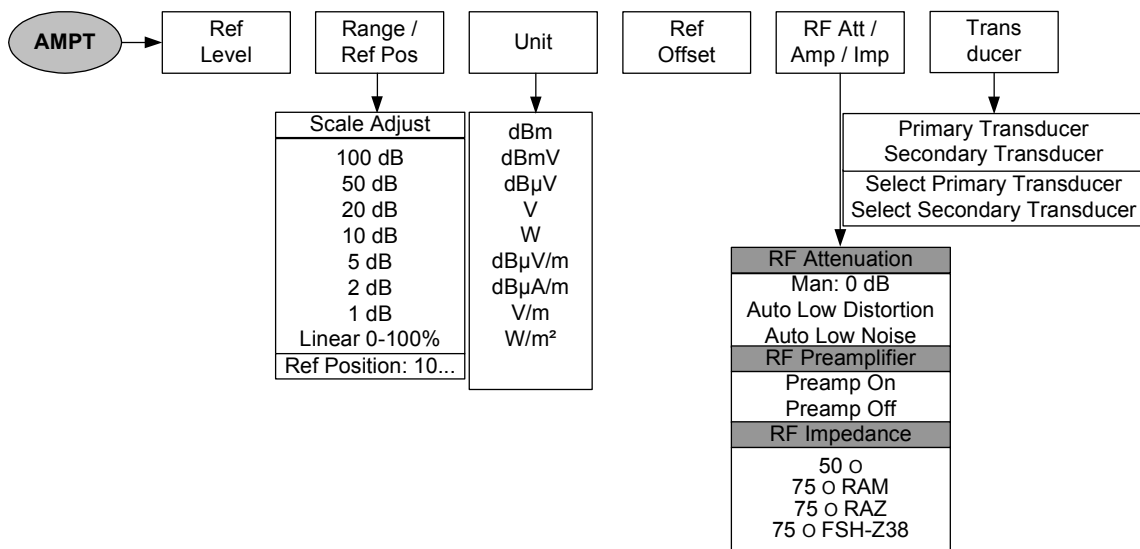

Bandwidth settings

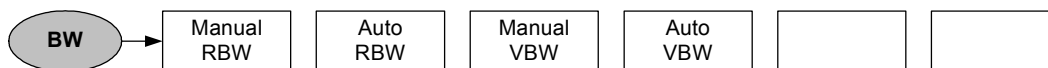

Sweep

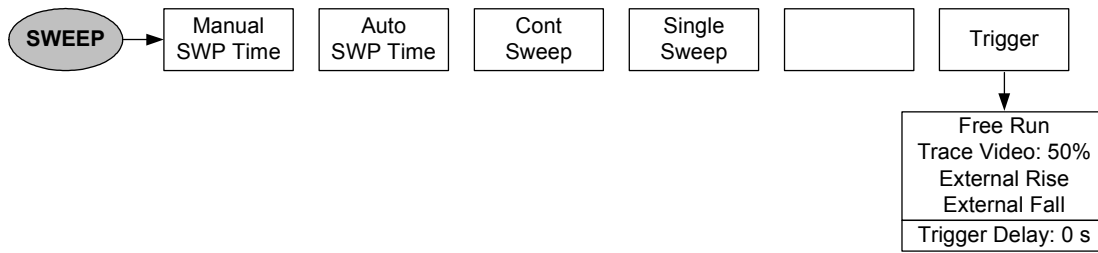

Trace settings

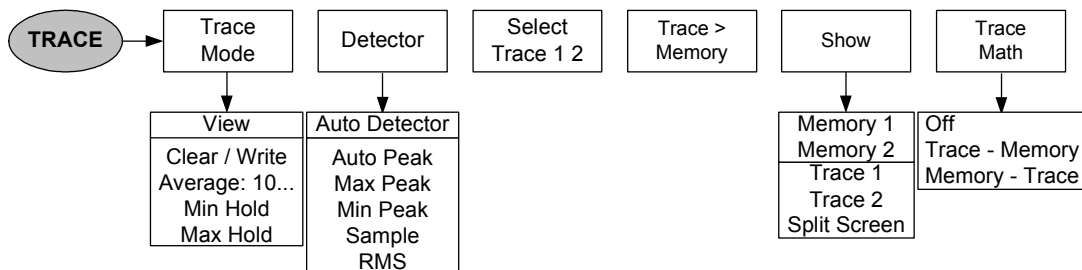

Limit lines

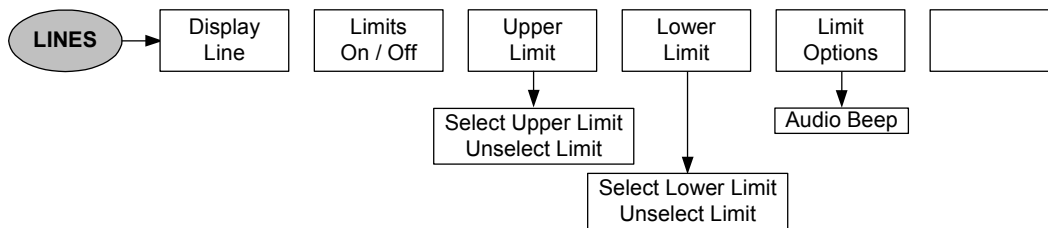

Measurement functions

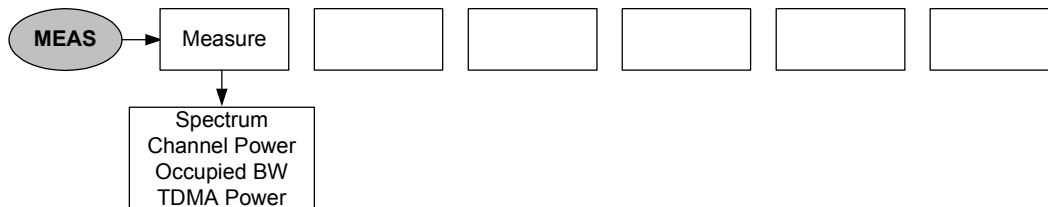

Channel power

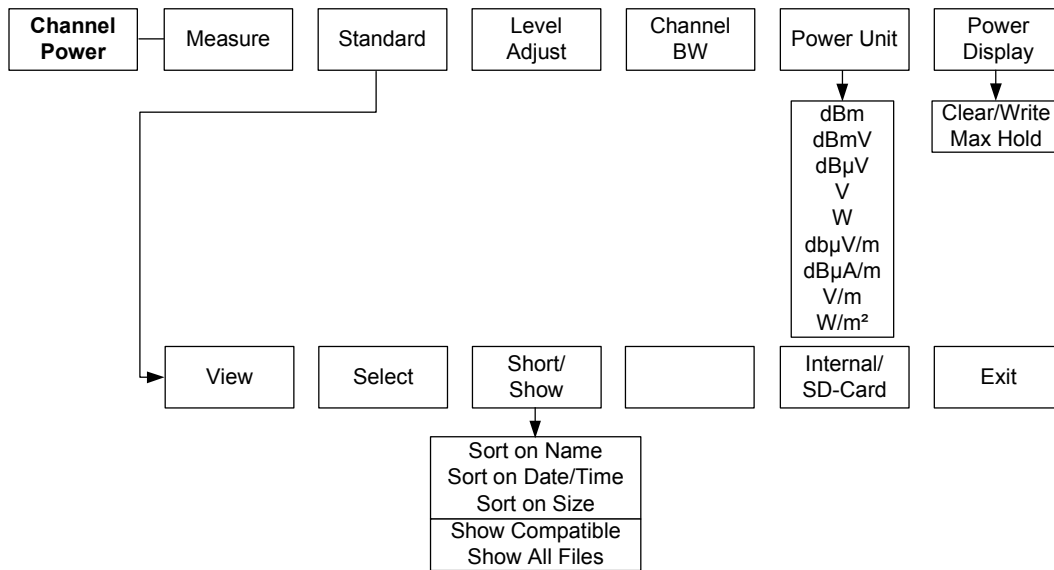

Occupied Bandwidth

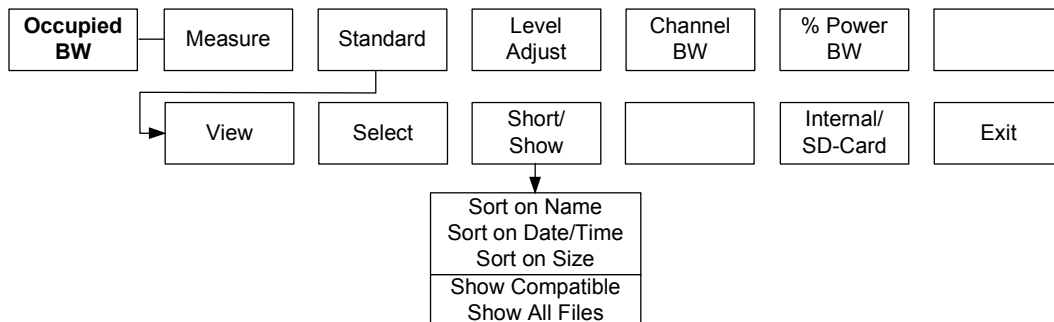

TDMA Power

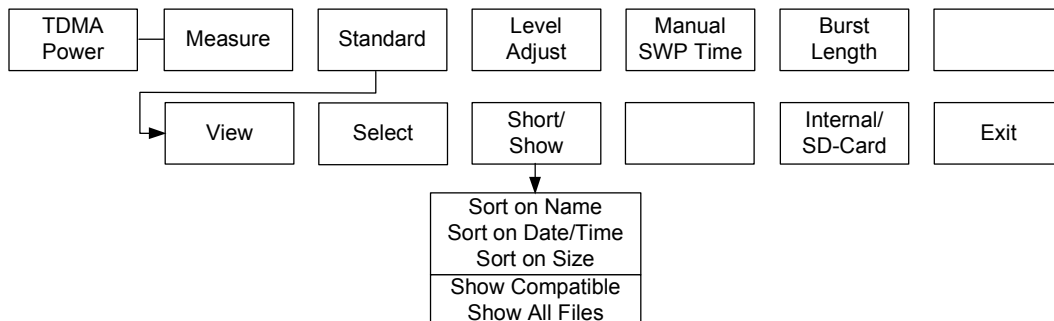

Marker

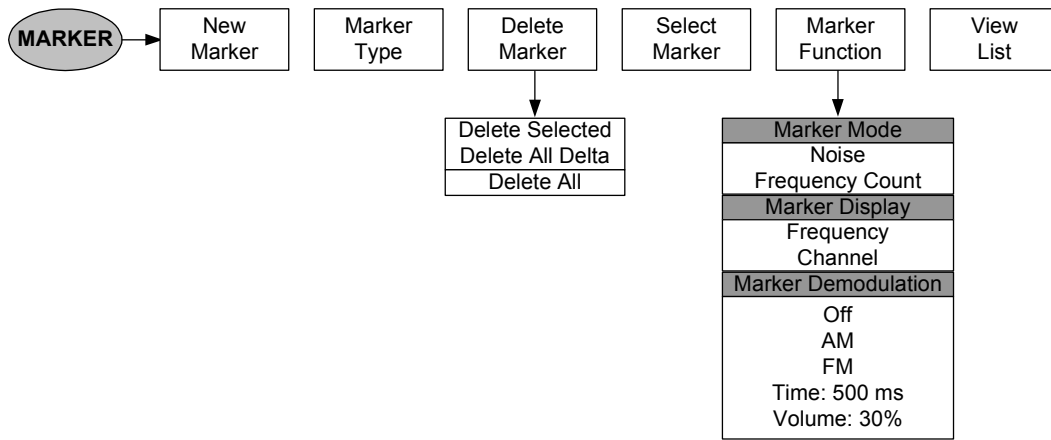

Marker position

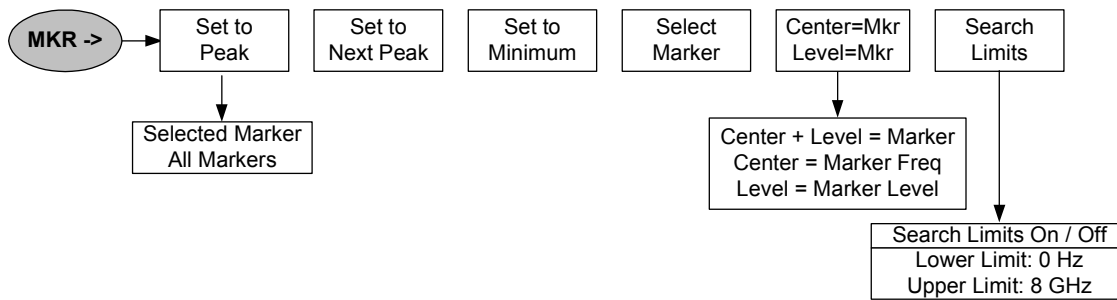

Softkeys of the network analyzer mode

Frequency entry

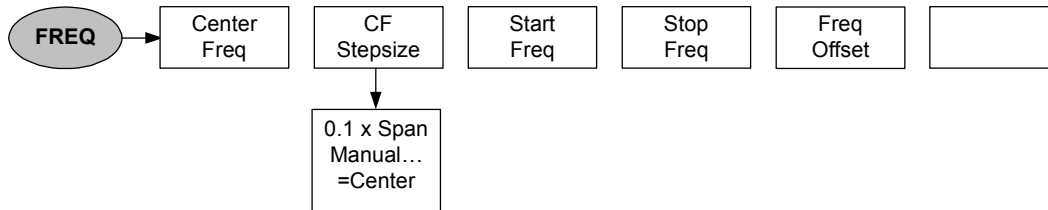

Frequency span

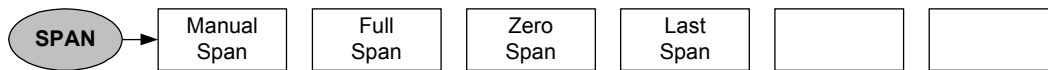

Level settings

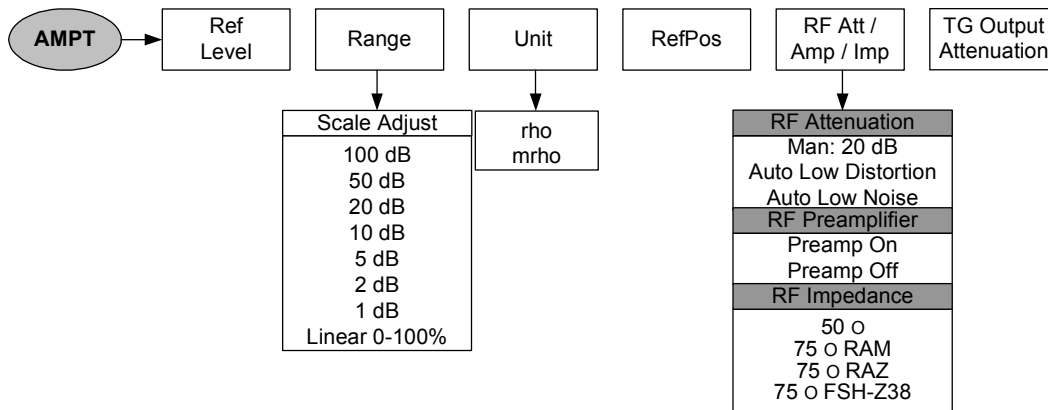

Bandwidth settings

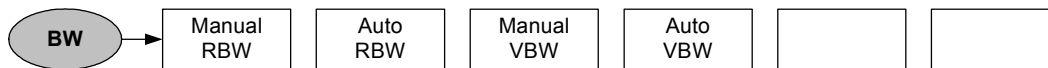

Sweep

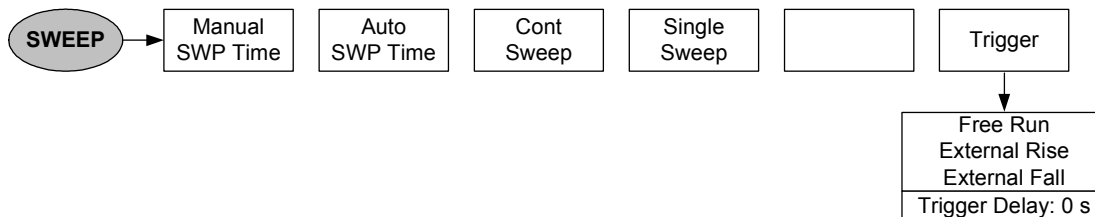

Trace settings

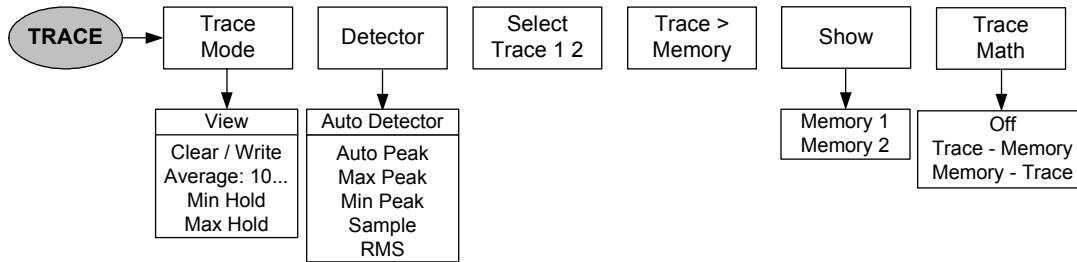

Limit lines

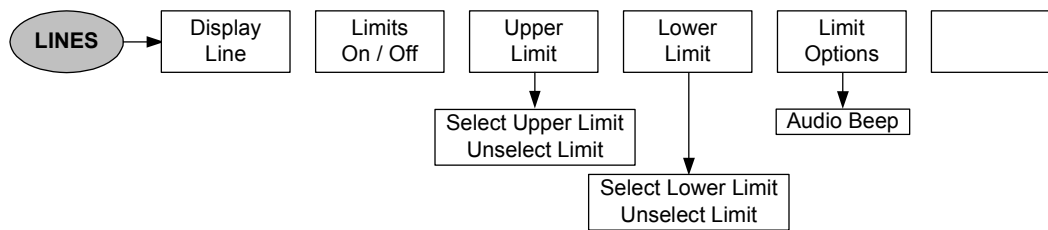

Measurement functions

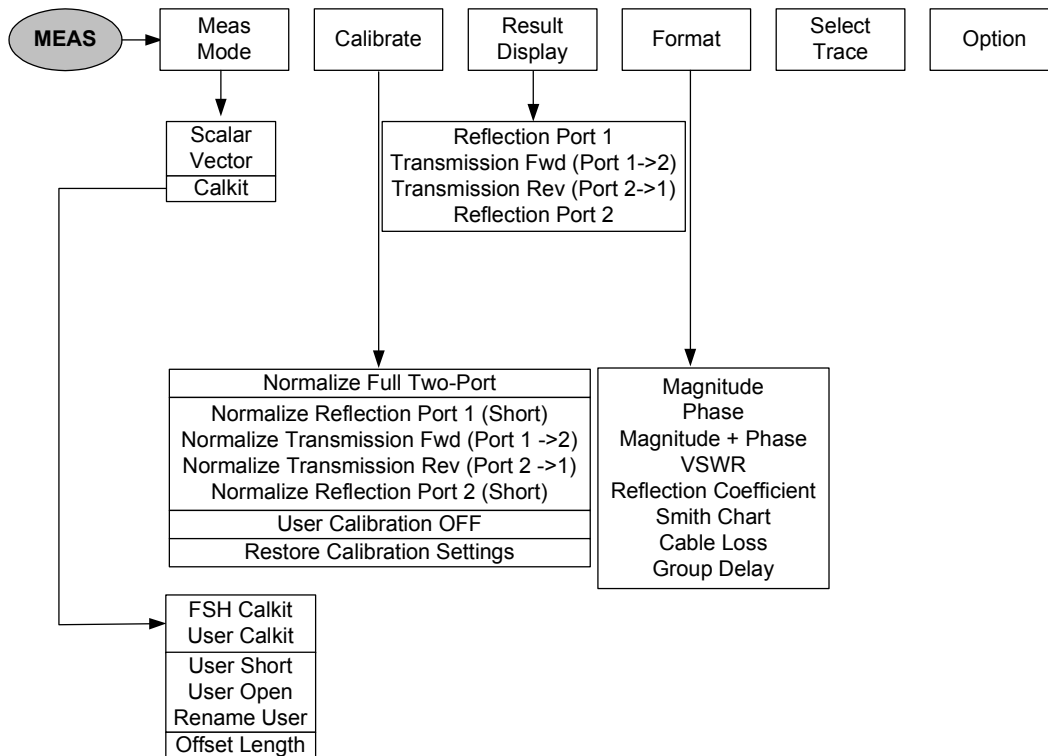

Marker

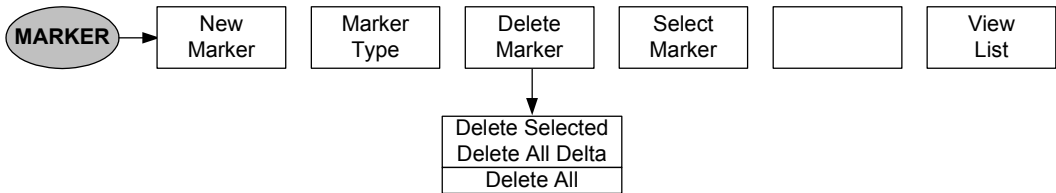

Marker position

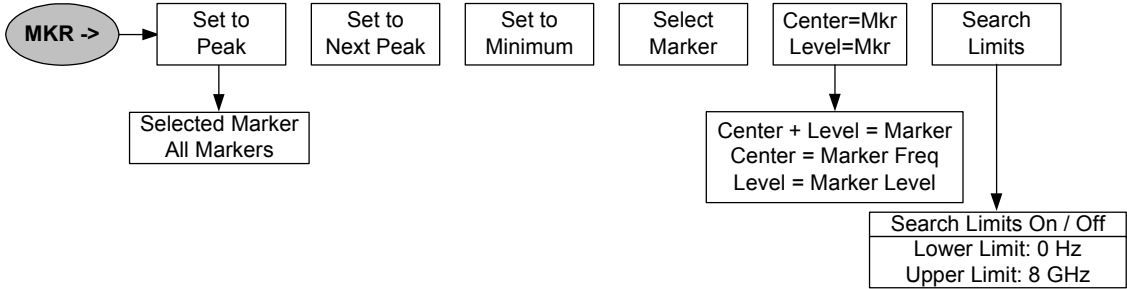

Softkeys of the Distance to Fault mode

Frequency entry

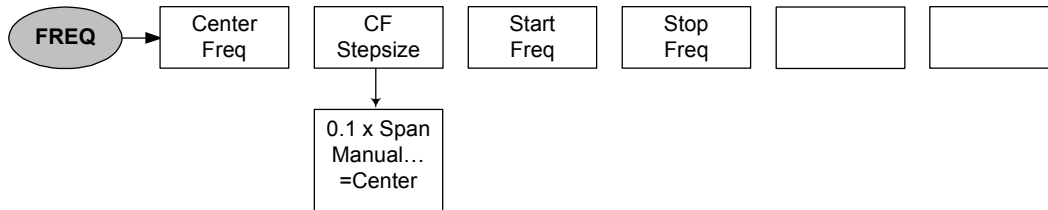

Frequency span

DTF Span



Reflection and Spectrum Span

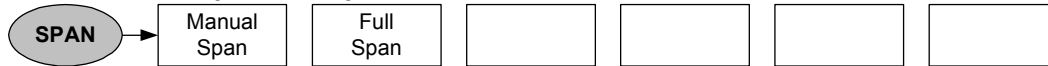

Level settings

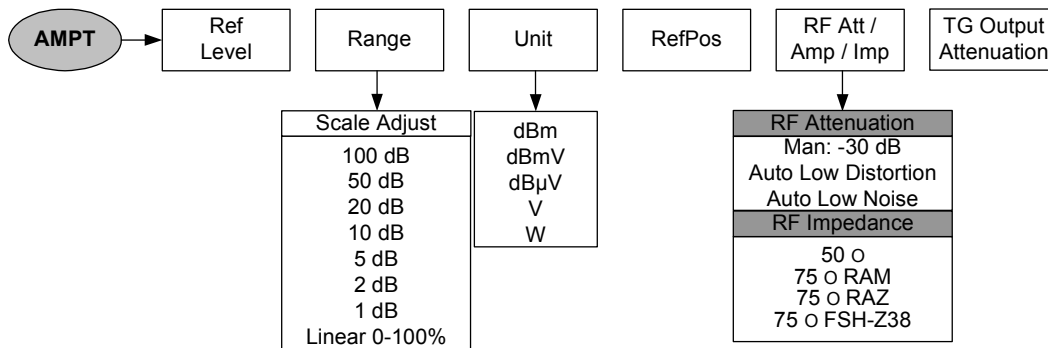

Bandwidth settings



Sweep

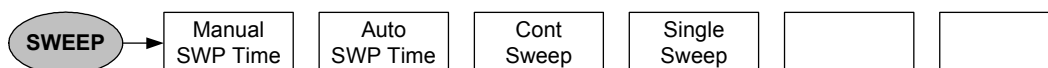

Trace settings

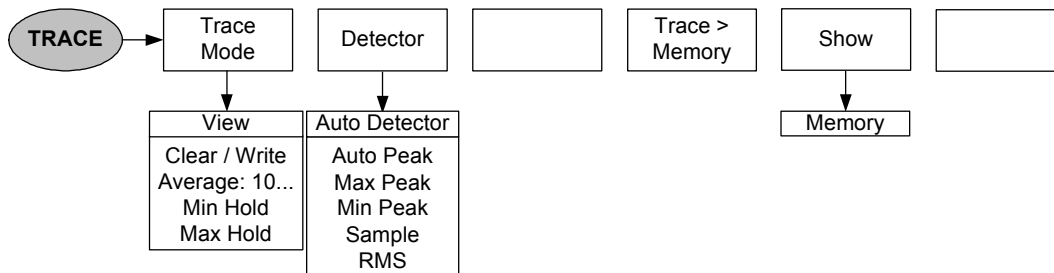

Measurement functions

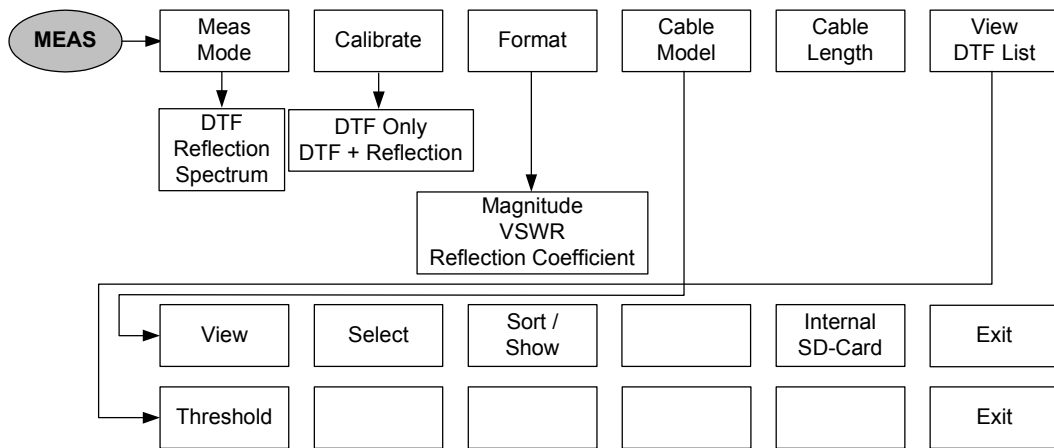

Marker

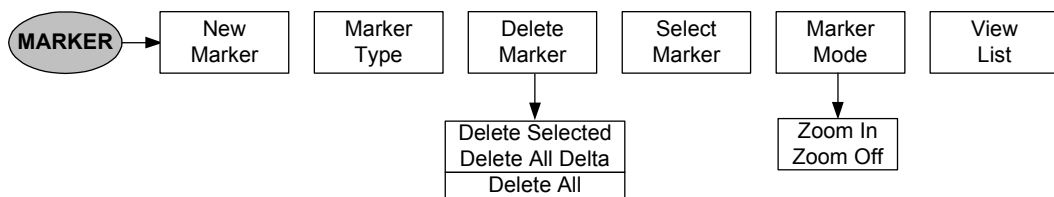

Marker position

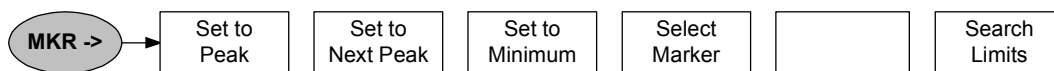

Softkeys of the Power Meter mode

Frequency entry

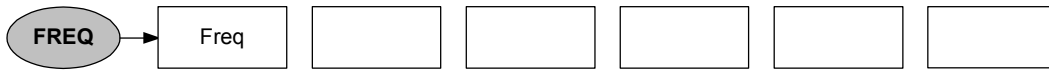

Level settings

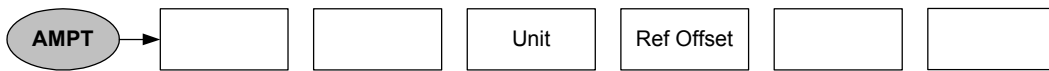

Sweep



Measurement functions

Power Meter Mode:

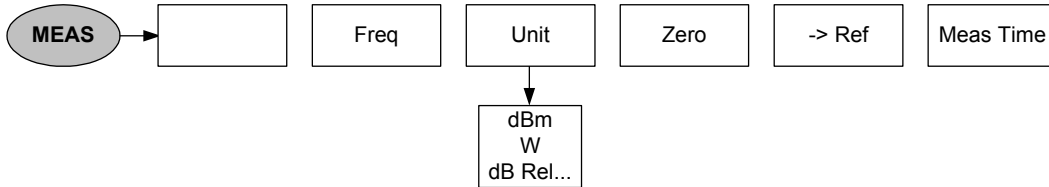

Directional Power Meter Mode:

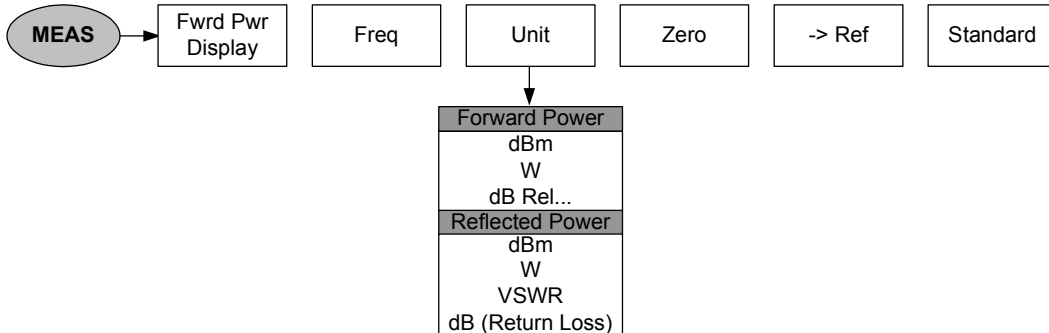

4 Instrument Functions

Instrument Default Setup

When you press the PRESET key, the R&S FSH is set to its default setup or presets. It is best to select the PRESET when you are going to perform a new measurement task. The new settings can then be made on the basis of the more familiar default setup without the old settings affecting the measurement.

Operating sequence:

- Press the PRESET key (green key below and to the right of the rotary knob).

The R&S FSH is immediately set to the default setup.

Setting the Frequency

The R&S FSH's frequency is set with the FREQ key. The frequency can be specified in terms of the center frequency (center freq. = frequency at the center of the frequency axis in the measurement diagram) or the start and stop frequency for a particular span.

It is best to enter the center frequency when a signal is to be measured at a known frequency. When you are investigating signals, e.g. harmonics, that are within a particular frequency range, the best option is entering a start and stop frequency to define the span.

Entering the center frequency

- Press the **FREQ** key.

The R&S FSH opens the frequency menu. Center frequency entry is always activated, so that the frequency settings can be made with the minimum number of keystrokes. The current center frequency is displayed in the value entry box. A new center frequency can be entered directly from the numeric keypad. You can also use the rotary knob or the cursor keys.

- Enter the frequency you want from the numeric keypad and terminate the frequency entry with the appropriate unit (GHz, MHz, kHz or Hz).

The frequency you have entered now becomes the new center frequency. The value entry box remains open for any further entries.

- As an alternative, you can change the center frequency with the rotary knob or the cursor keys and terminate the entry with the **ENTER** key.
- You can clear the value entry box from the screen by pressing the **CANCEL** key.

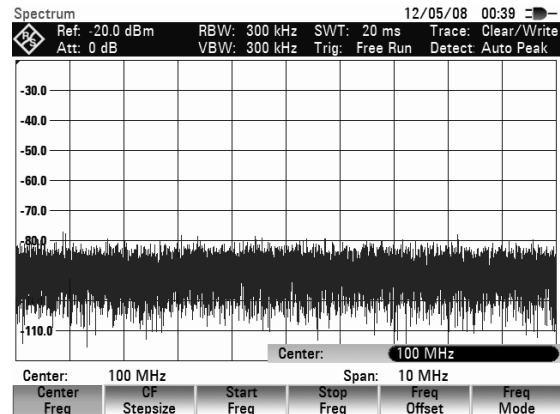

The smallest step for adjusting the center frequency with the rotary knob is a pixel, in other words, as the trace comprises about 631 pixels, each step is equal to about 1/630 of the span. When you use the cursor keys, a frequency step is equal to 10 % of the span (= 1 grid division). If you want to use a different step size, you can define it with the **CF STEPSIZE** function (CF = center frequency).

When you are adjusting the center frequency, you may obtain a value that is outside the R&S FSH's maximum span. If this happens, the R&S FSH automatically reduces the span.

Setting a frequency offset

For measurements on frequency converters such as satellite downconverters, it is often convenient to reference the results to the frequency prior to conversion. For this purpose, the R&S FSH offers a frequency offset, which arithmetically shifts the center frequency to higher or lower frequencies; thus, the R&S FSH displays the input frequency of the DUT.

Positive frequency offset is possible in the 1 Hz to 100 GHz range, in 1 Hz steps. The size of the negative frequency offset permitted depends on the start frequency setting; the start frequency, taking into account the frequency offset, is always ≥ 0 Hz.

- Press the **FREQ** key.
- Press the **FREQ OFFSET** softkey.

The R&S FSH opens the frequency offset entry field.

- Enter the required frequency offset and terminate with the corresponding unit.

The R&S FSH adds the frequency offset to the set center frequency. The center frequency display is marked by a red dot to indicate that a frequency offset has been set.

The frequency offset can be reversed if an offset of 0 Hz is entered.

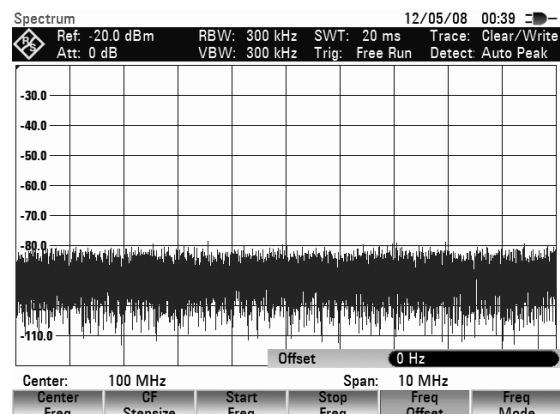

Entering the center-frequency step size

- Press the CF STEPSIZE key.

A submenu above the softkey label opens. The box contains various step size setting options.

With 0.1 x SPAN (default setting), the step size is equal to 10 % of the span (= 1 division on the vertical scale).

With = CENTER, the step size is equal to center frequency. This setting is ideal for measurements on harmonics. On each frequency increment, the center frequency moves to the next harmonic.

With MANUAL... you can select any step size. This makes it easy to investigate spectra with frequencies at constant intervals.

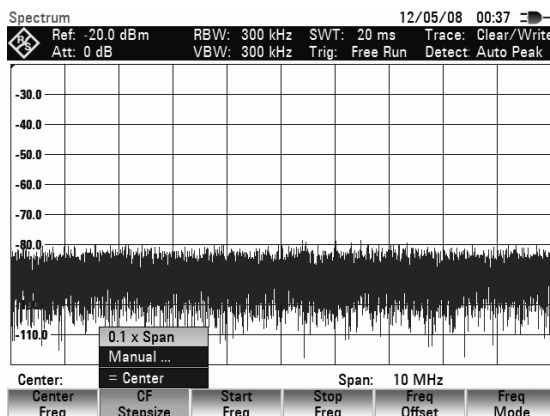

- Make the selection you want with the rotary knob or the cursor keys and terminate with the ENTER key.

If you select "0.1 x SPAN" or "= CENTER", the R&S FSH makes the setting directly itself. If you select "MANUAL...", the value entry box opens and indicates the current step size.

- Using the rotary knob, the cursor keys or numeric entry, change the step size.
- When you have entered the step size you want, confirm by pressing the ENTER key or by pressing the CF STEPSIZE softkey.

Entering the start and stop frequency

- Press the START FREQ softkey.

The value entry box for the start frequency opens. The box displays the current frequency.

- Enter a new start frequency with the number keys and terminate the entry with one of the unit keys or
- Adjust the start frequency with the rotary knob or the cursor keys and terminate the entry with the ENTER key.

The R&S FSH sets the new start frequency. The x axis labelling changes from CENTER and SPAN to START and STOP.

- Press the STOP FREQ softkey.

The R&S FSH opens the value entry box for the stop frequency. The box indicates the current frequency.

- Enter a new stop frequency using the number keys and terminate the entry with one of the unit keys, or
- Adjust the stop frequency with the rotary knob or the cursor keys and terminate the entry with the ENTER key.

The new stop frequency is now set on the R&S FSH.

If you enter a stop frequency on the R&S FSH which exceeds the maximum stop frequency of the instrument model, the R&S FSH will set the stop frequency to the maximum permissible stop frequency. If you reach this frequency limit with the rotary knob or the cursor keys, the R&S FSH will ignore any further rotary ticks or cursor steps.

Working with channel tables

Almost all transmission systems divide their assigned frequency ranges into channels, with a specific frequency assigned to each channel. The R&S FSH therefore allows users to define channel assignments using familiar terms to keep operation simple.

Channel tables are defined with the R&S FSH4View software and loaded into the spectrum analyzer. The R&S FSH can store more than 100 different channel tables which can be activated from the front panel as required. The maximum number of channel tables may be reduced if transducer factors, cable models, limit values or data sets are stored simultaneously (see "Saving and Loading Instrument Settings and Measurement Results" in this chapter)

The R&S FSH4View software operating manual describes how to generate channel tables.

Switching to channel entry:

- Press the **FREQ** key.
- Press the **FREQ MODE** softkey.
- Select **CHANNEL** from the menu with the rotary knob or the cursor keys and confirm with the **ENTER** key.

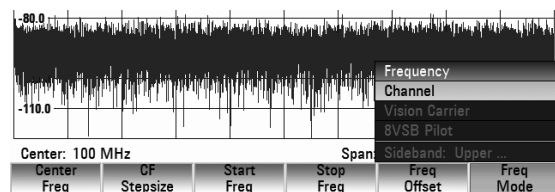

The R&S FSH opens the list of channel tables loaded via R&S FSH4View.

- Select the desired channel table with the rotary knob or the cursor keys and switch it on with the **SELECT** softkey.

If necessary the table entries can be sorted using softkey **SORT/SHOW** according to their names/date/size. In addition table entries, which are incompatible with the current instrument settings, can be blanked out.



The channel number together with the name of the selected channel (e.g. GSM UL Ch: 1) is now displayed instead of the center frequency. The **FREQUENCY** softkey is now called **CHANNEL**.

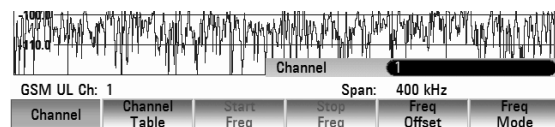

The R&S FSH center frequency is the frequency corresponding to the displayed channel number from the channel table. The R&S FSH accepts only channel numbers when entering the center frequency. Tuning the frequency with the rotary knob or the cursor keys is also done using channel numbers. All other measurement parameters such as **SPAN** or **RBW** (resolution bandwidth) are user-selectable as with the entry of frequencies.

The entries for the start frequency (**START FREQ**) and the stop frequency (**STOP FREQ**) are inactive when defining channels.

Channel numbers are assigned to frequencies as follows:

- The first channel is assigned a channel number and a frequency.
- All subsequent channels have ascending numbers.
- The frequency spacing between channels is fixed. It can also be negative, i.e. the center frequency of the R&S FSH decreases with ascending channel number.
- In transmission systems containing gaps in the frequency range (as in the case of television, for example), a channel table can comprise multiple ranges.

Setting the Span

The span is the frequency range centered on the center frequency which a spectrum analyzer displays on the screen. What span should be selected for a particular measurement depends on the signal to be investigated. A rule of thumb is that it should be at least twice the bandwidth occupied by the signal.

For frequency domain measurement the R&S FSH4 has a minimum span of 100 Hz and a maximum span of 3.6 GHz. Using the span 0 Hz measurement is performed in time domain. The maximum span is 8 GHz with the R&S FSH8.

Operating sequence:

- Press the SPAN key.

When the SPAN key is pressed, the R&S FSH automatically activates the MANUAL SPAN softkey and indicates the current value so that a new span can be entered immediately. If another function in the SPAN menu has been used beforehand, press the MANUAL SPAN softkey to enter the span.

- Enter a new span with the number keys and terminate the entry with the appropriate unit (GHz, MHz, kHz or Hz), or
- Change the span with the rotary knob or the cursor keys. The span is set immediately after the change is made.
- The value entry box can be cleared from the screen with the CANCEL key.

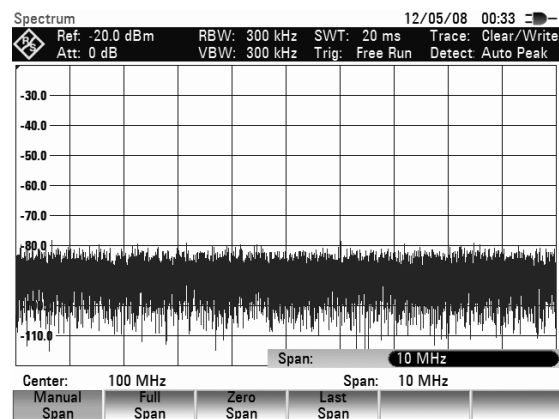

Use the FULL SPAN softkey to select the maximum span with a single keystroke.

- Press the FULL SPAN key.

The R&S FSH displays the spectrum over the full span which extends to 3.6 GHz or to 8 GHz. (CENTER = 1.8 GHz, SPAN = 3.6 GHz, CENTER = 4 GHz, SPAN = 8 GHz).

The R&S FSH has a LAST SPAN softkey so that you can toggle between span settings with just one keystroke.

- Press the LAST SPAN key.

The span that was set immediately before the current span is restored.

The ZERO SPAN softkey sets the span to 0 Hz. The R&S FSH measures the signal level only at the center frequency that has been set. As a spectrum cannot be displayed when measurements are made at a single frequency, the display mode switches to the time domain. The x axis of the measurement diagram becomes the time axis and level is plotted against time. The display always starts at 0 s and stops after the sweep time that has been set (set with the SWEEP key, see also "Setting the Sweep").

Setting the Amplitude Parameters

All R&S FSH settings referred to the level display are made with the AMPT key.

The reference level (REF) is the level represented by the uppermost grid line in the measurement diagram. The input signal gain up to the display stage is set with the reference level. If the reference level is low, the gain is high, which means that even weak signals are clearly displayed. If the input signals are strong, a high reference level must be set to prevent the analyzer signal path from being overdriven and to keep the signal display within the display range. When displaying the spectrum of a composite signal, the reference level should be at least high enough to ensure that all the signals are within the measurement diagram.

The RF attenuation setting at the input of the R&S FSH is directly coupled to the reference level. If the reference level is high, RF attenuation is switched on in steps of 10 dB according to the following table so that the input mixer always remains in the linear range.

The R&S FSH has two different modes for the attenuation setting. The modes are selected using the RF ATT / AMP / IMP softkey. In Auto Low Distortion mode, the R&S FSH sets the RF attenuation 10 dB higher in line with the table, making the stress of the input mixer 10 dB less at the specified reference level. If the spectrum is densely occupied with signals, as occurs in a television cable network, the input mixer reduces the R&S FSH's inherent spurious products. However, the inherent noise display of the R&S FSH increases due to the increased attenuation in front of the input mixer.

In Auto Low Noise mode, the R&S FSH sets the RF attenuation 10 dB lower. This increases the sensitivity of the R&S FSH, which means that the inherent noise display decreases due to the lower attenuation in front of the input mixer.

Reference Level	Preamplifier OFF		Preamplifier ON	
	RF attenuation		RF attenuation	
	Low Noise	Low Distortion	Low Noise	Low Distortion
≤ -30 dBm	0 dB	0 dB	0 dB	0 dB
-29 bis -25 dBm	0 dB	0 dB	0 dB	5 dB
-24 bis -20 dBm	0 dB	0 dB	0 dB	10 dB
-19 bis -15 dBm	0 dB	5 dB	5 dB	15 dB
-14 bis -10 dBm	0 dB	10 dB	10 dB	20 dB
-9 bis -5 dBm	5 dB	15 dB	15 dB	25 dB
-4 bis 0 dBm	10 dB	20 dB	20 dB	30 dB
1 bis 5 dBm	15 dB	25 dB	25 dB	35 dB
6 bis 10 dBm	20 dB	30 dB	30 dB	40 dB
11 bis 15 dBm	25 dB	35 dB	35 dB	40 dB
16 bis 20 dBm	30 dB	40 dB	40 dB	40 dB
21 bis 25 dBm	35 dB	40 dB	40 dB	40 dB
26 bis 30 dBm	40 dB	40 dB	40 dB	40 dB

The status of the RF attenuation and the preamplifier can be queried in the Status menu (press the STATUS key).

The reference level is in dBm for the default setting. However, the units dBmV, dB μ V, Watt and Volt can also be selected. Unit selection is of most relevance to the marker level display as the marker level is displayed in the unit of the reference level.

A reference offset (REF OFFSET) can be defined for the reference level. The reference offset is a way of increasing the reference level by a certain amount. This is useful if, for example, an attenuator or amplifier has been inserted before the RF input. The R&S FSH automatically takes the loss or gain into account when the level is displayed and no manual calculations are necessary. A loss introduced at the RF input must be entered as a positive number and a gain as a negative number.

The measurement range (RANGE) determines the resolution along the level axis in the measurement diagram. When the PRESET or default setting has been selected, the level axis is scaled in dB. The measurement range is 100 dB or 10 dB per division (10 dB/DIV). The R&S FSH also provides the level ranges 50 dB (5 dB/DIV), 20 dB (2 dB/DIV), 10 dB (1 dB/DIV) and 1 dB (0.1 dB/DIV), which enhance the resolution along the level axis. However, increasing resolution does not increase the accuracy of, for example, the marker level readout, but only makes it easier to read values off the trace. You can also select a linear level scale with LIN 0-100 %. The level is expressed as a percentage (0 % to 100 %) of the reference level. This mode is useful if you want to display, for example, a carrier being amplitude modulated in the time domain (SPAN = 0 Hz).

The R&S FSH can also handle measurements on 75 Ω systems. The R&S FSH does not select a 75 Ω RF input per se, but instead only a 75 Ω matching pad connected at the RF input. The 50/75 Ω Matching Pad R&S RAZ is recommended for 75 Ω matching (see recommended accessories). The R&S FSH automatically considers the conversion factor when a value of 75 Ω is set. Other matching pads such as the R&S RAM or R&S FSH-Z38 can be taken into account by using a transducer factor (included with the R&S FSH4View control software).

Setting the reference level

- Press the AMPT key.

The reference level entry is activated immediately. The REF LEVEL softkey label is highlighted in red.

- Enter a reference level with the number keys and either terminate the entry with one of the unit keys (-dBm or dBm for relative measurements or (), m, μ , n for absolute measurements) or press the ENTER key, or
- Adjust the reference level with the rotary knob or the cursor keys.

Any changes you make to the reference level with the rotary knob or the cursor keys are immediate. The trace moves as changes to the reference level are made.

- When the reference level you want has been set, you can remove the value entry box from the screen by pressing the CANCEL key.

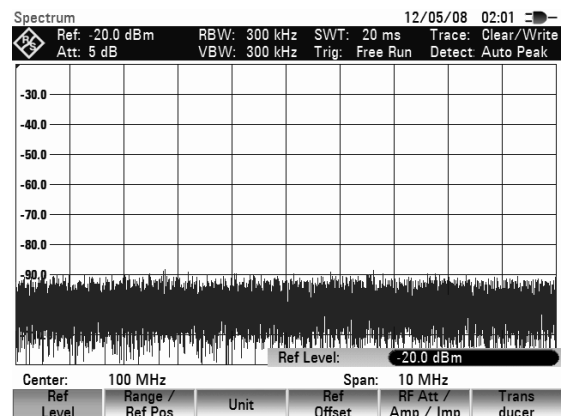

Entering the display range

- Press the AMPT key.
- Press the RANGE/REF POS softkey.

A submenu opens. The various options for scaling the level axis are displayed.

- Using the rotary knob or the cursor keys, select the scaling option you want and confirm by pressing the ENTER key.

The scaling option you have chosen is immediately set on the R&S FSH.

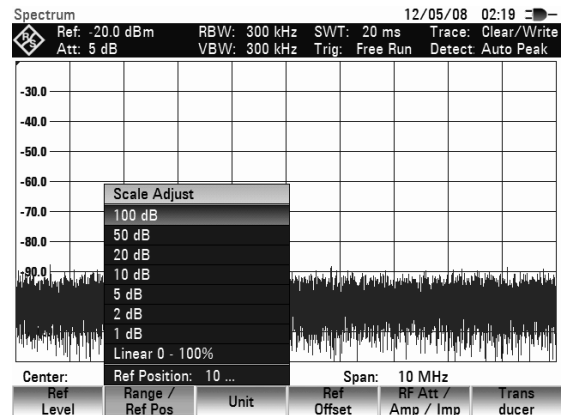

Selecting the menu item REF POSITION: 10 moves the position of the trace to another line on the diagram. This lets you display signals in full which would normally overlap with the top of the diagram.

- Press the RANGE/REF POS .
- Using the rotary knob or the cursor keys, select REF POSITION: 10 and confirm with the ENTER key.
- Using the rotary knob, the cursor keys or the numeric keys, select the desired grid line. The value 10 corresponds with the upper grid line, the value 0 corresponds with the lowest grid line.

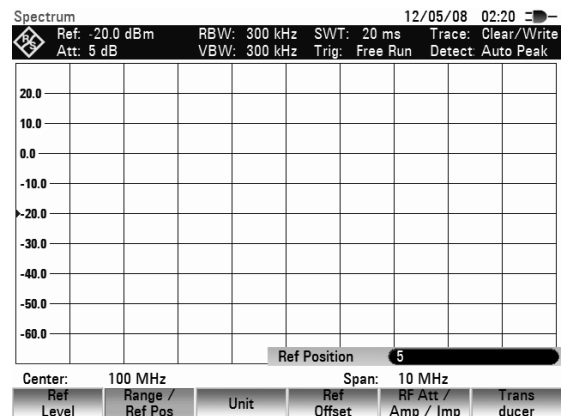

The position of the reference level is marked by a triangle on the selected grid line.

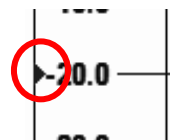

Entering the display unit

- Press the AMPT key.
- Press the UNIT softkey.

A submenu opens. The various unit options for the reference level are displayed.

- Using the rotary knob or the cursor keys, select the unit you want and confirm by pressing the ENTER key.

The reference level unit is immediately set on the R&S FSH.

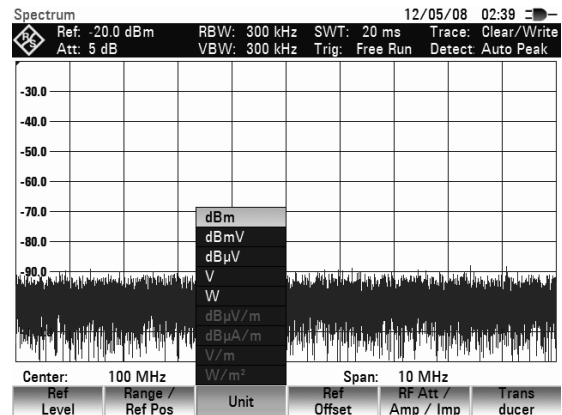

Entering the reference offset

- Press the AMPT key.
- Press the REF OFFSET softkey.
- Using the number keys, enter a reference offset and terminate the entry with one of the unit keys or the ENTER key, or
- Change the reference level using the rotary knob or the cursor keys.

The reference offset unit is always dB – no matter what unit is used for the reference level.

To indicate that a non-zero reference offset has been set, a red circle is placed before the reference level readout.



Entering of the RF-Attenuation

- Press the AMPT key.
- Press the RF ATT / AMP / IMP softkey.

The R&S FSH opens a sub-menu, in which RF ATTENUATION, RF PREAMPLIFIER and RF IMPEDANCE can be selected.

The HF attenuation can be preset at your discretion to between 0 dB and 40 dB in 5 dB steps ("Man:" entry), or set automatically to low sensitivity to interfering signals ("Auto Low Distortion" setting) or to high input sensitivity ("Auto Low Noise" setting).

- Using the rotary knob or the cursor keys, select the desired entry and confirm with the ENTER key.

Note: If the item 'Man:' is selected, a red dot is displayed in front of the RF attenuation output field ('Att.').

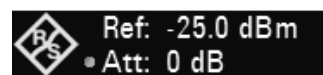
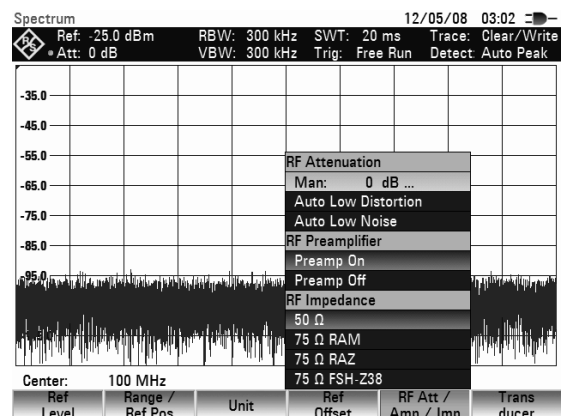

Entering the RF preamplification

To increase the input sensitivity of the R&S FSH, the device has an integrated 20 dB preamplifier upstream of the input mixer. This is switched off in the default state and can be switched on for measuring low power signals.

- Press the AMPT key.
- Press the RF ATT / AMP / IMP softkey.

The R&S FSH opens a sub-menu, to select RF ATTENUATION, RF PREAMPLIFIER and RF IMPEDANCE.

- Using the rotary knob or the cursor keys to select PREAMP ON or PREAMP OFF and confirm with the ENTER key.

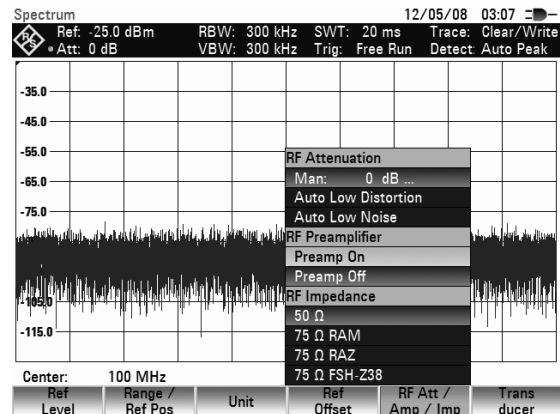

Entering the input impedance

- Press the AMPT key.
- Press the RF ATT / AMP / IMP softkey.

A submenu opens. The two input impedance options “50 Ω” and “75 Ω” are displayed.

- Select the input impedance you want using the rotary knob or the cursor keys and confirm by pressing the ENTER key.

Note: If you have selected 75 Ω, and do not connect a matching pad to the RF input, incorrect level readings will be obtained.

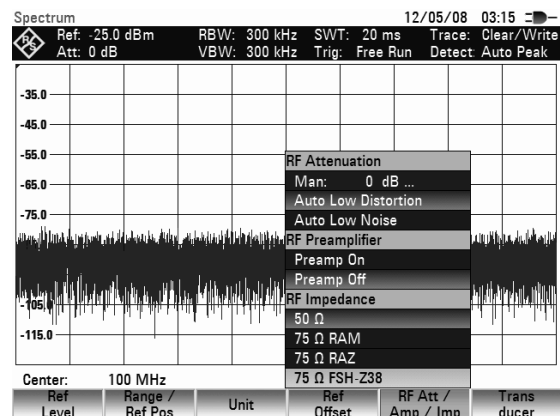

Selecting a transducer factor

In many cases, the R&S FSH is not connected directly with the output of the device under test, but the input signal is fed to the device via a cable, amplifiers or antennas, or a combination of these.

The R&S FSH can account for the frequency shifts of up to 2 connecting components in the measured results. For this purpose, so-called transducer factors have been defined. These can be loaded into the device with the R&S FSH4View software. Each transducer factor consists of a list of frequency/level pairs, which describe the frequency shift of the measuring accessory. For antennas, the unit of the measured electrical or magnetic field strength is included, for isotropic antennas in each case the frequency stage for the x-, y- and z-directions.

You can enable two inputs (Primary/ Secondary Transducer) from the list of transducer factors loaded in the instrument, so that, for example, the device can take a cable and antenna or cable and amplifier combination into account. Note that only one of the two transducers selected can have a unit differing from “dB”.

- Press the AMPT key.
- Press the TRANSDUCER softkey.

The R&S FSH opens a submenu to select the primary and secondary transducer factors.

- Using the rotary knob or the cursor keys, select the menu item SELECT PRIMARY TRANSDUCER and confirm with the ENTER key.

The list of factors available as primary transducer factor opens.

- Using the rotary knob or the cursor keys, select the transducer factor and confirm the selection with the SELECT softkey.

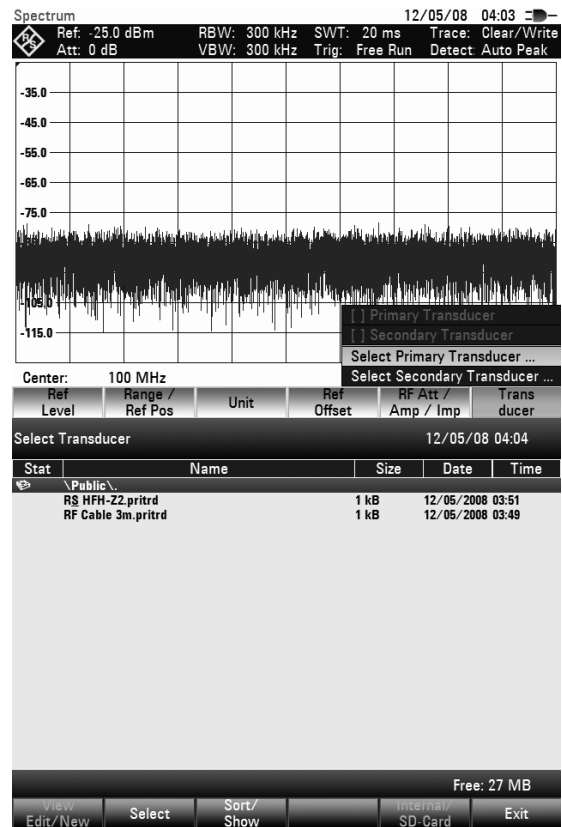

The selected transducer factor will then be displayed in addition the entry field of the reference level.

- To select another transducer factor, use the menu entry SELECT SECONDARY TRANSDUCER and proceed as described above.

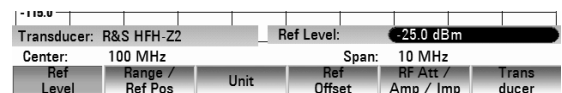

To switch off a selected transducer factor, proceed as follows:

- Press the AMPT key.
- Press the TRANSDUCER softkey.

The R&S FSH opens a sub-menu, in which you can select primary and secondary transducer factors.

- In the submenu select PRIMARY TRANSDUCER or SECONDARY TRANSDUCER with the rotary knob and confirm the selection with the ENTER key.

The transducer factor will then no longer be included in the level display.

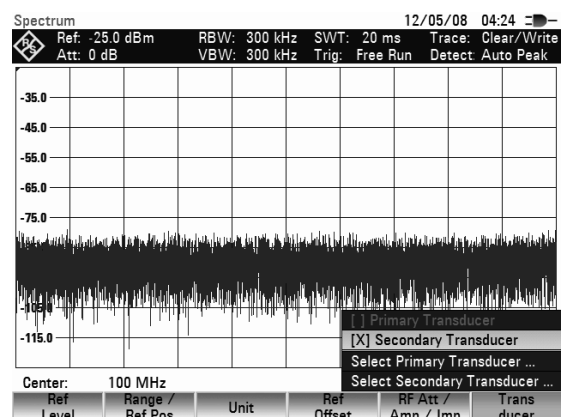

Setting the Bandwidths

A key feature of a spectrum analyzer is that it can display the frequency spectrum of a signal. The resolution bandwidth determines how well a spectrum analyzer can separate adjacent frequencies. Spectrum analyzers usually also have switchable video bandwidths. The video bandwidth is determined by the cutoff frequency of the lowpass used to filter the video voltage before it is displayed. The video voltage is the spectrum analyzer term for the voltage produced when the IF signal which has been band-limited by the resolution filter is envelope detected. The video voltage is smoothed by video filtering to, say, reduce noise on the trace. Unlike the resolution bandwidth, the video bandwidth has no effect on the resolving power of the spectrum analyzer.

Resolution bandwidth

The resolution bandwidth (RES BW) of a spectrum analyzer determines the frequency resolution of spectrum measurements. A sine signal is displayed on the screen "through" the passband of the selected resolution filter. Therefore, a suitably small resolution bandwidth is required if two or more signals whose frequencies are close together are to be displayed separately. The frequency difference between two sinusoidal carriers, for example, cannot be less than the selected resolution bandwidth if the carriers are to be resolved. Which resolution bandwidth is selected also has an effect on the noise displayed by the spectrum analyzer. If the bandwidth is small, the noise displayed drops. If the bandwidth is reduced or increased by a factor of 3, the noise displayed drops or goes up by 5 dB. If the bandwidth is changed by a factor of 10, the displayed noise changes by 10 dB. Which resolution bandwidth is selected also has an effect on the sweep speed. If the true spectrum is to be displayed, the bandfilters that determine the resolution bandwidth must settle at all frequencies of interest. Narrow bandfilters take longer to settle than wide filters. This is why a longer sweep time must be selected for narrow resolution bandwidths. If the bandwidth is reduced by a factor of 3 (e.g. from 10 kHz to 3 kHz), the sweep time must be increased by a factor of 9. If the reduction factor is 10 (e.g. from 10 kHz to 1 kHz) the sweep time must be increased by a factor of 100.

The R&S FSH has resolution bandwidths from 100 Hz to 3 MHz in a 1, 3, 10 sequence. When the default setting is selected, they are coupled to the span, i.e. if the span is reduced, a smaller resolution bandwidth is automatically set. This means that in many cases the resolution bandwidth does not have to be set separately – a higher frequency resolution is automatically set when the span is reduced.

All models offer a 200 kHz resolution bandwidth in addition. This bandwidth has to be selected manually, i.e. it will not be activated automatically in the AUTO RES BW mode (resolution bandwidth coupled to span).

Operating sequence:

- Press the BW key.

The menu for setting the bandwidth opens. If the default setting is activated, the softkey label for automatically setting the bandwidth is highlighted in green.

- Press the MANUAL RES BW softkey

The softkey label is highlighted in red and the value entry box for the resolution bandwidth (RBW) indicates the current bandwidth. To indicate that the resolution bandwidth is not coupled to the span, a small red circle is placed before the resolution bandwidth display on the screen.

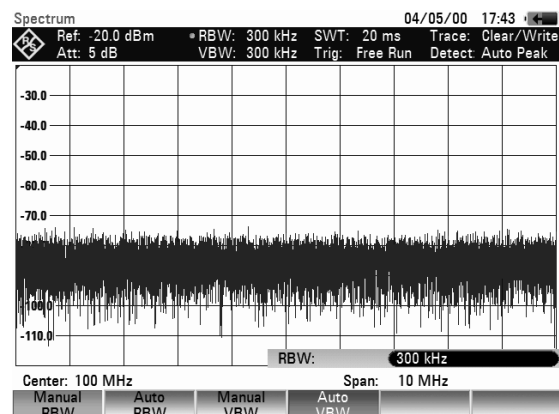

- Enter the resolution bandwidth you want using the number keys and terminate the entry with the appropriate unit (MHz, kHz or Hz), or
- Change the resolution bandwidth to the value you want using the rotary knob or the cursor keys.

Note: The 200 kHz resolution bandwidth has to be entered by means of the number keys. When using the rotary knob or the cursor keys, the 200 kHz bandwidth will be skipped.

The box for entering the resolution bandwidth can be closed by pressing the CANCEL key.

- Press the AUTO RES BW softkey.

The resolution bandwidth is coupled to the span that has been set. The AUTO RES BW softkey label is highlighted in green to show that the coupled mode has been selected. The red circle in front of the RBW readout disappears.

Video bandwidth

The video bandwidth smoothes the trace by reducing noise. When the filtered IF signal is envelope-detected, an IF sine signal becomes a DC voltage in the video signal. If the sine signal is amplitude-modulated, a signal whose frequency is the same as the AM frequency is produced in the video signal apart from the DC voltage from the carrier. The Fig. below shows an RF signal modulated with a sine signal and the corresponding video signal in the time domain.

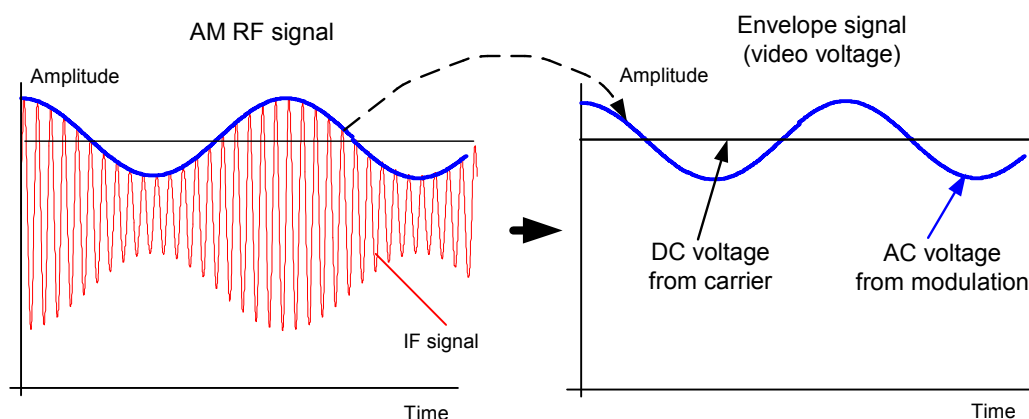

The envelope signal contains a DC component corresponding to the carrier level and an AC component whose frequency is the same as the AM frequency. If the bandwidth of the video filter is less than the frequency of the AC component, the latter will be suppressed depending on its maximum frequency. If the AM component is to be displayed faithfully, the cutoff frequency must be greater than the modulation frequency.

If there is noise on the sine signal, the modulation signal can be thought of as noise. If the video bandwidth is reduced, the high-frequency noise components above the cutoff frequency of the video filter will be rejected. The smaller the video bandwidth, the smaller the noise amplitude at the video filter output.

Therefore, the following rules of thumb can be applied to setting the video bandwidth:

- If you are performing measurements on modulated signals, the video bandwidth must be sufficiently large so that desired modulation components are not rejected (\geq RBW).
- If signals are to be kept free of noise, the smallest video bandwidth possible should be selected ($\leq 0.1 \times$ RBW).
- If measurements are being performed on pulsed signals, the video bandwidth should be at least three times greater than the resolution bandwidth so that the pulse edges are not distorted.

Like the resolution bandwidth, the video bandwidth has an effect on sweep speed. The spectrum analyzer must pause before each measurement to allow the video filter to settle.

The R&S FSH has video bandwidths from 10 Hz to 3 MHz in a 1, 3, 10 sequence. When the default settings are selected, they are coupled to the resolution bandwidth. The video bandwidth equals the resolution bandwidth. When the resolution bandwidth is changed, the R&S FSH automatically sets the appropriate video bandwidth. This means that, in many cases, the video bandwidth does not need to be set separately. When the resolution bandwidth is changed, the video bandwidth is changed automatically.

Operating sequence:

- Press the BW key.

The menu for setting bandwidths opens. When the default setting has been selected, the softkey label for setting the bandwidth automatically is highlighted in green.

- Press the MANUAL VIDEO BW softkey.

The softkey label is highlighted in red and the video bandwidth value entry box (VBW) indicates the current bandwidth. To indicate that the video bandwidth is not coupled to the resolution bandwidth (RBW), a small, red circle is placed in front of the video bandwidth readout on the screen.

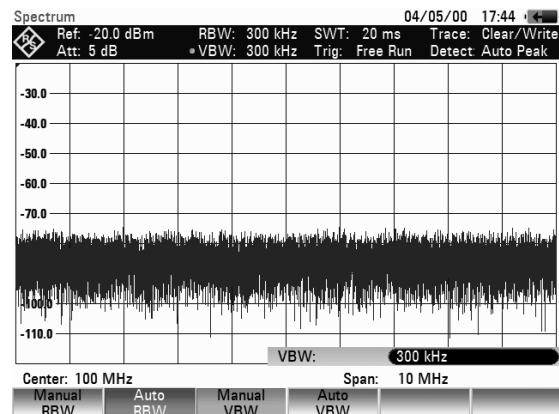

- Enter the video bandwidth you want with the number keys and terminate the entry with the appropriate unit (MHz, kHz or Hz), or
- Change the video bandwidth to the value you want using the rotary knob or the cursor keys.

The video bandwidth value entry box is closed by pressing the ENTER key.

- Press the AUTO VIDEO BW softkey.

The video bandwidth is coupled to the resolution bandwidth that has been set. The AUTO VIDEO BW softkey label is highlighted in green to indicate coupling and the red circle marking the VBW readout disappears.

Setting the Sweep

If the span is > 0 , the sweep time is the time the spectrum analyzer takes to traverse the displayed span to measure the spectrum. Certain boundary conditions must be met if a spurious spectrum is not to be displayed.

One boundary condition is the resolution bandwidth. If the resolution filter is to settle, the dwell time within the filter bandwidth must have the right value. If the sweep time is too short, the resolution filter does not settle and the displayed level is too low (see also "Setting the Bandwidth").

The second boundary condition is the selected span. If the span is increased, the sweep time must be increased proportionally.

The R&S FSH provides automatic sweep time coupling to help users set the sweep time by coupling it to the resolution bandwidth and span that have been set. When automatic coupling (AUTO SWEEP TIME) is selected, it always sets the shortest sweep time possible to ensure that sine signals in the spectrum are displayed correctly. When you quit the auto sweep time mode (MANUAL SWPTIME is activated instead), a small, red circle is placed in front of the SWT readout to indicate that the uncoupled mode has been selected. If the sweep time is so short that level errors occur, the R&S FSH informs the user by displaying a red circle in the measurement diagram.

The R&S FSH requires a minimum sweep time of 20 ms per 600 MHz of span. If a larger span is set, the R&S FSH automatically adapts the minimum sweep time in the coupled mode.

If the span = 0 Hz, the R&S FSH displays video voltage versus time instead of a spectrum. The x axis of the measurement diagram becomes the time axis, starting at 0 s and ending at the sweep time you have selected.

The minimum sweep time when the span = 0 Hz is 200 μ s, the maximum 100 s.

Sweep time

- Press the SWEEP key.

The softkey menu for entering sweep parameters opens. If the default settings have been selected, automatic coupling (AUTO SWPTIME) is set. In this mode, the sweep time is coupled to the resolution bandwidth, the video bandwidth and the span.

- To enter the sweep time, press the MANUAL SWPTIME softkey.

The SWEEP value entry box opens and indicates the current sweep time setting.

- Enter a new sweep time with the number keys and terminate the entry with one of the unit keys, or
- Change the sweep time with the rotary knob or the cursor keys.

Whenever a change is made, the sweep time is immediately set to its new value. The value entry box is closed by pressing the ENTER key. The sweep time that has been set is displayed in the SWT readout box.

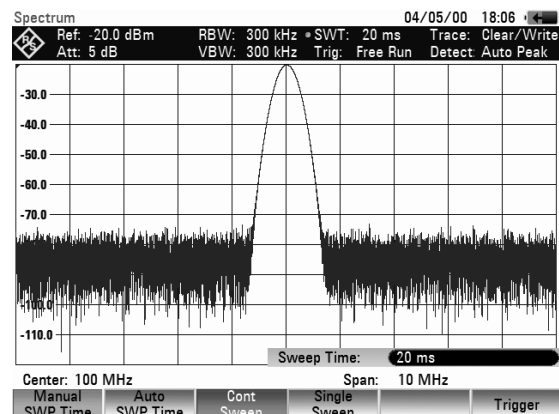

Sweep mode

When the default settings are activated, the R&S FSH is in the continuous sweep mode, i.e. when one sweep of the span has been completed, the sweep is automatically repeated from the start of the span. The trace is refreshed after each sweep.

The continuous mode may not be needed for some applications, e.g. when a single event is to be recorded on certain trigger conditions being met. The R&S FSH, therefore, has a SINGLE SWEEP mode. When the single sweep mode is selected, the R&S FSH sweeps once over the span or displays the time-domain video signal once in the zero-span mode. The measurement will only be repeated if you press the SINGLE SWEEP softkey.

- Press the SWEEP key.

If the default setting is selected, the CONT SWEEP softkey label is highlighted in green to indicate that the continuous sweep mode has been set.

- Press the SINGLE SWEEP softkey.

The SINGLE SWEEP softkey label is highlighted in green. The R&S FSH performs a single sweep and waits for further entries.

- Press the CONT SWEEP softkey.

The R&S FSH now sweeps continuously again.

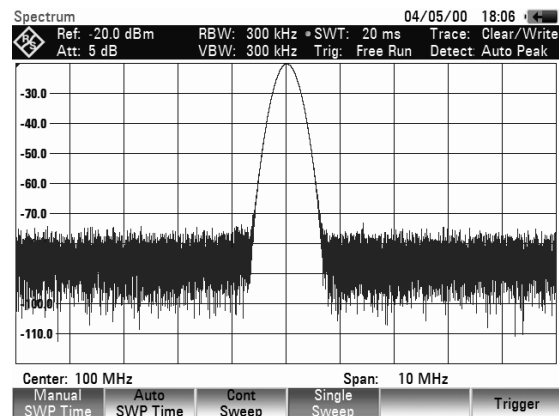

Trigger

To respond to events, the R&S FSH has a variety of trigger functions. The trigger can either be external or generated internally.

- FREE RUN A new sweep starts on completion of the previous sweep. This is the default setting for the R&S FSH.
- VIDEO A sweep starts when the video voltage exceeds a settable value. Video triggering is only available when span = 0 Hz. When a frequency spectrum is being displayed, (span \geq 10 kHz), there is no guarantee that a signal to generate a video voltage is present at the start frequency. Under these circumstances, the R&S FSH would never perform a sweep.
- EXTERNAL RISE and EXTERNAL FALL The sweep is started on the rising edge (RISE) or on the falling edge (FALL) of an external trigger signal. The external trigger signal is fed in via the BNC connector EXT TRIGGER. The switching threshold is 1.4 V, i.e. a TTL signal level.

When a video trigger or an external trigger is selected, the start of measurement can be delayed with respect to the trigger event by entering a delay (DELAY). In this way, time differences between the trigger event and the measurement can be allowed for.

The current trigger setting is displayed centrally at the top of the screen (e.g. Trig: Free Run).

Operating sequence:

- Press the SWEEP key.
- Press the TRIGGER softkey.

The submenu for setting the trigger opens. If the default setting is selected, FREE RUN is highlighted in red. If span = 0 Hz, any setting can be selected; otherwise the settings VIDEO... and DELAY... are in darker labelling to show that they are not available.

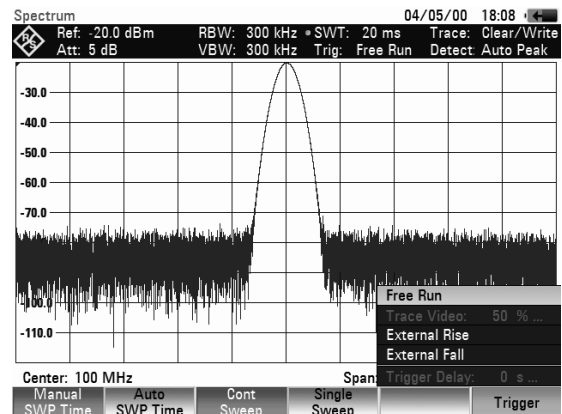

- Select the setting you want with the cursor keys or the rotary knob and terminate the entry with the ENTER key or with the TRIGGER softkey.

The "Trig:" box at the center of the top of the screen indicates the setting that has been selected.

If the VIDEO... trigger setting has been selected, the trigger level and any trigger delay (DELAY...) must be entered. The trigger level is expressed as a percentage (%) of the reference level. 100 % means that the trigger level equals the reference level, 50 % that the trigger level is in the middle of the y axis on the measurement diagram (default setting). The position of the video trigger on the level axis is shown by a ">".

- Change the video-trigger threshold with the cursor keys or the rotary knob (0 to 100 %).

The trigger threshold is set immediately after entry.

- Terminate the trigger threshold entry with the ENTER key or the TRIGGER softkey.

The value entry box is then closed.

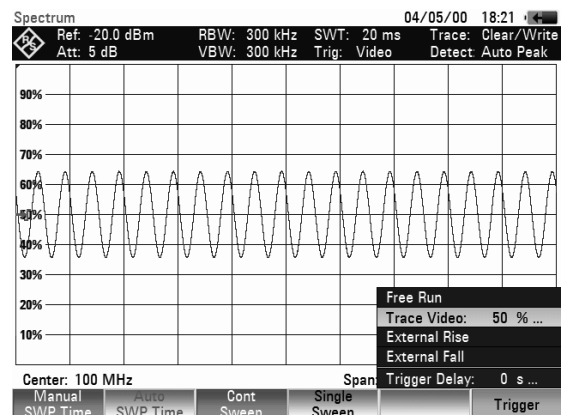

- If a trigger delay is required, press the TRIGGER softkey.
- Using the cursor keys or the rotary knob, select DELAY... and confirm with the ENTER key or the DELAY... softkey.

The delay value entry box is then opened.

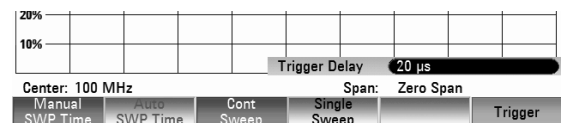

- Using the number keys, the cursor keys or the rotary knob, enter the delay and terminate the entry with the ENTER key or the TRIGGER softkey.

The trigger delay range is 0 µs to 100 s. The resolution is 10 µs up to 1 ms and 100 µs from 1 ms to 10 ms.

The trigger delay resolution depends on the delay selected. The table below lists the values:

Trigger delay (DELAY)	Resolution
0 to 1 ms	10 µs
1 ms to 10 ms	100 µs
10 ms to 100 ms	1 ms
100 ms to 1 s	10 ms
1 s to 10 s	100 ms
10 s to 100 s	1 s

Trace Settings

The R&S FSH provides two measurement traces and two reference traces in memory.

Trace mode

A variety of display modes can be selected for the trace:

- CLEAR/WRITE The R&S FSH clears the old trace during a new sweep. This is the default setting.
- AVERAGE The R&S FSH takes the level average over consecutive traces. In the default setting, averaging is on a pixel-by-pixel basis, sliding over the ten previous traces. Alternatively, you can set the number of averagings between 2 and 999. This reduces the effects of noise, for example, but has no effect on sine signals. The average mode, therefore, makes it easy to display sine signals in the vicinity of noise.
- MAX HOLD The trace indicates the maximum value that has been measured up to that point in time. The Max Hold mode is only cancelled if another setting is selected and the trace pixels from the new setting cannot be compared with the trace pixels from the previous setting – for example if the span is changed. Intermittent signals in the spectrum or the maximum of fluctuating signals are easy to find with MAX HOLD.
- MIN HOLD The trace indicates the minimum value that has been measured up to that point in time. The Min Hold mode is only cancelled if another setting is selected and the trace pixels from the new setting cannot be compared with the trace pixels from the previous setting – for example if the span or the center frequency is changed. With MIN HOLD, sine signals within the noise can be highlighted or intermittent signals suppressed.
- VIEW The R&S FSH freezes the presently displayed trace. The measurement is aborted. This, for instance, allows subsequent evaluation of spectra with the aid of the marker.

Operating sequence:

- Press the TRACE key.
- Press the TRACE MODE softkey.

The submenu for setting the trace mode opens.

- Using the cursor keys or the rotary knob, select the trace mode you want and confirm with the ENTER key or the TRACE MODE softkey.

The "Trace:" display at the center of the top of the display shows the trace mode that has been selected.

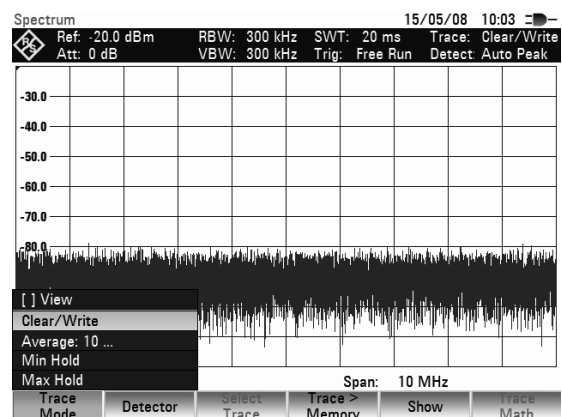

If TRACE MODE AVERAGE is selected, the AVG COUNT entry field opens, which displays the set number of averagings.

The following actions can be performed:

- Confirm the displayed number of averagings with the TRACE softkey or the ENTER key.
- Using the numeric keypad, enter a new figure between 2 and 999 for specifying the number of averagings and confirm your entry with the TRACE softkey or the ENTER key.
- Change the number of averagings by using the rotary knob and confirm your entry with the TRACE softkey or the ENTER key.

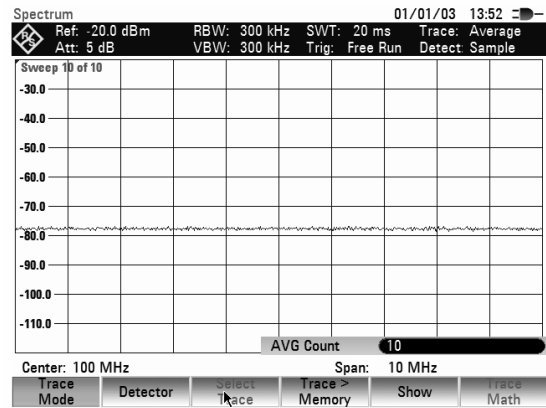

The R&S FSH averages the pixels of the trace across the set number of averagings.

If the sweep is continuous, the R&S FSH then performs a sliding averaging. In the SINGLE SWEEP mode, it performs exactly those sweeps defined with AVG COUNT and averages the traces. It then stops the sweep and displays the averaged trace.

In the trace mode VIEW, the settings used for measuring the trace are displayed. This ensures that the measurement conditions can be clearly specified in result documentation. In the status display (STATUS key) it is indicated in brackets that the view mode is currently selected, e.g. Trace Mode: Maximum Hold (View).

Detector

The detector processes a spectrum analyzer's video voltage before it is displayed. The detector is pixel-oriented, i.e. it determines how the level at each pixel will be displayed. The R&S FSH always measures the whole spectrum. However, the trace only has 631 pixels in the x direction for displaying results. If a large span is selected, all the spectrum information must somehow be represented using only 631 points. Each pixel represents a frequency range equal to $\text{span}/631$. Four different detectors are available:

- **AUTO PEAK**

When the Auto Peak detector is selected, the R&S FSH displays the maximum and minimum level at each pixel for the frequency range in question. This means that when Auto Peak detection is selected no signals are lost. If the signal level fluctuates, as is the case with noise, the width of the trace is a measure of signal fluctuation. Auto-peak detection is the default setting.
- **MAX PEAK**

Unlike the Auto Peak detector, the Max Peak detector only finds the maximum value within the frequency range associated with one trace pixel. Its use is recommended for measurements on pulse-like signals or FM signals.
- **MIN PEAK**

The Min Peak detector yields the minimum value of the spectrum within a pixel of the trace. Sine signals are displayed with correct level but noise-like signals are suppressed. The Min Peak detector can be used to highlight sine signals in the noise spectrum.

- SAMPLE

The Sample detector does not “summarize” any aspect of the spectrum which is available in its complete form in the R&S FSH, but instead shows only one arbitrary measurement point within a pixel. The Sample detector should always be used for measurements with span = 0 Hz, as this is the only way of correctly representing the timing of the video signal. The Sample detector can also be used to measure noise power as noise usually has a uniform spectrum with a normal amplitude distribution. If the Sample detector is used for signal spectrum measurements with a span that is greater than (resolution bandwidth x 631), signals may be lost.

- RMS

The RMS detector measures spectral power over a pixel. No matter what the signal shape, power measurements with the RMS detector always give the true power. RMS detection is recommended for power measurements on digitally modulated signals in particular. This is because the RMS detector is the only R&S FSH detector that can give stable, true power readings. Display stability can easily be obtained by increasing the sweep time, as the measurement time for the power/pixel increases the greater the sweep time. If you are making noise measurements, for example, the trace will be highly stable if a long sweep time is selected.

However, the bandwidth occupied by the signal to be measured should at least equal the frequency covered by a trace pixel or the selected resolution bandwidth (whichever is larger). Otherwise, the power shown by the R&S FSH is too low because there are spectral components within the frequency range covered by the pixel which do not come from the signal under measurement (e.g. noise).

To obtain the true power, the video bandwidth (VBW) too should be selected to be greater than the resolution bandwidth (RBW). Otherwise, an averaging effect caused by video bandlimiting comes into play before the RMS value is calculated.

Both automatic operation and manual operation are available for setting the detector. In automatic operation, the R&S FSH selects the detector that is suitable for the trace mode that is set. In manual operation, the selected detector is always maintained regardless of the trace mode.

Setting of the detector in automatic operation:

Trace mode	Detector
Clear/Write	Auto Peak
Average	Sample
Max Hold	Max Peak
Min Hold	Min Peak

Operating sequence:

- Press the TRACE key.
- Press the DETECTOR softkey.

The submenu for selecting the detector opens.

If automatic operation has been selected, the AUTO DETECTOR menu item is marked with X and the R&S FSH displays the detector that is set to match the trace mode that is set.

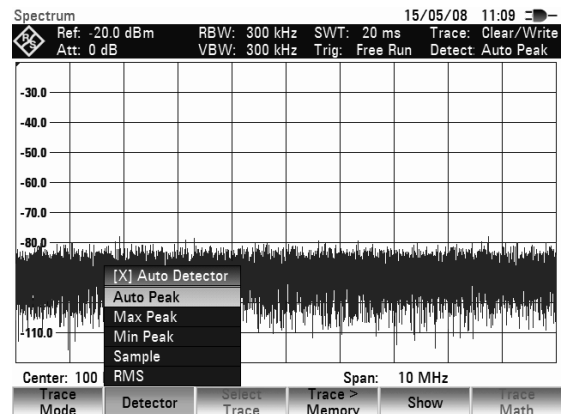

To switch automatic operation on or off:

- Using the cursor keys or rotary knob, select AUTO DETECTOR from the menu.
- Using the ENTER key or the DETECTOR softkey, switch automatic operation on or off.

When automatic operation is switched on, the R&S FSH also sets the detector that matches the trace mode that is set.

To set the detector manually:

- Using the cursor keys or the rotary knob, select the detector you want and confirm by pressing the ENTER key or the DETECTOR softkey.

The R&S FSH indicates the detector that has been selected in the top right-hand corner of the screen (Detect: Auto Peak in Fig. above). If AUTO DETECTOR is switched on and a detector that does not accommodate automatic operation is set, the R&S FSH will switch automatic operation off.

Trace-Selection

The R&S FSH can display two active traces TRACE 1 and TRACE 2 on the screen simultaneously. Each active trace is allocated a trace memory (MEMORY 1 or MEMORY 2). To establish to which measurement curve the control inputs are to refer, you must select a trace. All inputs relating to Trace mode, Detector, and copying of the trace into the Trace memory relate to the selected trace. In the default setting, TRACE 1 is selected for inputs.

Operating sequence:

- Press the TRACE key.
- Press the SELECT TRACE softkey.

Trace 2 is set instead of Trace 1. The selected trace is shown in the upper area of the screen (Trace 1 / Trace 2)

- Now apply the desired settings for Trace 2 (TRACE MODE / DETECTOR / TRACE > MEMORY).
- To change the settings of Trace 1, press the SELECT TRACE softkey again.

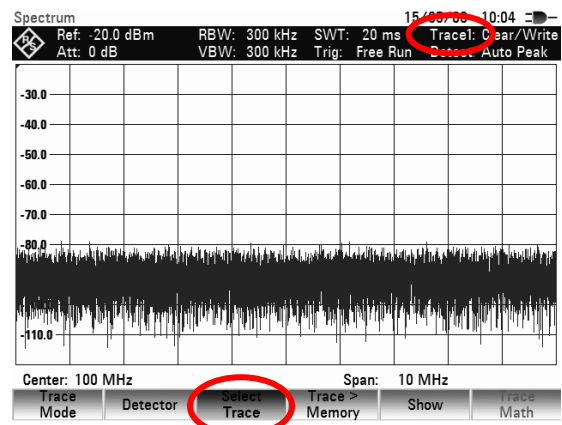

Trace memory

The R&S FSH can transfer a trace to the trace memory and also display the current trace and the trace in the trace memory for comparison. The saved trace is always displayed in white to distinguish it from the current trace.

Operating sequence:

- Press the TRACE key.
- Press the TRACE -> MEMORY softkey.

The R&S FSH transfers the selected trace (see Trace Selection) to the trace memory.

- Press the SHOW softkey.
- Select the desired memory trace from the menu using the cursor keys or rotary knob. Confirm the selection by pressing ENTER.

The R&S FSH displays the saved trace in white. The menu entry of the selected memory trace is marked with an X to indicate that the trace in the trace memory is being displayed.

- To remove the saved trace from the screen, press the SHOW softkey again.
- In the menu select the memory trace marked with X and confirm with ENTER.

The selected memory trace will be removed from the screen.

Note: *The memory traces are bit-mapped into the picture memory. Therefore, when the memory trace is recalled, it will not be adapted to any modifications of the reference level or span that may have been made in the meantime.*

When a stored data set is called, the R&S FSH stores the associated trace in the trace memory. The stored trace can be displayed with SHOW MEMORY.

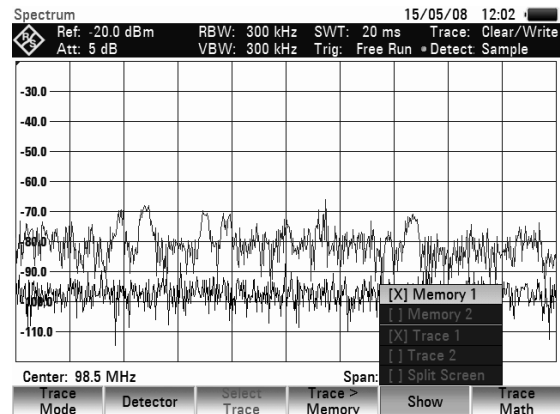

Trace mathematics

The R&S FSH can subtract a saved trace from the active trace and display the difference.

Operation:

- Press the TRACE key.
- Press the TRACE > MEMORY softkey.

The R&S FSH transfers the currently displayed trace to the trace memory.

- Press the SHOW softkey. Select the memory trace and confirm your selection with ENTER.

The R&S FSH displays the saved trace in white.

- To remove the saved trace from the screen, press the SHOW softkey again. Select the memory trace marked with X and confirm your selection again with ENTER.

- Press the TRACE MATH key and select TRACE – MEM or MEM – TRACE.

The R&S FSH displays the difference between the saved trace and the active trace.

- To remove the saved trace from the screen, press the TRACE MATH softkey again and select OFF.

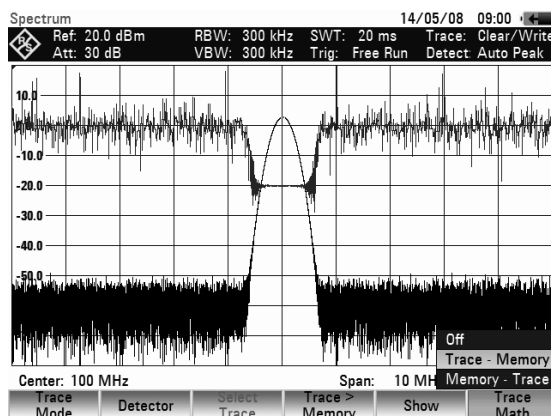

Using the Markers

The R&S FSH has six markers, five of which can be used as either marker or delta marker.

The markers cannot leave the trace and indicate the frequency and level of the point they are positioned on. The frequency indicated by a marker is shown by a vertical line which extends from the top to the bottom of the measurement diagram. The numeric frequency and level readouts are displayed in the top left-hand corner of the screen. The unit is the same as the unit of the reference level.

The position of the delta marker is indicated by a dashed line to distinguish it from the other marker. The delta marker level is always a level relative to the main marker level and so the delta marker level unit is always dB. The delta marker frequency is always relative to the main marker – in other words, the delta marker frequency is the frequency difference between the frequency at the point marked by the main marker and the frequency at the point marked by the delta marker.

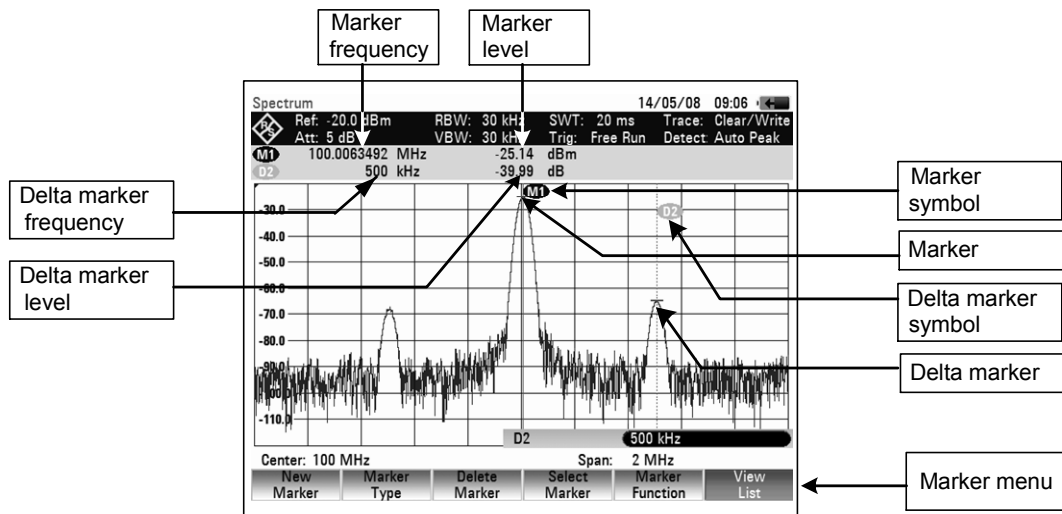

Controlling the marker:

- Press the MARKER key.

The marker menu opens. If, as yet, no marker has been activated, the main marker (MARKER) is turned on automatically and placed on the maximum level in the spectrum. The frequency and level at the point indicated by the marker are displayed at the top of the screen in the selected unit (= reference level unit). The value entry box for the marker frequency opens.

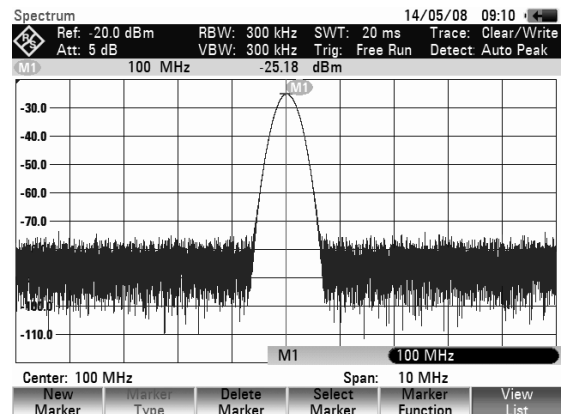

The following actions can now be performed:

- Change the marker position using the rotary knob or the cursor keys.
- Enter a marker position with the number keys and terminate the entry with one of the unit keys.
- Confirm the marker position by pressing the ENTER key.

Controlling the delta marker:

- Press the MARKER key.
- Press the NEW MARKER softkey.

The R&S FSH turns on the delta marker and places it on the second largest signal on the trace. The frequency and level displayed at the top of the screen are relative to the main marker, i.e. the R&S FSH always outputs the frequency difference and the level difference between the points marked by the main marker and the delta marker. Simultaneously, the value entry box for the delta marker frequency difference is opened.

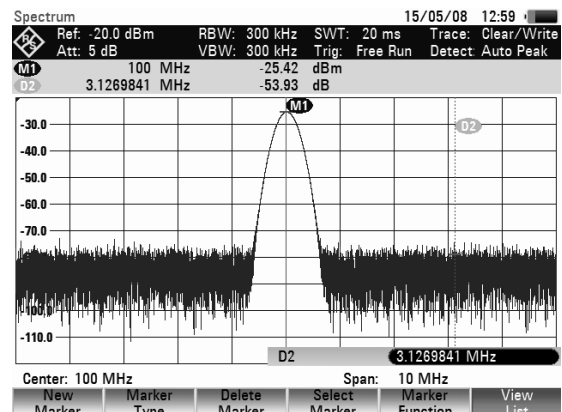

The following actions can now be performed:

- Change the delta marker position with the rotary knob or the cursor keys.

- Enter a delta marker position with the number keys and confirm with a unit key.
- Confirm the delta marker position by pressing the ENTER key.

Automatic marker positioning

The R&S FSH has functions that make setting markers easier or allow instrument settings to be made on the basis of the current marker position:

- PEAK This function places the marker or the delta marker on the highest value of the trace. The function acts on the active marker, whose associated softkey labelling is highlighted in red.
- NEXT PEAK Relative to their current positions, this function places the marker or the delta marker on the next highest peak of the trace.
- MINIMUM The marker or delta marker is placed on the lowest value of the trace. The function acts on the active marker. When the trace is displayed in the CLEAR/WRITE mode, the marker is placed on the lowest maximum of the trace.
- CENTER = MRK FREQ When this function is called, the center frequency (CENTER) is made equal to the current marker frequency or the delta marker frequency, depending on which marker is activated (softkey label highlighted in red). This function is particularly useful if you want to investigate a signal more closely using a smaller span. This is accomplished by first placing the signal in the center of the span and then reducing the span.
- REF LVL = MRK LVL This function makes the level indicated by the marker the reference level. This makes it easy to optimize the R&S FSH's level display range if the levels being investigated are low.

Operating sequence:

- Press the MKR-> key.
- Press the softkey with the desired marker function.

The R&S FSH then performs the action you have selected.

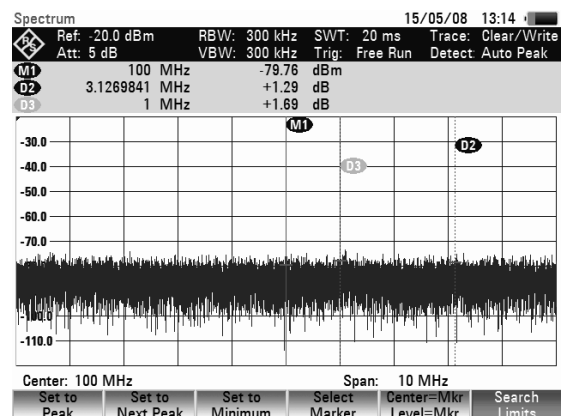

The R&S FSH allows you to use only a limited section of the trace for the PEAK, NEXT PEAK and MINIMUM functions. This is beneficial, for example, if you want to sample only spurious emissions with the marker search functions and want to omit useful signals.

- Press the SEARCH LIMITS softkey.
- Using the rotary knob or the cursor keys, select SEARCH LIMITS ON/OFF.
- Confirm your choice with the SEARCH LIMITS softkey or the ENTER key.

Der R&S FSH schaltet die Begrenzung des Marker-Suchbereichs ein. Zur Kennzeichnung des Bereichs werden zwei vertikale Linien im Diagramm eingeblendet.

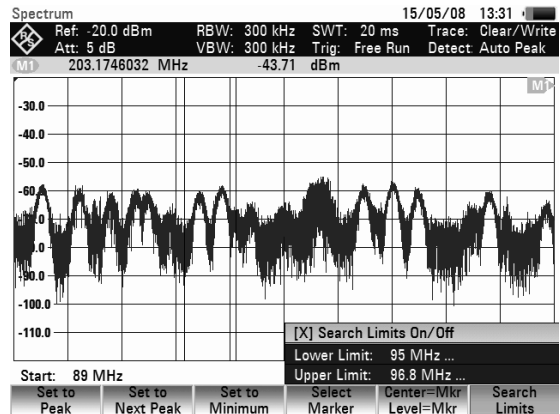

- For entering the start of the search range, press softkey SEARCH LIMITS.
- Select the LOWER LIMIT menu item with the rotary knob or the cursor keys and confirm your choice by pressing the SEARCH LIMITS softkey or the ENTER key.

The R&S FSH opens the entry field for the start frequency of the search range.

- Enter a start frequency with the numeric keys and terminate the entry with the desired unit or change the start frequency with the rotary knob or the cursor keys and terminate the entry with the ENTER key.

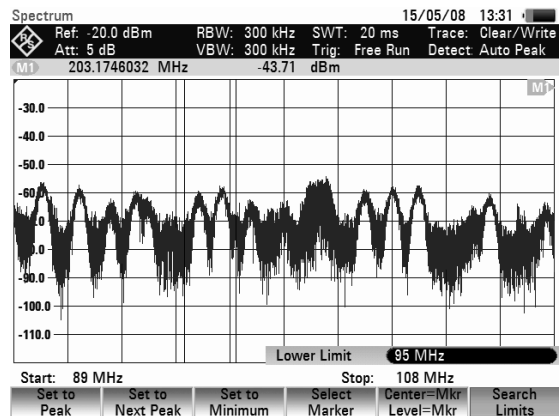

The R&S FSH indicates the start of the search range by means of a vertical line in the diagram.

The procedure for entering the stop frequency for the search range is analogous to that for entering the start frequency.

Deactivating the marker search range:

If a marker search range is activated, the softkey SEARCH LIMITS in the MKR-> menu is highlighted in green.

- Press the SEARCH LIMITS softkey to deactivate the marker search range.
 - Using the rotary knob or the cursor keys, select SEARCH LIMITS ON/OFF.
 - Deactivate the search in the limited range using the SEARCH LIMITS softkey or the ENTER key.
- the softkey SEARCH LIMITS is no longer highlighted.

Using more than one marker at a time (multimarker mode)

To measure different signals in a trace, the R&S FSH has the multimarker function. Up to six different markers are available. Marker 1 measures in absolute units. Markers 2 to 6 can measure in absolute units (marker) as well as relative units (delta). The reference for delta markers is always marker 1.

Operating sequence:

- Press the MARKER key.
- Press the NEW MARKER softkey several times. On each key-press a new marker will be created and placed on the next lower signal peak.

The marker designation contains the number of the marker in question (M1, D2, D3 etc.). The designation of the marker which is active for editing (= active marker) has a red background, whereas the other markers have a grey background.

As a default new markers are created as delta markers, which means that their position is displayed relative to marker 1.

- In order to transform a delta marker into a marker press softkey MARKER TYPE. The marker designation changes (e.g. D2 -> M2), and the marker position is displayed in absolute values.
- In order to select a previously created marker, press softkey SELECT MARKER repeatedly until the symbol of the desired marker is highlighted in red.

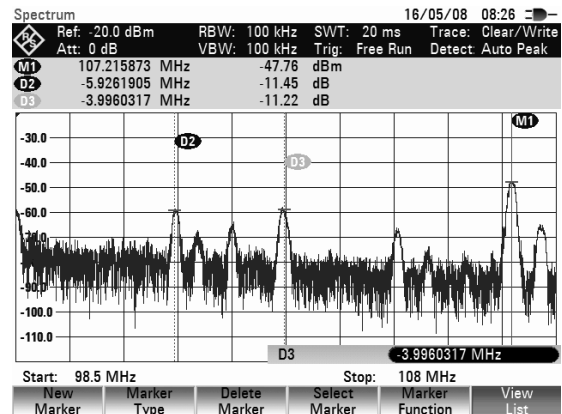

The R&S FSH opens the entry box for the frequency of the selected marker or the spacing between the delta marker and the reference marker M1.

- Using the cursor keys, place the marker or delta marker near the position you want. The step width here is 10 % of the X axis.
- Then use the rotary knob to fine-tune the marker or delta marker to the signal. The step width corresponds to the pixel spacing of the trace.
- Alternatively, enter the desired position of the marker or delta marker using the number keys and terminate the entry with one of the unit keys.

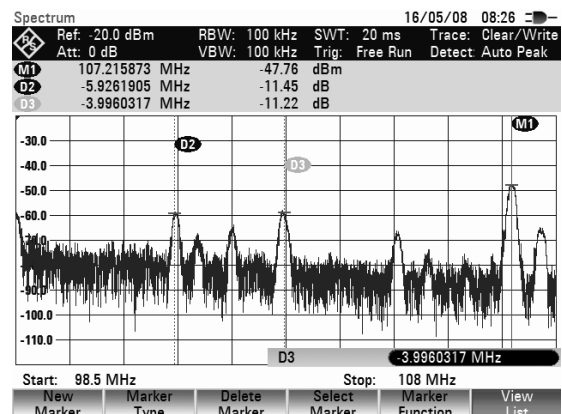

The R&S FSH displays the last edited marker or Delta marker (= active marker) by means of a red highlighted marker symbol. All marker functions relate to the active marker.

Automatic marker positioning:

Automatic positioning of markers in multimarker mode is similar to that of the normal marker. The different functions always apply to the active marker, which is also indicated for the various functions in the MKR-> menu (example: Selected Marker to Peak).

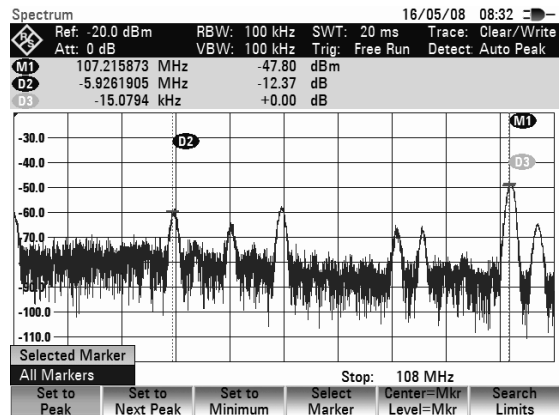

In addition, it is possible to position all activated markers (M1 to M6) at the peak of a trace.

- In the SET TO PEAK menu, select ALL MARKERS and confirm this with the ENTER key or the SET TO PEAK softkey.

The R&S FSH sets all activated markers to the maxima of the trace.

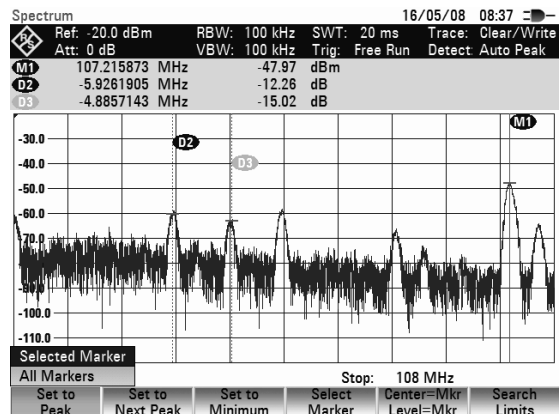

Displaying all multimarker values:

The R&S FSH can display a list of all activated markers and their values.

- Press the VIEW LIST softkey.

The R&S FSH displays a list of all activated markers and delta markers.

If you press the VIEW LIST softkey again, the R&S FSH closes the marker table extension from marker 3 to 6.

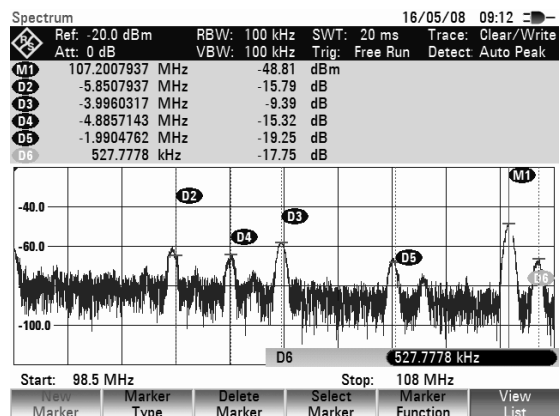

Deactivating markers:

Markers can be deactivated one at a time or all at once.

Deactivating markers or delta markers one at a time:

- Press the SELECT MARKER softkey repeatedly until the desired marker is highlighted in red.

The value entry field for the selected marker appears.

- Press the DELETE MARKER softkey.
- Now confirm the menu entry DELETE SELECTED by pressing ENTER.

This deletes the selected marker.

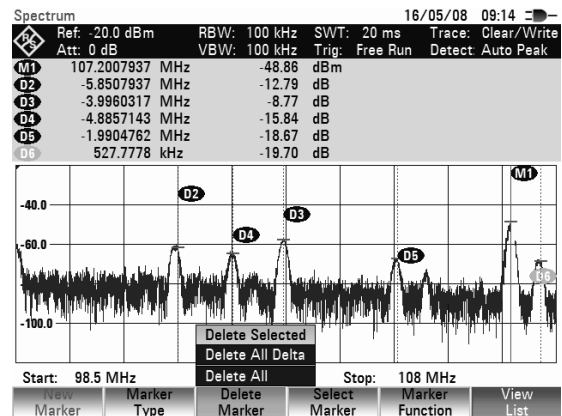

Note: If marker 1 (M1) is deactivated, the R&S FSH also deactivates all delta markers, because they use marker 1 as a reference.

Deactivating all markers or delta markers:

- Press the DELETE MARKER softkey.
- Using the rotary knob or the cursor keys select DELETE ALL DELTA or DELETE ALL
- Press the ENTER key or the DELETE MARKER softkey to switch off all markers and delta markers.

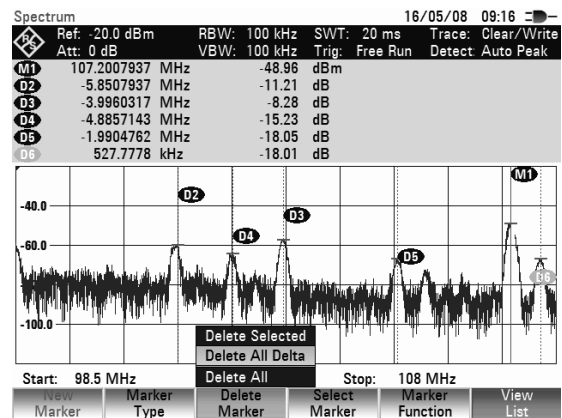

Note: When the markers are deactivated, the R&S FSH also deactivates all delta markers, because they use marker 1 as a reference.

Marker functions

Apart from displaying the level and frequency at the marker position (NORMAL setting), the R&S FSH can also perform other forms of analysis at the marker position. For example, the R&S FSH can calculate the noise power density referred to 1 Hz bandwidth (NOISE function) or measure the frequency of a signal at the marker position (FREQ COUNT function). The filter bandwidth or the signal bandwidth is measured with the N DB DOWN function.

Measuring the noise power density

The NOISE function is used to calculate the noise power density at the marker position. The R&S FSH calculates the noise power density in dBm/(1 Hz) from the trace pixel values, the selected resolution bandwidth, the detector and the level display mode (absolute or relative). To stabilize the noise power display, the R&S FSH uses the pixel on which the marker is positioned and the four pixels to the right and the four pixels to the left of the marker pixel. Noise power density can provide useful information when measurements are made on noise or digitally modulated signals. However, valid results are obtained only if the spectrum in the vicinity of the marker has a flat frequency response. The function gives incorrect results if measurements are made on discrete signals.

Operating sequence:

- Press the MARKER key.
- Press the MARKER FUNCTION softkey.
- Using the cursor keys or the rotary knob, select the NOISE menu item.
- Confirm the selection with the ENTER key or by pressing the MARKER FUNCTION softkey again.

The R&S FSH now indicates the marker level in dBm/Hz. If the delta marker is the active marker, it displays the result in dBc/Hz. The reading is referred to the main marker1.

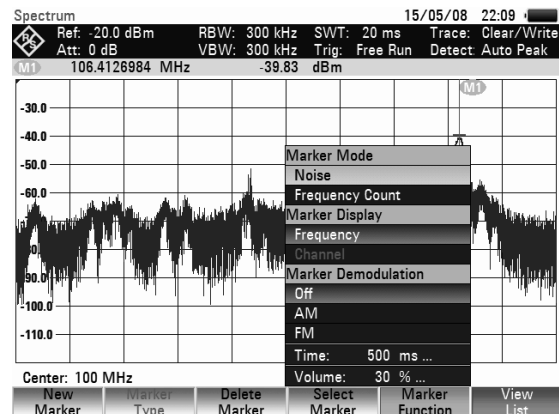
**Measuring the frequency**

The FREQUENCY COUNT function is used to measure the frequency at the marker position. The accuracy of the marker frequency readout is then no longer dependent on the pixel resolution of the trace, but only on the accuracy of the internal reference frequency.

The R&S FSH calculates the marker frequency from the center frequency, the span and the frequency of the trace pixel on which the marker is positioned. The trace has 631 pixels corresponding to 631 frequency coordinates. The frequency resolution is therefore relatively coarse – especially if a large span is set. To circumvent this problem, the R&S FSH's internal frequency counter can be used. When frequency measurements are being made, the R&S FSH briefly stops the sweep at the marker position and measures the frequency using the frequency counter. The resolution of the frequency counter is 0.1 Hz and so is considerably higher than the resolution that is obtained without the FREQUENCY COUNT function. Even though the resolution is high, frequency counting is extremely fast due to a special algorithm for the IQ baseband signal (approx. 30 ms at a resolution of 1 Hz). Basically, the accuracy of the frequency readout depends only on the accuracy of the internal reference frequency (TCXO).

The frequency counter only gives completely accurate readings for sine signals that are at least 20 dB above the noise floor. If the S/N ratio is less, noise affects the results.

Operating sequence:

- Press the MARKER key.
- Press the MARKER FUNCTION softkey.
- Using the cursor keys or the rotary knob, select the FREQUENCY COUNT menu item.
- Confirm the selection with the ENTER key or by pressing the MARKER FUNCTION softkey again.

The R&S FSH now displays the counted marker frequency with a resolution of 1 Hz. To indicate that the FREQUENCY COUNT function is on, the marker symbol changes from M1 to C1.

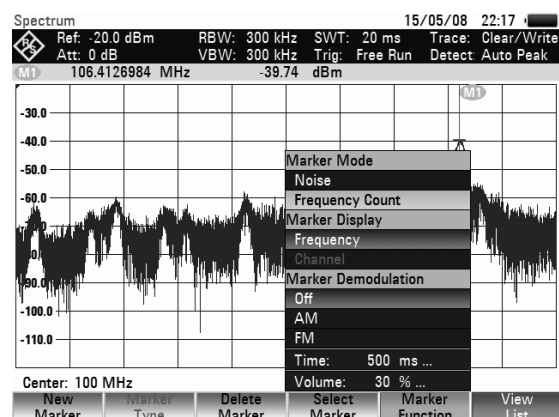

AF demodulation

The R&S FSH has an AM and FM demodulator for audiomonitoring signals. The demodulated AF signal can be listened to with the internal speaker or headphones (optional accessories). The headphones are connected to the 3.5 mm jack on the top side of the instrument. As the R&S FSH makes the uncontrolled video voltage audible in the case of AM demodulation, it is advisable to set the reference level so that the level of the signal to be demodulated is near the reference level.

When spectrum measurements are being made, the R&S FSH demodulates the signal at the marker frequency for a settable period of time. The sweep stops at the marker frequency for the demodulation period and then continues. If time-domain measurements are being made (span = 0 Hz), the R&S FSH performs continuous demodulation.

Operating sequence:

- Press the MARKER key.
- Press the MARKER FUNCTION softkey.

The submenu for setting demodulation parameters opens. If no markers have been activated, the R&S FSH automatically turns on the marker and positions it on the trace maximum.

- Using the cursor keys or the rotary knob, select the demodulation mode (AM or FM) you want and confirm your selection with the ENTER key.

Note: When the AF demodulation mode is selected, the R&S FSH automatically turns off the noise marker or the frequency counter.

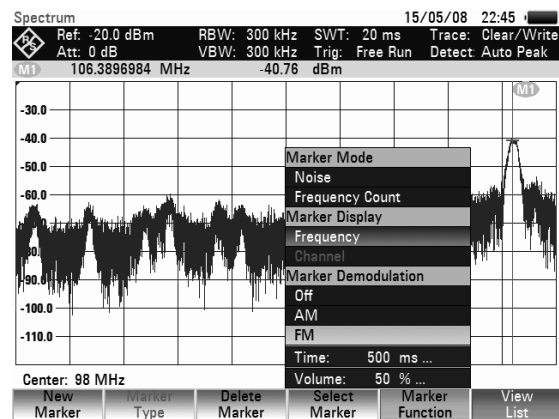

- To enter the demodulation time, select the TIME... item in the menu.

The currently set demodulation time is displayed in the value entry box. The demodulation time range is 100 ms to 500 s. If the R&S FSH is set to span = 0 Hz, the demodulation time setting is irrelevant as continuous demodulation is always performed.

- Change the time with the cursor keys or the rotary knob or enter a time using the number keys and confirm with the ENTER key.
- To adjust the volume, select the VOLUME... menu item and confirm your selection with the ENTER key.

The R&S FSH displays the volume in % in the value entry box. The volume range is 0 % (very low) to 100 % (full volume).

- Using the cursor keys or the rotary knob, adjust the volume or enter the volume in % using the number keys and confirm with the ENTER key.

Using the Display Line

In addition to the markers, the R&S FSH provides a horizontal line for determining the signal level in the display.

- Press the LINES key.
- Press the DISPLAY LINE softkey.

The R&S FSH displays a horizontal line across the entire diagram. The Y position of the line is indicated at the top left of the diagram (Line: -55 dBm in the diagram shown at the right).

- The line can be moved in the Y direction with the cursor keys or the rotary knob, or a level position can be entered with the numeric keys.

Terminate the entry with the ENTER key. The softkey label DISPLAY LINE is printed on a green background and the entry box is cleared.

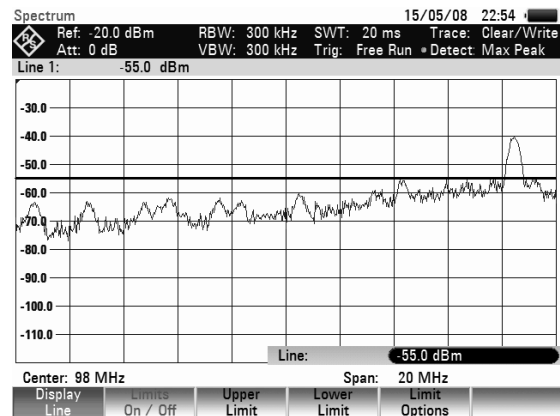

In contrast to the markers, the position of the displayed line is pixel-oriented. The line resolution in the Y direction therefore depends on the measurement range set in the Y direction. For a display range of 100 dB, it is 0.3 dB. When the line is set with the rotary knob, the R&S FSH always uses the step width of the display resolution in the Y direction, e.g. 0.3 dB for a 100 dB level measurement range. The cursor keys, on the other hand, always move the line by 10 % of the display range in the Y direction. For fast setting of the display line, we therefore recommend to set the line near the desired position with the cursor keys and then to use the rotary knob for fine adjustment.

Using Limit Lines

Limit lines are used to set limits for level characteristics versus time or versus frequency on the screen; they must not be exceeded. For instance, the upper limits of permissible spurious or harmonics of a DUT are marked by limit lines. In the R&S FSH, the upper and lower limit value can be preset by way of limit lines. Thus, a spectrum or level characteristic in the time domain (span = 0 Hz) can be checked either visually on the screen or automatically by verifying limit violations.

A limit line consists of at least two and at most 25 value pairs (points) on the x axis (frequency, time or length) and the y axis (level). The R&S FSH links the individual points by straight lines. The values on the x axis may be specified in absolute units (e.g. frequency in MHz) or relative units referenced to the center of the measured trace (e.g. center frequency). Relative units are of advantage, for instance, when modulated output signals are measured. If the center frequency is varied, the mask on the screen remains unchanged. The points on the y axis are always dB values. If the scale on the y axis is linear (unit V or W), the R&S FSH automatically switches to the respective dB unit after a limit line has been switched on.

Limit lines are defined with the aid of control software FSH4View. They are loaded into the memory of the R&S FSH via the USB- or the LAN-interface. Up to 100 limit lines can be stored simultaneously in the R&S FSH memory. The maximum number of limit lines may be reduced if transducer factors, channel tables, cable models, or data sets are stored simultaneously (see "Saving and Loading Instrument Settings and Measurement Results" in this chapter)

Operating sequence:

- Press the LINES key.

The softkey menu for the control of limit lines is displayed on the screen.

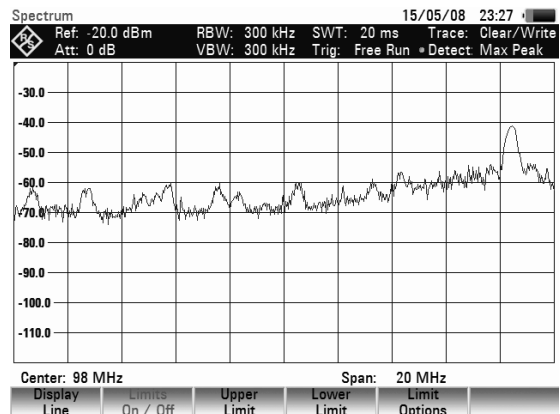

The R&S FSH makes a distinction between upper limit lines (UPPER LIMIT) and lower limit lines (LOWER LIMIT). It checks whether a measured value is above the upper limit line or below the lower limit line. The limit lines stored in the R&S FSH can be used to mark both upper and lower limit values.

- Depending on the application, press the UPPER LIMIT or LOWER LIMIT softkey.

The R&S FSH displays a list of available limit lines. If no limit line is switched on, the first value in the list is marked. If no limit lines are stored in the R&S FSH, the cursor will be placed on folder '\Public\.'

The screenshot shows the 'Select Limit Line' menu with the following data:

Stat	Name	Size	Date	Time
☞	\Public\.			
	Absolute Limit.abslim	1 kB	15/05/2008	23:34
	Fieldstrength.abslim	1 kB	15/05/2008	23:35
	FreqMask1.abslim	1 kB	15/05/2008	23:35
	PowerMask.abslim	1 kB	15/05/2008	23:34

Additional information at the bottom of the screen: Free: 27 MB, and softkeys: Select, Sort/Show, Internal/SD-Card, Exit.

The unit of the limit line and the unit currently set on the x axis must be identical. In order to determine which lines are compatible to the current settings, the compatible lines can be displayed:

- Press softkey SORT/SHOW.
- Select the item SHOW COMPATIBLE using the rotary knob or the cursor keys and confirm the selection with ENTER.

The R&S FSH will display only the limit lines which are compatible to the current instrument settings.

In order to display all lines again

- Press softkey SORT/SHOW.
- Select the item SHOW ALL using the rotary knob or the cursor keys and confirm the selection with ENTER.

The file name extension indicates whether the limit lines are assigned to absolute frequency, time or distance values (.abslim) or whether they are specified relative the center of the x axis (.rellim).

Switching on a limit line:

- Select the desired limit line from the list by means of the cursor keys or the rotary knob.
- Press SELECT to switch on the chosen limit line.

Exiting the list of limit lines:

Press the EXIT softkey to close the list of limit lines.

Switching off a limit line:

- Press LINES.
- Press softkey UPPER LIMIT / LOWER LIMIT.
- In the menu select DESELECT LIMIT using the rotary knob or the cursor keys and confirm with ENTER.

After a limit line has been switched on, the R&S FSH returns to the menu and the selected line is displayed in the diagram. The name and type of the limit line are also marked (UPPER LIMIT for an upper limit line and LOWER LIMIT for a lower line).

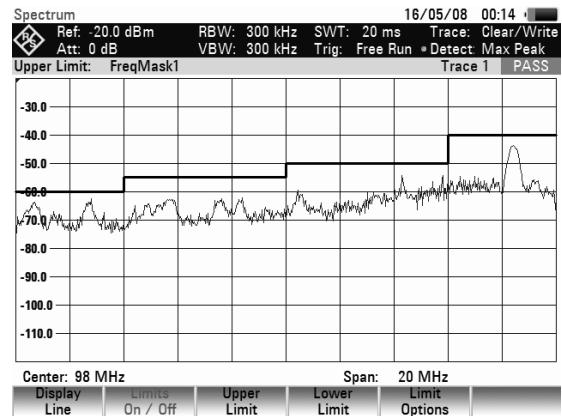

All active limit lines can be switched off together with the LIMITS ON/OFF softkey.

Measurements with limit lines

During a measurement, the R&S FSH checks the trace after each frequency sweep for upper and lower limit violations. If all measured values are within specified limits, PASS is displayed at the top in the center of the diagram. FAIL is indicated even if only a single measured value (= pixel of the trace) exceeds a limit value.

The automatic limit check can be switched off via softkey LIMITS ON/OFF. A limit violation can also be indicated by an acoustic signal.

Beep:

- Press the OPTIONS softkey.
- Select AUDIO BEEP with the rotary knob or the cursor keys and confirm the selection with the OPTIONS softkey or with the ENTER key.

If BEEP has been selected, the R&S FSH outputs a beep each time a limit is exceeded.

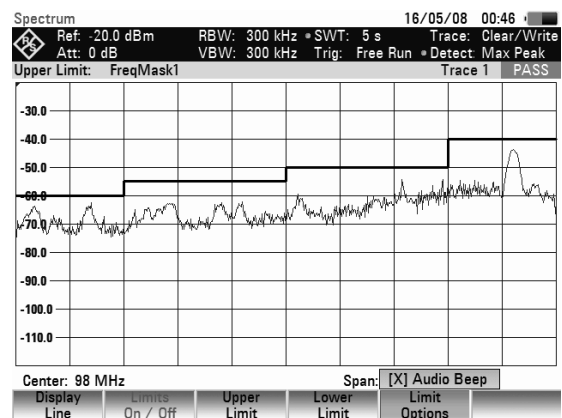

Definition range of limit lines

If a limit line is not defined in the entire frequency range or displayed span, a check is not performed outside the definition range.

Data sets containing limit lines

The R&S FSH stores data sets together with any limit lines that may have been active for the measurement in question. When such a data set is recalled, the associated limit lines are available too. They do however not appear in the list of limit lines.

Setting and Using the Measurement Functions

If you want to perform complex measurements, the R&S FSH provides measurement functions which perform certain measurement tasks with a minimum of keystrokes or, in conjunction with various accessories, will allow you to perform advanced measurements.

Measuring the channel power of continuously modulated signals

Due to the channel power measurement function, the power of modulated signals can be measured selectively. Unlike a power meter which measures power over its whole frequency range, the channel power mode allows the power in a specific transmission channel to be measured. Other signals in the frequency spectrum have no effect on the result.

When the channel power mode is selected, the R&S FSH determines the spectrum within the channel using a resolution bandwidth that is small in comparison with the channel bandwidth. The measured values on the trace are then integrated to give the total power. The R&S FSH takes into account the selected display mode (absolute or relative), the selected detector and the resolution bandwidth, which means that the result is comparable to the result that would have been obtained from a thermal power meter. The small resolution bandwidth acts like a narrow channel filter and so prevents out-of-channel emissions from affecting the result.

The R&S FSH has presets for the 3GPP WCDMA, cdmaOne and CDMA2000 1x systems and so the user does not have to enter any settings himself. However, user-defined channel settings can also be entered to set up the R&S FSH for other communications systems.

Operating sequence:

- Press the MEAS key.
- Press the MEASURE softkey.

The submenu for selecting the measurement functions opens.

- Using the rotary knob or the cursor keys, select the CHANNEL POWER menu item. (CHANNEL POWER highlighted in red)
- Confirm your selection with the ENTER key or the MEASURE softkey.

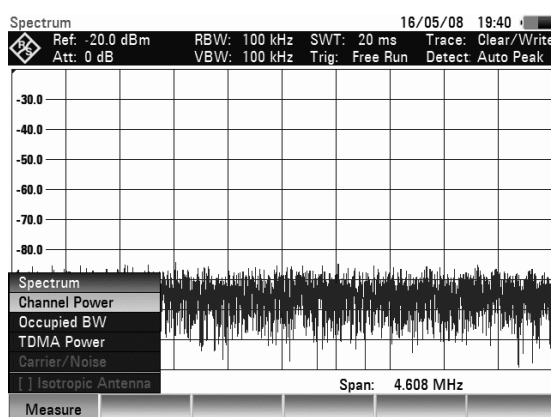

The R&S FSH displays the softkey menu for setting the channel power measurement. Two vertical lines in the measurement diagram indicate the channel bandwidth. The measured channel power is shown in large letters below the measurement diagram.

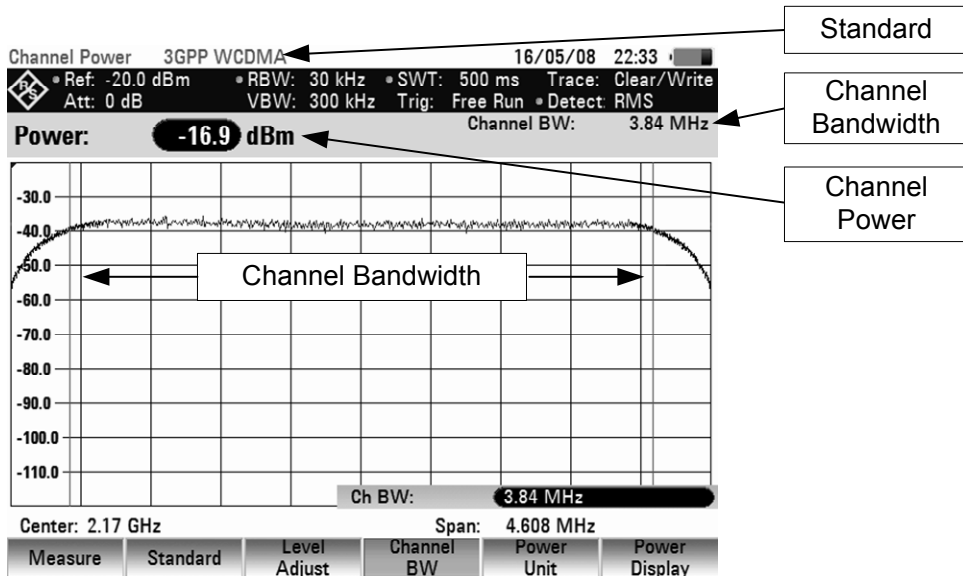

The default setting is power measurement for 3GPP WCDMA signals.

Selecting the standard

The R&S FSH has a channel power measurement default setting for various standards. It is also possible to define and save user-specified configurations.

- Press the STANDARD softkey.

A submenu with the available standards opens.

- Select the standard you want using the rotary knob or the cursor keys.
- Confirm your selection with the ENTER key or the STANDARD softkey.

The R&S FSH sets the selected standard. The optimal span, resolution bandwidth, video bandwidth, sweep time and detector for the standard are selected automatically.



Using the R&S FSH4View control software, additional standards can be generated and permanently loaded into the R&S FSH. You can also delete the factory-set standards provided in the instrument if you do not need them. The R&S FSH then offers only the standards you require, for example for measurements on TV signals.



Setting the reference level

When selecting the reference level, ensure that the R&S FSH is not overdriven. As the power is measured with a resolution bandwidth that is small in comparison with the signal bandwidth, the R&S FSH may still be overdriven even though the trace is still within the measurement diagram. To prevent the R&S FSH from being overdriven, the signal can be measured at the largest resolution bandwidth possible using the peak detector. If this setting is selected, it is not possible for the trace to exceed the reference level.

To simplify operation and to prevent incorrect measurements, the R&S FSH has an automatic routine for setting the reference level.

- Press the LEVEL ADJUST softkey.

The R&S FSH starts the measurement of the optimal reference level using a resolution bandwidth of 1 MHz, a video bandwidth of 1 MHz and the peak detector. During the measurement, the message "Adjusting level for channel power measurement, please wait..." is output.

The optimal reference level is then set.

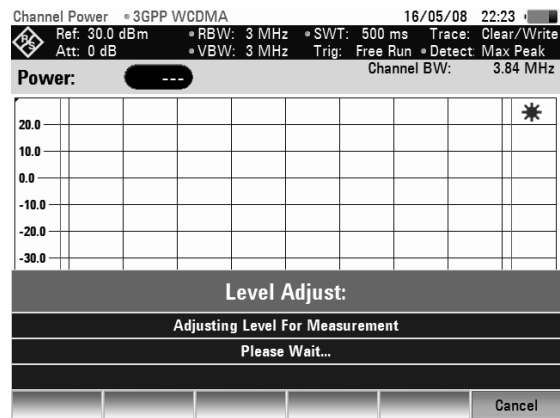

Setting the channel bandwidth

The channel bandwidth specifies the frequency range about the center frequency, over which the R&S FSH performs the power measurement.

- Press the CHAN BW softkey.

The value entry box showing the current channel bandwidth setting opens.

- Using the number keys enter a new channel bandwidth and terminate the entry with the appropriate unit, or
- Using the rotary knob or the cursor keys, change the channel bandwidth and confirm with the ENTER key or the CHANNEL BW softkey.

The R&S FSH automatically sets the appropriate span for the channel bandwidth that has been entered (span = 1.2 x channel bandwidth) to ensure that no incorrect channel power measurements are made.

The minimum channel bandwidth that can be set is 833 Hz at a span of 1 kHz.

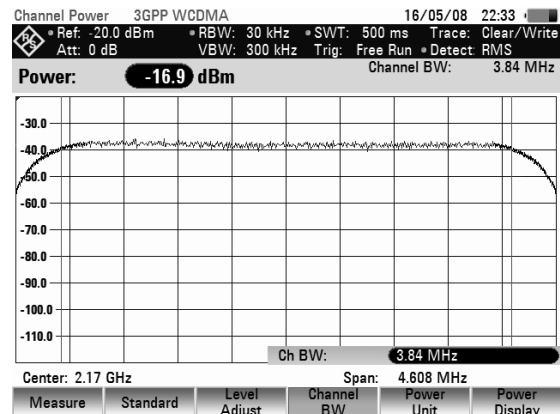

Changing the span

The span set by the R&S FSH yields extremely precise measurement results. However, signals in the environment of the measurement channel are no longer detectable. To enable users to see the spectrum outside the measurement channel, the span can be changed up to a factor of ten times the channel bandwidth during the channel power measurement.

Operation:

- Press the SPAN key.

The AUTO SPAN softkey label is highlighted in green to indicate that the optimum span for the channel power measurement is set. MANUAL SPAN is activated to allow immediate entry of another span.

- Using the numeric keys, enter a new span and terminate the entry with the appropriate unit, or
- Change the span with the rotary knob or the cursor keys and terminate the entry with the ENTER key or the MANUAL SPAN softkey.

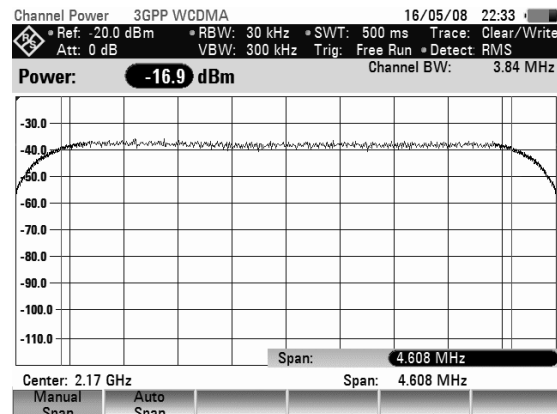

The largest permissible span for the channel power measurement is ten times the channel bandwidth. At larger spans, the result of the channel power measurement would be increasingly imprecise, because too few points of the trace occur in the channel to be measured.

- Press the AUTO SPAN softkey to again set the optimum span.
- To return to the menu for channel power measurement, press the MEAS key.

Measurement of maximum channel power:

If signal levels fluctuate significantly, you can define the maximum channel power by using the Max Hold function.

Operation:

- Press the POWER DISPLAY softkey.
- Select MAX HOLD by using the cursor keys or the rotary knob and then confirm with the POWER DISPLAY softkey or the ENTER key. The power display will switch from "Power" to "Max Power".
- To deactivate the Max Hold function, press the POWER DISPLAY softkey.
- Select CLEAR/WRITE by using the cursor keys or the rotary knob and confirm with the ENTER key. The power display will switch from "Max Power" to "Power".

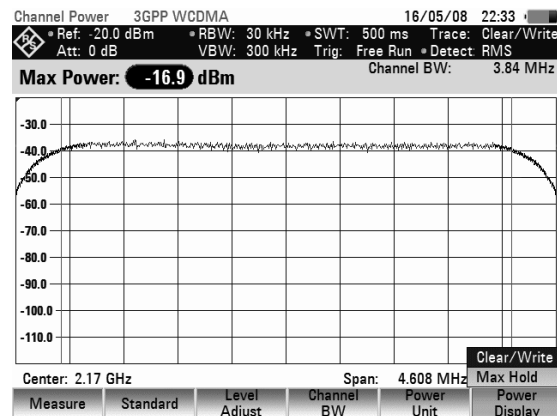

Unit for power display

The R&S FSH can use different units for power output. The basic unit is dBm.

- Press the PWR UNIT softkey.

The R&S FSH opens the submenu with the units: dBm, dBmV and dBμV.

- Using the rotary knob or the cursor keys, select the required unit.
- Confirm your selection with the ENTER key or the PWR UNIT softkey.

The R&S FSH displays the power level in the selected unit.

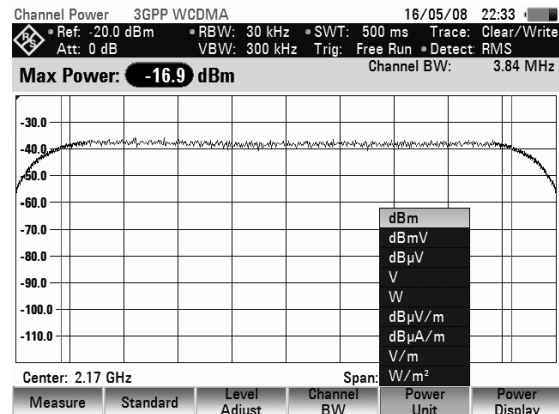

Power measurements on TDMA signals

When TDMA (time division multiple access) methods are used, e.g. for GSM, several users share a channel. Each user is assigned a period of time or timeslot. The R&S FSH's TDMA POWER function measures the power over one of these timeslots. This is a time-domain measurement (span = 0 Hz). The power measurement is started on an external trigger or the video trigger. The power measurement time is selected with MEAS TIME.

To prevent incorrect power measurements in the time domain, ensure that the whole signal lies within the selected resolution bandwidth. If the resolution bandwidth is too narrow, the displayed power will be lower than the actual power.

- Press the MEAS key.
- Press the MEASURE softkey.

The measurement function menu will open.

- Using the rotary knob or the cursor keys, select TDMA POWER.
- Confirm your selection with the ENTER key or the MEAS softkey.

The R&S FSH will display the softkeys for configuring time-domain power measurements.

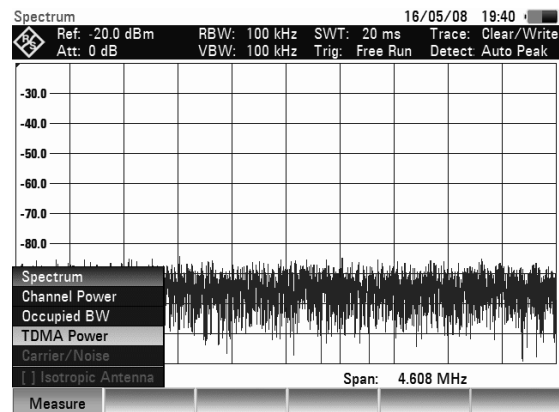

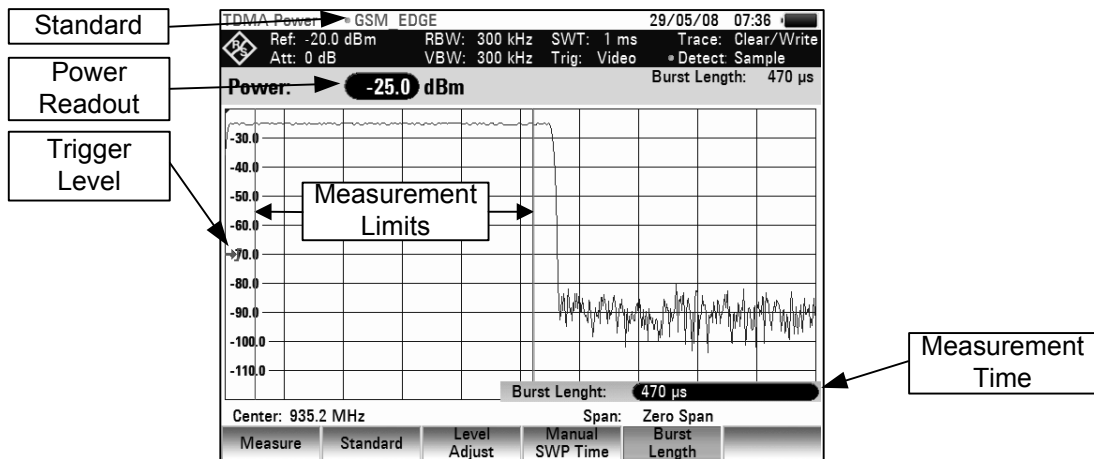

Selecting a standard

When the function is switched on, the R&S FSH automatically selects the GSM/EDGE standard. All default settings are selected so that power measurements on GSM or EDGE bursts give true readings.

Using the R&S FSH4View control software, additional standards can be generated and permanently loaded into the R&S FSH. You can also delete the factory-set standards provided in the instrument if you do not need them. The R&S FSH then offers only the standards you require.

Setting the burst length

The burst length is the measurement time over which the R&S FSH performs a power measurement. A value less than or equal to the sweep time can be selected.

- Press the BURST LENGTH softkey.
- The value entry box displaying the current measurement time opens.
- Using the number keys, enter a new measurement time and terminate the entry with the appropriate unit, or
 - Using the rotary knob or the cursor keys change the measurement time and confirm with the ENTER key or the BURST LENGTH softkey.

If the measurement time you have entered is greater than the sweep time, the R&S FSH sets a burst length equal to the sweep time. If you want to set a longer measurement time, you must increase the sweep time first.

The minimum burst length is the time corresponding to one trace pixel (= sweep time / 631).

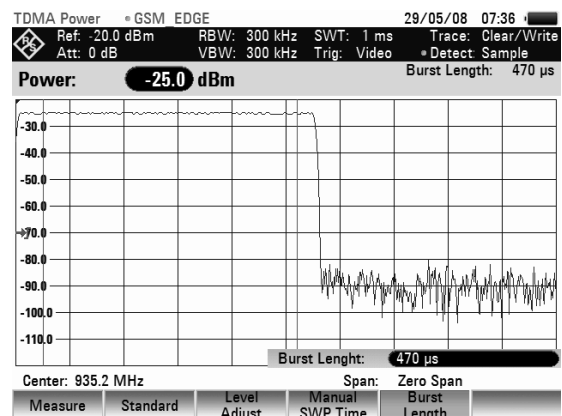

Optimizing the reference level

To obtain the greatest possible dynamic range for burst signals, the lowest reference level possible must be set. If this is not done, the R&S FSH will be overdriven by the measurement signal, if its maximum level exceeds the maximum reference level. Because the R&S FSH's resolution bandwidths are implemented digitally after the A/D converter, depending on the resolution bandwidth selected, the signal level at the A/D converter can be higher than the level indicated by the trace. To prevent the A/D converter from being overdriven, the signal must be measured at the widest resolution bandwidth (3 MHz) and video bandwidth (3 MHz) with the peak detector. The trace maximum then determines the optimal reference level.

The R&S FSH's LEVEL ADJUST routine will automatically determine the optimal reference level for you.

- Press the LEVEL ADJUST softkey.

The R&S FSH starts the measurement to determine the optimal reference level, using a resolution bandwidth of 3 MHz, a video bandwidth of 3 MHz and the peak detector. While the measurement is in progress, the R&S FSH outputs the message "Adjusting level for measurement, please wait...".

The optimal reference level is then set.

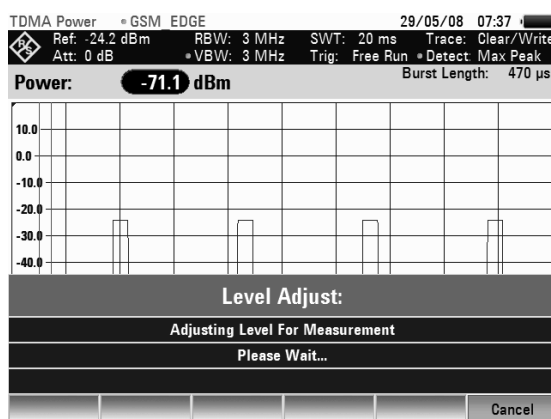

Power readout

The R&S FSH displays the measured power and the selected burst length above the measurement diagram (Power = nn.nn dBm).

Setting the trigger

A trigger is usually required to perform power measurements on bursts. In the default setting, the R&S FSH is configured to use the video trigger at 50 % of the Y scale on the measurement diagram. Assuming that the burst on which the measurement is to be made crosses the 50 % point of the trigger, the R&S FSH will trigger on the rising edge of the burst.

Should this not be the case, the trigger level must be adjusted so that the R&S FSH is triggered by the burst edge. Otherwise no measurement will be performed.

If the DUT has a trigger facility, the external trigger can also be used for the measurement.

- Connect the DUT's trigger output to the R&S FSH's trigger input.
- Press the SWEEP key.
- Press the TRIGGER softkey.
- Select the EXTERNAL RISE or EXTERNAL FALL menu item (rising or falling edge).
- Confirm your selection with the ENTER key or the TRIGGER softkey.

Select the appropriate trigger delay to position the burst in the measurement window.

- Press the TRIGGER softkey.

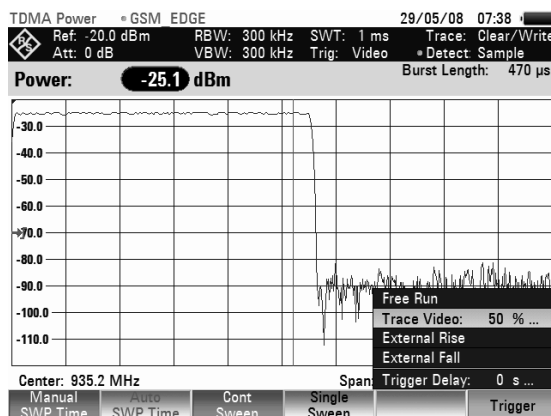

- Select the menu item TRIGGER DELAY by using the rotary knob and confirm with the ENTER key
- Using the rotary knob or the cursor keys, adjust the trigger delay until the TDMA burst is inside the vertical lines indicating the measurement range, or
- Using the number keys, enter the appropriate trigger delay and terminate the entry with the appropriate unit key.

Measuring the occupied bandwidth

Ensuring the proper operation of a transmission network requires that all transmitters adhere to the bandwidths assigned to them. The occupied bandwidth is defined as the bandwidth that contains a specified percent of the entire power of the transmitter. In the R&S FSH, the power percent can be set between 10 % and 99.9 %. Numerous standards require a percent of 99 %, which corresponds to the default setting of the R&S FSH.

One of the measurement functions of the R&S FSH is the measurement of occupied bandwidth. After the channel bandwidth has been entered, the R&S FSH automatically selects the measurement parameters so that an optimal result is attained.

Operation:

- Press the MEAS key.
- Press the MEASURE softkey.

The R&S FSH will open the measurement function menu.

- Using the rotary knob or the cursor keys, select OCCUPIED BW from the menu (highlighted in red).
- Confirm your selection with the ENTER key or the MEASURE softkey.

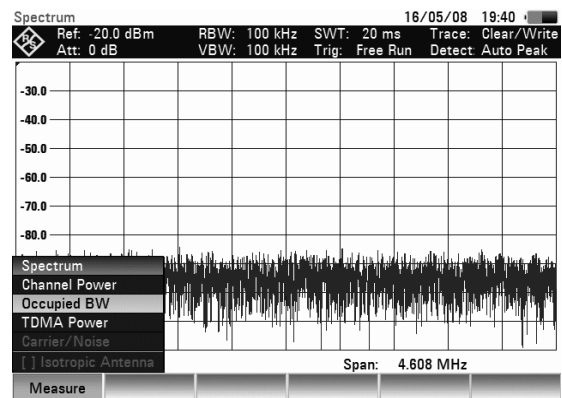

The R&S FSH displays the softkey menu for setting the measurement of occupied bandwidth. Two vertical lines in the measurement diagram indicate the occupied bandwidth. The measured numeric value (OBW) is shown in large characters above the measurement diagram.

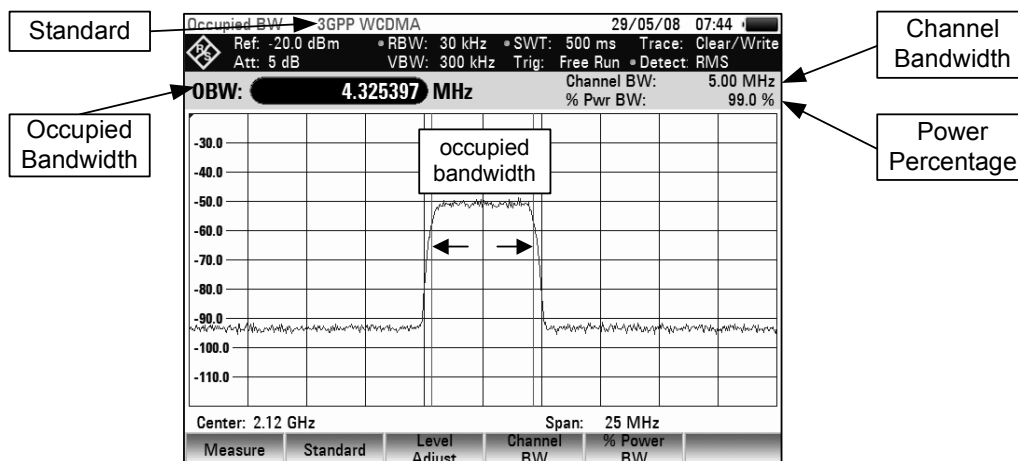

Selecting a standard

The R&S FSH offers a default for measuring the occupied bandwidth for different standards. It is also possible to define and save user-specific configurations.

- Press the STANDARD softkey.

A table with the available standards opens.

- Using the rotary knob or the cursor keys, select the appropriate standard.
- Confirm your selection with the ENTER key or the STANDARD softkey.

The selected standard is set. The optimal span, resolution bandwidth, video bandwidth, sweep time and detector for the standard are selected automatically.

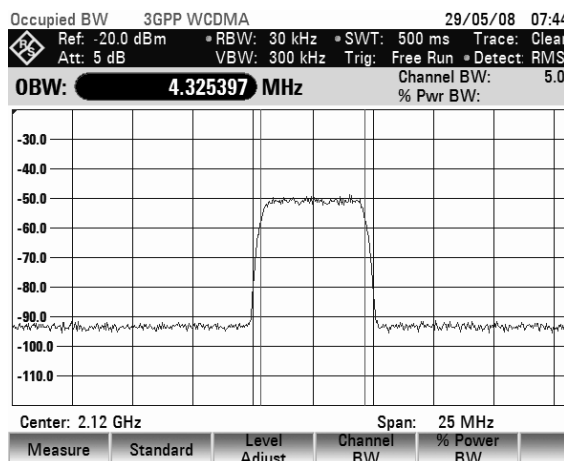

The following should be noted when changes to the settings are made:

- The span is always coupled to the channel bandwidth (CHANNEL BW). When changes are made, the R&S FSH automatically sets the appropriate span (= 5 x channel bandwidth).
- The resolution bandwidth should be between 1% and 4% of the channel bandwidth. This ensures that the occupied bandwidth is measured with high accuracy.
- The video bandwidth must be at least three times the resolution bandwidth. This prevents incorrect results due to the compression of signal peaks by the video filter.
- The RMS detector is recommended. This ensures that the power measurement is always correct irrespective of the waveform being investigated.
- The sweep time must be set so that the result is stable. If the sweep time is increased, the R&S FSH also increases the integration time for the RMS detector and thus ensures more stable measured values.

Using the R&S FSH4View control software, additional standards can be generated and permanently loaded into the R&S FSH. You can also delete the factory-set standards provided in the instrument if you do not need them. The R&S FSH then offers only the standards you require.

Setting the reference level

When selecting the reference level, ensure that the R&S FSH is not overdriven. As the power is measured with a resolution bandwidth that is small in comparison with the signal bandwidth, the R&S FSH may still be overdriven even though the trace is within the measurement diagram. To prevent the R&S FSH from being overdriven, the signal can be measured at the largest resolution bandwidth possible using the peak detector. If this setting is selected, the trace may not exceed the reference level.

To simplify operation and to prevent incorrect measurements, the R&S FSH has an automatic routine for setting the reference level.

- Press the LEVEL ADJUST softkey.

The R&S FSH starts the measurement of the optimal reference level using a resolution bandwidth of 3 MHz, a video bandwidth of 3 MHz and the peak detector. While the measurement is in progress, the R&S FSH outputs the message "Adjusting level for measurement, please wait...".

The optimal reference level is then set.

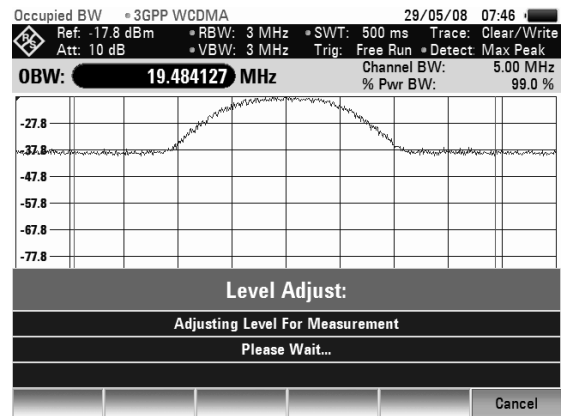

Setting the channel bandwidth

The channel bandwidth determines the span, resolution bandwidth and sweep time the R&S FSH uses for measuring the occupied bandwidth.

- Press the CHANNEL BW softkey.

An entry box showing the current channel bandwidth setting opens.

- Using the numeric keys, enter a new channel bandwidth and terminate the entry with the appropriate unit; or
- Change the channel bandwidth with the rotary knob or the cursor keys and terminate the entry with the ENTER key or the CHANNEL BW softkey.

The R&S FSH automatically adapts the span to the channel bandwidth that has been entered (span = 5 x channel bandwidth) to ensure that no incorrect measurements of occupied bandwidth are made. The minimum channel bandwidth that can be set is 2 kHz. If you attempt to enter a smaller channel bandwidth, the R&S FSH will automatically set 2 kHz.

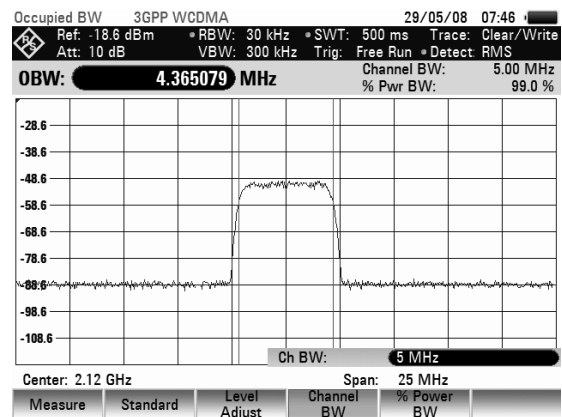

Entering the power percent to determine the occupied bandwidth

- Press the % POWER BW softkey.

The R&S FSH will open a field for entering the power percent relative to the total span power which defines the occupied bandwidth (percent of total power). The R&S FSH displays the value currently set.

- Using the rotary knob or the cursor keys, change the percent value, or enter a value using the numeric keys, and confirm the entry with the ENTER key or the % POWER BW softkey.

The R&S FSH will now display the occupied bandwidth of the specified percent of the total power.

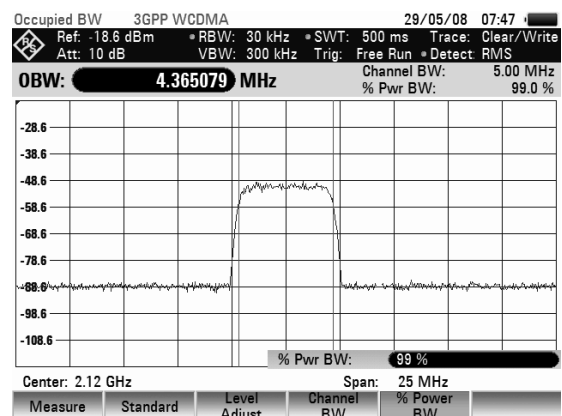

Displaying the occupied bandwidth

The R&S FSH now displays the occupied bandwidth (OBW: nnn.nn MHz) above the measurement diagram.

Changing the span

The span set by the R&S FSH normally yields optimum measurement results. In some cases, however, a larger span needs to be selected. This is the case, for example, when the area outside the span that is automatically set contains signal components that need to be included in the measurement.

Operation:

- Press the SPAN key.

The AUTO SPAN softkey label is highlighted in green to indicate that the optimum span for measuring the occupied bandwidth is set. MANUAL SPAN entry is active for immediate entry of another span.

- Using the numeric keys, enter a new span and terminate the entry with the appropriate unit, or
- Change the span with the rotary knob or the cursor keys and terminate the entry with the ENTER key or the MANUAL SPAN softkey.

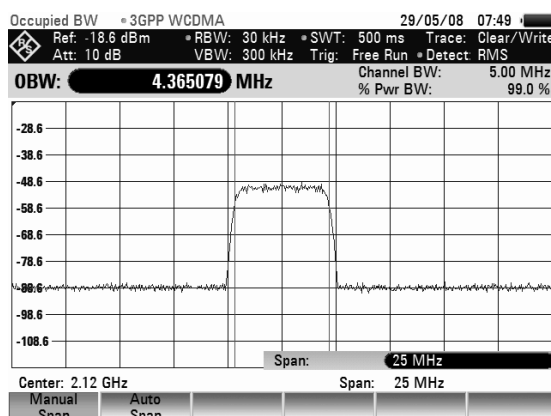

The largest permissible span for measuring the occupied bandwidth is ten times the channel bandwidth. At larger spans, the result of the channel power measurement would be increasingly imprecise, because too few points of the trace occur in the channel to be measured.

- Press the AUTO SPAN softkey to again set the optimum span.
- To return to the menu for measuring the occupied bandwidth, press the MEAS key.

Two-port measurements with the tracking generator

Only for R&S FSH with tracking generator (order number 1309.6000.14, 1309.6000.24, 1309.6000.18 or 1309.6000.28).

The R&S FSH can be supplied with an optional tracking generator to measure the transmission of two-ports or the reflection coefficients of one-ports and two-ports. The tracking generator outputs a signal at the current R&S FSH frequency. The nominal output level can be selected from 0 dBm to -50 dBm in 1 dB steps.

Two-port transmission can be determined directly by connecting the input of the DUT to the output of the tracking generator and the DUT's output to the R&S FSH's RF input. A bridge is required to measure the reflection coefficient, as included in the R&S FSH4 model, catalogue number 1309.6000.24 and the R&S FSH8, catalogue number 1309.6000.28. With current VSWR measuring bridges, the R&S FSH can carry out measurements in both the forward and backward directions. A two-port measurement object can thus be measured for impedance at the input and at the output and for the transmission in both directions.

Due to the calibration technique used, the R&S FSH's measurement accuracy is high for both transmission measurements and reflection measurements. The R&S FSH offers scalar calibration methods as standard; i.e. with transmission and reflection measurements, the magnitudes are corrected. Vector calibration methods and measurements (option R&S FSH-K42) are possible for

increasing the dynamic range and the measurement accuracy. The operation of vector measurements primarily differs in the expanded calibration routines. In addition, the R&S FSH-K42 option offers additional measurement functions for determining the phase, the group delay and the electrical length of a DUT.

- Press the MODE key.
- Press the NETWORK ANALYZER softkey.

The R&S FSH turns on the tracking generator and switches to its softkey menu. However, the frequency and level settings from the spectrum analyzer mode are not changed.

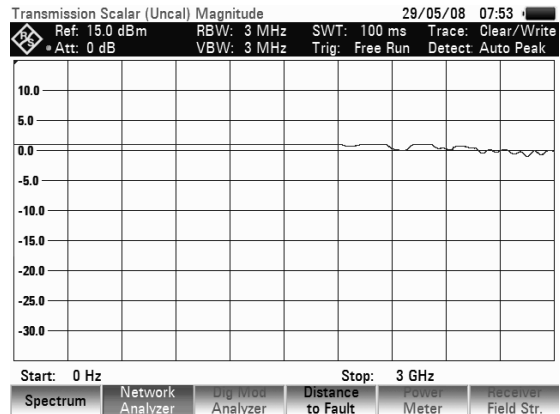

The softkey menu for the network analysis includes the softkeys for selecting measurement mode (scalar or vector, only available in devices with VSWR bridge), calibrating the transmission measurement (CALIBRATE TRANSMISSION FWD / REV) and reflection (CALIBRATE REFLECTION PORT 1 / 2). Calibration is necessary because the tracking generator output level does not exactly match the values specified in the table and it is frequency-dependent. If transmission measurements are performed on a two-port, the calibration takes the transmission characteristics of the test setup and the frequency response of the tracking generator into account and corrects the measurement with the correction data that has been obtained. When a reflection measurement is to be performed, during calibration the R&S FSH measures the reflection coefficient at a short and at an open on the bridge. These two measurements provide the correction data for reflection measurements.

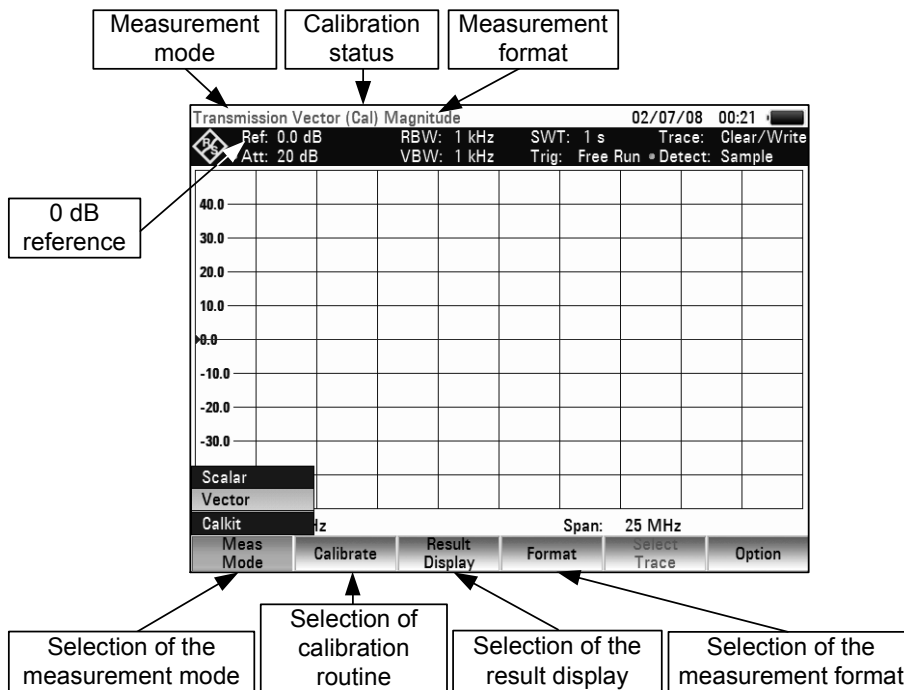

When the tracking generator is switched on, the status display indicates UNCAL. This indicates that tracking generator measurements are uncalibrated. The level axis is in the relative unit dB. Apart from the level values, the 0 dB reference is also displayed. This corresponds to a reference level of 0 dBm in the spectrum analyzer mode (= nominal output level of the tracking generator).

When the tracking generator is on, measurement parameters like bandwidth or the frequency range are selected with the appropriate keys as in the spectrum analyzer mode. When the MEAS key is pressed, the softkey menu for the tracking generator is displayed.

Before calibration, the output level of the tracking generator, the frequency range you want and the appropriate reference level should be set because calibration is only valid for the calibrated frequency range and reference. Changing these parameters after calibration invalidates calibration.

Note: The calibration remains valid if the start frequency, stop frequency, center frequency and span are subsequently changed within the calibrated frequency range. In this case, the R&S FSH interpolates the correction data between the reference points of the calibration. The R&S FSH retains the calibration values but displays a red dot before the tracking generator status display to indicate a possible increase in measurement uncertainty.

With an integrated VSWR bridge (models R&S FSH4, order number 1309.600.24 and R&S FSH8, order number 1309.600.28) the R&S FSH can measure the match at both the input and the output of a DUT and the transmission from input to output and vice versa (2-port capability). For this purpose, it internally switches the tracking generator to each of the required N-connectors, which are labelled port 1 and port 2 for this purpose.

Note: In spectrum analysis mode, port 1 is used as the RF input.

In devices which are not equipped with a VSWR bridge (Models R&S FSH4, order number 1309.600.14 and R&S FSH8, order number 1309.600.18), the generator output switching option is absent. These devices can therefore measure only the transmission from the tracking generator output (= port 2) to the RF input (= port 1) (TRANSMISSION REVERSE PORT 2 -> PORT 1). These devices also measure only the transmitted power (scalar measurement). The phase response cannot be measured by means of the measurement object.

Calibration is therefore available, regardless of the device model, in different versions:

Full Two-Port:	Reference measurements are performed for transmission and reflection measurement at both measurement ports (ports 1 and 2). This means that all measurements in "Network" mode are performed with maximum accuracy. The indication '(CAL)' shows in the status display. With regards to subsequent measurements at the DUT, this calibration method is the most flexible. However, it is also the most time-consuming, because all calibration standards (Open, Short, Load, Through) must be connected to both ports, which requires a total of seven measurement steps.
Reflection Port 1:	Performs vector reference measurements for later measurement of match or reflection at port 1. In this case, calibration requires the calibration standards to be connected to a single RF connector (3 measurement steps).
Transmission Fwd:	Performs vector reference measurements for the transmission from port 1 to port 2.
Transmission Rev:	Performs vector reference measurements for the transmission from port 2 to port 1.
Reflection Port 2:	Performs vector reference measurements for later measurement of match or reflection at port 2.
Normalize ...:	When selecting a normalization, a single reference measurement is made at the corresponding port or between both ports. By means of this reference measurement, for example, the frequency and phase response of a connected measurement cable can be compensated accurately enough without having to carry out a time-consuming full calibration. Note: In SCALAR mode and in instrument models without the VSWR bridge, only the NORMALIZE calibration type is provided.

Note: With an SD memory card inserted, you can toggle between internal memory and the memory card with the INTERNAL/SD-CARD softkey.

Setting the output level:

- Press the TG OUTPUT ATTENUATION softkey in the AMPT menu.

The input field for selecting the output level will open. The output level is set by selecting an attenuation value (0 dB to 50 dB). If you select 0 dB, the output level will be 0 dBm. If you select 50 dB, the output level will be -50 dBm.

- Using the numeric keys, the rotary knob or the cursor keys, define the attenuation value you want.

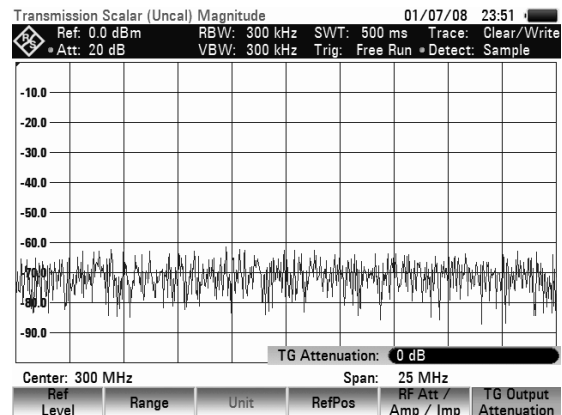

Measuring the transmission of two-ports

To perform a transmission measurement, connect the input of the DUT to the generator output and the DUT's output to the RF input of the R&S FSH. The R&S FSH measures the magnitude of the DUT's transmission. The operating sequence is explained below using a transmission measurement on a two-port filter with a center frequency of 2060 MHz and a bandwidth of approx. 11 MHz as an example. The measurement example starts with the R&S FSH in its default setting.

Setting the frequency range:

- Press the PRESET key.
- Press the MODE key.
- Press the NETWORK ANALYZER softkey.

The R&S FSH displays the tracking generator menu. As calibration has not been performed, UNCAL is displayed in the upper area of the measurement diagram.

- Press the FREQ key.
- Using the number keys, enter the center frequency (2060 MHz in this example).
- Press the SPAN key.
- Using the number keys, enter the span (50 MHz in this example).

Scalar transmission measurement:

- Press the MEAS key.
- Press the MEAS MODE softkey.
- Select SCALAR using the rotary knob and confirm with either the ENTER key or the MEAS MODE softkey.
- Press the CALIBRATE softkey.
- Select NORMALIZE TRANSMISSION FWD (PORT1 -> 2) using the rotary knob and confirm with the ENTER key or the CALIBRATE softkey.

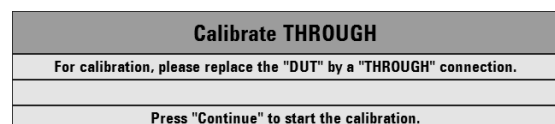

The R&S FSH now prompts you to connect its RF input to the tracking generator output so that calibration can be carried out.

- Connect the RF input of the R&S RSH3 directly to the tracking generator output without the DUT.
- Press the softkey CONTINUE to start calibration.
- To abort calibration, press the fourth or fifth softkey CANCEL.

When calibration is done, the R&S FSH outputs the message "Calibration done!" in the lower area of the display and (Cal) in the upper area of the display.

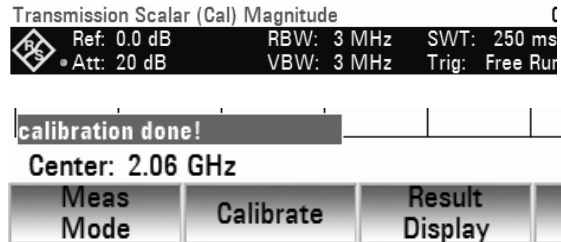

- Connect the DUT between the RF input and the generator's output.

The R&S FSH displays the transmission magnitude. Values can be read off with, for example, the markers.

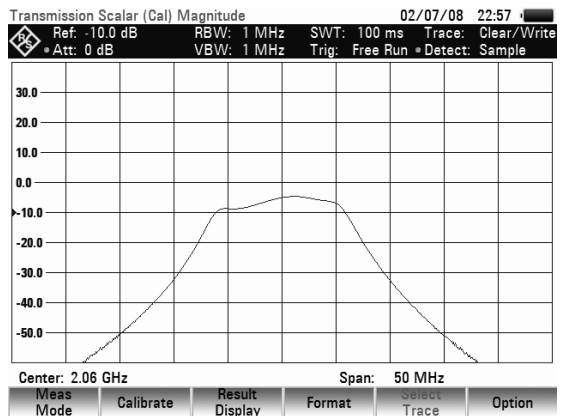

The transmission calibration remains valid until the center frequency or the span is changed on the R&S FSH to such an extent that the new span falls outside the calibrated frequency range. UNCAL is displayed in the upper area of the screen when calibration is no longer valid.

If the reference is changed after calibration, greater measurement uncertainty must be anticipated. The R&S FSH retains the calibration data but displays APPROX in the upper area of the screen to indicate a possible increase in measurement uncertainty (< 0.3 dB).

Changing any other of the parameters like bandwidth, detector, sweep time or measurement range has no effect on measurement accuracy. This means they can be changed after calibration without any reduction in accuracy.

When a data set for scalar transmission measurement is stored with calibration performed, the calibration data can be stored along with the other settings (see Chapter 2, section "Saving Calibration Data"). Thus, once the setting has been retrieved, measurement can be performed without first performing a calibration.

Measurement on amplifiers:

With measurements on amplifiers, the reference must be shifted so that the amplifier's transmission function can be seen on the screen. An increase of the reference level corresponds to an increase of the input attenuation. The R&S FSH provides a reference setting for this purpose. The position of the 0 dB reference can be shifted to positive or negative values.

- Press the AMPT key.
- Press the REF LEVEL softkey.
- Change the reference using the rotary knob or the cursor keys, or enter a new reference via the numeric keypad.
- Confirm the entry with the ENTER key or the REF LEVEL softkey.

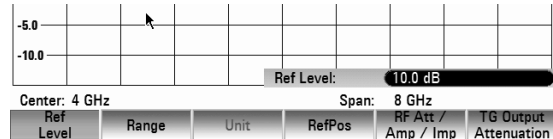

When performing measurements on amplifiers, make sure the R&S FSH is not overdriven. The risk of overdriving is eliminated when the trace is within the display area on the screen (with REF POSITION = 10 dB).

The reference can also be shifted without increasing the input attenuation – for example, in order to move the trace to the center of the screen. This is done using the REFPOS function. The values 0 to 10 indicate the horizontal lines from bottom to top (with 0 = bottom line, 10 = uppermost line). The value 5 indicates the center line of the diagram.

- Press the AMPT key.
- Press the REFPOS softkey.
- Change the reference position using the rotary knob or the cursor keys, or enter a new reference position via the numeric keypad.
- Confirm the entry with the ENTER key or the REFPOS softkey.

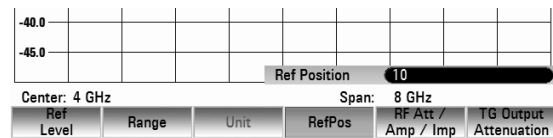

Vector measurement

(Only for R&S FSH4/8 with tracking generator and integrated VSWR bridge (order number 1309.6000.24 or 1309.6000.28) and R&S FSH-K42 (vector reflection and transmission measurement) option installed in conjunction with R&S FSH-Z28 or R&S FSH-Z29 (calibration standards)).

With vector measurements, the R&S FSH analyzes both magnitude and phase of the receive signal, thus correcting the influence it has on the measurement result by means of the complex correction values obtained from the calibration types with correct phase. Reference is made to the calibration standards used (through connection and 50 Ω termination).

Compared to scalar measurement, the vector transmission measurement yields higher measurement accuracy and dynamic range. One of the main benefits of vector measurement is that it also lets you determine the phase, group delay and electrical length of a DUT. These measurements are possible only after calibration has been performed; they remain disabled (command dimmed) until this is done.

For vector measurements, the following calibration types are available.

1. Full Two Port:

Both test ports are calibrated for a complete set of measurements (input reflection (S11), forward transmission (S21), reverse transmission (S12) and output reflection (S22)). The calibration routine therefore requires the connection of the standards load, open and short to both test ports, and a through connection of the test ports. The influences of the test setup and of the isolation between the test ports are thereby determined and taken into account in the subsequent measurement of the device under test.

While this method is the most time-consuming during calibration, it does provide the greatest accuracy for all measurements at both test ports without recalibration and is thus the most flexible.

Note:

The instrument is delivered with a full two port calibration (factory calibration). This does not, however, take into account the influence of the actual test setup (cabling). Thus all measurements are possible, even without further calibration, however, the accuracy is limited because the actual test setup is not taken into account. For this reason, the instrument indicates "(Uncal)" in the status line. To achieve the best possible measuring accuracy, we recommend that the calibration is repeated with the test setup in use.

2. Reflection Port 1:

Test port 1 is calibrated for the reflection measurement (S11). The calibration routine requires the calibration standards open, short and load to be connected one after another.

Note:

The instrument is delivered with a full two port calibration (factory calibration). If, after calibration of the reflection at port 1, other measurements (Transmission Fwd / Rev, Reflection Port 2) are selected, the R&S FSH uses the appropriate calibration data from the factory calibration. The measurements are thus possible but only with limited accuracy because the test setup in use is not taken into account. For this reason, the instrument indicates "(Uncal)" in the status line.

3. Transmission Fwd (Port 1 -> 2):

Forward transmission (S21) is calibrated. The calibration routine requires a through connection as well as the connection of the calibration standards open and short to Port 1. The influences of test setup and the isolation between the test ports are thereby determined and taken into account in the subsequent measurement of the device under test.

Note:

The instrument is delivered with a full two port calibration (factory calibration). If, after calibration of the forward transmission, other measurements (Transmission Rev, Reflection Port 1 / Port 2) are selected, the R&S FSH uses the appropriate calibration data from the factory calibration. The measurements are thus possible but only with limited accuracy because the test setup in use is not taken into account. For this reason, the instrument indicates "(Uncal)" in the status line.

4. Transmission Rev (Port 2 -> 1):

Reverse transmission (S12) is calibrated. The calibration routine requires a through connection as well as the connection of the calibration standards open and short to Port 2. The influences of the test setup and of the isolation between the test ports are thereby determined and taken into account in the subsequent measurement of the device under test.

Note:

The instrument is delivered with a full two port calibration (factory calibration). If, after calibration of the forward transmission, other measurements (Transmission Rev, Reflection Port 1 / Port 2) are selected, the R&S FSH uses the appropriate calibration data from the factory calibration. The measurements are thus possible but only with limited accuracy because the test setup in use is not taken into account. For this reason, the instrument indicates "(Uncal)" in the status line.

5. Reflection Port 2:

Test port 2 is calibrated for the reflection measurement (S22). The calibration routine requires the calibration standards open, short and load.

Note:

The instrument is delivered with a full two port calibration (factory calibration). If, after calibration of the reflection at port 1, other measurements (Transmission Fwd / Rev, Reflection Port 2) are selected, the R&S FSH uses the appropriate calibration data from the factory calibration. The measurements are thus possible but only with limited accuracy because the test setup in use is not taken into account. For this reason, the instrument indicates "(Uncal)" in the status line.

6. Normalize Reflection Port 1 (Short):

Test port 1 is calibrated for the reflection measurement (S11). The calibration routine requires only the calibration standard short. In the subsequent measurement, the isolation between the test ports is not taken into account, a possible cross-talk between the test ports in the test setup is not eliminated.

Note:

For the selection of other measurements, the same applies as for Reflection Port 1.

7. Normalize Reflection Port 2 (Short):

Test port 2 is calibrated for the reflection measurement (S22). The calibration routine requires only the calibration standard short. In the subsequent measurement, the isolation between the test ports is not taken into account, a possible cross-talk between the test ports in the test setup is not eliminated.

Note:

For the selection of other measurements, the same applies as for Reflection Port 2.

Vector transmission measurement

Switching on vector measurement:

- Press the MODE key.
- Press the NETWORK ANALYZER softkey.
- Select VECTOR from the MEAS MODE menu using the cursor keys or the rotary knob.
- Confirm your choice with the ENTER key or the MEAS MODE softkey.

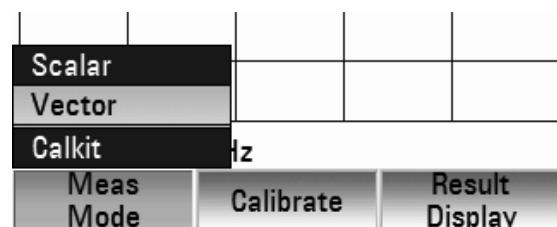

Calibrating the measurement:

Before the R&S FSH is calibrated, the desired center frequency and span must be set. If they are set later, the calibration values are lost and the measurement must be recalibrated.

Note: The calibration remains valid if the start frequency, stop frequency, center frequency and span are subsequently changed within the calibrated frequency range. In this case, the R&S FSH interpolates the correction data between the reference points of the calibration. The R&S FSH retains the calibration values but indicates a possible increase in measurement uncertainty by displaying (APPROX) in the upper area of the screen..

- Press the MEAS key.
- Press the CALIBRATION softkey.
- Select TRANSMISSION FWD (PORT1 -> 2) using the rotary knob and confirm with ENTER or the CALIBRATION softkey.

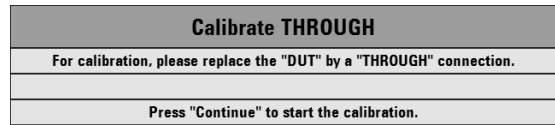

To calibrate the transfer measurement, the R&S FSH requests that the RF input be connected to the tracking generator output.

- Connect the RF input of the R&S FSH directly to the tracking generator output without the DUT.
- Press the CONTINUE softkey to start calibration.
- By pressing the CANCEL softkey, calibration can be aborted.

The R&S FSH then requests to terminate the output of the tracking generators into 50 Ω (LOAD).

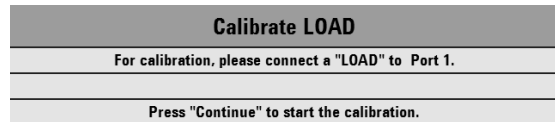

- Connect the generator output with the 50 Ω termination.
- Press the CONTINUE softkey.

When calibration is over, TRANSMISSION VECTOR (CAL) is displayed in the upper area of the screen to indicate that the R&S FSH is vector-calibrated for transmission measurement.

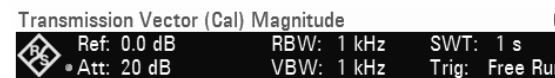

Setting the result display

The R&S FSH provides an option to change the results display so that the desired measurement result is displayed. You can then choose between reflection at port 1 or at port 2 (REFLECTION PORT 1 or REFLECTION PORT 2) or transmission in the forward or reverse direction (TRANSMISSION FWD (PORT 1->2) or TRANSMISSION REV (PORT 1->2)).

By default the R&S FSH displays the transmission in reverse direction (Port 2 -> Port 1)

- Press the RESULT DISPLAY softkey.
- Select the desired result display using the rotary knob or the cursor key and confirm with ENTER or the RESULT DISPLAY softkey

The R&S FSH now displays the selected measurement result on the screen.

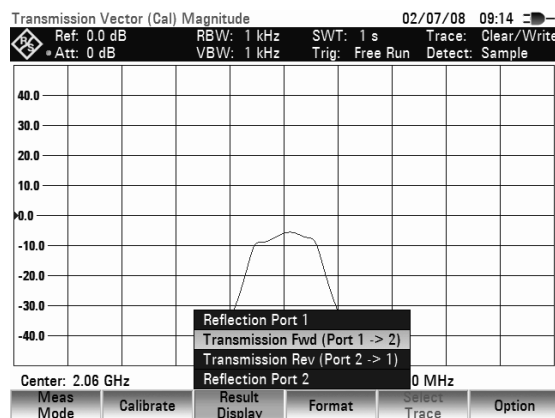

Measuring the transmission magnitude

Connect the DUT between the tracking generator output and the RF input.

- Press the FORMAT softkey.
- Using the rotary knob or the cursor keys, select MAGNITUDE from the menu and confirm by pressing either the FORMAT softkey or the ENTER key.

The R&S FSH will indicate the transmission magnitude and the message TRANSMISSION VECTOR (CAL) MAGNITUDE in the upper right-hand corner of the display.

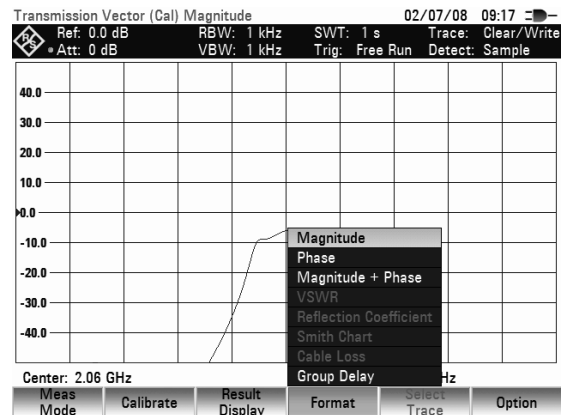

Setting of the reference position:

- Press the AMPT key
- Press the REFPOS softkey
- Using the rotary knob or the cursor keys, adjust the reference position or
- Using the numeric keys enter a new reference position and confirm with the ENTER key or the REFPOS softkey.

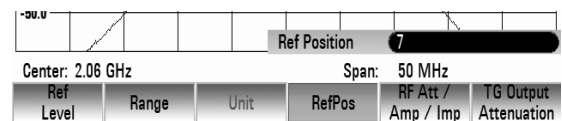

Measuring the transmission phase (models with integrated VSWR bridge only)

- Press the FORMAT softkey.
- Using the rotary knob or the cursor keys, select PHASE from the menu and confirm by pressing either the FORMAT softkey or the ENTER key.

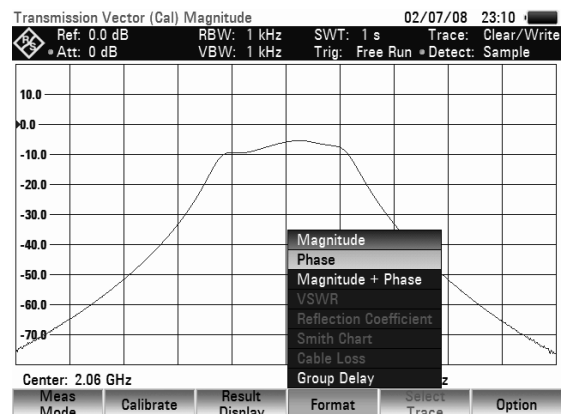

The R&S FSH displays the DUT's phase characteristic as a function of the frequency REFLECTION VECTOR (CAL) PHASE will appear in the upper area of the display. In the default scaling, the phase can only have values between -200° and $+200^\circ$.

Note: In the diagram's default scaling of -200° to $+200^\circ$, the trace will be shown correctly only if the phase difference between two adjacent test points is less than 180° .

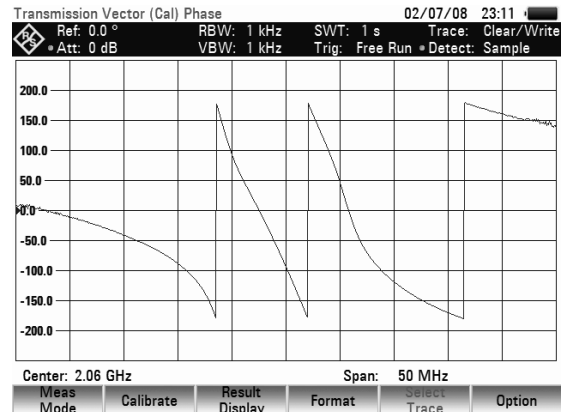

You can shift the reference of the phase measurement, for example to move the test trace to the center of the screen.

- Press the AMPT key.
- Press the REF POSITION softkey.
- Using the rotary knob or the cursor keys, change the reference position or enter a new reference position by using the numeric keys.
- Confirm by pressing the ENTER key or the REF POSITION softkey.

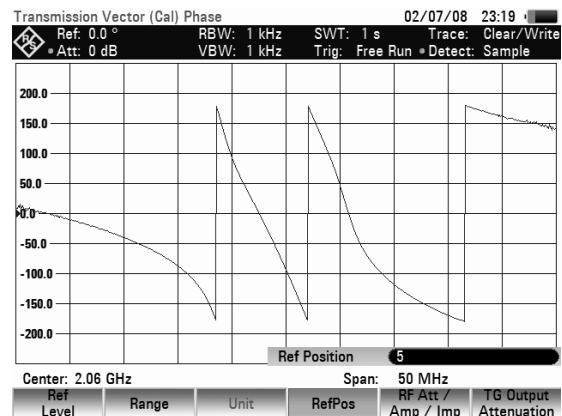

Supplying DC voltage to active DUTs (models with integrated VSWR bridge only)

By using the R&S FHS, DC voltage can be supplied to active DUTs such as amplifiers through the integrated bias tees (BIAS 1 and BIAS 2) via the RF cable. The DC voltage is fed in from a suitable external power supply (max. 600 mA/max. 50 V). To measure the antenna coupling of mobile radio base stations, the DC voltage must be supplied to two tower-mounted amplifiers (TMA). This is done by applying a suitable voltage at the BIAS 1 and BIAS 2 BNC inputs of the VSWR bridge.

Scalar measurement of reflection

The test setup must be calibrated before any measurements are made. This is done with a short and an open at the point where the reflection measurement is to be made. If a cable is to be inserted between the DUT and the bridge, perform the calibration at the measurement end of the cable.

- Press the MEAS MODE softkey and select SCALAR
- Press the CALIBRATE softkey.
- Using the rotary knob or the cursor keys, select the menu item NORMALIZE REFLECTION PORT 1 (SHORT).

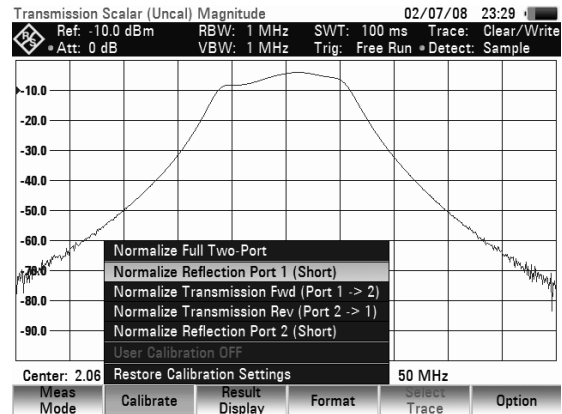

The R&S FSH prompts the user to connect an open to the measurement input.

- Connect an open to the measurement port of the bridge.
- By pressing CONTINUE, start the OPEN calibration.
- Press the CANCEL softkey to abort calibration.

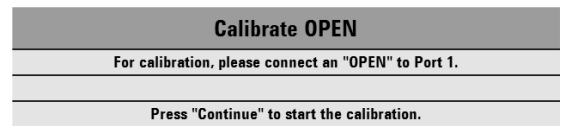

When OPEN calibration is done, the R&S FSH prompts the user to perform SHORT calibration.

- Connect a short to the measurement input of the bridge.
- Using CONTINUE start the SHORT calibration.
- Calibration can be aborted with CANCEL.

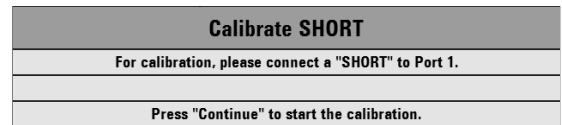

Note: Instead of a SHORT, the R&S FSH can be calibrated again with an OPEN. As the R&S FSH only measures the magnitude of the reflected voltage, it cannot distinguish between a SHORT and an OPEN. However, calibration with a SHORT increases measurement accuracy because the R&S FSH takes the average of the calibration values for the SHORT and the OPEN.

When calibration is done, the R&S FSH outputs the message "Calibration done!" for 3 seconds.

REFLECTION SCALAR (CAL) MAGNITUDE appears in the upper right-hand corner of the measurement diagram to indicate that the R&S FSH is calibrated for reflection measurements

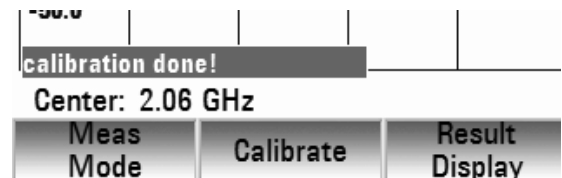

- Connect the DUT to the measurement port of the VSWR bridge.

The R&S FSH displays the return loss of the DUT.

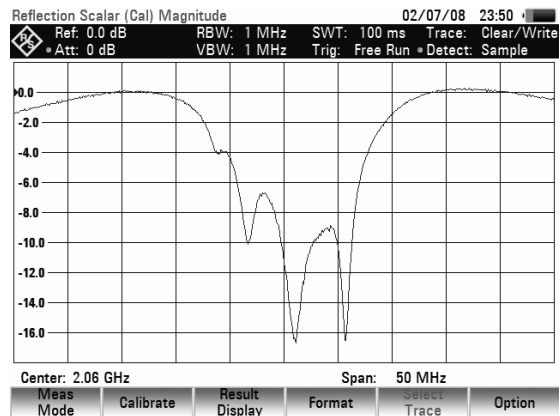

Entering the display unit:

- Press the AMPT key.
- Press the RANGE softkey.

The submenu for selecting the display ranges will open. The available display units depend on the selected reflection measurement format: return loss in dB, linear in %, standing wave ratio (VSWR), reflection coefficient (REFL COEFF (ROH)) and reflection coefficient (REFL COEFF (mROH)). Select the desired display unit by using the cursor keys or rotary knob.

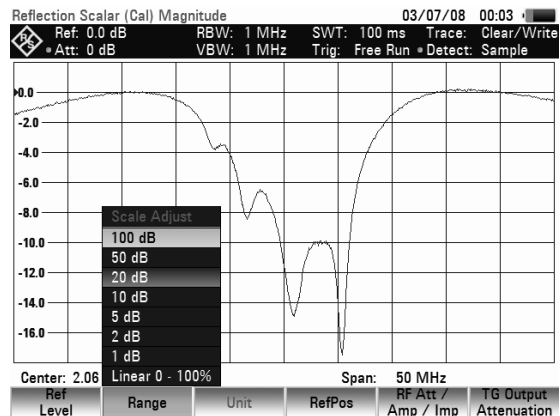

Note:

In the case of return loss and linear display, scaling is directly selected. In the case of all other units, a window for selecting the display range scaling opens. You can select a display range by using the cursor keys or the rotary knob.

Confirm the selection by pressing the ENTER key or the RANGE softkey.

The R&S FSH displays the reflection coefficient of the DUT.

The reflection calibration remains valid until the center frequency or the span is changed on the R&S FSH to such an extent that the new span falls outside the calibrated frequency range. UNCAL is displayed in the upper area of the screen when calibration is no longer valid.

If the reference is changed after calibration, a larger measurement uncertainty must be anticipated. The R&S FSH retains the calibration data but indicates a possible increase in measurement uncertainty by displaying APPROX in the upper area of the screen.

Changing other parameters like bandwidth, detector, sweep time or measurement range has no effect on measurement accuracy. This means they can be changed after calibration without any reduction in accuracy.

When a data set for scalar reflection measurement is stored with calibration performed, the calibration data can be stored along with the other settings (see Chapter 2, section "Saving Calibration Data"). Thus, once the setting has been retrieved, measurement can be performed without first performing a calibration.

Vector measurement of reflection

(only available for models with integrated VSWR bridge (order numbers 1309.6000.24 or 1309.6000.28) and equipped with with option R&S FSH-K42 in conjunction with option R&S FSH-Z28 and R&S FSH-Z29).

Unlike with scalar measurement, the R&S FSH corrects the waveform reflected by the DUT according to magnitude and phase by means of the correction values obtained from calibration. In addition to calibration with open circuit and short circuit, calibration with a 50 Ω termination is necessary. Thus, the characteristics of the VSWR bridge (directivity and impedances) no longer affect the measurement result. Rather, the decisive factor is the quality of the calibration parameters open circuit, short circuit and 50 Ω termination. Vector measurement therefore yields higher dynamic range and thus accuracy. Due to the higher dynamic range, the display ranges for the VSWR and VSWR 1 –1.5 and VSWR 1 – 1.1 have been expanded. As a result, extremely well matched DUTs can be measured more accurately and at a higher display resolution. However, a major advantage of the vector measurement is the capability to display the complex test results in a Smith chart. This allows for a much more detailed look at the DUT characteristics than with the reflection magnitude display as return loss, reflection coefficient or VSWR. Moreover, the vector reflection measurement allows you to determine the phase, the group delay and the electrical length of a DUT. The specified measurements become available only after calibration has been performed. With vector measurements, the R&S FSH sets the bandwidths (Res BW and Video BW) to a fixed, unchangeable value. It invariably uses the sample detector as a detector. All other measurement parameters can be set as with scalar measurement.

Switching on vector measurement:

- Press the MEAS MODE softkey.
- Select VECTOR from the menu using the cursor keys or the rotary knob.
- Confirm your choice with the ENTER key or the MEAS MODE softkey.

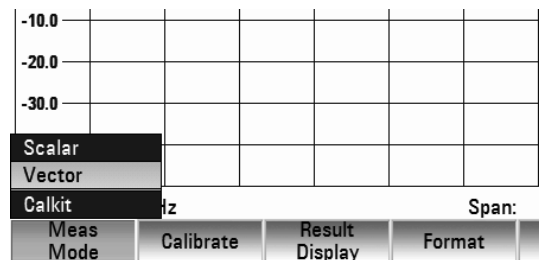

Calibration:

Before the R&S FSH is calibrated, the desired center frequency and span must be set. If they are set later, the calibration values are lost and the calibration must be repeated.

- Press the CALIBRATE softkey.
- Select REFLECTION PORT 1 using the rotary knob or the cursor keys and confirm by pressing the CALIBRATE softkey.

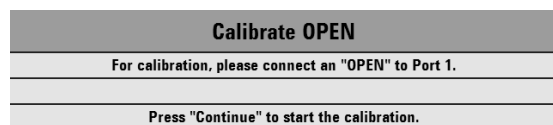

The R&S FSH displays a message requesting termination of the measurement input into an open circuit (Open).

- Terminate the measurement input of the VSWR bridge or the end of the measurement cable into an open circuit.
- Start open-circuit calibration by pressing CONTINUE.
- Calibration can be aborted at any stage with the CANCEL softkey.

When the open-circuit calibration is over, the R&S FSH outputs a message requesting the termination of the measurement port into a short circuit (SHORT).

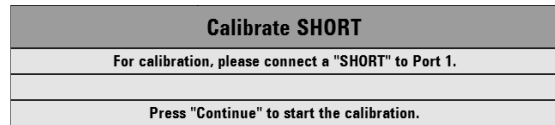

- Terminate the measurement input of the bridge or the end of the measurement cable into a short circuit.
- Start the short-circuit calibration by pressing CONTINUE.

In the third step of calibration, terminate the measurement port into a 50 Ω termination.

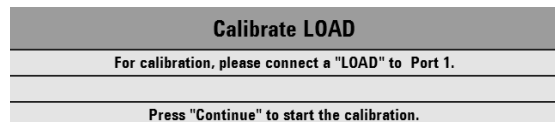

- Terminate the measurement input of the bridge or the end of the measurement cable into a 50 Ω termination (LOAD)
- Start termination calibration by pressing CONTINUE.

When calibration is done, the R&S FSH outputs the message "Reflect. calibrated" for three seconds.



REFLECTION VECTOR (CAL) is displayed in the upper area of the diagram.

This indicates that the R&S FSH is vector-calibrated for reflection measurements.

The reflection calibration remains valid until the center frequency or the span is changed on the R&S FSH to such an extent that the new span falls outside the calibrated frequency range. UNCAL is displayed in the upper area of the screen when calibration is no longer valid.

If the reference level is changed (AMPT key, REF LEVEL softkey) after calibration, greater measurement uncertainty must be anticipated. The R&S FSH retains the calibration data but indicates a possible increase in measurement uncertainty by displaying APPROX in the upper area of the screen.

A change in sweep time does not affect reflection measurement.

Measuring the reflection magnitude

Connect the DUT to the test port of the VSWR bridge.

- Press the FORMAT softkey.
- Using the rotary knob or the cursor keys, select MAGNITUDE from the menu and confirm by pressing either the FORMAT softkey or the ENTER key.

The R&S FSH shows the return loss magnitude in the upper area of the display. The changing of the display unit and the scaling of the display are described in the section "Scalar measurement of reflection".



Measuring the reflection phase

- Press the MEAS MODE softkey.
- Using the rotary knob or the cursor keys, select PHASE from the menu and confirm by pressing either the FORMAT softkey or the ENTER key.



The R&S FSH displays the DUT's phase characteristic as a function of the frequency. The R&S FSH shows REFLECTION VECTOR (CAL) PHASE in the upper area of the display. In the default scaling, the phase can only have values between -200° and $+200^\circ$.

Note: In the diagram's default scaling of -200° to $+200^\circ$, the trace will be shown correctly only if the phase difference between two adjacent test points is less than 180° .

For additional information on the scaling of the phase measurement, see section "Measuring the transmission phase".



Simultaneous measurement of magnitude and phase of the reflection

- Press the FORMAT softkey.
- Using the rotary knob or the cursor keys, select MAGNITUDE + PHASE and confirm with the MEAS MODE softkey or the ENTER key.



In the upper diagram the R&S FSH shows the magnitude of the reverse attenuation. In the lower diagram the phase curve of the DUT is shown as functions of frequency. In the upper area of the screen, the R&S FSH shows REFLECTION (CAL) MAGNITUDE + PHASE.

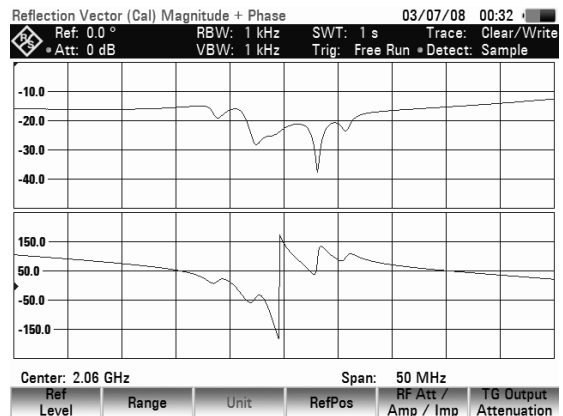

Displaying the reflection in the Smith chart

- Press the FORMAT softkey.
- Using the cursor keys or the rotary knob, select SMITH CHART from the menu.

Confirm the selection with the ENTER key or by pressing the MEAS MODE softkey again.

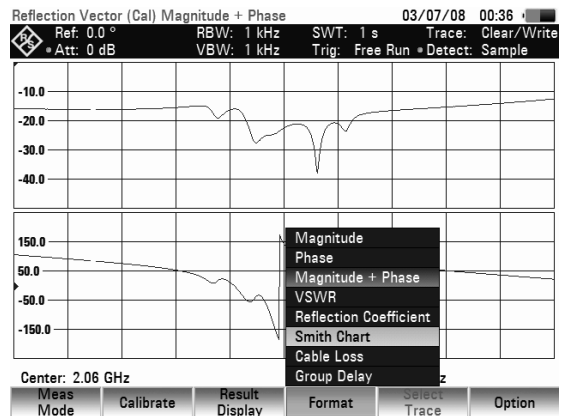

The R&S FSH will show the reflection of the DUT in the Smith chart.

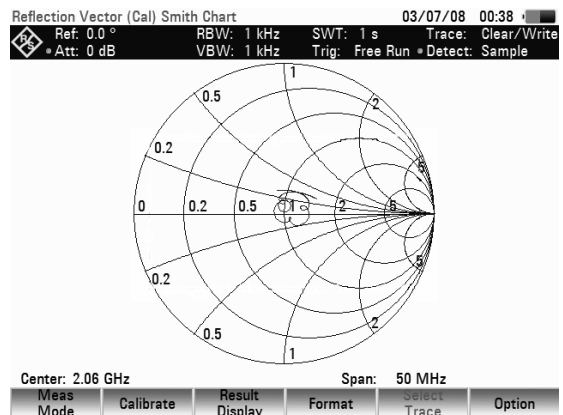

Using the markers in the Smith chart:

Like with the scalar measurement, the Smith chart display also provides all marker functions (marker, delta marker, multi-marker (see also section "Using the Markers"). The Smith chart also provides additional marker formats for vector reflection measurements.

Press the MARKER key. The R&S FSH will activate the marker menu and a marker.

- You can shift the marker on the complex reflection curve by using the rotary knob or the cursor keys, or by entering numeric values.

The marker values will first be output in numeric format with the marker frequency and the complex resistance ((real component) + j (imaginary component)) in Ω . If you need to display the complex reflection factor, for example, you can modify the marker format accordingly.

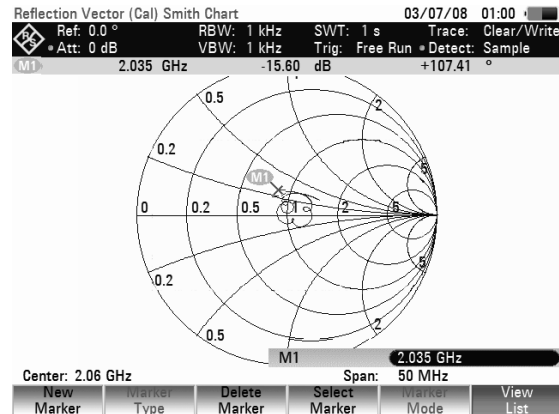
**Defining the reference impedance**

By default, the Smith chart is standardized to an impedance of 50 Ω . In other words, the matching point in the center of the Smith chart corresponds exactly to 50 Ω . However, reflection measurements using suitable matching networks and calibration standards can also be carried out in systems with different impedance values. In this case, the reference impedance for the Smith chart can be modified as needed.

- Press the MARKER MODE key.
- Using the rotary knob or the cursor keys, select REF IMPEDANCE 50 Ω from the menu and confirm by pressing either the MARKER MODE softkey or the ENTER key.

The R&S FSH opens a dialog box to enter the reference impedance. Any value between 1 m Ω and 10 k Ω can be entered.

Defining the reference impedance:

- Using the numeric keys, enter the desired reference impedance and confirm with MARKER MODE softkey or the ENTER key.

Zooming in on parts of the Smith chart:

To gain a better look at the measurement results, you can use the zoom function to enlarge any part of the Smith chart.

To activate the zoom function:

- Press the TRACE key.
- Press the ZOOM softkey.

The R&S FSH will display the menu for the zoom function, and a zoom window will appear in the Smith chart. You can change this window's size (zoom factor of 2, 4, or 8) and position.

To deactivate the zoom function:

- Press the EXIT softkey.

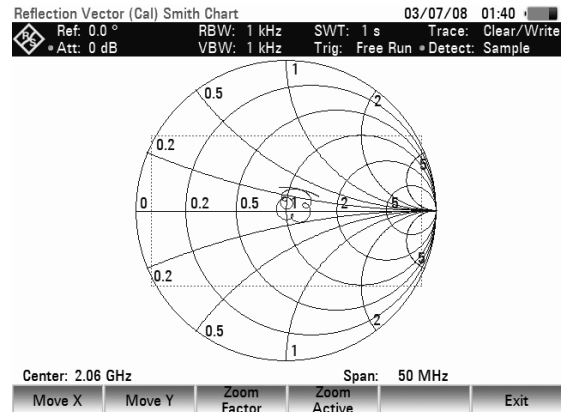

To define the zoom area:

Use the zoom factor to define the size of the zoom window or the zoom factor.

- Press the ZOOM FACTOR softkey.
- Select the desired zoom factor (2, 4 or 8) by using the rotary knob or cursor keys, or by entering a numeric value.
- Confirm the selection with the ENTER key or the ZOOM FACTOR softkey.

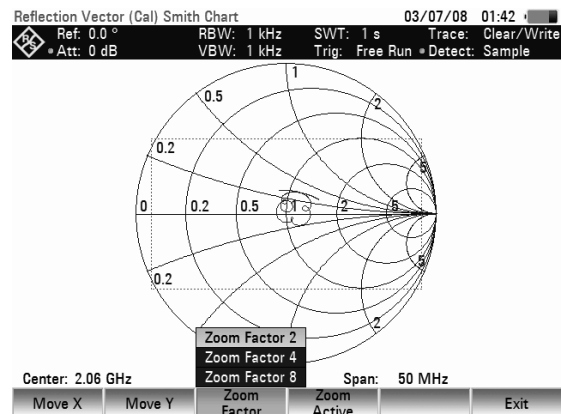

To shift the zoom window:

The reference point for shifting the zoom window in the x/y direction is the center of the Smith chart and the center of the zoom window. The shift value is specified as a percentage and ranges from -50% to + 50% for the x and y directions. The equation $x = y = 0\%$ corresponds to the center of the Smith chart.

To shift in the x direction:

- Press the MOVE X softkey.
- Set a value from -50% to +50% by using the rotary knob or cursor keys or by entering a numeric value.
- Confirm the selection with the ENTER key or the MOVE X softkey.

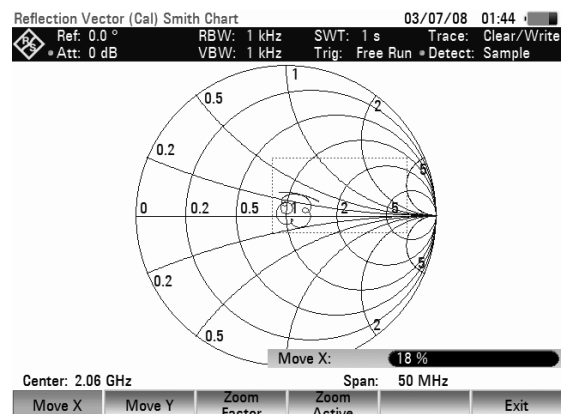

To shift in the y direction:

- Press the MOVE Y softkey.

- Set a value from -50% to +50% by using the rotary knob or cursor keys or by entering a numeric value.
- Confirm the selection with the ENTER key or the MOVE Y softkey.

To enlarge an area:

- Press the ZOOM ACTIVE softkey.

The selected window area will be enlarged by the zoom factor that has been set. You can fine-adjust the zoom window by using the MOVE X and MOVE Y as described.

To deactivate enlargement:

- Press the ZOOM ACTIVE softkey again.

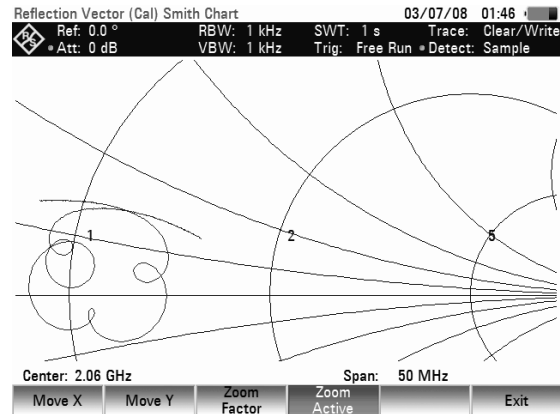

Selecting the calibration standards:

Selecting the calibration standards:

Optionally, the calibration standards R&S FSH-Z29 and R&S FSH-Z28 are available for the R&S FSH. The open and short calibration standards each have an electrical length of 5.27 mm. To eliminate the phase error that would result, the electrical length for the S_{11} measurement is corrected as standard. Standards other than R&S calibration standards can also be used. This is conditional on the difference in the electrical lengths of the open and short being as close to zero as possible. A length difference introduces an additional phase error. The R&S FSH can also post-correct a phase shift due to other cables and adapters that are used for S_{11} and S_{21} measurements.

Operating sequence:

- Press the MEAS MODE softkey.
- Select the menu item CALKIT... with the rotary knob or the cursor keys.

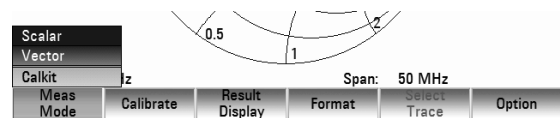

A further selection menu opens.

- With the rotary knob or the cursor keys, select USER SHORT (to enter the electrical length of the short) or USER OPEN (to enter the electrical length of the open).

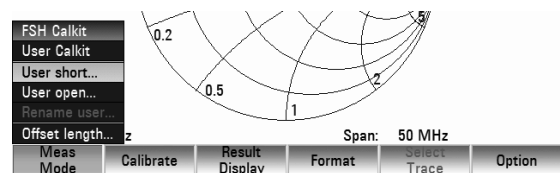

- Terminate the selection with the ENTER key or the MEAS MODE softkey.

- Using the cursor keys or the rotary knob, change the electrical length of the calibration standard employed, or, using the numeric keys, enter a value and terminate with the ENTER key.

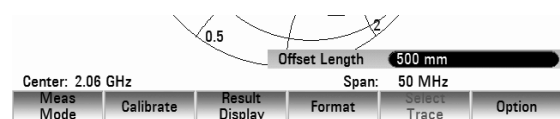

The electrical length of the calibration standard has now been taken into account for phase measurements and in the Smith chart.

Proceed as follows to use the R&S FSH-Z28 or R&S FSH-Z29 calibration standards:

- Select FSH CALKIT in the CALKIT menu with the rotary knob or the cursor keys.

To perform phase correction for additional cables and adapters proceed as follows:

- Select the menu item OFFSET LENGTH... in the CALKIT menu using the rotary knob or the cursor keys.
- Terminate the selection with the ENTER key or the MEAS MODE softkey.
- Using the cursor keys or the rotary knob, change the value for the additional electrical length of a cable or adapter or enter a value with the numeric keys and terminate with the ENTER key.

The additional electrical length is now taken into account for phase measurements and in the Smith chart.

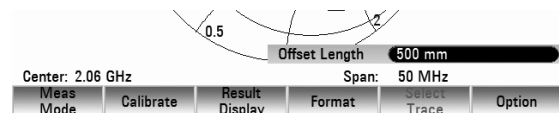
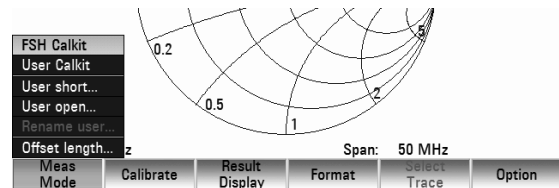

Renaming the USER calibration standard:

The setting for the USER calibration standard can be assigned a user-defined name. The name of the USER calibration standard which has been entered is then shown in the R&S FSH status display (STATUS key) so that, for example, the setting can be documented when the measurement is documented.

- Select Rename USER in the CALKIT menu with the rotary knob or the cursor keys.
- Terminate the selection with the ENTER key or the MEAS MODE softkey.

The R&S FSH opens the entry window for the name of the USER standard.

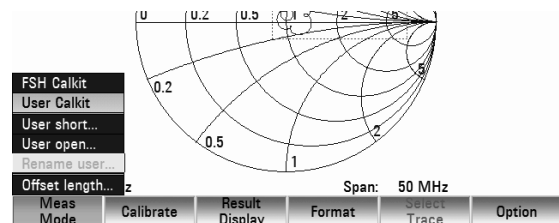

- Enter a name with the numeric keys.
- Terminate the entry with the ENTER key.

When the CALKIT menu is called, the name that has been entered is displayed in the USER menu item, e.g. calkit-1 (USER).

Cable Measurements

(Only for R&S FSH8 with tracking generator (catalogue number 1309.6000.18 or 1309.6000.28) and installed option R&S FSH-K41 (Distance-To-Fault Measurements) in conjunction with R&S FSH-Z20 (RF cable) and R&S FSH-Z28 or R&S FSH-Z29 (calibration standards).)

Measurements to determine the characteristics of cables to the antenna are key tasks when transmission equipment is being installed or maintained. Cable damage or bad connections have an adverse effect on the efficiency of the transmitter system. In conjunction with a tracking generator and the option "Distance-To-Fault Measurement" (DTF, R&S FSH-K41), the R&S FSH can locate cable faults and determine their distance from the measurement plane.

The only inputs required are the cable type and the approximate length. Using these parameters, the R&S FSH measures the distance to any faults and the degree of mismatch. It is easy to define the cable characteristics with the supplied "FSH4View" software package and to transfer them to the R&S FSH. Up to 100 cable types can be stored by the R&S FSH.

The R&S FSH measures the sum of the tracking generator signal and the signal reflected by the cable under test in the frequency domain. Depending on the phase of the signal reflected at a fault relative to the generator signal there is either reinforcement or cancellation. Because of this effect there is ripple on the received sum signal in the frequency domain. The R&S FSH fast Fourier transforms the received signal to the time domain. Using the characteristic data of the cable under test, the R&S FSH directly calculates how far the reflections have travelled from the fault. The magnitude of the fault is given by the height of the reflection at a certain distance.

Test setup:

Connect the RF measurement cable (R&S FSH-Z20) with PORT 1 of the R&S FSH.

Calling the function:

- Press the MODE key.
- Press the DISTANCE TO FAULT softkey.

The R&S FSH activates the "Distance To Fault" measurement function.

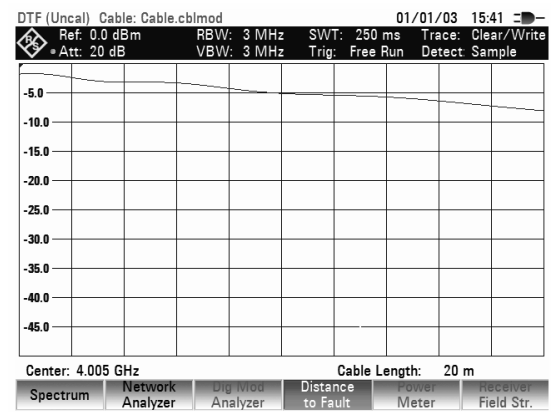

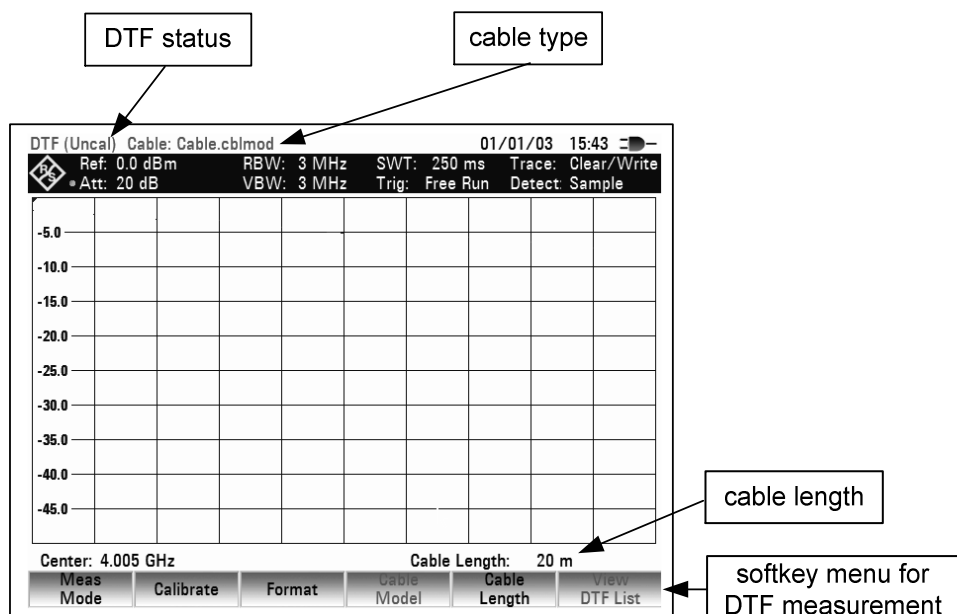

To perform distance-to-fault measurements, the R&S FSH needs to “know” the type of cable and its approximate length.

The cable type must be known to determine the speed of propagation and so the distance to any fault along the cable. The attenuation of the cable must be known to determine the size of the fault correctly. The R&S FSH automatically sets the span according to the approximate length of the cable.

Cable selection

Frequency-dependent cable models can be generated with the supplied R&S FSH4View Windows software package and loaded into the R&S FSH. The procedure is described in the R&S FSH4View manual. The R&S FSH can store up to 100 different cable types in its internal memory. The total number of storable limit lines, transducer factors and cable models is 100. If transducer factors, channel tables, limit lines or data sets are stored simultaneously, the maximum number of cable models decreases correspondingly (see "Saving and Loading Instrument Settings and Measurement Results" in this chapter).

If the distance to a cable fault is to be located precisely, it is essential to use the appropriate cable model. If not, the R&S FSH will not be able to correctly determine the distance of the fault from the measurement plane and the magnitude of the reflection at the fault.

Selecting a cable model from a predefined list:

- Press the CABLE MODEL softkey.

The R&S FSH displays the list of cable models.

- Using the rotary knob or the cursor keys, select the appropriate cable model.
- Using the softkey, activate the cable model you have selected.

The R&S FSH returns to the DTF measurement function and shows the cable used for the measurement in the upper area of the display.

Preselecting the cable length:

The R&S FSH uses the cable length to determine the optimal span for the measurement. The longer the cable under test is, the smaller the span used by the R&S FSH. The R&S FSH also calculates the cable attenuation from the selected cable model and the length setting so that the magnitude of the reflection at the fault is measured correctly. If the graphics display mode is selected for the results, the R&S FSH scales the x axis so that it represents the total length of the cable.

If the entered cable length is less than the actual cable length, the R&S FSH does not display the faults of the complete cable. A reflection at the end of the cable will not be shown. However, deliberately entering a cable length that is too short is a good way of increasing distance-to-fault accuracy for a fault that is near to the measurement plane. If the entered cable length is greater than the actual length, the measured values for lengths beyond the cable length are useless because they are caused by multiple reflections. If the length of the cable is not known precisely, it is best to enter a length that is about 20 % to 50 % greater than the best estimate of the cable length.

- Press the CABLE LENGTH softkey.

The R&S FSH opens the cable length (CABLE LENGTH) value entry box and displays the current length setting in meters or feet. The unit of length is selected by, and depends on, SETUP: INSTRUMENT SETUP: LENGTH UNIT.

- Using the numeric keys, enter the cable length in meters and terminate the entry with the ENTER key, or
- Using the rotary knob (1 m steps) or the cursor keys (10 m steps) adjust the cable length.

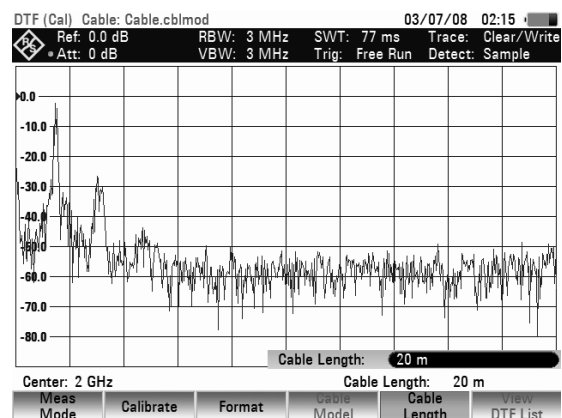

The minimum cable length is 3 meters (about 10 feet). This value is determined by the maximum frequency range of the R&S FSH. A cable length of max. 1500 m (about 5000 feet) can be entered. The maximum cable length that is suitable for measurements depends on the cable attenuation. Since the test signal must be twice routed through the cable, the signal reflected at the cable end arrives with twice the cable attenuation in attenuated form at the input of the power divider. Dynamic range decreases with increasing cable length.

If the cable attenuation exceeds 10 dB, the R&S FSH outputs a warning indicating that the cable attenuation is too high. It also indicates the maximum recommended cable length for obtaining accurate results.

Pressing CONTINUE accepts the entry.

Selecting the frequency range

In the default setting, the R&S FSH automatically selects the frequency range around the set center frequency on the basis of the cable length and cable model. The R&S FSH selects a frequency range that enables maximum length resolution.

Particularly with relatively short cables, the frequency range in which the cable is specified may then be exceeded. Therefore, the R&S FSH allows the user to define the frequency range in which the distance-to-fault measurement is carried out. However, the length resolution of the measurement is reduced by using smaller frequency ranges.

When setting the frequency range, users are advised first to set the span and then the center frequency. This prevents a message from being output stating that the desired center frequency cannot be set for the span currently being used for the distance-to-fault measurement.

- Press the SPAN key.

The R&S FSH displays the span menu for the DTF measurement. If automatic setting of the span is selected, the AUTO SPAN softkey label is highlighted in green. If the AUTO SPAN softkey is pressed, the R&S FSH sets the span for the best length resolution. If the required span is too large for the current center frequency, the R&S FSH sets the center frequency to the smallest possible frequency.

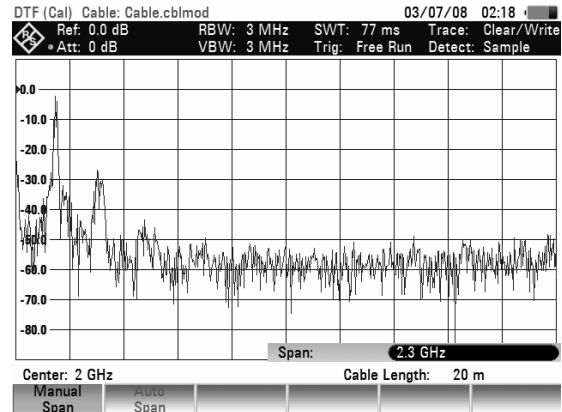

- Press the MANUAL SPAN key.
- Set the required span by using either numeric entry, the cursor keys or the rotary knob.
- Confirm the setting with the ENTER key or by again pressing the MANUAL SPAN softkey again.

The minimum span that can be set is either 1/10 of the span automatically set by the R&S FSH in the case of AUTO SPAN or 200 MHz (whichever is smaller). Spans larger than the ones set by the R&S FSH with AUTO SPAN are not allowed.

- Press the FREQ key.
- Using either the numeric keys, the cursor keys or the rotary knob, set the desired frequency.
- Confirm the entry with the ENTER key or the CENTER FREQ softkey.

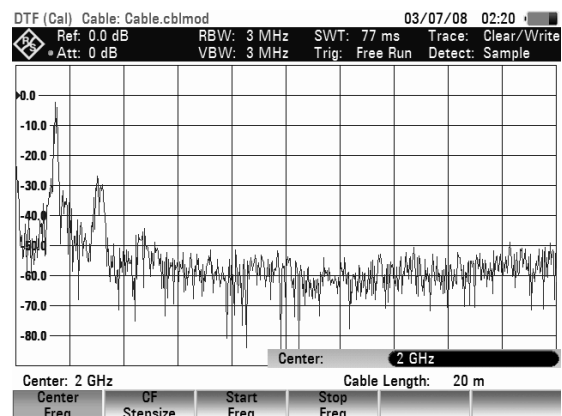

Calibrating the test setup

The test setup must be calibrated before any measurements are performed. To perform calibration, a SHORT is required at the output of the 1 m measurement cable. An OPEN can be used instead of a SHORT. However, if an OPEN is used, greater measurement uncertainties must be expected as an OPEN is not defined as precisely as a SHORT.

Note: The reference plane must be the output of the 1 m measurement cable; i.e. the measurement cable may not be dispensed with. If the output of the VSWR bridge is used as the reference plane, the DTF results are useless.

- Press the CALIBRATE softkey.
- Using the rotary knob or the cursor keys, select DTF ONLY from the menu and confirm with the CALIBRATE softkey or the ENTER key

The R&S FSH opens a text window which prompts the user to terminate the measurement cable with a SHORT.

- Firmly screw the SHORT to the output end of the measurement cable.
- Press the CONTINUE softkey to start the SHORT calibration.
- Calibration can be aborted by pressing CANCEL.

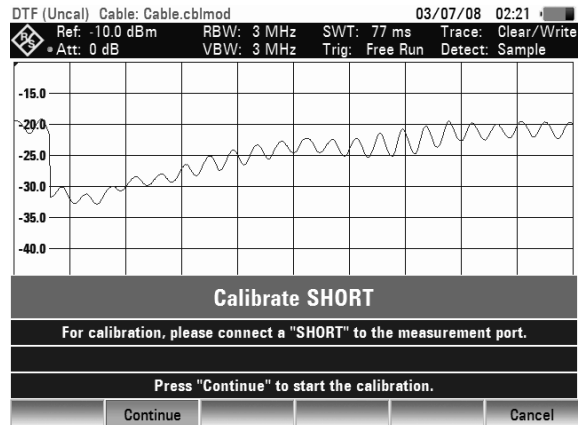

When calibration is done, the R&S FSH displays DTF (CAL) in the upper area of the screen.

The trace displays cable reflections versus distance from the measurement plane.

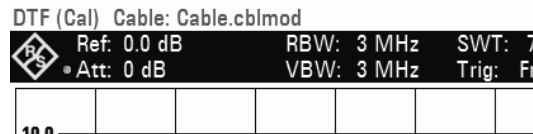

Note on Calibration:

Calibration is performed over the entire R&S FSH frequency range. This eliminates the need for recalibration when a different cable length is selected. The calibration data are saved in the R&S FSH's internal memory so that calibration remains effective when switchover is made to another operating mode or the instrument is switched off. As a precondition for calibration to remain valid, however, the instrument temperature must not change by more than 5 °C after calibration.

- Unscrew the SHORT from the measurement cable.
- Screw the cable under test to the measurement cable.

The R&S FSH displays the reflections produced in the cable under test.

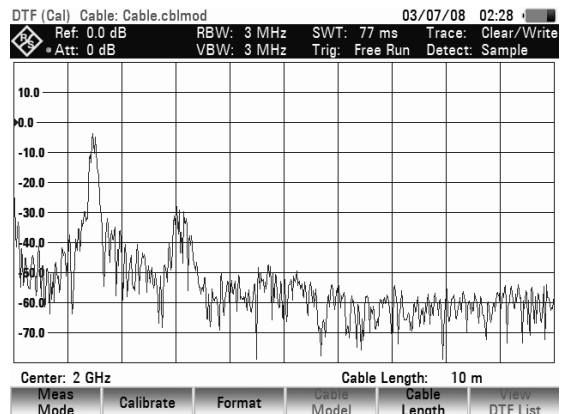

To select the display unit:

- Press the AMPT key.
- Press the RANGE softkey.

The R&S FSH will open the menu for selecting the display ranges. The available units depend on the selected measurement: return loss in dB, linear in %, standing wave ration (VSWR), reflection coefficient (ROH) and reflection coefficient (mROH). Select the display unit you want by using the cursor keys or the rotary knob.

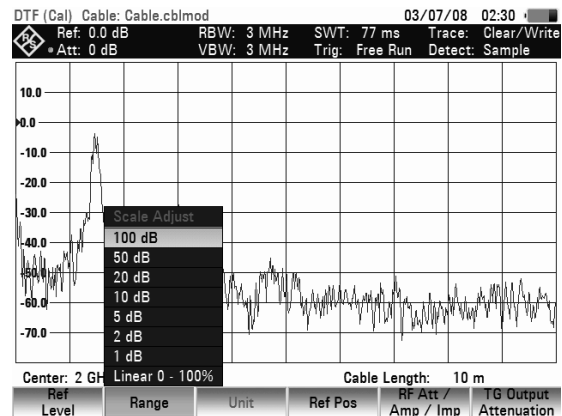

The R&S FSH can also list any cable faults. It displays the return loss and distance from the measurement plane of all reflections that exceed a settable threshold.

- Press the VIEW DTF LIST softkey in the Distance to Fault menu.

The R&S FSH opens the threshold value entry box and also displays the threshold as a horizontal line across the measurement diagram.

- Set the threshold using the cursor keys (5 dB steps), the rotary knob (1 dB steps) or the number keys.

- Press the ENTER key or the VIEW DTF LIST softkey again.

The R&S FSH displays a table listing all the reflections that are above the threshold sorted according to distance from the measurement plane.

- To change the threshold for the table display, press the THRESHOLD softkey and enter the new value.
- To close the list and to return to the graphics display mode, press the EXIT softkey.

Measurements using the power sensor

For even more accurate power measurements, the R&S FSH can be used with the Power Sensors R&S FSH-Z1 and R&S FSH-Z18. Their frequency ranges are 10 MHz to 8 GHz and 10 MHz to 18 GHz, respectively. This means that both sine signals and modulated signals can be measured precisely over a large dynamic range.

Connecting the power sensor

The Power Sensors R&S FSH-Z1 and -Z18 are controlled and powered via a special interface. Connect the power sensor cable to the R&S FSH's power sensor connector and screw into position. The DUT is connected to the N-connector on the power sensor.

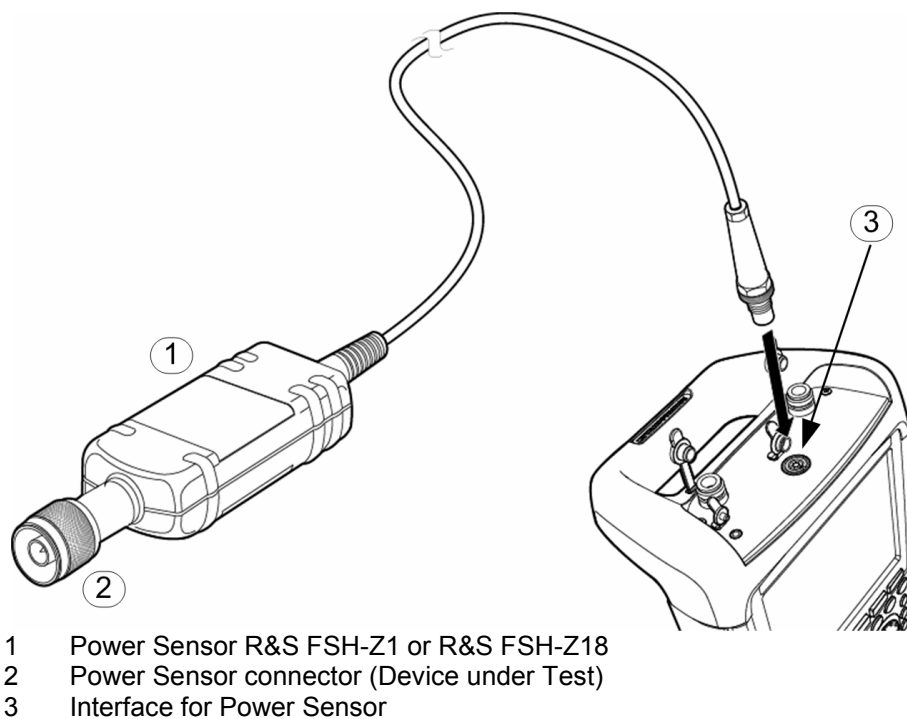

NOTICE

The continuous power applied to the power sensor's input must not exceed 400 mW (26 dBm). Short ($\leq 10 \mu\text{s}$) power peaks up to 1 W (30 dBm) are however permissible. Higher input powers may destroy the sensor. An attenuator pad must be used to ensure that the maximum permissible power for the sensor is never exceeded when measurements are made on high-power transmitters.

Measurement:

The POWER SENSOR function turns the R&S FSH into a wideband power meter. Then, it always measures the power of the whole signal from 10 MHz to 8 GHz or from 10 MHz to 18 GHz, in most cases the signal shape having no effect on the measurement.

Operating sequence:

- Press the MODE key.
- Press the POWER METER softkey.

The Power Meter submenu opens.

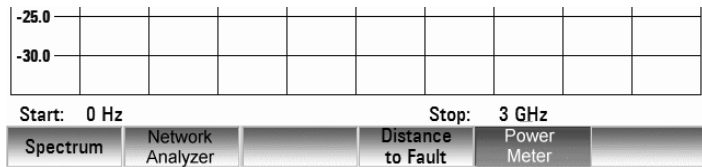

The R&S FSH opens the screen for power measurements. If no power sensor is connected, no measured value is displayed. If a power sensor is connected, the R&S FSH sets up a connection via its interface and after a few seconds displays the measured power.

In the event of incorrect operation or sensor malfunction, the R&S FSH outputs the following error messages:

Message	Cause	Remedy
Error in zeroing: signal at sensor	A signal was present at the power sensor when zeroing was performed.	Unscrew the power sensor from the device under test and repeat zeroing.
Warning: Input overloaded	The power at the input of the power sensor exceeds the permitted power (23 dBm = 200 mW).	Reduce the power at the sensor input.
Power sensor hardware error	Communication error between the R&S FSH and the power sensor.	Unscrew the sensor from the R&S FSH and check the connectors. If the problem persists, contact a Rohde & Schwarz service center.
Power sensor error	The power sensor signals an error to the R&S FSH.	Contact a Rohde & Schwarz service center.
Unknown power sensor model connected	The R&S FSH cannot identify the device connected to its POWER SENSOR connector.	

Screen layout for power-sensor measurements:

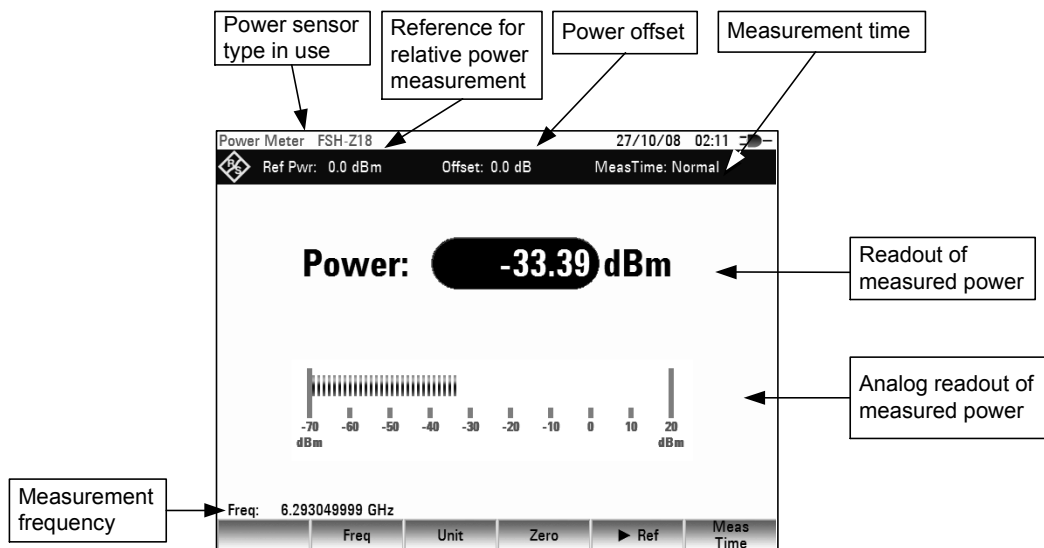

The power sensor has a memory containing frequency-dependent correction values. This means that the highest accuracy is reached for signals whose frequency is known. If the R&S FSH switches over to the power measurement mode from another operating mode, it uses the center frequency as the frequency for the power sensor.

If you want to perform measurements on another known signal, the power sensor can be “told” what the center frequency is via the frequency entry mode (FREQ softkey).

- Press the FREQ softkey.

The frequency value entry box opens.

- Using the number keys, enter the frequency you want and confirm the entry with the ENTER key or by pressing the FREQ softkey again.

The R&S FSH transfers the new frequency to the power sensor which then corrects the measured power readings.

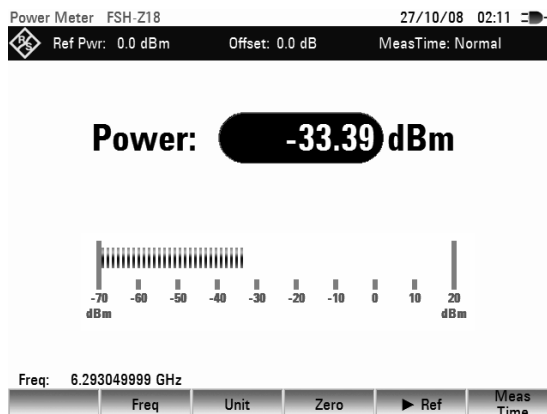

Zeroing the power sensor

Offset voltages and currents have most effect on the power readout when low powers are being measured. Zeroing is used to compensate for these offsets. The power sensor zeroes itself automatically when instructed to do so by the user. No power may be applied when zeroing is being performed, as the power sensor cannot distinguish between external powers and internal offsets.

- Press the ZERO softkey.

The R&S FSH outputs a message to tell the user not to apply any signals to the power sensor when zeroing is being performed.

- Disconnect the power sensor from any signal sources.
- Start zeroing by pressing the CONTINUE softkey.

Press CANCEL to abort zeroing, if, for example, a signal source cannot be disconnected.

The R&S FSH immediately starts power sensor zeroing. While zeroing is in progress, the R&S FSH outputs the message “Zeroing power sensor, please wait..”.

When zeroing is over, the R&S FSH outputs the message "Power sensor zero OK" and switches back to the softkey menu for the power sensor.

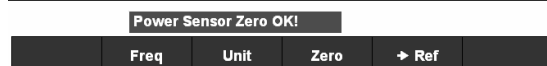
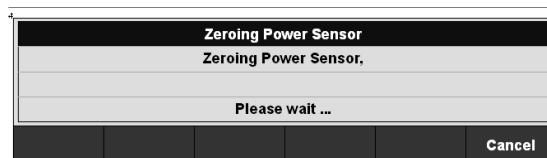
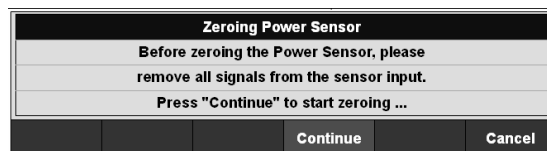

Selecting the unit for the power readout

The R&S FSH can display measured power in relative units (dBm) or in absolute units in Watts (W, mW, μ W, nW and pW). A reference level in dB is also provided by the R&S FSH.

- Press the UNIT softkey.

The units submenu then opens.

- Using the rotary knob or the cursor keys select the appropriate unit.
- Confirm with the ENTER key or the UNIT softkey.

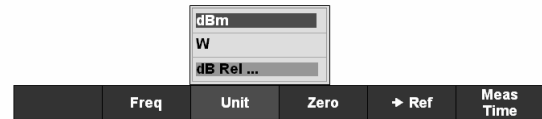

If the unit dB REL... has been selected, the reference level value entry box opens.

- Enter the reference level (REFERENCE) with the number keys and terminate entry with the appropriate unit or change the reference level using the rotary knob or cursor keys.

The current level reading can be made the reference level by just pressing the ->REF softkey.

- Press the ->REF softkey.

The R&S FSH sets the current measured level as the reference level and from then on displays the measured level relative to the reference level in dB. The unit (UNIT) is automatically set to dB REL... .

The reference level is shown in the top left-hand corner of the screen.

In the REFERENCE value entry box, the reference level can be adjusted with the rotary knob or the cursor keys or corrected by making a numeric entry.

- Confirm the reference level with the ENTER key or by pressing the ->REF softkey.

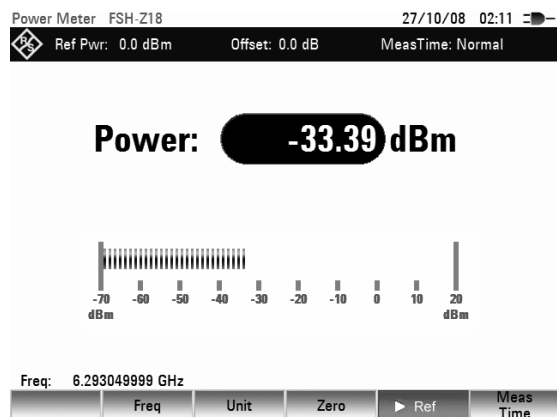

Setting the averaging time

The averaging time determines how long the signal will be measured for. The longer the averaging time, the more stable the display – particularly if signals are at the lower end of the measurement range or are noisy. The R&S FSH has three times for power measurements: short, normal and long.

Stationary sine signals with a high level (> -40 dBm) require only a short measurement time to produce a stable, accurate result. In this case, the FAST operating mode is recommended to obtain a high repetition rate for the measurement. When the NORMAL setting is selected, the stability of the display is increased for signals with low levels or for modulated signals. The LONG mode is recommended for signals at the lower end of the measurement range (< -50 dBm to < -60 dBm). The R&S FSH-Z1 averages out the noise most effectively and the effect of noise on the measurement is minimal.

- Press the MEAS TIME softkey.

- Using the rotary knob or the cursor keys select the measurement time you want from the menu (i.e. SHORT, NORMAL or LONG).
- Confirm your selection with the ENTER key or by pressing the TIME softkey again.

Taking additional loss or gain into account

At high powers which cause the R&S FSH-Z1's maximum input level to be exceeded or at very low levels which are below the instrument's minimum sensitivity, the R&S FSH can take additional loss or gain introduced between the DUT and the power sensor into account. These are defined in terms of an offset in dB relative to the measured level. A positive offset corresponds to a loss and a negative offset to a gain.

- Press the AMPT key.
- Press the REF OFFSET softkey.

Ref Level	Range / Ref Pos	Unit	Ref Offset	RF Att / Amp / Imp	Transducer
-----------	-----------------	------	------------	--------------------	------------

The value entry box for the reference offset opens.

- Using the rotary knob, the cursor keys or the number keys enter the offset you want and confirm the entry with the ENTER key.

The offset is displayed centrally at the top of the screen and is taken into account in the power or level display.

Measuring forward and reflected power

The Directional Power Sensors R&S FSH-Z14 and R&S FSH-Z44 are connected between the source and the load and measure the power flow in both directions, i.e. from the source to the load (forward power) and from the load to the source (reflected power). The ratio of forward to reflected power indicates how well a load is matched to the source. This ratio is referred to as return loss or voltage standing wave ratio (VSWR).

The Directional Power Sensors R&S FSH-Z14 and R&S FSH-Z44 are of non-symmetrical design, i.e. they must be connected such that the forward arrow (1 → 2) on the sensor points to the load (corresponding to the direction of forward power).

The directional power sensors are controlled and powered via a special serial interface. The sensor cable is to be connected and screwed to the POWER SENSOR connector on the R&S FSH. The sensor is to be connected between the source and the load.

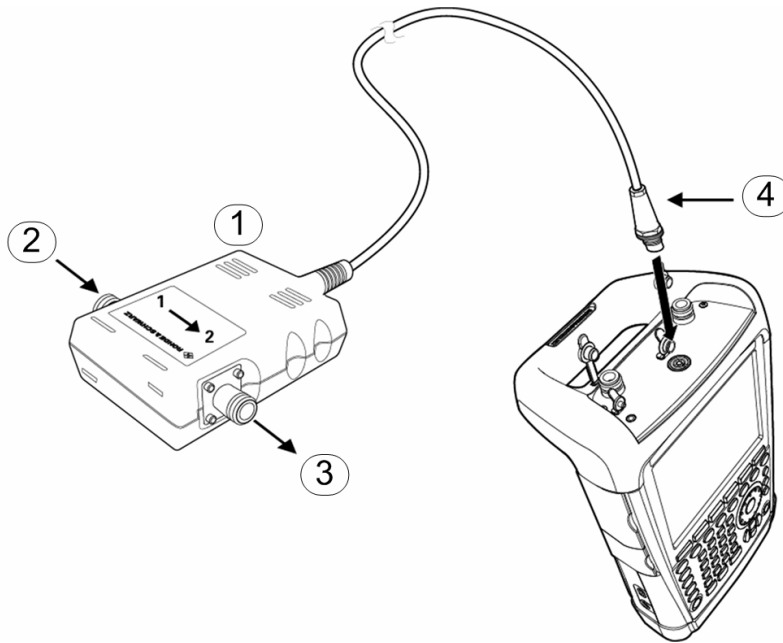

- 1 Directional Power Sensor R&S FSH-Z44
- 2 Source
- 3 Load
- 4 Power sensor socket

When measuring high powers, strictly observe the following instructions to prevent damage to the sensor or hazard to persons:

CAUTION



Danger of skin burns or damage to the instrument

- Never exceed the permissible continuous power.
- See diagram on the rear of the sensor for the permissible continuous power.
- Turn off the RF power to connect the sensor.
- Screw the RF connectors tightly.

Operating sequence:

- Press the MODE key.
- Press the POWER METER softkey.

The power meter submenu opens.

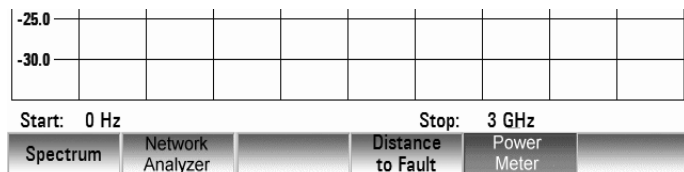

The R&S FSH opens the screen for power measurements. If no power sensor is connected, it does not display any measured value and outputs POWER SENSOR (UNKNOWN) in the status field. If a power sensor is connected, the R&S FSH sets up a connection via its interface, displays first the message POWER SENSOR (DETECTING) and then the message POWER SENSOR (BOOTING) in the status field and, after a few seconds, displays the type of the sensor connected (R&S FSH-Z44) as well as the measured power.

In the event of incorrect operation or sensor malfunction, the R&S FSH outputs the following error messages:

Message	Cause	Remedy
Error in zeroing: signal at sensor	A signal was present at the power sensor when zeroing was performed.	Unscrew the power sensor from the device under test and repeat zeroing.
Warning: input overloaded	The power at the input of the power sensor exceeds the permissible power.	Reduce the power at the sensor input.
Hardware error	Communication error between the R&S FSH and the power sensor.	Unscrew the sensor from the R&S FSH and check the connectors. If the problem persists, contact a Rohde & Schwarz service center.
Power sensor error	The power sensor signals an error to the R&S FSH.	Contact a Rohde & Schwarz service center.

Screen layout for measurements with Directional Power Sensors R&S FSH-Z14/-Z44:

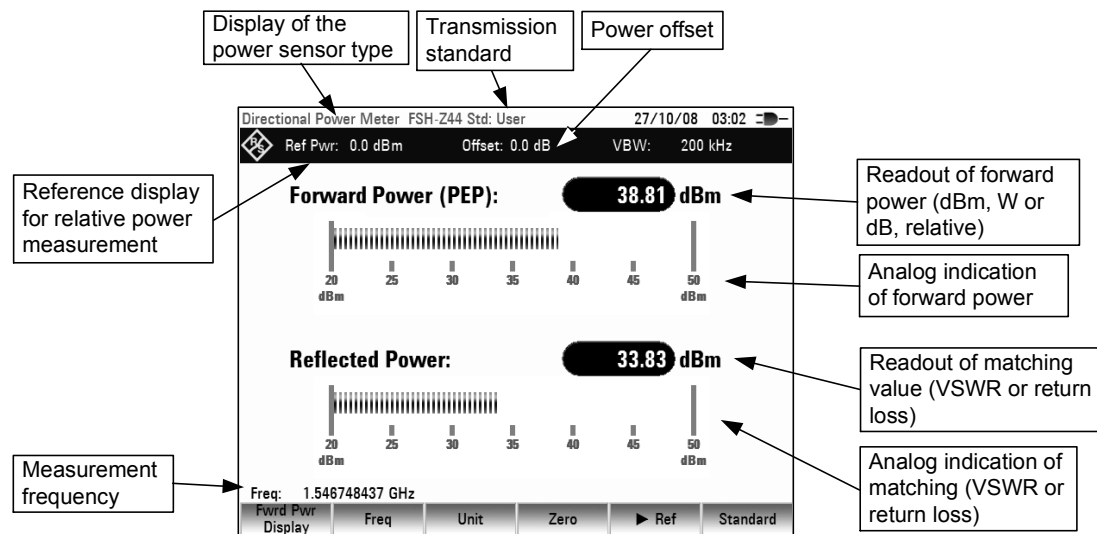

The power sensors contain frequency-dependent correction values. This means that the highest accuracy is reached for signals whose frequency is known. When the R&S FSH switches to the power measurement mode from another operating mode, it transfers its current center frequency to the power sensor.

If a signal at another frequency is to be measured, the new center frequency can be transferred to the power sensor by entering the frequency (FREQ softkey).

- Press the FREQ softkey.

The frequency value entry box opens.

- Using the number keys, enter the frequency you want and confirm the entry with the ENTER key or by pressing the FREQ softkey again.

The R&S FSH transfers the new frequency to the power sensor which corrects the measured power values accordingly.

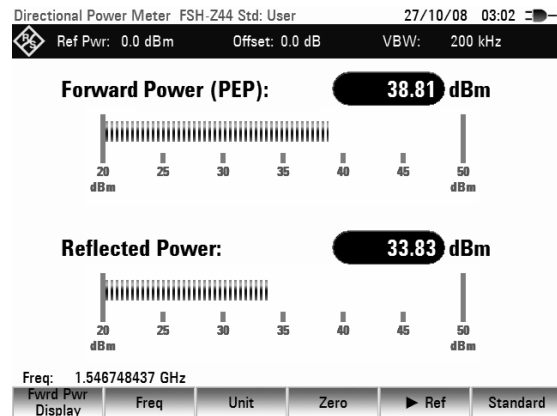

Zeroing the power sensor

Offset voltages and currents have the greatest effect on the power readout when low powers are being measured. Zeroing is used to compensate for these offsets. The power sensor automatically performs zeroing when the corresponding function is activated by the user. No power must be applied to the sensor while zeroing is being performed, since the sensor cannot distinguish between external powers and internal offsets.

- Press the ZERO softkey.

The R&S FSH outputs a message to inform the user that no signal should be present at the power sensor input while zeroing is being performed.

- Disconnect the power sensor from any signal sources.
- Start zeroing by pressing CONTINUE.

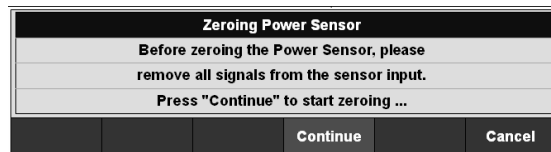

Zeroing can be aborted before it is started by pressing CANCEL, for example if a signal source cannot be disconnected.

The R&S FSH immediately starts zeroing the power sensor after CONTINUE is pressed. While zeroing is in progress, the message "Zeroing power sensor, please wait..." is displayed on the R&S FSH.

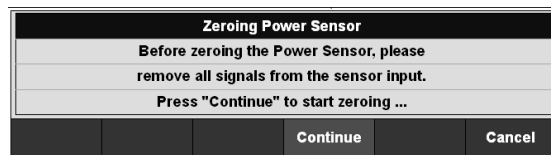

When zeroing is completed, the R&S FSH outputs the message "Power Sensor Zero OK" and switches back to the softkey menu for the power sensor.



Setting the power measurement weighting

For forward power display, the R&S FSH provides both average power and peak envelope power. Use the FWRD PWR DISPLAY softkey in the Power Sensor menu to switch between the two.

- Press the FWRD PWR DISPLAY softkey.
- Select PEAK ENVELOPE from the menu using the rotary knob or the cursor keys.
- Confirm your selection with the ENTER key or by pressing the FWRD PWR DISPLAY softkey.

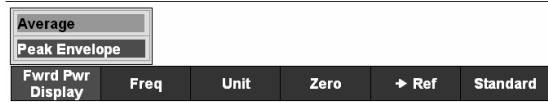

The currently set weighting mode is highlighted in green.

- Select the desired weighting mode using the rotary knob or the cursor keys.
- Confirm your choice with the ENTER key or the FWRD POWER DISPLAY softkey.

The R&S FSH displays the set weighting under the heading forward power on the screen:

Forward power (AVG) = average power
 Forward power (PEP) = peak envelope power

Selecting the unit for the power readout

The R&S FSH displays the measured forward power as a logarithmic level value in dBm (relative value) or as a linear value in W or mW (absolute value). Moreover, a reference level can be defined relative to which the R&S FSH indicates the level difference in dB. Load matching is indicated as return loss in dB or as voltage standing wave ratio (VSWR). In addition, the absolutely reflected power can be displayed in W, or the reflected level in dBm.

- Press the UNIT softkey.

The menu for selecting the units for forward power and reflected power display opens.

- Using the rotary knob or the cursor keys, select the unit for the power readout.

For the forward power, the following units can be selected:

dBm
 W
 dB REL

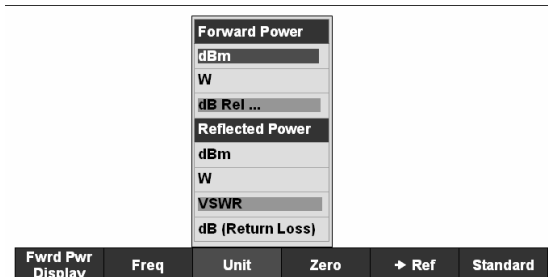

For the reflected power or the reflection, the following units can be selected:

dBm
 W
 VSWR
 dB (return loss)

- Confirm the parameter with the ENTER key or the FWRD POWER DISPLAY softkey.

When the dB REL... unit is selected, an entry box for the reference level opens.

- Enter the reference level (REFERENCE) using the number keys and terminate the entry with the appropriate unit, or change the reference level using the rotary knob or the cursor keys.

The current level reading can be defined as the reference level simply by pressing the ->REF softkey.

- Press the ->REF softkey.

The R&S FSH accepts the currently measured level as the reference level and displays the measured level difference relative to the reference level in dB. The unit (UNIT) is automatically set to dB REL... .

The reference level is displayed in the upper left corner of the screen (in this case: Ref: -4.8 dBm).

The reference level can be adjusted in the REFERENCE entry box by means of the rotary knob, the cursor keys or the number keys.

- Confirm the reference level with the ENTER key or the ->REF softkey.
- To switch off the relative measurement to absolute values, press the FWRD PWR DISPLAY softkey.
- Select the Forward Power... parameter.
- Select dBm or Watt for forward power indication.

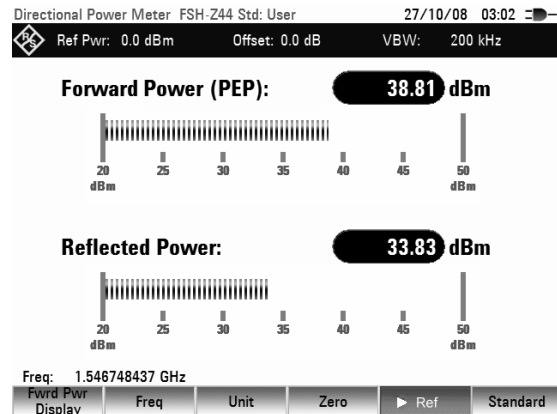

To ensure that true results are output when measuring modulated signals, the R&S FSH offers the possibility of taking correction values into account for a number of common transmission standards.

- Press the STANDARD softkey.

A menu with the selectable standards opens.

- Select the desired standard using the rotary knob or the cursor keys.
- Confirm with the ENTER key or by pressing the STANDARD softkey again.

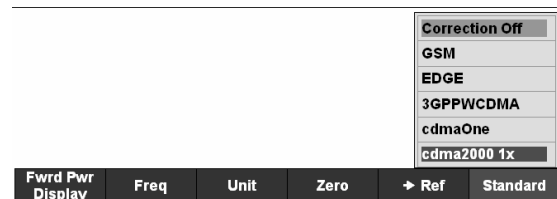

The selected standard is displayed in the upper right corner of the screen.

Taking additional attenuation into account

When the directional power sensor is connected to a test point not directly but via a cable, the influence of cable attenuation can be taken into account. For this purpose, the cable attenuation for the measurement frequency in question is to be entered, i.e. as a positive dB value if the power and matching are to be measured at the source and the cable is connected between the source and the power sensor, and as a negative dB value if the power and matching are to be measured at the load and the cable is connected between the load and the power sensor. The directional power sensor then corrects the power and matching values to produce the results that would have been obtained if it had been directly connected to the test point.

- Press the AMPT key.
- Press the REF OFFSET softkey.

Ref Level	Range / Ref Pos	Unit	Ref Offset	RF Att / Amp / Imp	Transducer
-----------	-----------------	------	------------	--------------------	------------

The value entry box for the reference offset opens.

- Enter the desired offset using the rotary knob, the cursor keys or the number keys and confirm the entry with the ENTER key.

The selected offset is displayed in the middle at the top of the screen and is taken into account in the power (level) and matching results.

If high powers are applied that exceed the maximum input level of the R&S FSH-Z14 or R&S FSH-Z44, a directional coupler or an attenuator has to be connected ahead of the power sensor. In such cases, the coupling attenuation of the directional coupler or the attenuation value of the attenuator are to be entered as positive dB values (see above) into the R&S FSH to ensure true measured power readout. In both cases, a termination or an attenuator of sufficient power-handling capacity has to be connected to the power sensor at the load end. The matching readout is irrelevant in such case since it is likewise corrected by taking into account the attenuation value of the termination or attenuator (see measurement via cable).

Measuring with Transducer Factors

The frequency-dependent transducer factor of transducers and antennas can be directly considered in the measurement result. A transducer factor consists of a numeric values and a unit. The R&S FSH corrects the level values of the trace by the values of the transducer. At the same time, the unit of the transducer is assigned to the level axis. When field-strength measurements are performed with the aid of antennas, for instance, the electrical field strength is directly indicated in dB μ V/m on the R&S FSH. A transducer factor can also be used to correct a frequency-dependent attenuation, e.g. of a cable between DUT and RF input of the R&S FSH.

More than 100 transducer factors with 60 reference values each can be stored internally. The maximum number of transducer factors may be reduced if cable models, channel tables, limit lines, or data sets are stored simultaneously (see "Saving and Loading Instrument Settings and Measurement Results" in this chapter).

Interpolation between the values is performed with the aid of a modified spline algorithm. Even if only relatively few values such as maxima, minima and turning points are available, this algorithm can easily simulate the correction factors of common transducers. Two transducers can be switched on at a time. The second transducer must be assigned the unit dB. The R&S FSH adds the two transducers to a total transducer.

Transducer factors are defined with the aid of control software FSH4View. They are transferred from the PC to the instrument via LAN or the USB interface.

Units supported for transducer factors:

- dB
- dB μ V/m
- dB μ A/m
- W/m²

The unit dB does not change the unit set on the R&S FSH. It can be used, for instance, to compensate for frequency-dependent loss and gain at the input of the R&S FSH. The units dB μ V/m and dB μ A/m convert the output power of an antenna into electric or magnetic field strength. The unit W/m² is used to calculate and display the power flux density.

For example, to compensate for the cable loss between the transducer and the RF input, the R&S FSH can use two transducers at the same time. One of them must have the unit dB, however, i.e. it must correspond to one loss or gain value.

Operating sequence:

- Press the AMPT key.
- Press the TRANSDUCER softkey.

The softkey menu for operation of transducer factors is displayed on the screen.

N.B: Transducer factors are not available for measurements with the tracking generator or the Power Sensors. The TRANSDUCER softkey is therefore interactive.

Two transducer factors can be selected with the menu entries SELECT PRIMARY TRANSDUCER and SELECT SECONDARY TRANSDUCER. [] PRIMARY TRANSDUCER and [] SECONDARY TRANSDUCER are used to switch the selected transducer factors on and off.

- Press the SELECT PRIMARY TRANSDUCER softkey.

The R&S FSH displays a list of transducer factors available in the unit. The cursor is on the active transducer factor (line highlighted). If no transducer is active, the cursor is on the first item in the list.

- Select the desired transducer factor with the rotary knob or the cursor keys and switch it on with the SELECT softkey.

Note: With an inserted SD card, switch between internal memory and memory card by pressing the INTERNAL/SD-CARD softkey.

- Quit the transducer menu with the EXIT softkey.

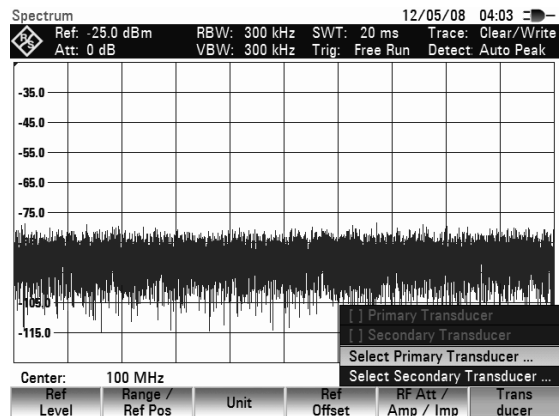

Stat	Name	Size	Date	Time
Public \.				
RS HFH-Z2.pritrd		1 kB	12/05/2008	03:51
RF Cable 3m.pritrd		1 kB	12/05/2008	03:49

Free: 27 MB

view Edit/New Select Sort/Show Internal/SD-Card Exit

If a transducer is switched on, the R&S FSH shows the selected transducer after the AMPT key is pressed.

The complete name of the selected transducer is also displayed in the status line (press the STATUS key and scroll downward in the list), or in the list of transducer factors (entry highlighted in red).

The example (Fig. right) shows the transducer factor of the R&S HL223 antenna, which is defined as between 200 MHz and 1300 MHz. The R&S FSH therefore displays the noise in this frequency range as a function of frequency incremented by the transducer factor. Outside the transducer range, the R&S FSH sets the transducer factor at zero, i.e. measurements in this range do not yield conclusive results.

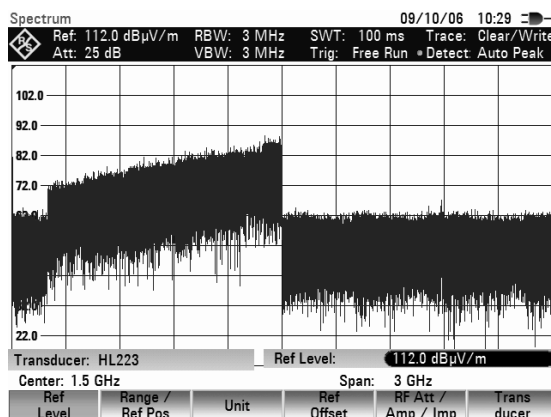

A second transducer factor can be selected with the SELECT SECONDARY TRANSDUCER softkey, which is then added to the first, as soon as the menu entry [X] SELECT SECONDARY TRANSDUCER is marked with an X. The unit of the second transducer factor must always be the relative unit dB as otherwise an addition would not be useful. When SELECT SECONDARY TRANSDUCER is selected, the R&S FSH offers only the transducer factors stored in the instrument with dB as the unit.

Unit for measurements with transducers

If the unit of the transducer is dB, the units dBm, dBmV or dBμV remain unchanged. The linear units Volt and Watt are not permissible. They are deactivated in the units menu.

If the unit of the transducer is dBμV/m or dBμA/m, this unit is also used for the R&S FSH level display. This means that both the level axis of the diagram and the level at the marker position are assigned the unit of the transducer. If dBμV/m is selected as the transducer unit, switchover to absolute level indication in V/m is possible.

Switchover to V/m level indication:

- Press the AMPT key.
- Press the UNIT softkey.
- In the UNIT menu, select V by means of the rotary knob or the cursor keys and confirm with the ENTER key or by pressing the UNIT softkey again.

If a transducer with the unit dBμA/m is switched on, no other unit can be selected in the AMPT menu. Level indication is entirely in dBμA/m.

Reference level settings for measurements with transducers

The transducer shifts the trace by its value as a function of frequency. Positive transducer values increase the level, negative values reduce it. To ensure that the trace is always within the diagram, the R&S FSH adjusts the reference level accordingly. The reference level is shifted by the maximum transducer value in the positive or negative direction.

Frequency range of transducer

If the set frequency range is wider than the span in which a transducer is defined, the R&S FSH assumes the transducer values outside the defined range to be zero.

Data sets containing transducer factors

The R&S FSH stores data sets together with any transducer factors that may have been active for the measurement in question. When such a data set is recalled, the associated transducer factor(s) are switched on as well. Transducer factors recalled as part of a data set do however not appear in the list of transducer factors.

Saving and Loading Instrument Settings and Measurement Results

The R&S FSH's settings and measurement results can be saved to the internal memory and recalled at a later date. Using the **R&S FSH4View** software package, these data sets can also be saved to a PC from the R&S FSH or downloaded onto the R&S FSH from a PC.

Results and settings, including the measurement function, are always saved en bloc so that when the results are recalled the measurement context is clear. The R&S FSH can store at minimum 100 data sets which are assigned a unique name.

Data sets for scalar transmission and reflection measurements can be stored along with their calibration data. When such data sets are recalled, therefore, measurements can be performed without prior calibration. Saving a data set with calibration data, however, requires twice as much memory space as without it, i.e. a data set with calibration data takes up the space required for two data sets without calibration data. This reduces the maximum number of data sets that can be stored by the number of data sets stored with calibration data.

Storage of calibration data can be selected in the SETUP menu (see Chapter 2, section "Saving Calibration Data").

If cable models, channel tables, limit lines or transducer factors are stored simultaneously, the maximum number of data sets will be reduced. In addition, the size of the data sets can vary as a function of the selected measurement function. A complete data set uses approx 100 kB of memory.

The R&S FSH provides a total internal storage space of approx 20 MB. In addition data sets, cable models, channel tables, limit lines and transducer factors can be stored on a SD card. Thus the amount of data sets that can be stored depends only on the size of the SD card in use.

➤ Press the SAVE key.

The R&S FSH opens the SAVE / PRINT menu where the functions for saving, clearing and loading data sets are displayed for selection.

A screenshot can also be output to a printer.

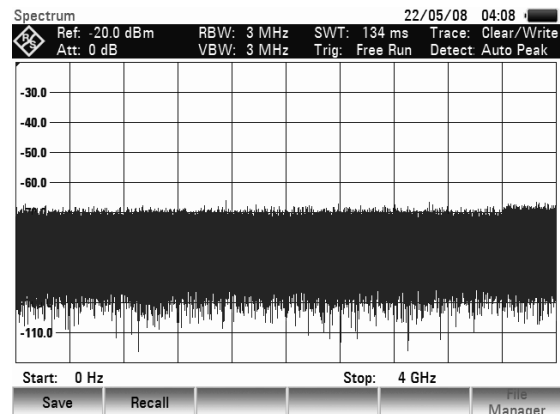

Saving results

- Press the SAVE softkey.

The R&S FSH opens a text box and prompts the user to enter a name for the data set.

The **Name** entry box, which is highlighted in red, also suggests a name for the data set (DATASET.003) which can be accepted by pressing the ENTER key.

For the sake of simplicity, the R&S FSH also saves the data set when the SAVE softkey under the suggested name is pressed twice.

The softkey INTERNAL / SD CARD selects either the internal memory of the FSH or the SD card as the storage medium for the data set.

The remaining *free memory* size (**Free xx MB**) is also displayed in the text box. Since the data sets can be different in size, the remaining storage space is indicated as a percentage value.



The data set name comprises a text section and a numeric extension, which are separated by a full stop. The data set name suggested by the R&S FSH is derived from the name of the data set last stored, the numeric extension being incremented by 1 in each case.

This means that consecutive data set names can be assigned by simply saving with SAVE or ENTER.

The names of the data sets already stored can be displayed one after the other using the BACK key. This allows, for example, to store new results under the name of a previous data set (for example Antenna.000), but with a new extension. The R&S FSH displays the old name together with the first unassigned extension, e.g. Antenna.001. No new name has to be entered.

Entering a data set name

A new name can be entered with the numeric keypad. The letter assignment for the keypad is the same as that for a mobile phone

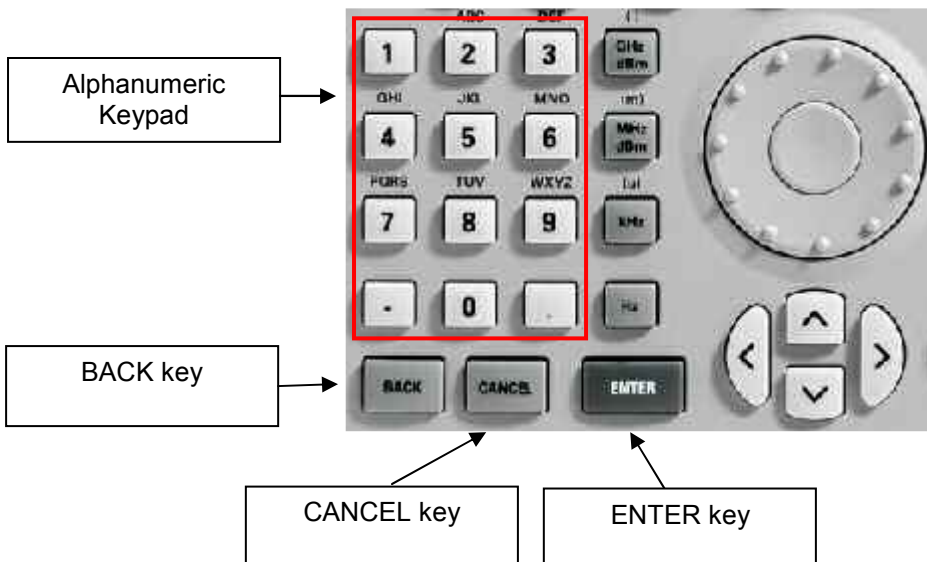

If the R&S FSH is expecting a letter entry, it automatically assigns the letters above the keys to the keys in the alphanumeric keypad. The keys have a multiple assignment. Enter the letter you want by pressing the key in question the appropriate number of times.

- Using the alphanumeric keypad enter a name for the data set and terminate the entry with the ENTER key.

The data set is saved to the R&S FSH's internal memory under the name that has been given.

Loading measurement results

Previously saved measurement results and settings can be recalled with the R&S FSH's recall function.

- Press the RECALL softkey.

The R&S FSH opens a list of all the data sets that have been saved.

The red selection bar indicates the last data set to have been saved.

Using the cursor keys, you can position the selection bar at the top or bottom of the page. This means fast scrolling if many data sets have been saved in the R&S FSH's memory.

The softkey INTERNAL / SD CARD selects either the internal memory of the FSH or the SD card as the storage medium for the data set.

You can quit the menu by pressing the EXIT softkey. The R&S FSH returns to its previous settings.

Recall Dataset		09/10/06 08:42		
Stat	Name	Size	Date	Time
▶	\Public\			
	Dataset000.set	40 kB	28/04/2006	11:48
	Dataset001.set	18 kB	22/05/2006	21:25
	Dataset002.set	18 kB	22/05/2006	21:56
	Dataset003.set	75 kB	09/10/2006	05:54
	Dataset004.set	75 kB	09/10/2006	05:55
	Dataset005.set	75 kB	09/10/2006	06:01

Free: 27 MB

View Recall Sort/Show Internal/SD Card Exit

- Using the rotary knob or the cursor keys select a data set.
- Load the data set by pressing the RECALL softkey.

Measurements

How a spectrum analyzer operates

Basically, an RF signal can either be analyzed in the time domain or in the frequency domain.

In the time domain, how the signal varies with time can be observed on an oscilloscope, for example. In the frequency domain, a spectrum analyzer can be used to display the frequency components of a signal.

Both modes are essentially equivalent because applying the Fourier transform to any signal converts it into its spectral components. However, depending on the signal characteristic to be measured, one method is usually more appropriate than the other. Just by glancing at an oscilloscope, it is possible to tell whether a measurement signal is a sine signal, a squarewave with a certain on/off ratio or a sawtooth. However, it is not at all obvious what the harmonic content of the signal is or if low-level signals are superimposed. This is easy to see with a spectrum analyzer.

The following Fig. shows the theoretical basis of the two measurement techniques. In the time domain, an oscilloscope is showing a section of a signal which is approximately a squarewave. The same signal viewed with a spectrum analyzer shows a line spectrum, i.e. the fundamental and harmonics.

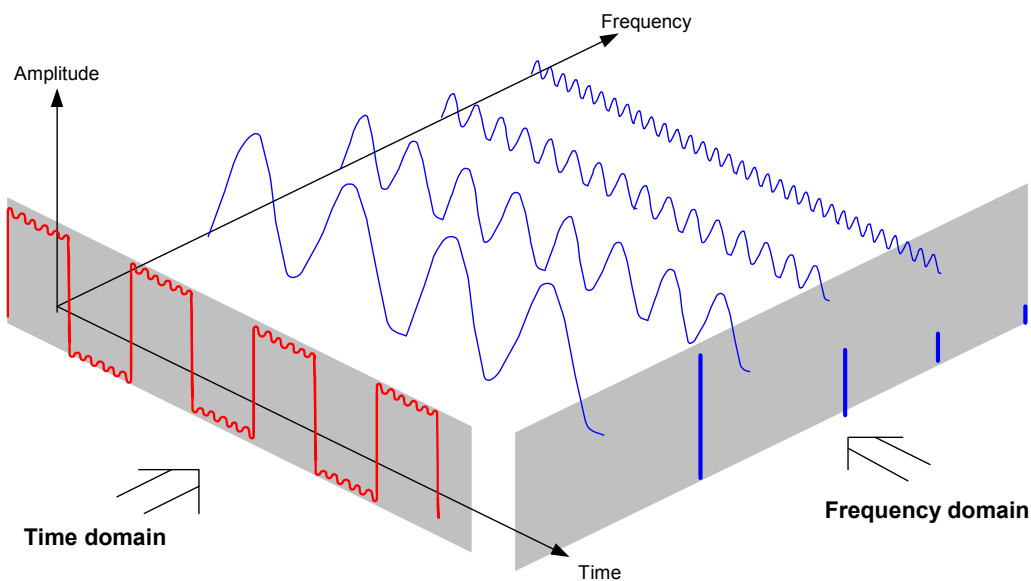

The periodic squarewave in the time domain can be Fourier transformed to the frequency domain. In the case of a squarewave there is a fundamental (= frequency of the squarewave) and its odd harmonics. Using a narrow bandpass filter, the spectrum analyzer makes measurements in the frequency domain. Only at frequencies where there is a signal is there a reading which gives the amplitude of the frequency component.

The block diagram below shows how a spectrum analyzer works.

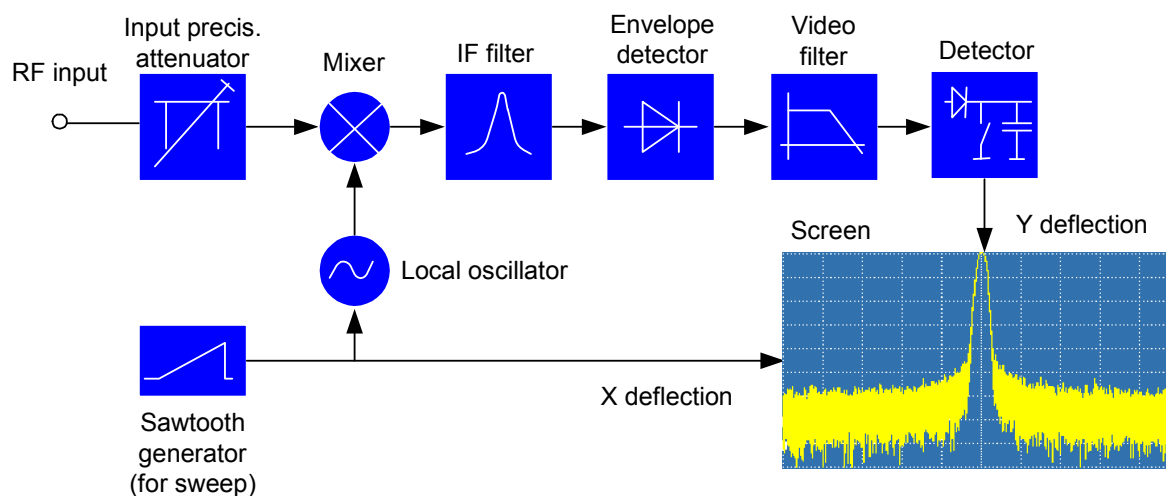

The precision attenuator at the input of the spectrum analyzer adjusts the level of the measurement signal to the level range that the mixer can handle without overdriving it. The precision attenuator at the input of the R&S FSH is adjustable in 10 dB steps from 0 dB to 30 dB and is directly coupled to the reference level setting.

The mixer converts the RF input signal to a fixed IF. Conversion is usually performed in several stages to an IF for which good narrowband IF filters are available. The R&S FSH4 has three mixing stages with the IFs 4856 MHz, 831.4 MHz and 21.4 MHz. Up to 3.6 GHz, the R&S FSH8 uses the same IFs as the R&S FSH4. Between 3.6 GHz and 8 GHz, it uses a first IF at 8856 MHz, which it converts to the second IF of 831.4 MHz with the aid of the second local oscillator. As of the second IF, the signal path for the two ranges is identical.

A local oscillator that can be tuned from 4.8 GHz to 8.4 GHz is used in the R&S FSH4 for conversion to the first IF so that a certain input frequency is converted to the first IF. The further conversions are performed by single-frequency oscillators.

The frequency of the local oscillator determines the input frequency at which the spectrum analyzer performs measurements:

$$f_{in} = f_{LO} - f_{IF}$$

The first mixer produces the sum frequency $f_{LO} + f_{in}$ (= image frequency f_{image}) as well as the difference frequency $f_{LO} - f_{in}$.

The image frequency is rejected by the bandpass at the IF so that it does not interfere with the subsequent frequency conversions.

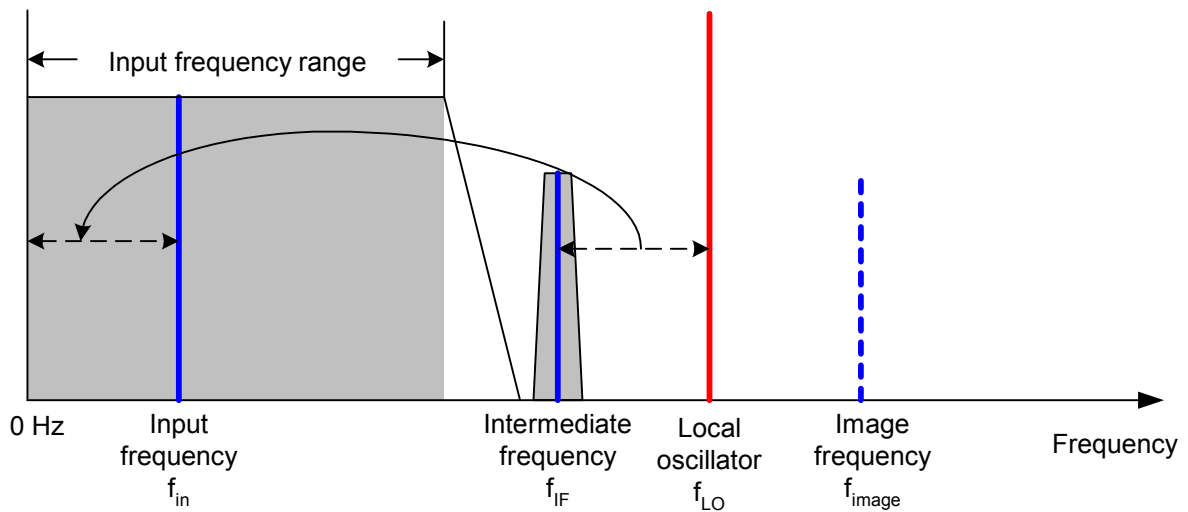

The first local oscillator is tuned with a sawtooth which simultaneously acts as the x deflection voltage for the display. In practice, synthesizer technology is used to generate the frequency of the first local oscillator and for a digital display.

The instantaneous sawtooth voltage therefore determines the input frequency of the spectrum analyzer.

The bandwidth of the IF filter at the IF determines the bandwidth that is used for measurements. Pure sine signals are passed by the IF filter characteristics. This means that signals closer together than the bandwidth of the IF filter cannot be resolved. This is why the bandwidth of the IF filter in a spectrum analyzer is referred to as the resolution bandwidth. The R&S FSH has resolution bandwidths from 1 kHz to 1 MHz.

The bandlimited IF is passed to the envelope detector. The envelope detector removes the IF from the signal and outputs its envelope. The output signal from the envelope detector is referred to as the video signal. As it has been demodulated, it only contains amplitude information. The phase information is lost.

With RF sine signals, the video signal is a DC voltage. With AM signals the video signal contains a DC component whose amplitude corresponds to the carrier power and an AC component whose frequency is equal to the modulation frequency, provided the modulation frequency is inside the resolution bandwidth.

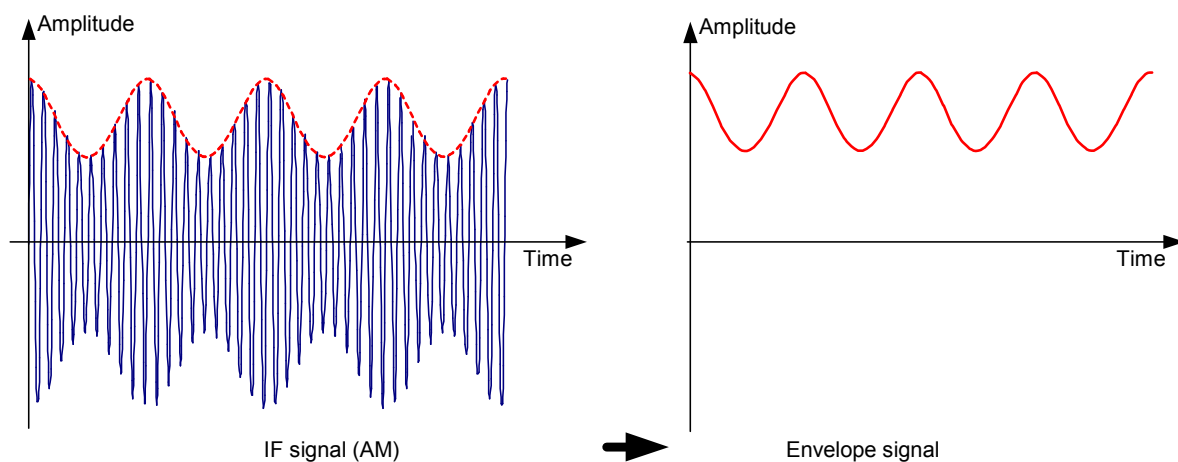

The video filter comes after the envelope detector. The filter is a lowpass with an adjustable cutoff frequency which limits the bandwidth of the video signal. It is particularly useful when sine signals are to be measured in the vicinity of the spectrum analyzer's intrinsic noise. The sine signal produces a video signal that is a DC voltage. At the IF, however, the noise is distributed over the whole bandwidth or, in the case of the video signal, over half the bandwidth of the resolution filter. By selecting a narrow video bandwidth relative to the resolution bandwidth, the noise can be suppressed, while the sine signal to be measured (= DC) is not affected.

The Figs. below show a weak sine signal. In the first Fig., it is measured with a large video bandwidth and in the second with a narrow video bandwidth.

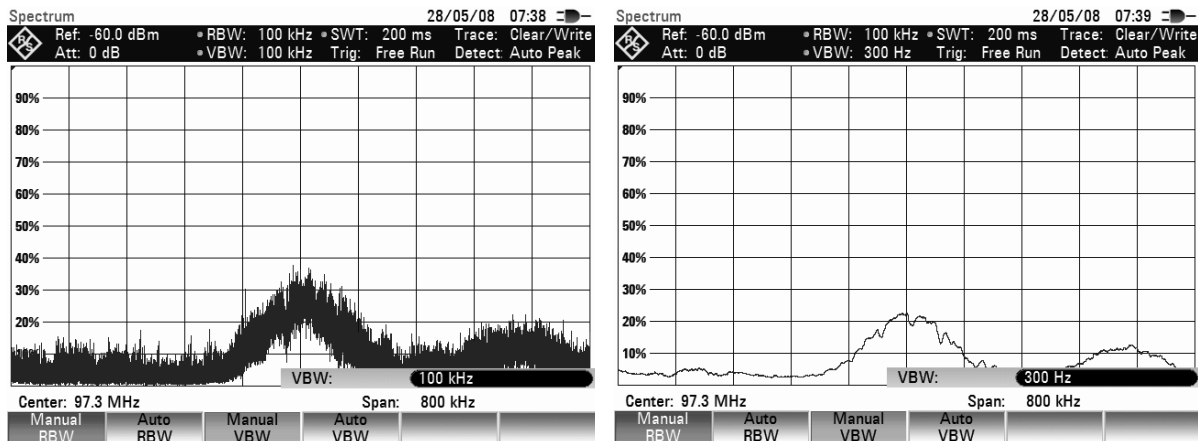

Limiting the video bandwidth smoothes the trace considerably. This makes it much easier to determine the level of the measured signal.

The detector comes after the video filter. The detector combines the measured spectrum so that it can be represented as one pixel in the trace. The R&S FSH uses 301 pixels to form the trace, i.e. the whole measured spectrum has to be represented using just 301 pixels. Common types of spectrum analyzer detectors are the peak detector (PEAK), the sample detector (SAMPLE) and the RMS detector (RMS). An Auto Peak detector which simultaneously displays the maximum peak and the minimum peak is usually also provided. The Fig. below explains how these detectors work.

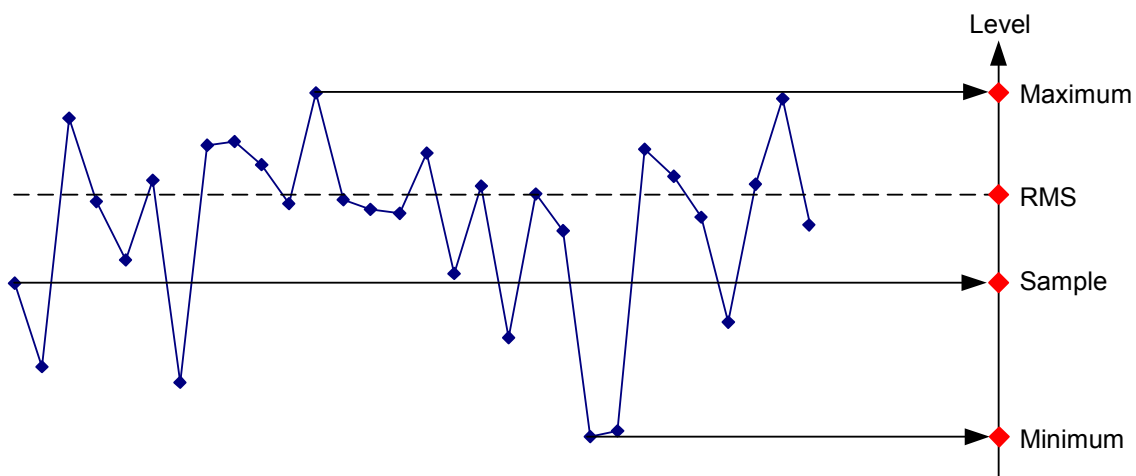

The Fig. above shows 30 measured values which are represented by a single pixel. The peak detector determines and displays the maximum measured value. The Auto Peak detector takes the maximum and minimum and displays them together. The two values are joined by a vertical line segment. This gives a good indication of the level variation over the measured values represented by a single pixel. The RMS detector is used by the spectrum analyzer to determine the RMS value of the measured values. It is therefore a measure of the spectral power represented by a pixel. The sample detector takes an arbitrary measurement value and displays it (in the Fig. above, the first). The other measured values are ignored.

On the basis of the operating principles of detectors, a few recommendations can be made as to their use.

- It is best to use the Auto Peak detector or the peak detector for spectrum analysis over large frequency ranges. This ensures that all signals are displayed.
- The RMS detector is recommended for power measurements on modulated signals. However, the display range should be chosen so as not to exceed 100 times the bandwidth of the signal or the resolution bandwidth, whichever is larger.
- The sample detector or the RMS detector (preferred) should be used for noise measurements. Only these two detectors are capable of measuring noise power correctly.
- When measurements are made on sine signals, the level display does not depend on the detector. However, if you use the RMS detector or the sample detector, ensure that the span is not too great. Otherwise, the displayed levels of sine signals may be lower than their true value.

