



ABN 43 064 478 842

231 Osborne Avenue Clayton South, VIC 3169  
PO Box 1548, Clayton South, VIC 3169  
t 03 9265 7400 f 03 9558 0875  
freecall 1800 680 680  
www.tmgtestequipment.com.au

## Test & Measurement

- > sales
- > rentals
- > calibration
- > repair
- > disposal

## Complimentary Reference Material

This PDF has been made available as a complimentary service for you to assist in evaluating this model for your testing requirements.

TMG offers a wide range of test equipment solutions, from renting short to long term, buying refurbished and purchasing new. Financing options, such as Financial Rental, and Leasing are also available on application.

TMG will assist if you are unsure whether this model will suit your requirements.

Call TMG if you need to organise repair and/or calibrate your unit.

If you click on the "Click-to-Call" logo below, you can call us for FREE!

TMG Corporate Website

TMG Products Website



Click-to-Call  
TMG Now



Product Lifecycle Management System

### Disclaimer:

All trademarks appearing within this PDF are trademarks of their respective owners.



Version  
02.01November  
2006

## Signal Generator R&S® SMA100A

The new standard of excellence in the analog signal generator class

- ◆ Excellent signal quality
- ◆ Ideal for use in production
- ◆ All-purpose instrument
- ◆ Mil/Aero applications
- ◆ Intuitive operating concept
- ◆ Versatile interfaces



Signal quality, speed and flexibility – these are the criteria by which signal generators are measured today. The R&S®SMA100A perfectly meets these criteria, and thus is a premium-class analog generator that sets new standards due to its outstanding characteristics.

The R&S®SMA100A combines superior signal quality with very high setting speed, which makes it ideal for any task. Whether in development, production, service or maintenance, the R&S®SMA100A does an excellent job.

In the frequency range from 9 kHz to 6 GHz, it can generate CW signals as well as all common types of analog modulation (AM, FM,  $\phi$ M, pulse modulation). Excellent specifications and a wide range of modulation signals – these are the characteristic features of the R&S®SMA100A.

In addition, a low-jitter clock synthesizer option supplies differential clock signals of up to 1.5 GHz independently of the RF frequency. This makes the R&S®SMA100A suitable for a variety of applications – from use in phase noise test systems through to tests on mixed-signal ICs.

The Signal Generator R&S®SMA100A also offers a modern graphical user interface for fast and intuitive operation.

### Excellent signal quality

- ◆ Very low SSB phase noise of typ.  $-135$  dBc (20 kHz carrier offset,  $f = 1$  GHz, 1 Hz measurement bandwidth), typ.  $-140$  dBc with the Enhanced Phase Noise Performance option (R&S®SMA-B22)
- ◆ Wideband noise of typ.  $-160$  dBc ( $>10$  MHz carrier offset,  $f = 1$  GHz, 1 Hz measurement bandwidth)
- ◆ Nonharmonics of typ.  $-100$  dBc ( $>10$  kHz carrier offset,  $f < 1500$  MHz, with the R&S®SMA-B22 option)
- ◆ Very low phase noise at low frequencies due to internal division of the fundamental frequency range (750 MHz to 1500 MHz) down to 6.6 MHz
- ◆ High-stability reference oscillator as standard

### Ideal for use in production

- ◆ Very short frequency and level setting times of  $<3$  ms across the entire frequency and level range,  $<450$   $\mu$ s in the list mode
- ◆ Fast hopping mode with flexibly addressable frequency and level pairs, as fast as normal list mode
- ◆ Frequency setting time of typ.  $<10$   $\mu$ s within a bandwidth of up to 80 MHz due to direct access to the DDS-based synthesizer (with the R&S®SMA-B20 or -B22 option)
- ◆ Electronic attenuator with built-in overvoltage protection over entire frequency range
- ◆ High output power of up to +18 dBm, overrange up to typ. +28 dBm
- ◆ Very high level accuracy and repeatability
- ◆ Minimum space requirements due to compact size (only two height units)

### Mil/Aero applications

- ◆ Pulse modulator with excellent characteristics (on/off ratio typ. 100 dB, rise/fall time typ. 10 ns)
- ◆ Pulse generator integrated as standard
- ◆ Optional high-performance pulse generator with minimum pulse width of 20 ns (R&S®SMA-K23)
- ◆ Optional removable mass storage (compact flash disk, R&S®SMA-B80)
- ◆ Optional VOR/ILS modulation (R&S®SMA-K25)
- ◆ Optional operating altitude up to 4600 m (R&S®SMA-B46)

### All-purpose instrument

- ◆ Frequency range of 9 kHz to 6 GHz
- ◆ Frequency, level and LF sweeps
- ◆ AM, broadband FM/ $\phi$ M (R&S®SMA-B20 or -B22), pulse modulation
- ◆ Built-in LF generator up to 1 MHz, optional multifunction generator (R&S®SMA-K24) up to 10 MHz
- ◆ Optional low-jitter clock synthesizer up to 1.5 GHz (R&S®SMA-B29)

### Intuitive operating concept

- ◆ Color display with  $320 \times 240$  pixels ( $1/4$  VGA)
- ◆ Intuitive user interface with graphical display of signal flow (block diagram)
- ◆ Context-sensitive online help

### Versatile interfaces

- ◆ Remote control via GPIB or LAN
- ◆ USB connectors (e.g. for keyboard, mouse, memory stick)
- ◆ Connector for R&S®NRP power sensors for precise power measurements
- ◆ Selectable SCPI- or 8662A/63A-compatible IEC/IEEE bus command set
- ◆ Control via remote operation tool (e.g. VNC)

## Excellent signal quality

The R&S®SMA100A is the ideal solution for measurement applications requiring high spectral purity, e.g. adjacent-channel or phase-noise measurements, and is also optimal for use as a local oscillator or VCO.

Due to an innovative synthesizer concept, the standard version of the instrument already offers excellent values in terms of broadband noise, SSB phase noise and nonharmonics suppression. The Enhanced Phase Noise Performance and FM/φM Modulator option (R&S®SMA-B22) even further

improves SSB phase noise for frequency offsets of up to approx. 100 kHz as well as nonharmonics suppression. The R&S®SMA100A is, therefore, the ideal signal source for measurement tasks that place exacting requirements on spectral purity (e.g. A/D and D/A converter tests).

Frequency synthesis is implemented by division of the fundamental frequency range (750 MHz to 1500 MHz) down to 6.6 MHz. In the lower frequency range from 6.6 MHz, this yields spectral purity on par with that of high-grade crystal oscillators.

The oven-controlled crystal oscillator (OXCO) built in as standard provides very high frequency accuracy and stability. These characteristics are even further improved with the Enhanced Phase Noise Performance and FM/φM Modulator option (R&S®SMA-B22).

In summary, the R&S®SMA100A's outstanding signal quality makes it **THE** analog state-of-the-art signal generator for even the most exacting demands.

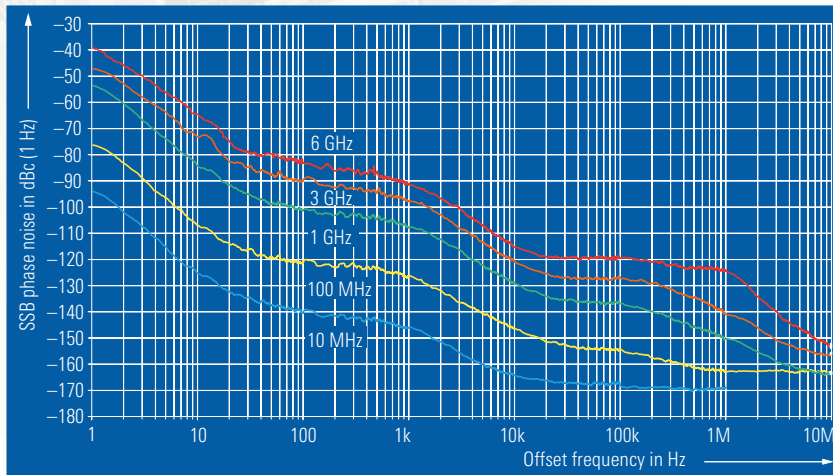

Typical SSB phase noise with internal reference oscillator (standard instrument)

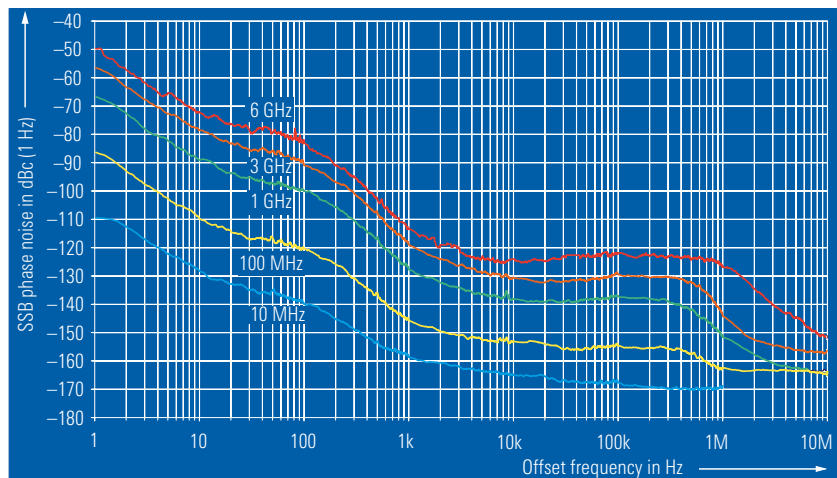

Typical SSB phase noise with internal reference oscillator (with Enhanced Phase Noise Performance and FM/φM Modulator R&S®SMA-B22)

## Ideal for use in production

In production and ATE applications, the test equipment must provide short setting times in order to ensure high throughput and low measurement costs.

The R&S®SMA100A features the very short level and frequency setting times that Rohde & Schwarz signal generators are known for and is thus an ideal choice in time-critical measurement systems. Setting times are already shorter than 3 ms in normal operation. A further significant reduction (<450  $\mu$ s) is achieved in the list mode, which uses frequency and level settings previously stored in a list.

In the fast hopping mode, the R&S®SMA100A features setting times as short as in the list mode. In contrast to the list mode, up to 10000 frequency and level pairs can be addressed as desired via a serial bus.

The electronic attenuator enables rapid and wear-free level setting of the generator. The level setting range is from -145 dBm to +13 dBm (+20 dBm overrange) for  $f \leq 3$  GHz, and from -145 dBm to +9 dBm (+16 dBm overrange) for  $f > 3$  GHz. Higher output levels of up to typ. +28 dBm can be provided by using the relay-switched high-power bypass implemented in the R&S®SMA100A. Overvoltage protection is integrated as standard over the entire frequency range.

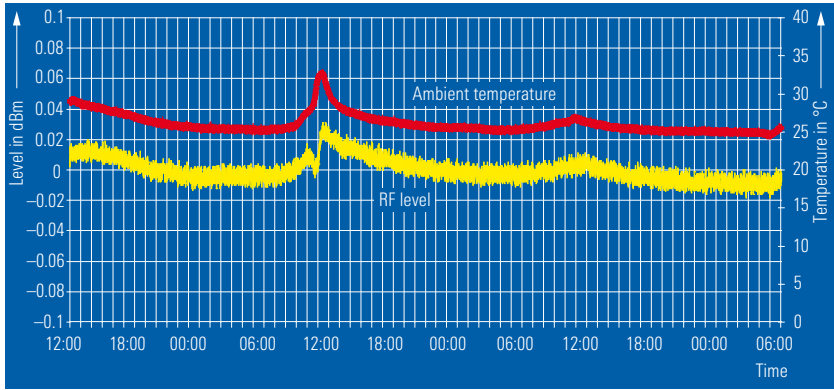

**R&S®SMA 100A level repeatability at 2.1 GHz, 0 dBm, ALC ON**

For applications requiring a level setting range not exceeding 30 dB, a more favorably priced solution is available in the form of a frequency option without an attenuator (R&S®SMA-B103L/-B106L).

The high level accuracy and repeatability of the R&S®SMA100A ensure results of utmost precision in series measurements.

With a compact size of only two height units, the signal generator takes up a minimum of space in 19" racks.

## All-purpose instrument

The signal generator has a lower frequency limit of 9 kHz, which makes it suitable for use in EMC applications. The upper frequency limit is 3 GHz or 6 GHz.

Amplitude and pulse modulation are provided as standard; frequency and phase modulation with a bandwidth of 10 MHz can be implemented optionally (R&S®SMA-B20/-B22).

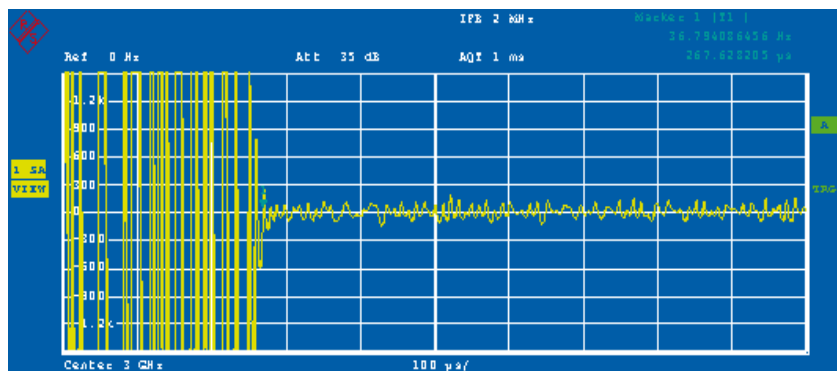

**Setting time after frequency change in List mode (frequency deviation versus time)**

The Enhanced Phase Noise Performance and FM/ $\phi$ M Modulator option (R&S®SMA-B22) keeps phase noise low even when FM is switched on. The phase noise caused by modulation does not become visible until FM deviation exceeds 100 kHz. A special low-noise mode allows modulation using the reference frequency only.

These characteristics make the R&S®SMA100A suitable for phase noise measurements on free-running VCOs, making complex delay-line measurements superfluous.

The RF signal can be internally modulated by means of the built-in LF generator or the optional multifunction generator (R&S®SMA-K24). The multifunction generator supplies various waveforms including sinewave, square-wave, user-programmable trapezoidal waveforms or noise with selectable bandwidth. Modulation signals can be added together with different weighting applied to the individual signals. The modulation signals for AM/FM/ $\phi$ M and for the LF output can be set independently of one another.

Based on this concept, the new signal generator offers a level of modulation flexibility previously unknown in analog signal generators. For example, all types of two-tone modulation can be implemented; you can add together two internal modulation signals or one external and one internal signal.

Using noise as a modulation signal, the R&S®SMA100A generates defined and adjustable phase or FM noise to simulate, for example, a VCO or an interference signal of variable spectral purity for receiver tests.

Moreover, the R&S®SMA-B20 and -B22 FM/ $\phi$ M options can be used to implement extremely fast frequency changes (across a limited frequency range). Direct access to the DDS-based synthesizer yields frequency setting times of typ.  $<10 \mu\text{s}$  across a range of max. 80 MHz. This allows fast frequency hopping transmitters to be simulated, for example.

For pulse modulation, the R&S®SMA100A includes as standard a high-quality pulse modulator with an

on/off ratio of  $>80 \text{ dB}$  and a rise/fall time of typ. 10 ns as well as a basic pulse generator. Optionally, a high-performance pulse generator with a minimum pulse width of 20 ns and a variety of setting options is available (R&S®SMA-K23).

Equipped with the R&S®SMA-K25 option, the R&S®SMA100A can generate avionics signals (VOR/ILS) in accordance with ICAO standard. Due to its low modulation error and very high level accuracy, the R&S®SMA100A is the optimal high-precision VOR/ILS signal source for testing avionics receivers.

Tests on integrated RF circuits frequently require an ultra-pure clock signal in addition to the RF signal. In the past, an extra signal generator was usually necessary in this case. The R&S®SMA100A delivers an extremely low-jitter clock signal (R&S®SMA-B29 clock synthesizer option), which can be set independently of the RF output signal. The clock signal is available as a differential signal in the frequency range from 100 kHz to 1.5 GHz at two separate connectors. It enables, for example, A/D converter tests using only a single signal generator.

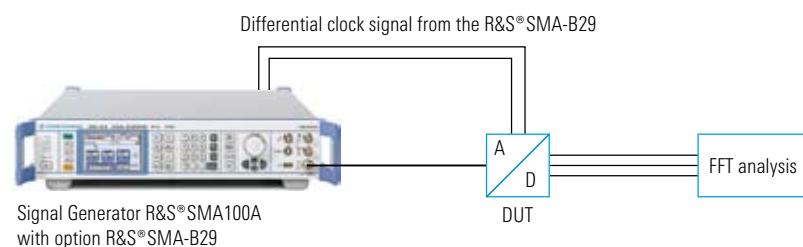

**Application example: A/D converter test with the R&S®SMA100A**

## Intuitive operating concept

The signal flow is shown by a straightforward block diagram on the R&S® SMA 100A color display (320 × 240 pixels, ¼ VGA).

Thus, you can immediately see the activated and deactivated generator blocks and where you can make settings.

To make settings, use the rotary knob, the cursor and function keys or a USB mouse and/or keyboard.

The above features combine to make operation of the R&S® SMA100A easy and intuitive.

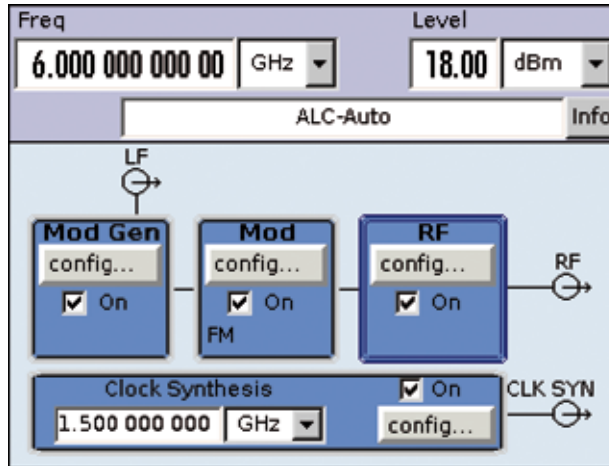

*Block diagram of the R&S® SMA 100A*

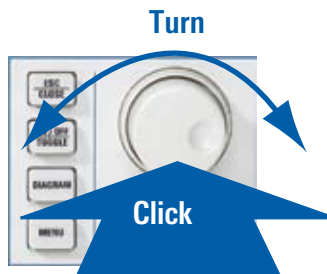

*Rotary knob for navigation in the menus*

## Connectors

The R&S® SMA100A can be remotely controlled via GPIB or LAN and also manually operated from an external PC using remote desktop control (VNC).

Two USB connectors on the front and the rear panel allow the use of USB devices such as a mouse or a memory stick.



*Rear view of the R&S® SMA100A and its versatile interfaces*



## Other features

With automatic test systems, users often wish to run existing test software on new equipment.

In addition to the common SCPI remote-control command set, the R&S® SMA100A offers an 8662A/63A-compatible command set.

For areas where security is an issue, an ejector option (R&S® SMA-B80) is available, by means of which the mass storage medium (compact flash disk containing all stored settings) can be removed from the instrument.

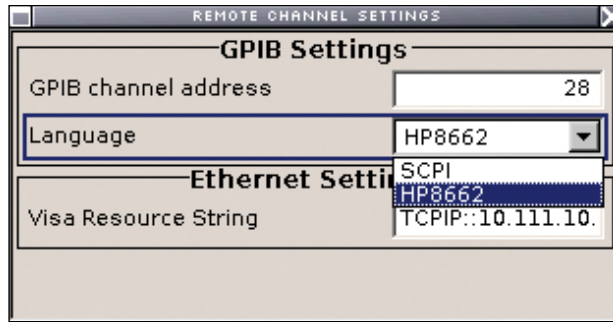

*Selection of IEC/IEEE bus command set*



*CompactFlash™ Card ejector on instrument rear side*

## Specifications in brief

<b>Frequency</b>	
Frequency range	9 kHz to 3 GHz/6 GHz
<b>Level</b>	
Range	−145 dBm to +18 dBm (up to 28 dBm overrange)
Setting time for frequency and level	<3 ms
Setting time in list mode/fast hopping mode	<450 μs
<b>Spectral purity (at f = 1 GHz)</b>	
Nonharmonics (carrier offset >10 kHz, f ≤ 1500 MHz)	<−80 dBc (typ. −90 dBc) <−90 dBc (typ. −100 dBc) with option R&S® SMA-B22
SSB phase noise (20 kHz carrier offset, 1 Hz measurement bandwidth)	<−131 dBc (typ. −135 dBc) <−136 dBc (typ. −140 dBc) with option R&S® SMA-B22
Wideband noise (carrier offset >10 MHz, 1 Hz measurement bandwidth, 750 MHz < f ≤ 1500 MHz)	<−153 dBc (typ. −160 dBc)
<b>Supported modulation modes</b>	
AM	standard
FM/φM	optional (with option R&S® SMA-B20/-B22)
Pulse	standard
VOR/ILS	optional (with option R&S® SMA-K25)
<b>Clock synthesis</b>	
Frequency range	100 kHz to 1.5 GHz (with option R&S® SMA-B29)
<b>Interfaces</b>	
	IEEE 488.2, LAN (10/100BaseT), 2 × USB, 1 × USB slave

## Ordering information

Designation	Type	Order No.
Signal Generator <sup>1)</sup>	R&S®SMA100A	1400.0000.02
Including power cable, Quick Start Guide and CD-ROM (with operating and service manual).		
<b>Options</b>		
RF Path		
9 kHz to 3 GHz with electronic attenuator	R&S®SMA-B103	1405.0209.02
9 kHz to 6 GHz with electronic attenuator	R&S®SMA-B106	1405.0809.02
9 kHz to 3 GHz without attenuator	R&S®SMA-B103L	1405.0609.02
9 kHz to 6 GHz without attenuator	R&S®SMA-B106L	1405.1005.02
FM/φM Modulator	R&S®SMA-B20	1405.1605.02
Enhanced Phase Noise Performance and FM/φM Modulator	R&S®SMA-B22	1405.1805.02
Clock Synthesizer	R&S®SMA-B29	1400.2503.02
Operating Altitude up to 4600 m	R&S® SMA-B46	1405.1305.02
Removable Mass Storage (compact flash disk)	R&S®SMA-B80	1405.2001.02
Rear Connectors	R&S®SMA-B81	1405.2401.02
High-Performance Pulse Generator	R&S®SMA-K23	1405.2801.02
Multifunction Generator	R&S®SMA-K24	1405.2901.02
VOR/ILS Modulation	R&S®SMA-K25	1405.3008.02
<b>Recommended extras</b>		
Hardcopy manuals (in English, UK)		1400.0075.32
Hardcopy manuals (in English, US)		1400.0075.39
Spare CompactFlash™ Card (R&S®SMA-B80 required)	R&S®SMA-Z10	1405.4004.02
19" Rack Adapter	R&S®ZZA-Z11	1096.3260.00
Keyboard with USB Interface (US characteristic set)	R&S®PSL-Z2	1157.6870.04
Mouse with USB Interface, optical	R&S®PSL-Z10	1157.7060.03
External USB DVD Drive	R&S®PSP-B6	1134.8201.22

<sup>1)</sup> The base unit must be ordered together with an R&S®SMA-B103/-B103L or R&S®SMA-B106/-B106L frequency option.



For specifications, see PD 5213.6412.22  
and [www.rohde-schwarz.com](http://www.rohde-schwarz.com)  
(search term: SMA100A)



**ROHDE & SCHWARZ**

[www.rohde-schwarz.com](http://www.rohde-schwarz.com)

Europe: +49 1805 12 4242, [customersupport@rohde-schwarz.com](mailto:customersupport@rohde-schwarz.com)  
USA and Canada: 1-888-837-8772, [customer.support@rsa.rohde-schwarz.com](mailto:customer.support@rsa.rohde-schwarz.com)  
Asia: +65 65130488, [customersupport.asia@rohde-schwarz.com](mailto:customersupport.asia@rohde-schwarz.com)