



ABN 43 064 478 842

231 Osborne Avenue Clayton South, VIC 3169
PO Box 1548, Clayton South, VIC 3169
t 03 9265 7400 f 03 9558 0875
freecall 1800 680 680
www.tmgtestequipment.com.au

Test & Measurement

- > sales
- > rentals
- > calibration
- > repair
- > disposal

Complimentary Reference Material

This PDF has been made available as a complimentary service for you to assist in evaluating this model for your testing requirements.

TMG offers a wide range of test equipment solutions, from renting short to long term, buying refurbished and purchasing new. Financing options, such as Financial Rental, and Leasing are also available on application.

TMG will assist if you are unsure whether this model will suit your requirements.

Call TMG if you need to organise repair and/or calibrate your unit.

If you click on the "Click-to-Call" logo below, you can call us for FREE!

TMG Corporate Website

TMG Products Website



Click-to-Call
TMG Now

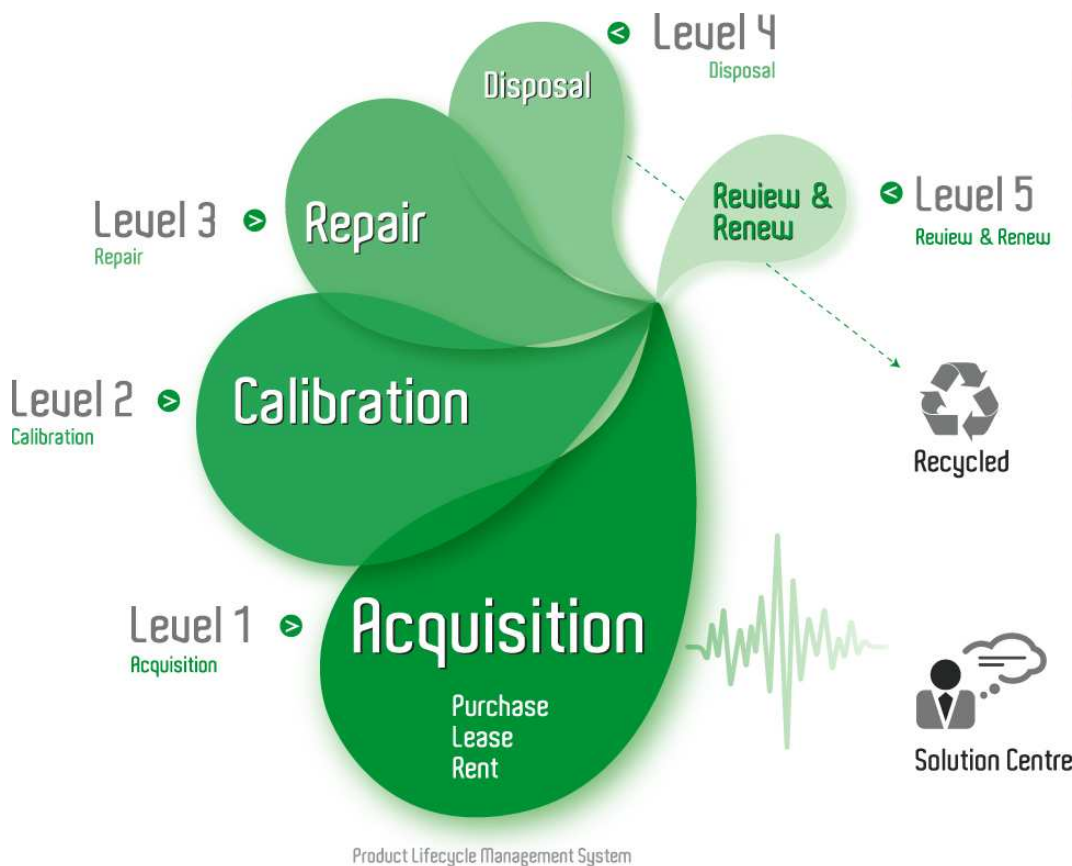

Product Lifecycle Management System

Disclaimer:

All trademarks appearing within this PDF are trademarks of their respective owners.



Version
06.00December
2007

R&S® ZVB Vector Network Analyzers

Frequency ranges up to 4 GHz, 8 GHz, 14 GHz and 20 GHz, with two or four test ports

- ◆ Short measurement time (<4.5 μ s per point)
- ◆ Wide dynamic range >123 dB
- ◆ High output power +13 dBm
- ◆ High power sweep range >50 dB
- ◆ Balanced measurements
- ◆ Parallel measurements
- ◆ Innovative user interface
- ◆ Convenient and flexible analysis function

Highlights

Built using innovative hardware and software concepts, the vector network analyzers of the R&S®ZVB family set new standards: One generator can feed two test ports simultaneously. This makes parallel measurements possible and thus significantly increases performance despite the complexity of the measurement task at hand. In particular, multiport measurements such as performed on balanced SAW filters, duplex filters or antenna switching modules can, therefore, be completed very quickly.

R&S®ZVB 4: 300 kHz to 4 GHz

R&S®ZVB 8: 300 kHz to 8 GHz

R&S®ZVB 14: 10 MHz to 14 GHz

R&S®ZVB 20: 10 MHz to 20 GHz

The R&S®ZVB combines excellent performance with low weight and compact design. Intelligent and user-friendly functions offer maximum ease of operation. They allow the large number of measured quantities involved in multiport and balanced measurements to be handled easily, and also offer a variety of ways to optimize production sequences – a smart solution that satisfies even the most challenging demands.



R&S® ZVB 4, two-port model, compact size



R&S® ZVB 20, four-port model with direct generator/receiver access

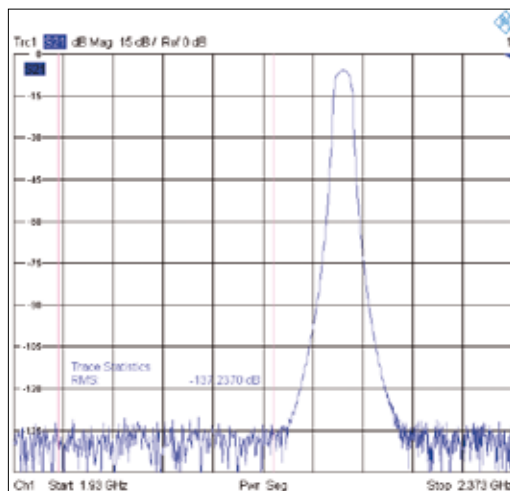

Typical dynamic range of the R&S® ZVB (between test ports; at 1 Hz IF bandwidth)

Innovative concept ...

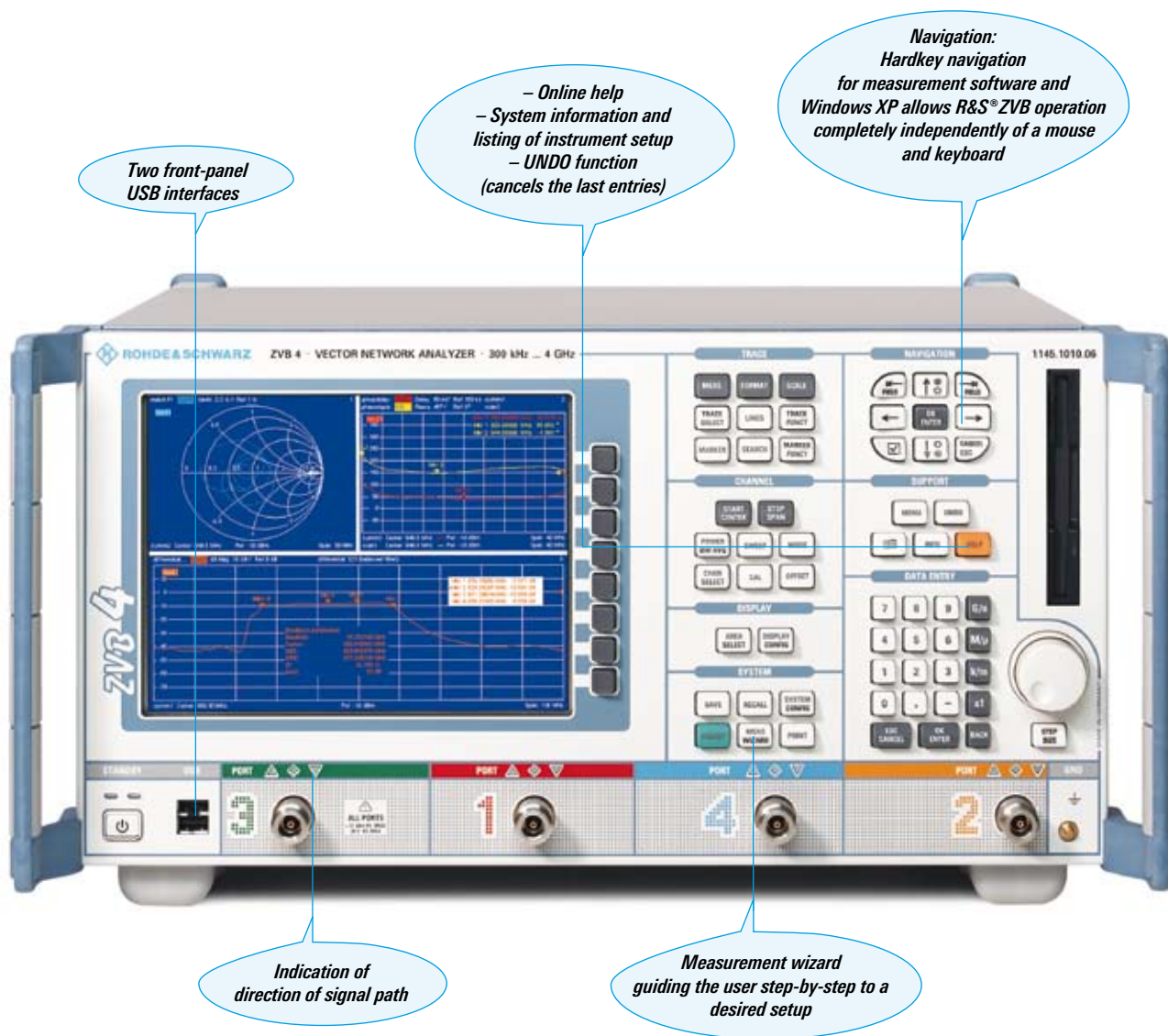

The R&S®ZVB's innovative concept significantly enhances measurement speed, configuration capabilities and system characteristics. The test set consists of reflectometers that have their own measurement and reference channels. The signal from each RF generator is split in order to supply two test ports. Electronic switches in the generator paths permit both alternating and simultaneous signal output at the ports.

Electronic switches for forward/reverse switchover of measurement paths are not required in the test set. For this reason, no asymmetries occur between the analyzer test ports as may otherwise be the case as a result of the cascading of switches.

This means, for example, that the maximum output power of over +13 dBm is available at each of the four test ports irrespective of the direction of measurement. With a maximum dynamic range between the test ports of over >123 dB, the R&S®ZVB features very fast measurement times – even for applications requiring a high dynamic range. The optional direct generator/receiver access increases sensitivity and dynamic range by typically 10 dB.

... for future-oriented performance

High-speed parallel measurements can be achieved because the generator signal can be output to multiple test ports simultaneously, plus data can be captured at multiple ports simultaneously and all displayed at the same time. For example, the R&S®ZVB four-port version makes it possible to measure two two-port DUTs simultaneously, thus doubling performance. It is also possible to measure and display the four reflection parameters S11 to S44 simultaneously on a four-port DUT (provided that DUT ports are uncoupled). This reduces measurement time by a factor of 4 compared with instruments featuring just one generator and a conventional switching technique.

Data processing in the instrument is also carried out in parallel, ranging from RF and IF through to digitization and display. Moreover, data transfer can be performed simultaneously with measurement. The entire execution time for measurements with repeated data transfer via IEC/IEEE bus or LAN is thus determined solely by the measurement time, i.e. transfer time has no effect. This means extremely fast execution times even with complex tasks such as multi-port measurements.

For measurements on active DUTs, power is supplied by a DC bias applied via the inner conductor of each test port. The required DC voltages are supplied to dedicated connectors on the R&S®ZVB rear panel.

R&S®ZVB test set: four-port model

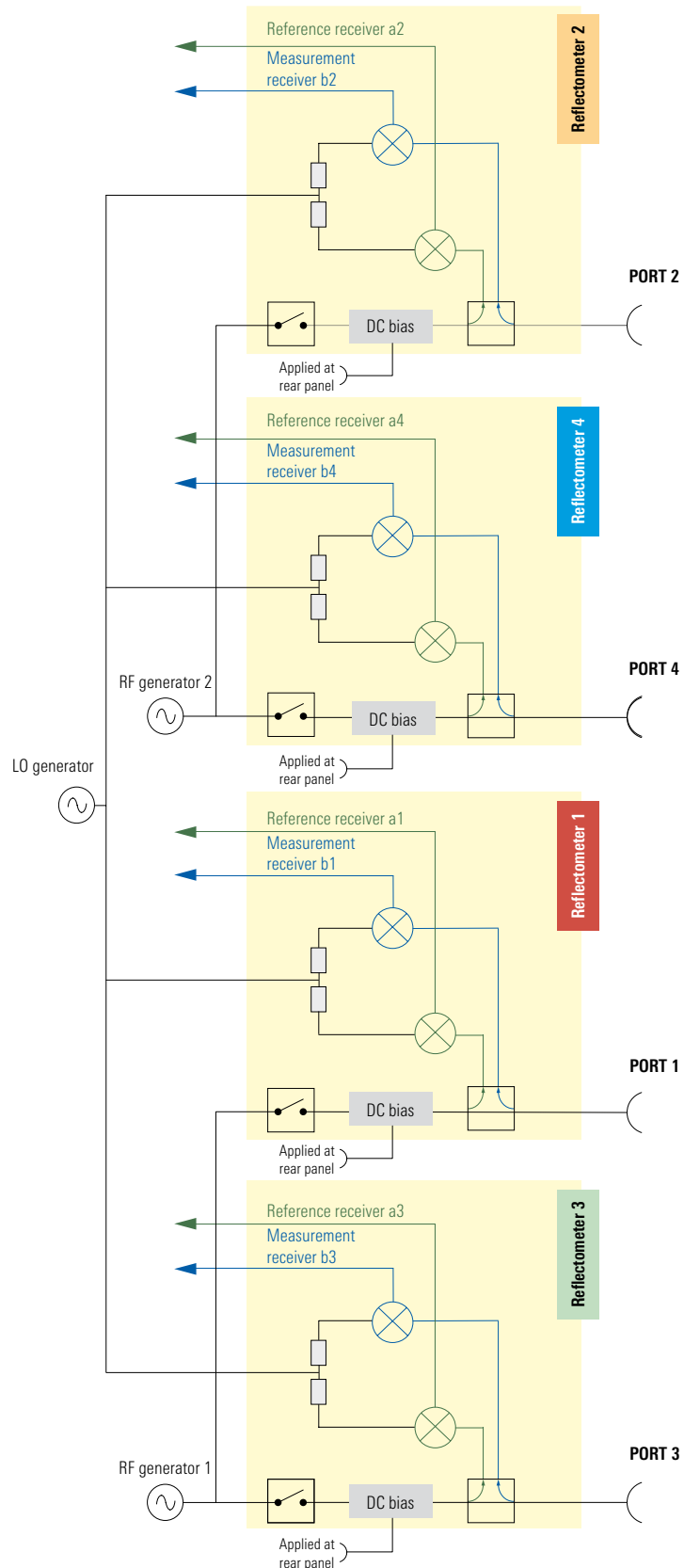

R&S®ZVB test set: two-port model

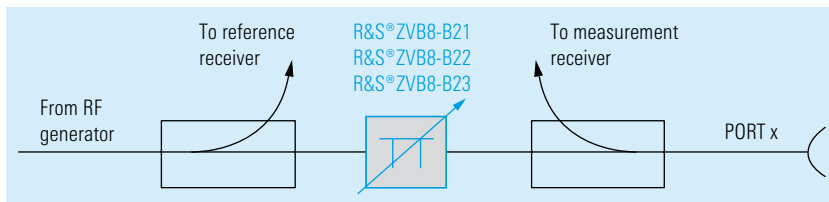
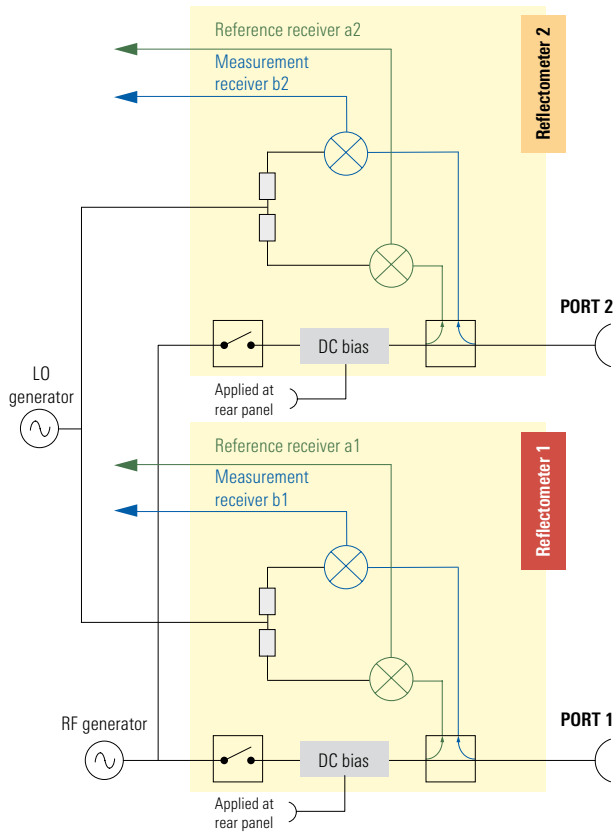

Test set with optional step attenuator

A new dimension ...

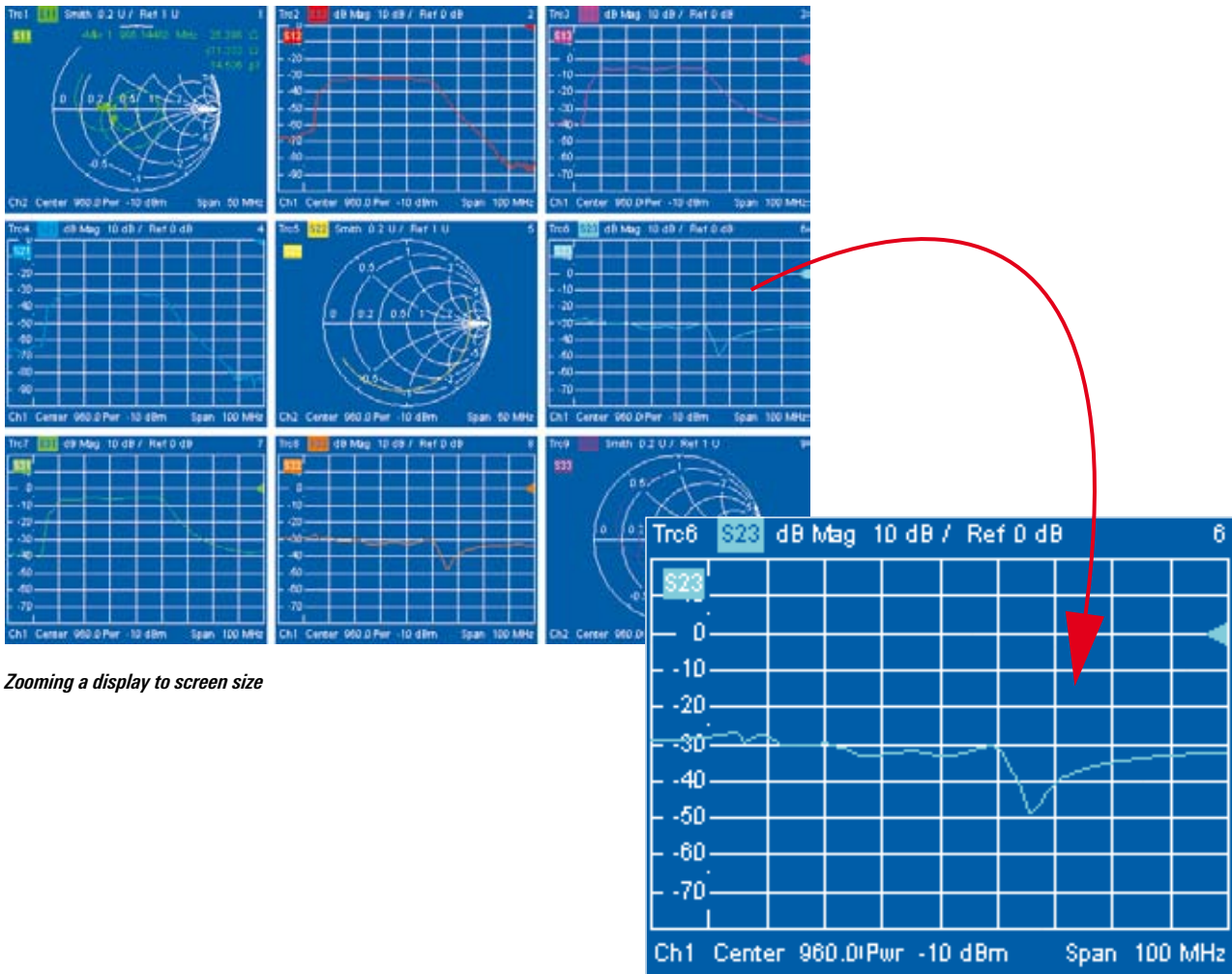

Zooming a display to screen size

User-configurable display of results

- ◆ More than 100 traces and diagrams
- ◆ Flexible assignment of traces to diagrams; hiding and deleting of traces
- ◆ Any combination of channels¹⁾ and traces
- ◆ Adjustment of diagram size by mouse

¹⁾ A channel is understood to designate an independent set of test parameters including, for example, the measurement mode, frequency range, number of measurement points, output power, calibration data and trigger mode. The number of channels is limited only by the instrument's internal memory.

- ◆ Enlarging of individual diagrams to full screen size for optimum readability by clicking the mouse or pressing a key
- ◆ User-definable labeling of diagrams, setups, markers, traces and channels for straightforward documentation

Independent channels

- ◆ Simultaneous management of more than 100 independent channels¹⁾
- ◆ User-definable coupling of traces and channels
- ◆ Simultaneous display of numerous parameters of a DUT under different stimulus conditions

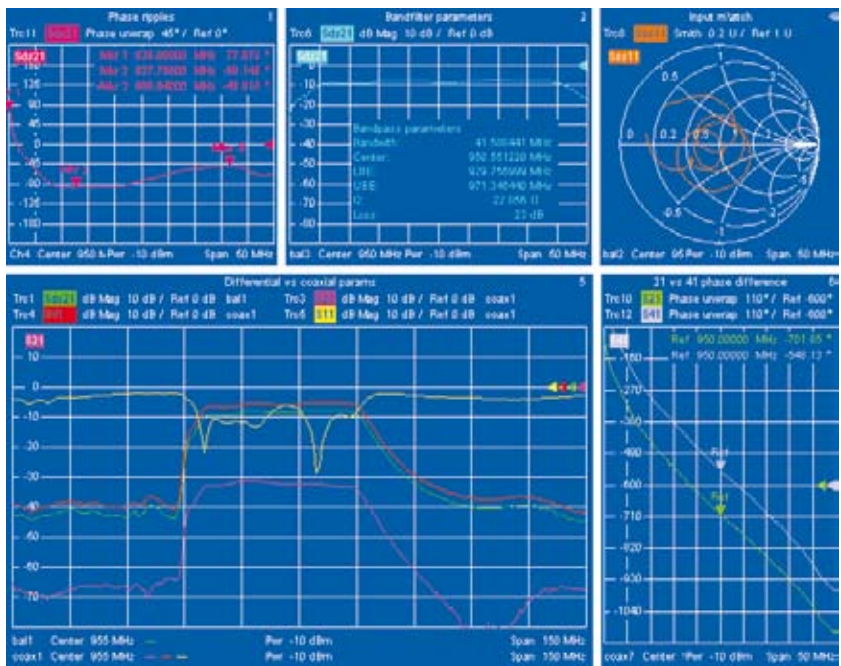

Fast switching between instrument setups

- ◆ Simultaneous loading of several complete instrument setups into RAM (preloading)
- ◆ Each instrument setup represented by a separate measurement window
- ◆ Switching between instrument setups (setup swap) simply by switching between measurement windows by clicking the mouse or pressing a key
- ◆ Extremely fast setup swap by IEC/IEEE bus command in <10 ms
- ◆ Easy management and clear-cut representation of data – even with a large number of different measurements and measured quantities

Measurements on a balanced filter

Switching the setup by activating the corresponding window

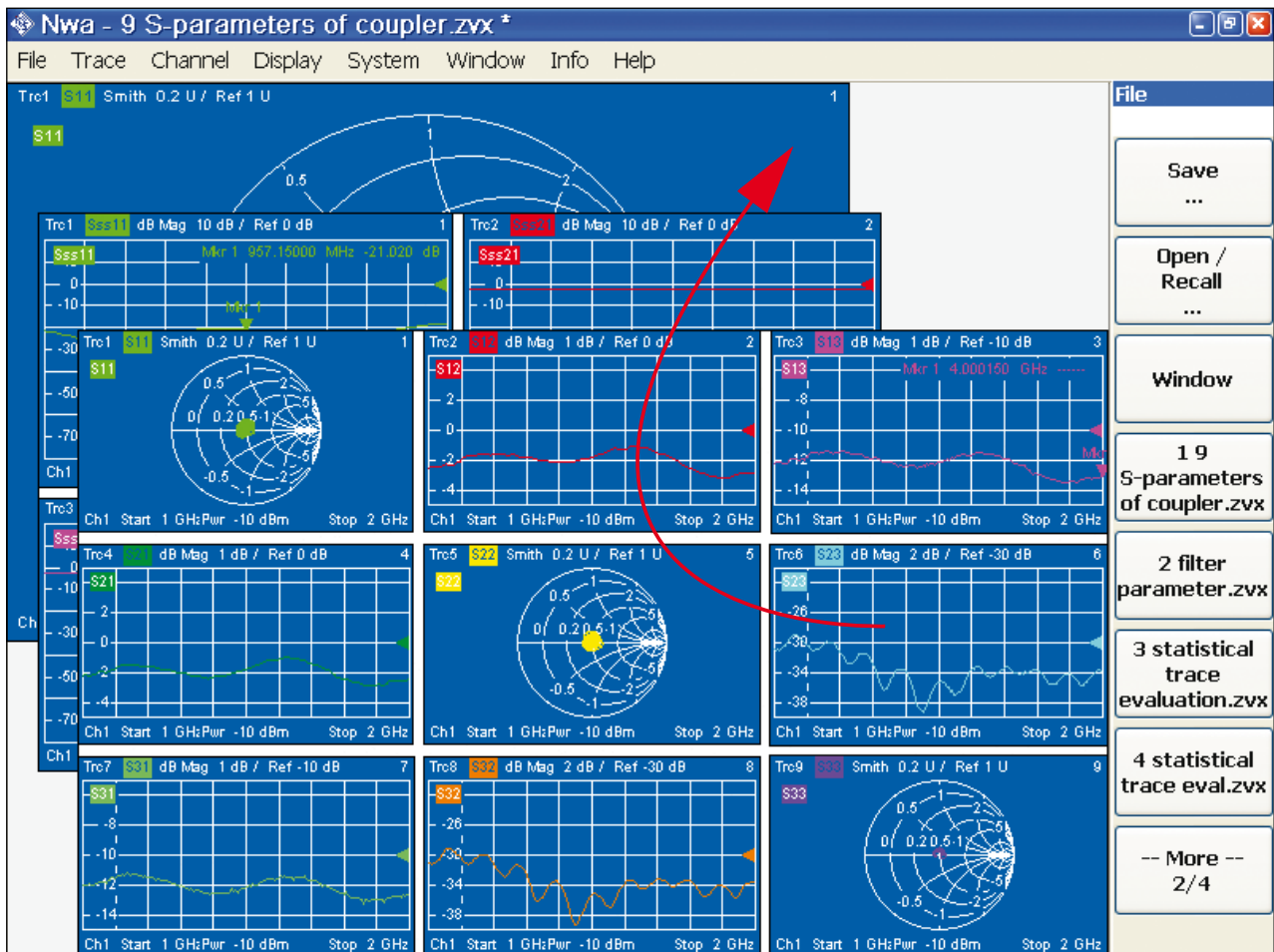

... in functionality

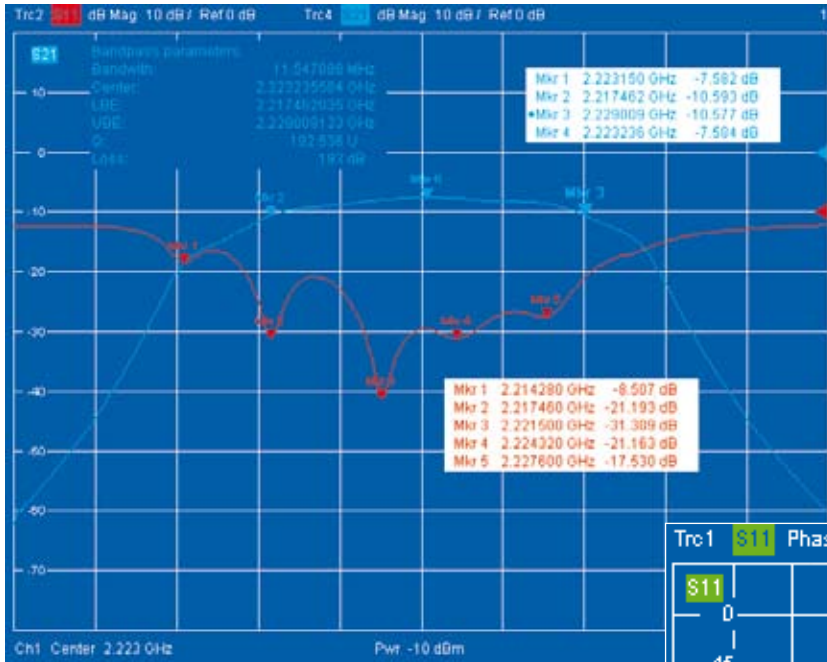

Statistical trace analysis

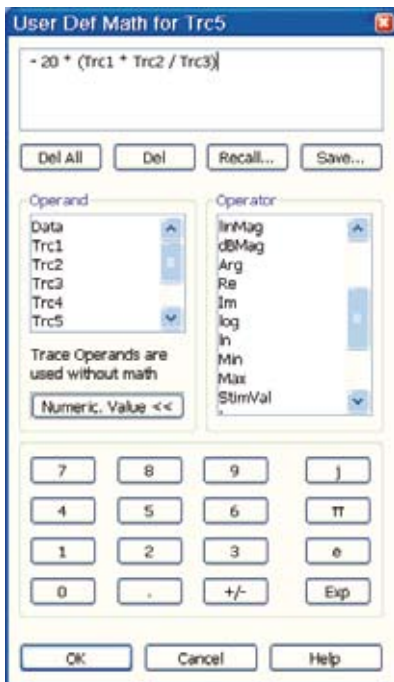
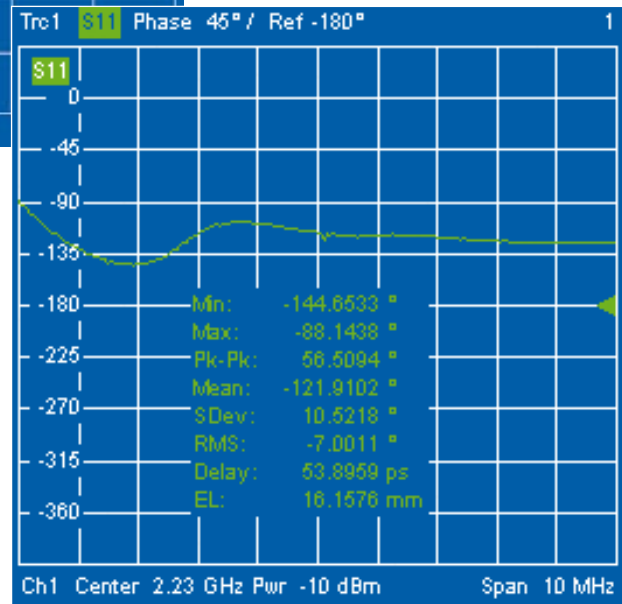

Universal equation editor

Convenient marker and analysis functions

- ◆ Up to 10 markers per trace
- ◆ Various marker data formats
- ◆ Detailed definition of marker properties (line/triangle, information at marker position, etc)
- ◆ Marker information can be positioned on screen as required

- ◆ Marker values can optionally be displayed and printed in the form of a list for clear-cut documentation
- ◆ Marker analysis functions (max./min. search function, analysis functions for filters, compression points, etc)

Editor for trace mathematics

- ◆ Editor with numerous mathematical functions
- ◆ Generation of equations of high complexity
- ◆ Realtime display of almost any quantity derived from data or memory traces

Integrated PC with Windows XP

- ◆ Access to Windows XP operating system for simple integration of peripherals (e.g. CD-ROM drives, USB storage media, printers)
- ◆ Control and analysis software can be run directly on the R&S® ZVB
- ◆ Connectivity via LAN, IEC/IEEE bus, USB, user control (digital I/O)

Manual operation support

- ◆ Operation via hardkeys and softkeys or keyboard and mouse
- ◆ Online help providing information about current menu item including associated IEC/IEEE bus commands
- ◆ Measurement wizard guiding the user step-by-step to the desired setup

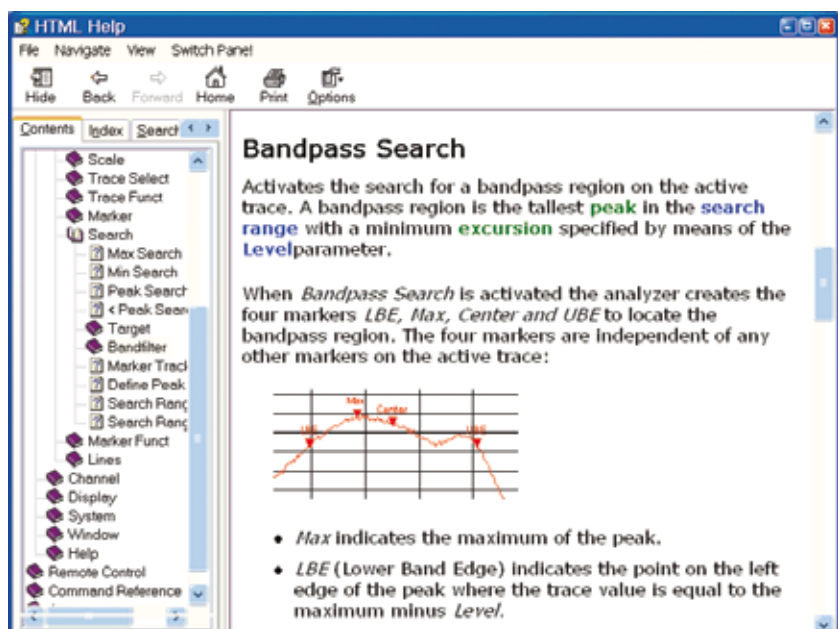

Online help for the active function

Applications ...

Multiport measurements

- ◆ Minimum number of sweeps through parallel data acquisition
- ◆ Extremely fast measurement of multiport devices
- ◆ Excellent accuracy due to multiport calibration

Balanced measurements

- ◆ Analyzer model with up to four integrated test ports
- ◆ Calculation of mixed-mode S-parameters
- ◆ Complete characterization of DUTs with balanced test ports or with mixed single-ended and balanced test ports
- ◆ S-parameters, impedances, admittances, Z- and Y-parameters as well as stability factors can also be measured on differential DUTs

Response power calibration and power measurements

- ◆ Enhanced power accuracy for internal and external generators and for receiver channels
- ◆ Correction of frequency response of test setup and preamplifiers
- ◆ Calibration to within defined tolerance limits
- ◆ Control of external power measurement equipment via USB, IEC/IEEE bus or LAN
- ◆ Power measurements versus frequency and power by means of R&S® NRP power sensors connected directly to the analyzer's USB interfaces
- ◆ Scalar inputs and scalar network analysis through external R&S® NRP power sensors

Filter measurements and adjustments

- ◆ User-configurable diagrams and high sweep speed for convenient manual tuning
- ◆ Marker functions and equation editor for determination of filter characteristics and realtime derivation of desired quantities
- ◆ Limit lines for tuning procedures, including pass/fail indication
- ◆ Generation of limit lines from imported data sets or active trace data
- ◆ Segmented sweep for minimized sweep time and data volume

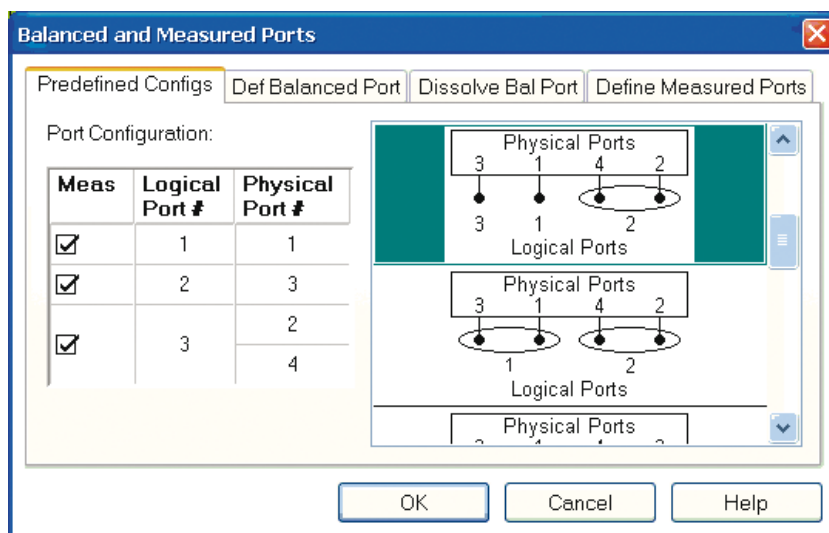

Configuration of a balanced measurement

Measurements on active components

- ◆ Wide power sweep range of more than 50 dB and excellent power linearity for compression measurements
- ◆ High compression point and TOI of receiver for high accuracy at high input levels
- ◆ Two DC measurement inputs with voltage ranges ± 1 V and ± 10 V
- ◆ Display of DC values and quantities derived from the DC values by means of the equation editor
- ◆ Efficiency measurements on amplifiers
- ◆ K and μ stability factors of amplifiers

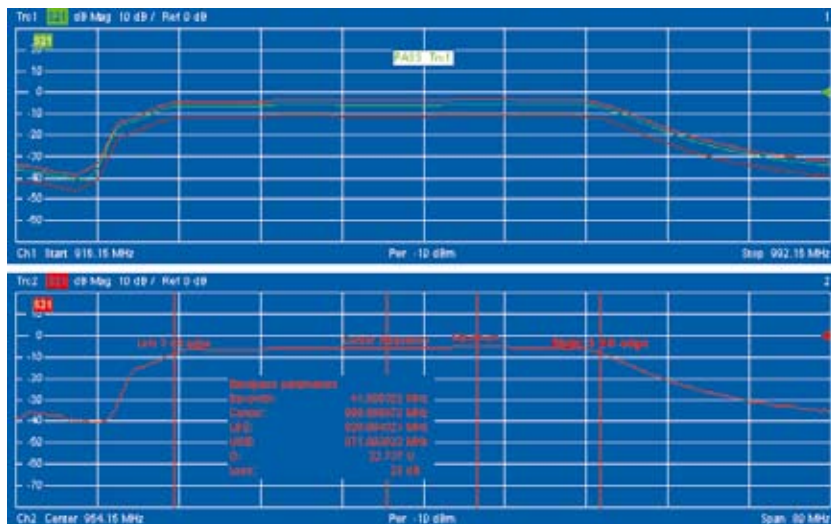

Filter measurements with limit lines, pass/fail indication, bandwidth measurement

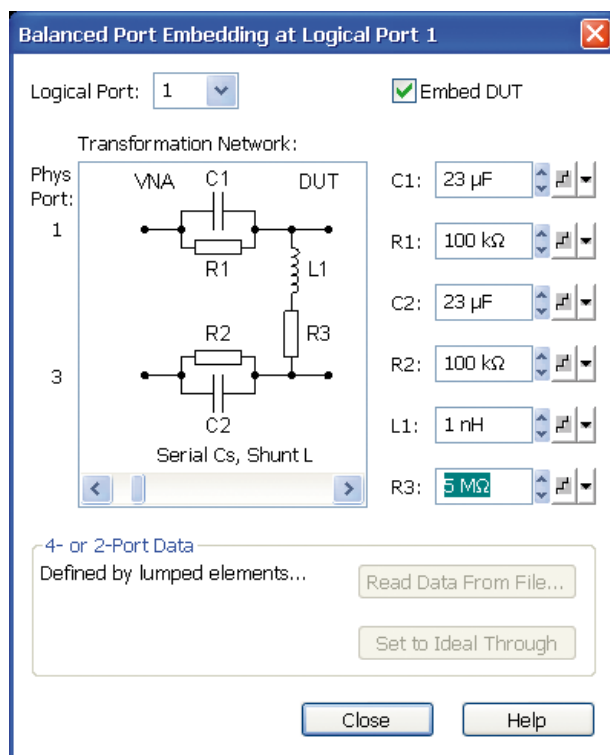

User-definable network for embedding/deembedding

Integrated embedding/deembedding function

- ◆ DUT embedding in matching networks
- ◆ Inclusion of parasitic effects
- ◆ Predefined user-definable networks for single-ended and balanced systems
- ◆ Import of *.s2p and *.s4p files for embedding/deembedding
- ◆ Simultaneous use of predefined single-ended, balanced and imported networks
- ◆ Clear-cut dialog for configuring measurement ports and parameters for embedding/deembedding

... and measurements

Highlights of the R&S®ZVB in production

Integrated PC with Windows XP for automated procedures and data management

- ◆ Analysis and control programs for test and production sequences can be run directly on the R&S®ZVB
- ◆ The R&S®ZVB can be networked with system components such as measuring instruments or handlers via its LAN, IEC/IEEE bus and USB interfaces or its universal TTL interface

Optimization of test and production sequences

- ◆ Switchover between several channels instead of loading setups
- ◆ Simultaneous loading of several instrument setups into RAM (pre-loading) for extremely fast and simple switching between multiple setups via the IEC/IEEE bus in less than 10 ms or at a keystroke or mouse click
- ◆ Segmented sweep for minimized number of points and optimized sweep parameters
- ◆ Flexible trigger options for starting a sweep, sweep segment, point or partial measurement
- ◆ Digital I/O port with signals synchronized to test sequence for fast and direct control of external system components and output of pass/fail information
- ◆ Reflectometer concept for parallel measurements on different ports (e.g. measurement of two two-port DUTs with the R&S®ZVB four-port model)

Mixer and harmonics measurements

- ◆ Conversion loss of mixers versus frequency and power
- ◆ Amplitude of harmonics of any order versus frequency and power
- ◆ LO signal supplied by second internal generator or external generator

Data import and export

- ◆ Export and import of traces in *.snp (Touchstone), ASCII or MATLAB® format
- ◆ Display of imported traces as memory traces or limit lines
- ◆ Access to correction values
- ◆ Access to measured values of calibration standards

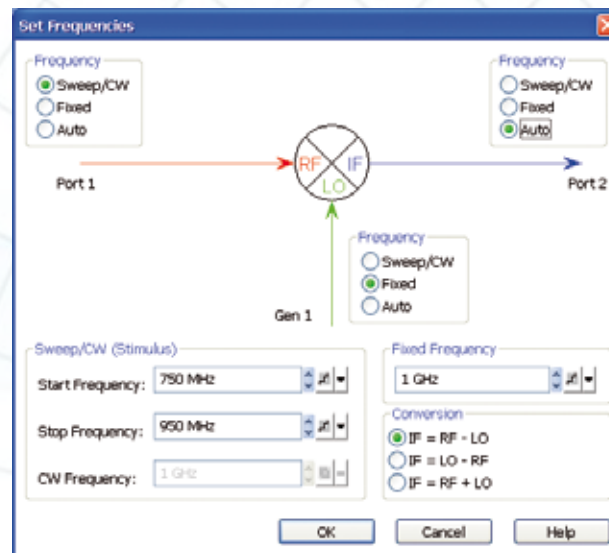

Configuration of a mixer measurement

Measurement times and data transfer times

- ◆ Data transfer via LAN or IEC/IEEE bus
- ◆ Data transfer simultaneous with data acquisition

Calibration functions for maximum flexibility at minimum effort

- ◆ Expanded equivalent circuit models for defining calibration standards (e.g. non-ideal standards for on-wafer calibrations)
- ◆ Definition of calibration standards using S-parameter files
- ◆ Definition of calibration standards in different parameter formats
- ◆ Flexible calibration manager for managing calibrations and assigning them to measurement channels
- ◆ Automatic calibration unit

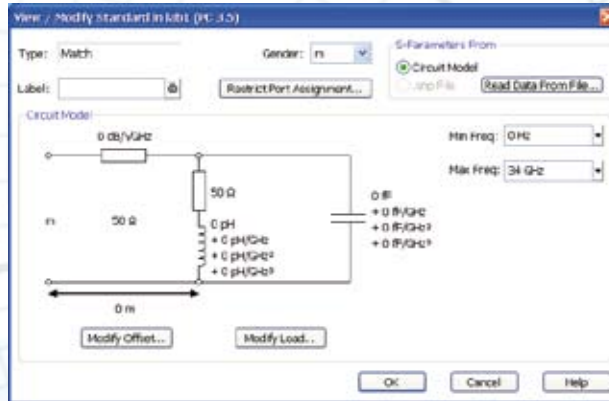

Equivalent circuit model for defining a MATCH

Functions and options

Function	Description	Standard/option
Two or four test ports	Integrated bidirectional RF test ports	Standard with corresp. instrument version
Active test set (PORT BIAS)	Input of DC power for supply of amplifiers via inner conductor of test port; requires external DC power supply	Standard
Multipoint measurements	Complete S-parameter matrix, wave quantities, wave quantity ratios, impedances, admittances, Z- and Y-parameters of multipoint DUTs	Standard
Balanced measurements	Mixed-mode S-parameters, mixed-mode Z- and Y-parameters, impedances and admittances of balanced DUTs	Standard
Mixer and harmonics measurements	Conversion loss of mixers versus frequency or power. Can be used when one of the RF, IF or LO system frequencies is constant. Magnitude of harmonics of any order versus frequency or power. ¹⁾	Option R&S®ZVB-K3
Calibration techniques	TOSM, TRL/LRL, TOM, TRM, TNA, normalization, one path two port	Standard
Power calibration	UOSM for calibration with an unknown through. Includes adapter removal function	Standard
Power measurement and scalar network analysis	Increased power accuracy and test set response calibration. For frequency and power sweeps. Requires an external power meter ¹⁾ . Maximum convenience with R&S®NRP USB sensors.	Standard
Power measurement and scalar network analysis	R&S®NRP power measurement sensors connected directly to the USB ports provide additional inputs: Display of power versus frequency or versus power. In addition to wave quantities, further power measurements or wideband scalar network analysis are thus possible, e.g. for mixer measurements with internal LO (R&S®NRP sensor not included).	Standard
Automatic level control (ALC)	Control of the output power via the signal fed to the reference channel. Corrects drift of preamplifiers and power uncertainty due to mismatch. Provides increased power accuracy and linearity.	Standard
User support	Automatic calibration unit	Options R&S®ZV-Z5x
High number of diagrams, traces and channels	More than 100 traces and channels can be created and assigned to diagrams as required	Standard
Preloading of setups; setup swap	Simultaneous loading of several instrument setups into RAM; fast switchover between instrument setups	Standard
Segmented sweep, lin/log sweep	Optimization of sweep settings	Standard
Time sweep	Determination of measured quantities as a function of time	Standard
60 001 points per trace	High sweep resolution, narrow frequency grid	Standard
IF bandwidths 1 Hz to 500 kHz (in 1/2/5 steps)	Optimization of measurement speed and dynamic range	Standard
Power sweep	Wide power sweep range of more than 50 dB for compression measurements	Standard
Online support functions	Context-sensitive online help, UNDO function for canceling the last user operations, Windows XP key for accessing the operating system, complete listing of current instrument setup including calibration	Standard
Measurement wizard	Step-by-step guidance to the desired instrument setup, including calibration if required	Standard
Trace mathematics, equation editor, marker functions, trace statistics	Functions for online computation of measurement data using complex equations, for adjustments and statistical evaluation (rms, MaxHold, etc)	Standard
Limit lines	Generation of limit lines from traces; data import and export for limit lines	Standard
Trigger functions	Triggers for sweeps, sweep segments, measurement points or partial measurements	Standard
Oven-controlled crystal oscillator	Enhanced frequency accuracy	Option R&S®ZVAB-B4
Interfaces (2 × LAN, 4 × USB, IEC BUS, 10 MHz REF, MONITOR, USER CONTROL, EXT TRIGGER)	Control of the R&S®ZVB, control of external devices or handlers by the R&S®ZVB, fast TTL handler and sequence control, connection of peripherals, e.g. printer or storage media (see also interface description)	Standard
DC inputs	Measurement inputs for DC voltage, allowing PAE (power added efficiency) measurements	Standard
Time domain transform	Display of discontinuities, reflection factor or impedance versus delay/length, step and impulse response, lowpass/bandpass frequency spacing, gated S-parameters	Option R&S®ZVAB-K2
Embedding/deembedding	Inclusion of virtual matching networks, parasitic effects, etc; for coaxial and balanced systems; correction of the influence of test set components; parameterizable predefined networks and/or import of S-parameter files for defining (matching) networks	Standard
Adapter removal	Enables calibration with different types of connectors in the reference planes (e.g. 3.5 mm to N). Requires manual calibration kits of both types.	Standard
Generator step attenuators	Extension of output power down to -110 dBm	Options R&S®ZVB 8-B21/-B22/-B23
Direct generator receiver access	Increased sensitivity and dynamic range by typical 10 dB	Options R&S®ZVB14/20-B16

¹⁾ Option R&S®ZVAB-B44 required for IEC/IEEE-bus-controlled power meters or external generators. For control via LAN, the VISA I/O BIB option is required.

Interface description

Interface	Function
LAN 1	Control of R&S®ZVB or subnetwork with R&S®ZVB as master, 8-pin RJ-45 connector
LAN 2	Control of R&S®ZVB or subnetwork with R&S®ZVB as master, 8-pin RJ-45 connector
IEC BUS	Remote control of R&S®ZVB
AUX	Auxiliary interface for future applications, BNC connector
PORT BIAS	Input of DC power for supply of amplifiers via inner conductor of test port, one input and fuse per RF port, BNC connectors
USB	Standard 1.1 USB double port (for mouse, keyboard, printer, storage media, etc)
10 MHz REF	Reference frequency I/O: 10 MHz reference can be input from, or output to, external devices, BNC connector
DC MEAS	Measurement inputs for DC voltage and PAE measurements, input voltage ranges ± 1 V and ± 10 V, Mini DIN connectors, cable: R&S®ZV-Z71 (option)
MONITOR	For external VGA monitor; output of measurement screen or Windows XP user interface, standard VGA connector
USER CONTROL	TTL I/O signals: sweep status indication, pass/fail indication, indication of active test port, indication of active channel by channel bits, trigger signals for fast control of external devices, e.g. generators, handshake with handlers, sequence control without programming effort, 25-pin D-Sub connector
EXT TRIGGER	Input of external TTL trigger signal for starting a measurement or partial measurement, BNC connector

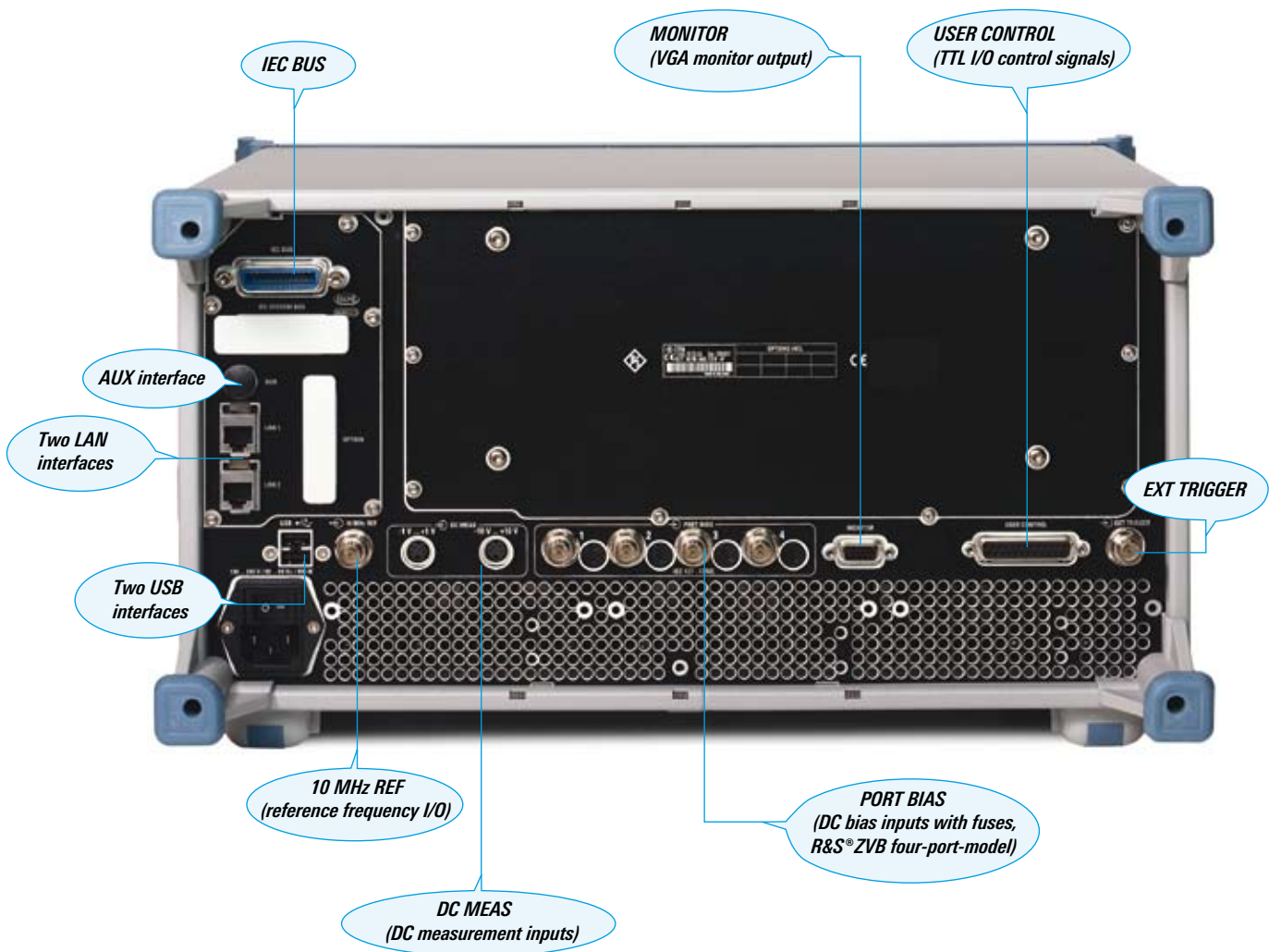

Condensed data

Measurement time per point (CW mode, at 500 kHz IF bandwidth)	<4.5 μ s
Measurement time (including any data transfer time) ¹⁾	<4.5 ms
Data transfer time	data transfer simultaneous with measurement
Dynamic range (at 10 Hz IF bandwidth)	>123 dB
Inherent noise	<-110 dBm
Power sweep range ²⁾	-40 dBm to +13 dBm
IF bandwidths	1 Hz to 500 kHz
Number of measurement points per trace	1 to 60 001
Platform	
Number of test ports	2 or 4
Number of measurement and reference receivers	one measurement and one reference receiver per test port
Number of integrated generators	one generator per test port pair
Calibration techniques	TOSM, UOSM, TRL/LRL, TOM, TRM, TNA, automatic calibration unit
Operating system and internal PC	Windows XP
Operation	hardkeys/softkeys, keyboard and mouse, online help system, measurement and calibration wizard
Number of traces, diagrams, independent channels, setups that can be simultaneously loaded into RAM	>100 ³⁾ , traces can be assigned to diagrams as required

¹⁾ Specification valid for 201 measurement points, measurement bandwidth 500 kHz, display off, ALC off, at 5 GHz, narrow span.

²⁾ Power level that can be electronically swept.

³⁾ Number limited only by internal memory.

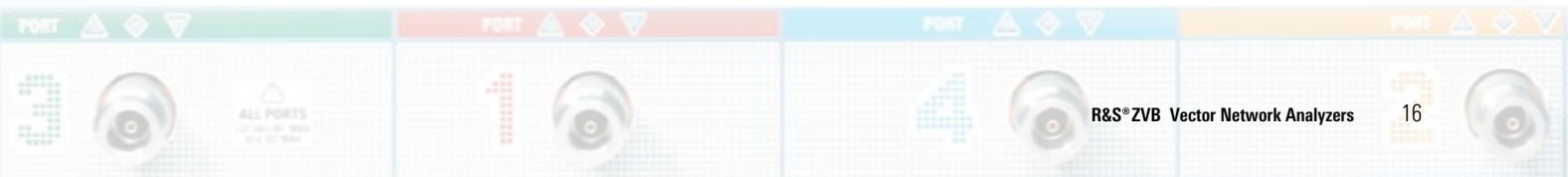
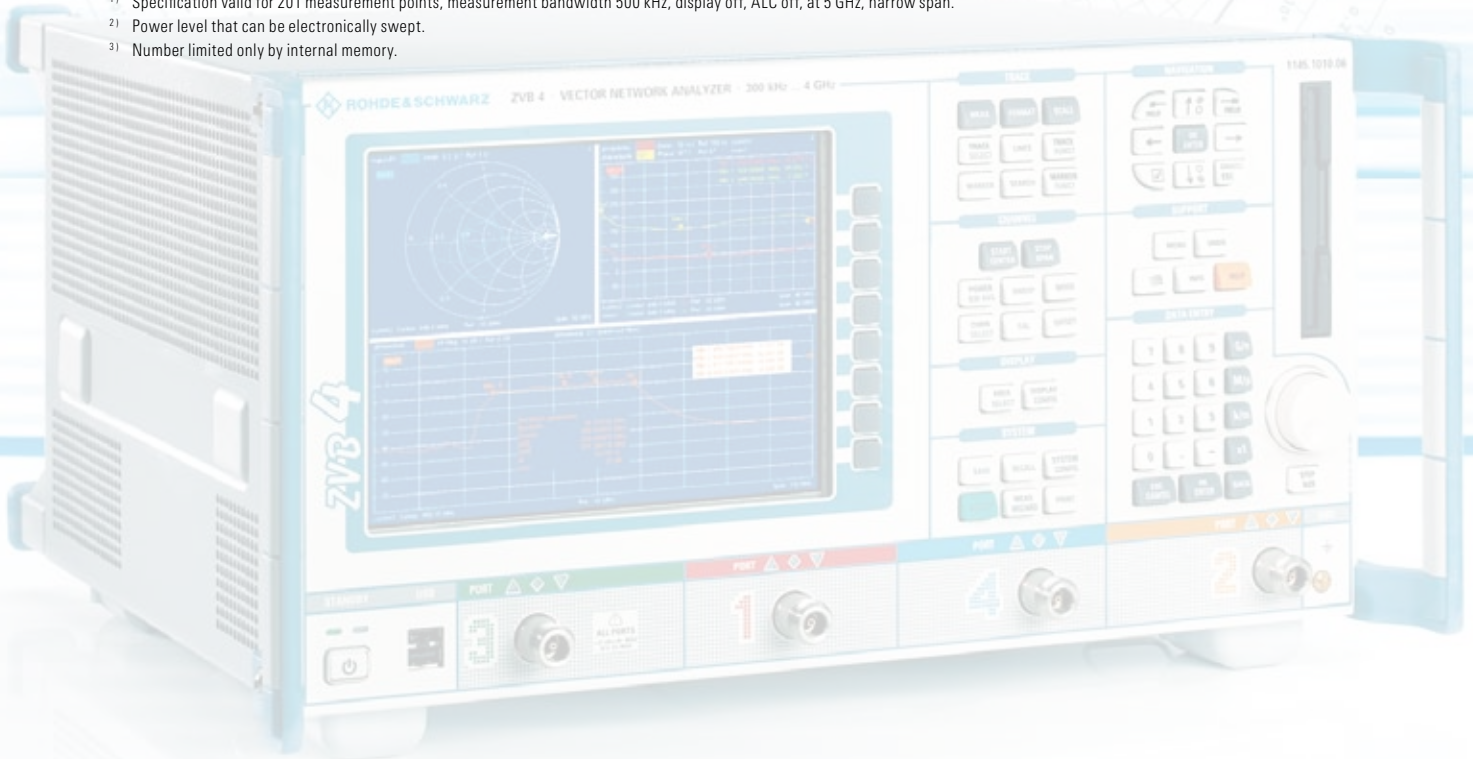

Ordering information

Designation	Type	Frequency range	Order No.
Vector Network Analyzer¹⁾			
2 ports compact size	R&S®ZVB 4	300 kHz to 4 GHz	1145.1010.04
4 ports compact size	R&S®ZVB 4	300 kHz to 4 GHz	1145.1010.06
2 ports compact size	R&S®ZVB 8	300 kHz to 8 GHz	1145.1010.08
4 ports compact size	R&S®ZVB 8	300 kHz to 8 GHz	1145.1010.10
2 ports compact size	R&S®ZVB 14	10 MHz to 14 GHz	1145.1010.14
2 ports	R&S®ZVB 14	10 MHz to 14 GHz	1145.1010.17
4 ports	R&S®ZVB 14	10 MHz to 14 GHz	1145.1010.19
2 ports compact size	R&S®ZVB 20	10 MHz to 20 GHz	1145.1010.20
2 ports	R&S®ZVB 20	10 MHz to 20 GHz	1145.1010.23
4 ports	R&S®ZVB 20	10 MHz to 20 GHz	1145.1010.25
Options			
Time Domain	R&S®ZVAB-K2		1164.1657.02
Mixer and Harmonic Measurements	R&S®ZVB-K3		1164.1592.02
Oven Quartz (OCXO)	R&S®ZVAB-B4		1164.1757.02
Direct Generator/Receiver Access for 2-Port R&S®ZVB14 1145.1010.17	R&S®ZVB14-B16	10 MHz to 14 GHz	1164.1240.17
Direct Generator/Receiver Access for 4-Port R&S®ZVB14 1145.1010.19	R&S®ZVB14-B16	10 MHz to 14 GHz	1164.1240.19
Direct Generator/Receiver Access for 2-Port R&S®ZVB20 1145.1010.23	R&S®ZVB20-B16	10 MHz to 20 GHz	1164.1240.23
Direct Generator/Receiver Access for 4-Port R&S®ZVB20 1145.1010.25	R&S®ZVB20-B16	10 MHz to 20 GHz	1164.1240.25
Generator Step Attenuator Port 1, for R&S®ZVB 4/8 70 dB in 10 dB steps ²⁾	R&S®ZVB 8-B21	300 kHz to 8 GHz	1302.5480.02
Generator Step Attenuator Port 2, for R&S®ZVB 4/8 70 dB in 10 dB steps ²⁾	R&S®ZVB8-B22	300 kHz to 8 GHz	1302.5073.02
Generator Step Attenuator Port 3, for R&S®ZVB 4/8, 70 dB in 10 dB steps ²⁾	R&S®ZVB8-B23	300 kHz to 8 GHz	1302.5496.02
Extras			
Test Cable			
63.5 cm/25", N (m)/N(m) ³⁾	R&S®ZV-Z91	0 Hz to 18 GHz	1301.7572.25
96.5 cm/38", N (m)/N(m) ³⁾	R&S®ZV-Z91	0 Hz to 18 GHz	1301.7572.38
63.5 cm/25", N(m)/3.5 mm (m) ³⁾	R&S®ZV-Z92	0 Hz to 18 GHz	1301.7589.25
96.5 cm/38", N(m)/3.5 mm (m) ³⁾	R&S®ZV-Z92	0 Hz to 18 GHz	1301.7589.38
63.5 cm/25", 3.5 mm (f)/3.5 mm (m) ³⁾	R&S®ZV-Z93	0 Hz to 26.5 GHz	1301.7595.25
96.5 cm/38", 3.5 mm (f)/3.5 mm (m) ³⁾	R&S®ZV-Z93	0 Hz to 26.5 GHz	1301.7595.38
61 cm / 24" N (m)/N (m) ³⁾	R&S®ZV-Z191	0 Hz to 18 GHz	1306.4507.24
91 cm / 36" N (m)/N (m) ³⁾	R&S®ZV-Z191	0 Hz to 18 GHz	1306.4507.36
61 cm / 24" N (m)/3.5 mm (m) ³⁾	R&S®ZV-Z192	0 Hz to 18 GHz	1306.4513.24
91 cm / 36" N (m)/3.5 mm (m) ³⁾	R&S®ZV-Z192	0 Hz to 18 GHz	1306.4513.36
61 cm / 24" 3.5 mm (f)/3.5 mm (m) ³⁾	R&S®ZV-Z193	0 Hz to 26.5 GHz	1306.4520.24
91 cm / 36" 3.5 mm (f)/3.5 mm (m) ³⁾	R&S®ZV-Z193	0 Hz to 26.5 GHz	1306.4520.36
Calibration Kits			
N, 50 Ω	R&S®ZV-Z21	0 Hz to 18 GHz	1085.7099.02
N, 50 Ω	R&S®ZCAN	0 Hz to 3 GHz	0800.8515.52
N (male), 50 Ω	R&S®ZV-Z121	0 Hz to 8 GHz	1164.0496.02
N (female), 50 Ω	R&S®ZV-Z121	0 Hz to 8 GHz	1164.0496.03
N 75 Ω	R&S®ZCAN	0 Hz to 3 GHz	0800.8515.72
PC 3.5 mm	R&S®ZV-Z32	0 Hz to 26.5 GHz	1128.3501.02
PC 3.5 mm (incl. sliding matches)	R&S®ZV-Z33	0 Hz to 26.5 GHz	1128.3518.02
TRL add-on N 50 Ω	R&S®ZV-Z26	0.2 GHz to 18 GHz	1085.7318.02
TRL add-on PC 3.5 mm	R&S®ZV-Z27	0.4 GHz to 26.5 GHz	1085.7401.02

¹⁾ Accessories supplied: operating manual on CD-ROM, quick start guide.

²⁾ Maximum of 2 step attenuators possible per instrument.

³⁾ One cable.

Designation	Type	Frequency range	Order No.
Automatic Calibration Units			
4 ports, type N (f)	R&S®ZV-Z51	300 kHz to 8 GHz	1164.0515.70
4 ports, PC 3.5 mm (f)	R&S®ZV-Z51	300 kHz to 8 GHz	1164.0515.30
2 ports, type N (f)	R&S®ZV-Z53	300 kHz to 18 GHz	1164.0473.32
4 ports, PC 3.5 mm (f)	R&S®ZV-Z52	10 MHz to 24 GHz	1164.0521.30
Sliding Matches			
N (m), 50 Ω	R&S®ZV-Z41	1.7 GHz to 18 GHz	1085.8095.02
N (f), 50 Ω	R&S®ZV-Z41	1.7 GHz to 18 GHz	1085.8095.03
PC 3.5 mm (m/f pair)	R&S®ZV-Z42	2 GHz to 26.5 GHz	1128.3524.02
Hardware and Measurement Add-Ons			
USB-to-IEC/IEEE Adapter (includes VISA I/O driver library)	R&S®ZVAB-B44		1302.5544.02
Visa I/O Library for instrument control	VISA I/O BIB		1161.8473.02
Removable Flash Disk	R&S®ZVAB-B18		1164.0715.03
2nd Removable Flash Disk	R&S®ZVAB-B19		1164.1111.02
Cable for DC Input ⁴⁾ (pair)	R&S®ZV-Z71		1164.1005.02
Bias Network	R&S®ZV-Z61	2 MHz to 4 GHz	1106.8130.02
DC Block	R&S®FSE-Z3	5 MHz to 7 GHz	4010.3895.00
Power Splitter 2 × 50 Ω	R&S®RVZ	0 Hz to 2.7 GHz	0800.6612.52
Attenuators			
1 W	R&S®DNF	0 Hz to 12.4 GHz	0272.4x10.50 ⁵⁾
50 W	R&S®RBU 50	0 Hz to 2 GHz	1073.8695.xx ⁶⁾
100 W	R&S®RBU 100	0 Hz to 2 GHz	1073.8495.xx ⁶⁾
Matching Pads 50 Ω → 75 Ω			
Series resistor	R&S®RAZ	0 Hz to 2.7 GHz	0358.5714.02
L-section	R&S®RAM	0 Hz to 2.7 GHz	0358.6514.02
Miscellaneous			
USB Keyboard	R&S®PSL-Z2		1157.6870.04
USB Mouse	R&S®PSL-Z10		1157.7060.03
19" Rack Adapter with front handles ⁷⁾	R&S®ZZA-511		1096.3290.00
19" Rack Adapter with front handles ⁸⁾	R&S®ZZA-611		1096.3302.00
Operating manual			1145.1084.12

⁴⁾ Mini DIN female to three banana plugs.

⁵⁾ x = 0: 3 dB, x = 1: 6 dB, x = 2: 10 dB, x = 3: 20 dB, x = 4: 30 dB.

⁶⁾ xx = 03: 3 dB, xx = 06: 6 dB, xx = 10: 10 dB, xx = 20: 20 dB, xx = 30: 30 dB.

⁷⁾ For R&S®ZVB4, R&S®ZVB8, R&S®ZVB14 1145.1010.14, R&S®ZVB20 (2 ports) 1145.1010.20.

⁸⁾ For R&S®ZVB14 1145.1010.17, 1145.1010.19, R&S®ZVB20 1145.1010.23, 1145.1010.25.



For data sheet, see PD 0758.1529.22
and www.rohde-schwarz.com
(search term: ZVB)



www.rohde-schwarz.com

Europe: +49 1805 12 4242, customersupport@rohde-schwarz.com
USA and Canada: +1-888-837-8772, customer.support@rsa.rohde-schwarz.com
Asia: +65 65 130 488, customersupport.asia@rohde-schwarz.com