



ABN 43 064 478 842

231 Osborne Avenue Clayton South, VIC 3169
PO Box 1548, Clayton South, VIC 3169
t 03 9265 7400 f 03 9558 0875
freecall 1800 680 680
www.tmgtestequipment.com.au

Test & Measurement

- > sales
- > rentals
- > calibration
- > repair
- > disposal

Complimentary Reference Material

This PDF has been made available as a complimentary service for you to assist in evaluating this model for your testing requirements.

TMG offers a wide range of test equipment solutions, from renting short to long term, buying refurbished and purchasing new. Financing options, such as Financial Rental, and Leasing are also available on application.

TMG will assist if you are unsure whether this model will suit your requirements.

Call TMG if you need to organise repair and/or calibrate your unit.

If you click on the "Click-to-Call" logo below, you can call us for FREE!

TMG Corporate Website

TMG Products Website



Click-to-Call
TMG Now



Product Lifecycle Management System

Disclaimer:

All trademarks appearing within this PDF are trademarks of their respective owners.



User Manual



80E01, 80E02, 80E03, 80E04 & 80E06 Electrical Sampling Modules

071-0434-04

This document applies to firmware version 1.00
and above.

www.tektronix.com

Copyright © Tektronix, Inc. All rights reserved.

Tektronix products are covered by U.S. and foreign patents, issued and pending. Information in this publication supercedes that in all previously published material. Specifications and price change privileges reserved.

Tektronix, Inc., P.O. Box 500, Beaverton, OR 97077-0001

TEKTRONIX and TEK are registered trademarks of Tektronix, Inc.

WARRANTY

Tektronix warrants that the products that it manufactures and sells will be free from defects in materials and workmanship for a period of one (1) year from the date of shipment. If a product proves defective during this warranty period, Tektronix, at its option, either will repair the defective product without charge for parts and labor, or will provide a replacement in exchange for the defective product.

In order to obtain service under this warranty, Customer must notify Tektronix of the defect before the expiration of the warranty period and make suitable arrangements for the performance of service. Customer shall be responsible for packaging and shipping the defective product to the service center designated by Tektronix, with shipping charges prepaid. Tektronix shall pay for the return of the product to Customer if the shipment is to a location within the country in which the Tektronix service center is located. Customer shall be responsible for paying all shipping charges, duties, taxes, and any other charges for products returned to any other locations.

This warranty shall not apply to any defect, failure or damage caused by improper use or improper or inadequate maintenance and care. Tektronix shall not be obligated to furnish service under this warranty a) to repair damage resulting from attempts by personnel other than Tektronix representatives to install, repair or service the product; b) to repair damage resulting from improper use or connection to incompatible equipment; c) to repair any damage or malfunction caused by the use of non-Tektronix supplies; or d) to service a product that has been modified or integrated with other products when the effect of such modification or integration increases the time or difficulty of servicing the product.

THIS WARRANTY IS GIVEN BY TEKTRONIX IN LIEU OF ANY OTHER WARRANTIES, EXPRESS OR IMPLIED. TEKTRONIX AND ITS VENDORS DISCLAIM ANY IMPLIED WARRANTIES OF MERCHANTABILITY OR FITNESS FOR A PARTICULAR PURPOSE. TEKTRONIX' RESPONSIBILITY TO REPAIR OR REPLACE DEFECTIVE PRODUCTS IS THE SOLE AND EXCLUSIVE REMEDY PROVIDED TO THE CUSTOMER FOR BREACH OF THIS WARRANTY. TEKTRONIX AND ITS VENDORS WILL NOT BE LIABLE FOR ANY INDIRECT, SPECIAL, INCIDENTAL, OR CONSEQUENTIAL DAMAGES IRRESPECTIVE OF WHETHER TEKTRONIX OR THE VENDOR HAS ADVANCE NOTICE OF THE POSSIBILITY OF SUCH DAMAGES.

Table of Contents

General Safety Summary	iii
Preface	v
Manual Structure	v
Related Manuals	v
Contacting Tektronix	vi
Getting Started	1
Product Description	2
Options and Accessories	4
Options	4
Standard Accessories	4
Optional Accessories	4
Installation	6
Electrostatic Discharge	6
Static Controlled Workstation	7
Module Installation	8
Compensation	8
Operating Basics	11
Usage	11
Front-Panel Controls	12
Signal Connector	12
Channel Selection	12
TEKPROBE Connector	13
TDR On Indicator	13
System Interaction	13
Commands From the Main Instrument Front Panel	13
Programmer Interface Commands	14
User Adjustments	14
Cleaning	14
Reference	17
Taking TDR Measurements	17
TDR Measurements Background	27
Finding the Velocity of Propagation and Locating Mismatches	30
TDR Measurement Units	30
Making Accurate TDR Measurements	32
Taking Differential and Common-Mode TDR Measurements	32
Connector and Adapter Care Requirements	38
Visual Inspection	38
Cleaning Connectors	39
Assembly and Torquing	41
TDR Impedance Measuring	43
Detecting Blown Inputs	43
EOS (Electrical Overstress) Prevention	44
Specifications	47
Glossary	53
Index	55

List of Figures

Figure 1: Sampling module block diagram	3
Figure 2: Sampling module, 80E04 shown	3
Figure 3: Sampling module compartments	6
Figure 4: Installing a sampling module	8
Figure 5: Sampling module, 80E04 shown	12
Figure 6: Vertical Setup dialog box	14
Figure 7: Simplified schematic diagram of step generator - positive polarity	18
Figure 8: Step generator with a shorted output	19
Figure 9: Step generation with a 50 Ω load	19
Figure 10: Step generation with an open circuit	19
Figure 11: TDR displays for typical loads	21
Figure 12: Microstrip discontinuities	27
Figure 13: TDR waveform of microstrip in Figure 12	28
Figure 14: TDR step and reflection (short)	29
Figure 15: TDR step and reflection (50 Ω line terminated in 75 Ω)	31
Figure 16: TDR step of undamaged sampling module	44
Figure 17: First example of EOS error	45
Figure 18: Second example of EOS error showing cumulative effect	46

List of Tables

Table 1: Application software version required	1
Table 2: Sampling module features	2
Table 3: Standard accessories	4
Table 4: Optional accessories	4
Table 5: Torque Wrench Information	42
Table 6: Electrical sampling modules - Descriptions	47
Table 7: Electrical sampling modules - Signal acquisition	48
Table 8: Electrical sampling module (80E04) - TDR system	50
Table 9: Electrical sampling modules - Timebase system	51
Table 10: Electrical sampling modules - Power consumption	51
Table 11: Electrical sampling modules - Mechanical	52

General Safety Summary

Review the following safety precautions to avoid injury and prevent damage to this product or any products connected to it. To avoid potential hazards, use this product only as specified.

Only qualified personnel should perform service procedures.

While using this product, you may need to access other parts of the system. Read the *General Safety Summary* in other system manuals for warnings and cautions related to operating the system.

To Avoid Fire or Personal Injury

Ground the Product. This product is indirectly grounded through the grounding conductor of the mainframe power cord. To avoid electric shock, the grounding conductor must be connected to earth ground. Before making connections to the input or output terminals of the product, ensure that the product is properly grounded.

Observe All Terminal Ratings. To avoid fire or shock hazard, observe all ratings and markings on the product. Consult the product manual for further ratings information before making connections to the product.

Do Not Operate Without Covers. Do not operate this product with covers or panels removed.

Avoid Exposed Circuitry. Do not touch exposed connections and components when power is present.

Wear Eye Protection. Wear eye protection if exposure to high-intensity rays or laser radiation exists.

Do Not Operate With Suspected Failures. If you suspect there is damage to this product, have it inspected by qualified service personnel.

Do Not Operate in Wet/Damp Conditions.

Do Not Operate in an Explosive Atmosphere.

Keep Product Surfaces Clean and Dry.

Symbols and Terms

Terms in this Manual. These terms may appear in this manual:



WARNING. *Warning statements identify conditions or practices that could result in injury or loss of life.*



CAUTION. *Caution statements identify conditions or practices that could result in damage to this product or other property.*

Terms on the Product. These terms may appear on the product:

DANGER indicates an injury hazard immediately accessible as you read the marking.

WARNING indicates an injury hazard not immediately accessible as you read the marking.

CAUTION indicates a hazard to property including the product.

Symbols on the Product. The following symbols may appear on the product:



Preface

This is the user manual for the 80E01, 80E02, 80E03, 80E04, and 80E06 sampling modules. It covers the following information:

- Description of the capabilities of the sampling modules and how to install them
- Explanation of how to operate the sampling modules: how to control acquisition, processing, and input/output of information
- List of the specifications of the sampling modules

You may want to visit the Tektronix Website at <http://www.tektronix.com> for the latest revision of the user documentation. Select the Manuals link, then enter the part number or product name to locate the document.

A printed version of this manual is also orderable (see *Optional Accessories* on page 4).

Manual Structure

This manual is composed of the following chapters:

- *Getting Started* shows you how to configure and install your sampling module.
- *Operating Basics* describes controlling the sampling module using the front panel and the instrument user interface.
- *Reference* provides additional information including the specifications; detailed descriptions of all programming commands are found in the *CSA8000 & TDS8000 Programmer Guide*.

Related Manuals

This document covers installation and usage of the sampling module and its features. For information of the main instrument in which the sampling module is used, refer to the user documents and online help provided with your 8000-series main instrument.

Contacting Tektronix

Phone	1-800-833-9200*
Address	Tektronix, Inc. Department or name (if known) 14200 SW Karl Braun Drive P.O. Box 500 Beaverton, OR 97077 USA
Web site	www.tektronix.com
Sales support	1-800-833-9200, select option 1*
Service support	1-800-833-9200, select option 2*
Technical support	Email: support@tektronix.com 6:00 a.m. - 5:00 p.m. Pacific time

* **This phone number is toll free in North America. After office hours, please leave a voice mail message. Outside North America, contact a Tektronix sales office or distributor; see the Tektronix web site for a list of offices.**

Getting Started

The Tektronix 80E01, 80E02, 80E03, 80E04, and 80E06 sampling modules are high-performance sampling modules that can be installed in CSA8000 and CSA8000B Communications Signal Analyzer and TDS8000 and TDS8000B Digital Sampling Oscilloscopes.

Proper operation of the electrical sampling modules requires that the appropriate TDS8000 and CSA8000 application software is installed on the main instrument. Table 1 lists the application software versions and the electrical modules supported.

To display the version installed, select *About TDS/CSA8000* from the Help menu of the main instrument.

Table 1: Application software version required

TDS/CSA8000 application software version	Modules supported
1.0.0 or greater ¹	80E01, 80E02, 80E03, 80E04
1.4.0 or greater ¹	80E06
2.0.0 or greater ²	Supports all currently available modules

¹ **Product application software version 1.x.x requires the Windows 98 operating system.**

² **Product application software version 2.x.x requires the Windows 2000 operating system.**

Product Description

The sampling modules provide the features shown in Table 2.

Table 2: Sampling module features

Feature	80E01	80E02	80E03	80E04	80E06
Number of independent channels	1	2	2	2	1
Rise time	7 ps, typical ¹	≤ 28 ps	≤ 17.5 ps	≤ 17.5 ps	≤ 5.0 ps, typical ¹
Typical bandwidth	50 GHz	12.5 GHz, typical	20 GHz, typical	20 GHz, typical	70 GHz, typical
Displayed noise ³	≤ 2.3 mV _{RMS}	≤ 800 μV _{RMS}	≤ 1.2 mV _{RMS}	≤ 1.2 mV _{RMS}	≤ 2.8 mV _{RMS}
Select channel buttons for quick trace identification	Yes	Yes	Yes	Yes	Yes
Maximum non-destructive input voltage	2 V (DC + peak AC)	3 V (DC + peak AC)	3 V (DC + peak AC)	3 V (DC + peak AC)	2 V (DC + peak AC)
Vertical sensitivity, full scale	10 mV to 1 V	10 mV to 1 V	10 mV to 1 V	10 mV to 1 V	10 mV to 1 V
Signal connectors ²	2.4 mm male to 2.92 mm (K) female	3.5 mm female	3.5 mm female	3.5 mm female	2.4 mm male to 2.92 mm (K) female ⁴
Number of TDR channels	N.A.	N.A.	N.A.	2	1

¹ The 80E01 module risetime is estimated using the formula $\text{risetime} = 0.35/\text{bandwidth}$. The 80E06 module risetime is estimated using the formula $\text{risetime} = 0.35/(\text{typical bandwidth})$.

² 3.5 mm female to 2.4 mm male adapter is provided.

³ Measured at 1 ps/div.

⁴ Because the 2.4 mm connector of this adapter will mechanically interface with the 1.85 mm connector of the 80E06, it serves as a 1.85 mm-to-2.92 mm connector for the 80E06 module.

As shown in Figure 1, the sampling modules have two independent channels (80E01 and 80E06 each have one channel), each with its own acquisition circuitry.

The strobe drive signal from the instrument controls the timing of the strobe assertion to each acquisition system and guarantees sampling coincidence between the channels in a sampling module.



CAUTION. To prevent electrostatic damage to the 8000 Series instrument and sampling modules, follow the precautions described in this manual and the manuals accompanying your instrument. (See Electrostatic Discharge on page 6.)

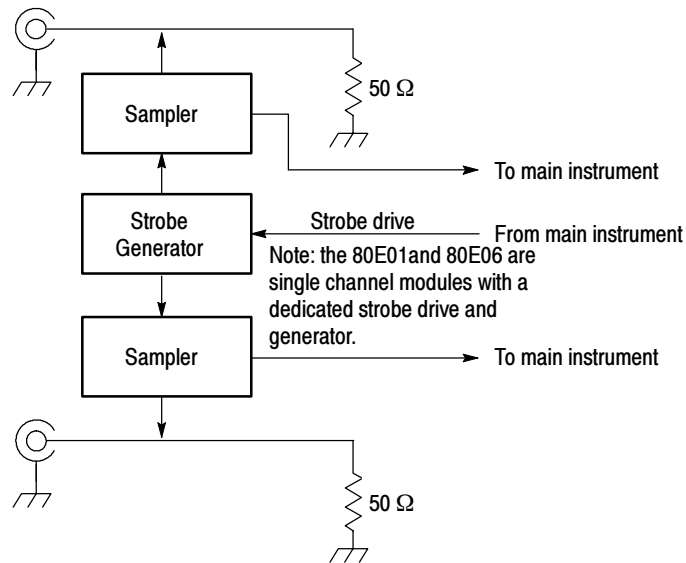

Figure 1: Sampling module block diagram

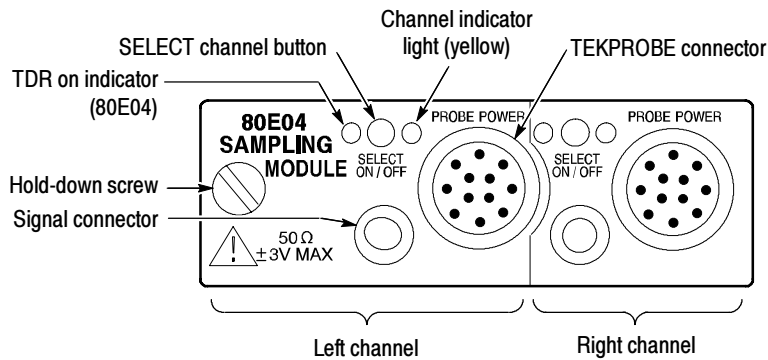

Figure 2: Sampling module, 80E04 shown

Options and Accessories

This section lists the standard and optional accessories available for the sampling modules, as well as the product options.

Options The following options can be ordered for the instrument:

- Option C3: Three years of calibration services
- Option C5: Five years of calibration services
- Option D3: Test Data for calibration services in Option C3
- Option D5: Test Data for calibration services in Option C5
- Option R3: Repair warranty extended to cover three years
- Option R5: Repair warranty extended to cover five years

Standard Accessories The following accessories in Table 3 are shipped with the instrument.

Table 3: Standard accessories

Item	Part number
Certificate of Traceable Calibration for product at initial shipment	Not Orderable
2.4 mm male to 2.92 mm (K) female adapter (80E01 and 80E06 only) ¹	015-0703-xx
SMA male 50 Ω termination (one per channel)	015-1022-xx
Transit case, ESD protective	004-5091-xx
Transit case, ESD protective (80E06 only)	004-5165-xx

¹ **Because the 2.4 mm connector of this adapter will mechanically interface with the 1.85 mm connector of the 80E06, it serves as a 1.85 mm-to-2.92 mm connector for the 80E06 module**

Optional Accessories The following accessories in Table 4 are orderable for use with the sampling module at the time this manual originally published. Consult a current Tektronix catalog for additions, changes, and details.

Table 4: Optional accessories

Item	Part number
Sampling module extender cable (1 meter) ¹	012-1568-xx
Sampling module extender cable (2 meter) ¹	012-1569-xx
2X attenuator (SMA male-to-female)	015-1001-xx

Table 4: Optional accessories (cont.)

Item	Part number
5X attenuator (male-to-female)	015-1002-xx
Power divider	015-0565-xx
SMA accessory kit	020-1693-xx
Torque wrench, 8 mm (5/16 inch) open end	n.a.
3.5 male to 3.5 female SMA	015-0552-xx
Slip-on SMA connector	015-0553-xx
3.5 mm 50 Ω connector (SMA male-to-female)	015-0549-xx
BNC female 75 Ω to 50 Ω type N minimum loss attenuator	131-0112-xx
CSA8000 & TDS8000 Service Manual	071-0438-xx
Terminator, ECL	015-0558-xx
Connector saver, 3.5 mm SMA	015-0549-xx
80E00 Electrical Sampling Module User Manual (printed)	071-0434-xx

¹ **An extender cable extends the reach of a sampling module. You install the extender between the sampling module and the instrument, allowing you to operate the sampling module out of the module compartment. If you compensate a module in the main instrument and then move the module to an extender, or visa versa, re-compensate the module (for more information see *Compensation* on page 8.**

Installation

The sampling modules fit into the front panel of an 8000 Series instrument. Figure 3 shows the front panel of an instrument and the locations of the sampling-module compartments.

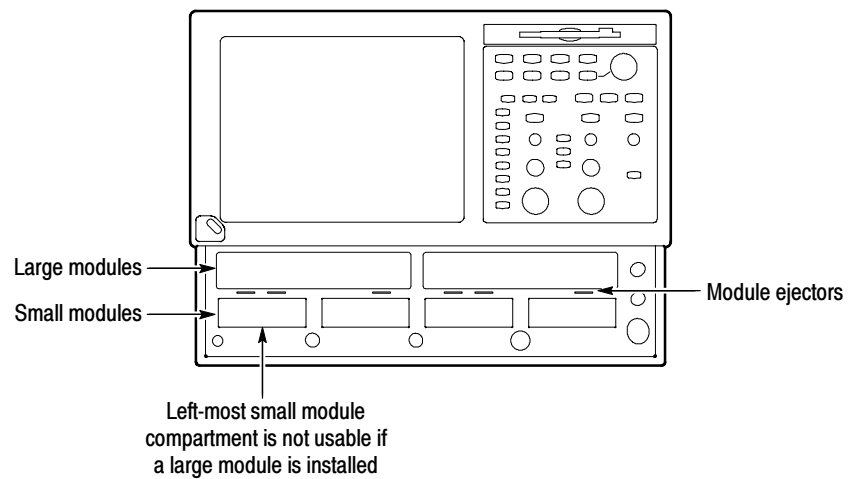

Figure 3: Sampling module compartments

At least one sampling module must be installed in a instrument to sample signals.

NOTE. *Installing a large module disables the left-most small module compartment.*

Each instrument supports two large-compartment channels, one per sampling module, and eight small-compartment channels, two per sampling module. Eight of the ten channels are usable at one time.

Electrostatic Discharge

To prevent electrostatic damage to the 8000 Series instrument and sampling modules, follow the precautions described in this manual and the manuals that come with your instrument.

Circuitry in the sampling module is very susceptible to damage from electrostatic discharge or from overdrive signals. Be sure to only operate the sampling module in a static-controlled environment. Be sure to discharge to ground any electrostatic charge that may be present on the center and outer connectors of cables before attaching the cable to the sampling module.

Know your signal source. If it is capable of delivering overvoltages, it is safer to not depend on the signal source settings for protection, but instead use an

external attenuator that protects the input from the worst-case conditions. For example, for a 20 V maximum source connected to a 3 V maximum sampling module, use a 10X attenuator. Where possible, connect your cables to the signal source first, and to the sampling module second.



CAUTION. *To prevent damage from electrostatic discharge, install 50 Ω terminations on the sampling-module connectors before removing the sampling modules from an instrument or when it is not in use. Store the sampling module in a static-free container, such as the shipping container. Whenever you move the sampling module from one instrument to another, use a static-free container to transport the sampling module.*

To prevent damage to the sampling module, discharge to ground any electrostatic charge that may be present on the center and outer conductors of cables before attaching the cable to the sampling module.

To prevent damage to the sampling module, do not create an ESD antenna by leaving cables attached to the sampling-module input with the other end of the cable open.

To prevent damage to the sampling module or instrument, never install or remove a sampling module when the instrument is powered-on.

Always use a wrist strap (provided with your instrument) when handling sampling modules or making signal connections. Wear anti-static clothing and work in a static-free workstation when using sampling modules.

Use a Tektronix 80A02 EOS/ESD Protection Module if doing TDR work.



To prevent damage to the sampling module or instrument, do not apply a voltage outside the Maximum Input Voltage (see page 48) for your sampling module.

Static Controlled Workstation

For information on creating a static-controlled workstation, consult the Electronic Industries Association document *EIA-625; Requirements for Handling Electrostatic-Discharge-Sensitive (ESDS) Devices*.

You can use a Tektronix 80A02 EOS/ESD Protection Module to protect the sampling module from damage due to static discharge from circuit boards and cables. Use the 80A02 in applications where large static charges can be stored on the device under test, such as when testing TDR circuit boards or cables.

Refer to the documentation supplied with the 80A02 module for proper installation and use.

Module Installation

To install a sampling module, first turn off the instrument using the front-panel On/Standby switch. Then place the sampling module in a compartment and slowly push it in with firm pressure. Once the sampling module is seated, turn the hold-down screw on the sampling module to tighten the sampling module into place. See Figure 4.



CAUTION. To prevent damage to the sampling module or instrument, never install or remove a sampling module when the instrument is powered on or when either input connector is unprotected.

NOTE. When removing your sampling module, first loosen the hold-down screw, and then use the sampling module ejector on the main instrument to eject the sampling module.

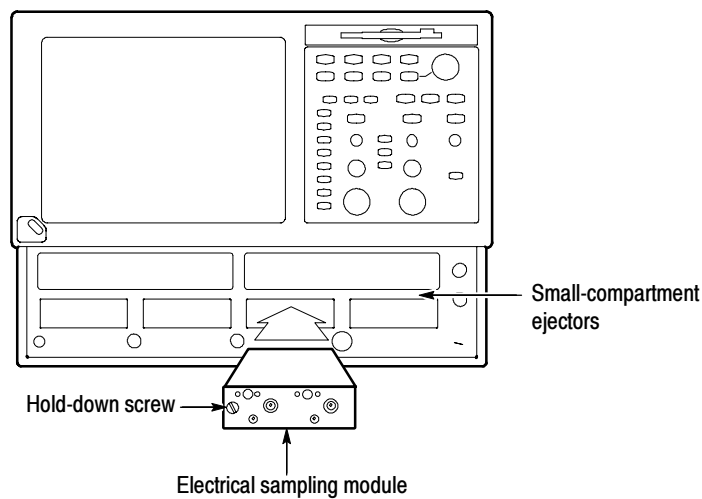

Figure 4: Installing a sampling module

Compensation

After installing a sampling module or after moving a sampling module from one compartment to another, you should run compensation from the Utilities menu to ensure the instrument meets its specifications. Also run a compensation (accessed from the Utilities menu) when doing the following:

- Installing an 80E00 sampling-module extender between the instrument and an 80E00 sampling module, where none was used before
- Removing an 80E00 sampling-module extender between the instrument and an 80E00 sampling module, where one had been used before

- Exchanging an extender for one of a different length

For instructions on running a compensation, see *Optimizing Measurement Accuracy* in your main instrument user manual.

Operating Basics

This chapter makes you familiar with the operation of your sampling module. It describes the front-panel controls and connectors, interaction of the sampling module with your instrument, programming the sampling module, and user adjustments.

Usage

Figure 5 shows the front panel of the sampling module and identifies the buttons, lights, and connectors.



CAUTION. *To prevent damage to your sampling module or instrument, do not apply a voltage outside the Maximum Input Voltage (see page 48) for your sampling module.*

To prevent electrostatic damage to the instrument and sampling modules, follow the precautions described in this manual and the manuals accompanying your instrument. (See Electrostatic Discharge starting on page 6.)



Always use a wrist strap (provided with your instrument) when handling sampling modules or making signal connections.

The input circuitry in your sampling module is very susceptible to damage from overdrive signals and electrostatic discharge. Never apply a DC or peak voltage greater than the Maximum Input Voltage (see page 48) of your sampling module. Only operate the instrument and sampling module in a static-controlled environment.

Front-Panel Controls

Each sampling module contains two identical input channels (80E01 has one channel). This section describes channel controls, connectors, and indicators.

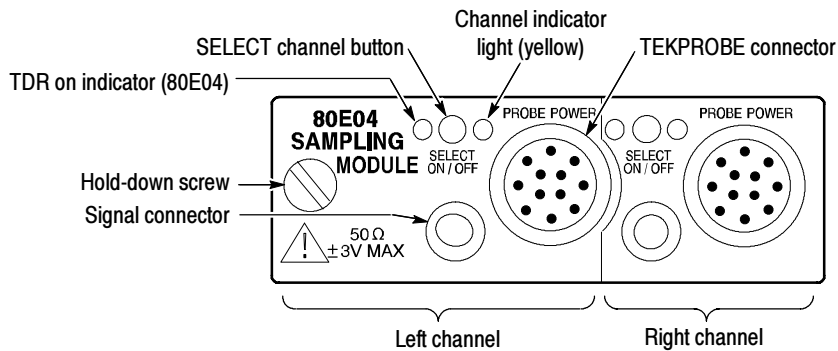

Figure 5: Sampling module, 80E04 shown

Signal Connector

The input signal connectors for each channel let you connect signals that you want to sample. To acquire a signal, connect the signal to the sampling module through the Signal Connector input. Signal connectors used on your sampling module are described in Table 2 on page 2.

Connector Care. Never attach a cable to a sampling-module connector if the cable has a worn or damaged connector because you may damage the sampling-module connector. Use extra care when attaching or removing a cable from the connectors. Turn only the nut, not the cable. When attaching a cable to a sampling-module connector, align the connectors carefully before turning the nut. Use light finger pressure to make this initial connection. Then tighten the nut lightly with a wrench. For more information, see *Connector and Adapter Care Requirements* on page 38. For the specific torque settings, see Table 5 on page 42.

If the sampling-module connectors will receive heavy use, such as in a production environment, you should install adapters (such as a Tektronix part number 015-0549-xx for 3.5 mm connectors) on the sampling module to make connections to the device under test.

Channel Selection

Each channel has a SELECT channel button and a yellow channel light. The button operates as follows:

- If the yellow channel light is on, the channel is acquiring a waveform.

- If you press the button and the channel is not currently being acquired (for any channel or math waveform), then the instrument activates (turns on) the channel.
- If you press the button and the channel is currently active as a channel waveform, then the instrument selects the channel waveform.
- If the channel waveform is already selected when you press the channel button, the instrument turns the channel off.

TEKPROBE Connector

The TEKPROBE connector provides support for accessories requiring TEKPROBE SMA support at levels 1 and 2. The connector provides power and control to attached accessories, by the main instrument.

TDR On Indicator

On modules with TDR capability, the red TDR ON light indicates whether the step generator is sending out a step through the signal connector. The main instrument turns this on or off.

System Interaction

Your sampling module is a part of a larger instrument system. Most of the sampling-module functions, such as vertical and horizontal scale, are controlled automatically by the main instrument. You do not directly control these parameters; they are controlled for you as you perform tasks on the main instrument. The parameters that you control from the sampling module front panel are covered in *Front-Panel Controls* on page 12.

You also control external channel attenuation from the main instrument. External Attenuation enables you to enter a number representing external attenuation you have added to a channel.

Commands From the Main Instrument Front Panel

The Vertical Setup dialog box accesses the sampling module controls. This dialog box is shown in Figure 6.

You first select the channel in the Waveform section of the dialog box. Then you select the Setup Scale, Position, Channel Offset, Deskew, Units, or External Attenuation boxes to change those settings.

Detailed information on this dialog box can be found in the online help accessed from the main instrument.

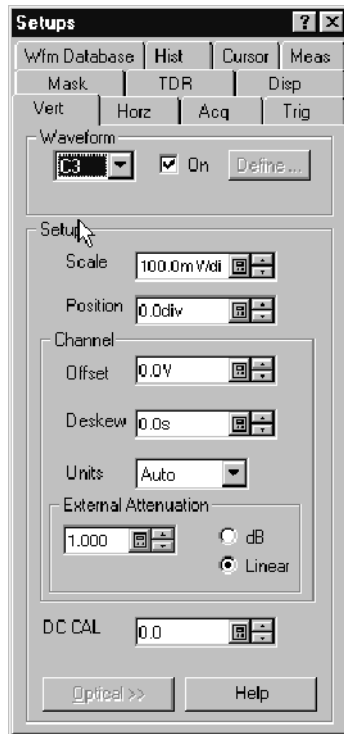

Figure 6: Vertical Setup dialog box

Programmer Interface Commands

The remote-programming commands for all sampling module are documented in the *CSA8000 & TDS8000 Programmer Guide*.

User Adjustments

All sampling module setups, parameters, and adjustments are controlled by the main instrument. To save, recall, or change any module settings, use the instrument menus or front-panel controls or consult the online help accessed from the main instrument.

Cleaning

The case of the module keeps dust out and should not be opened. Cleaning the exterior of the module is usually confined to the front panel. If you desire to clean the case, remove the module from the main instrument but first read the entire *Installation* procedure starting on page 6 for proper handling of the module.



WARNING. *To prevent injury, power down the instrument and disconnect it from line voltage before performing any cleaning.*

Clean the exterior surfaces of the module with a dry lint-free cloth or a soft-bristle brush. If any dirt remains, use a damp cloth or swab dipped in a 75% isopropyl alcohol solution. Use a swab to clean narrow spaces around controls and connectors. Do not allow moisture inside the module. Do not use abrasive compounds on any part of the chassis that may damage the chassis.



CAUTION. *To prevent damage, avoid the use of chemical cleaning agents which might damage the plastics used in this instrument. Use only deionized water when cleaning the menu buttons or front-panel buttons. Use a 75% isopropyl alcohol solution as a cleaner, and rinse with deionized water. Before using any other type of cleaner, consult your Tektronix Service Center or representative.*

Do not open the case of the module. There are no user serviceable components and cleaning the interior is not required.

Reference

This chapter contains the following sections:

- *Taking TDR Measurements* describes how to use the 80E04 sampling module to perform time-domain-reflectometry (TDR) measurements.
- *TDR Measurements Background* contains information that describes the cause of reflections, measurement range, the velocity of propagation and measuring mismatches, measurement units, and considerations for making accurate measurements.
- *Taking Differential and Common-Mode TDR Measurements* describes how to use the 80E04 sampling module to perform differential and common-mode TDR measurements.
- *Connector and Adapter Care Requirements* describes proper care and use of the 80E06 connector and adapter, including protection against electrostatic discharge (ESD), cleaning connectors, and the assembly and torquing of connectors.
- *TDR Impedance Measuring* describes the stand-alone application that implements the TDR calibration procedure(s) specified by the IPC-TM-650 test methodology.
- *Detecting Blown Inputs* describes how to check for damage on an 80E04 sampling module or a non-TDR sampling module.
- *EOS (Electrical Overstress) Prevention* describes the causes, how to prevent EOS, and how to check for damage.

Taking TDR Measurements

This section describes how to use the 80E04 to perform TDR measurements.

Why Use? To take TDR measurements on transmission lines. Using TDR you can measure the impedance along a transmission line and determine the distance to an impedance change.

What's Special? Vertical can be scaled in volts, rho, or ohms units.

What's Excluded? This feature only works with a 80E04 sampling module.

Keys to Using

Read the following topics; they provide details that can help you set up and take effective TDR measurements.

TDR Step Generation. Both channels in the 80E04 TDR/sampling module have a selectable polarity step generator which gives both channels measurement capabilities. You can use the outputs of both generators to perform differential and common-mode TDR measurements.

The step generator circuitry consists, fundamentally, of a polarity-selectable current source and a diode switch. Initially, before the step, the diode switch is biased to conduct current to the output. When the diode switch opens, the step occurs. A DC current source assures that the baseline level stays close to zero volts. Figure 7, a simplified diagram, shows the switch and the current source.

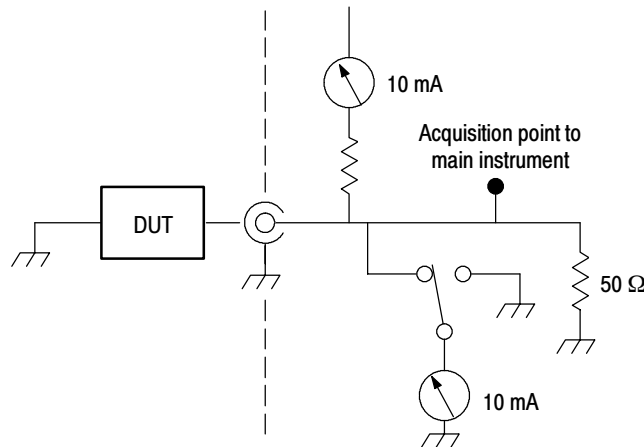

Figure 7: Simplified schematic diagram of step generator - positive polarity

The following sections and figures 8-10 describe the operation with a short circuit, an open circuit, and a $50\ \Omega$ load, with a positive step source.

Operation Into a Short. Initially, the diode switch is conducting $-10\ \text{mA}$. Since the step-generator output is initially shorted, the resistance to ground is $0\ \Omega$.

When the diode switch opens (reverse-biased), apparent resistance to ground at the acquisition point (and at the channel connector) is $25\ \Omega$ because the internal termination resistance is $50\ \Omega$ in parallel with the connector impedance of $50\ \Omega$. The voltage at the acquisition point rises to $+250\ \text{mV}$, the incident amplitude E_i .

The transition propagates to the short in the Device Under Test (DUT) and is negatively reflected back to the acquisition point, $E_r = -250\ \text{mV}$ reflected, causing the voltage at the acquisition point to drop back to $0\ \text{V}$. The time displayed from the first transition to the second transition is the round trip

propagation time from the acquisition point to the short in the device under test and back. See Figure 8.

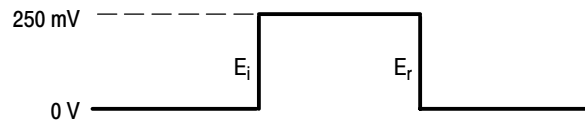

Figure 8: Step generator with a shorted output

Operation Into a 50 Ω Load. Initially, the diode switch is conducting -10 mA. Since the step-generator output is connected to a 50 Ω load, the resistance to ground at the acquisition point is 25 Ω (because of the internal 50 Ω impedance).

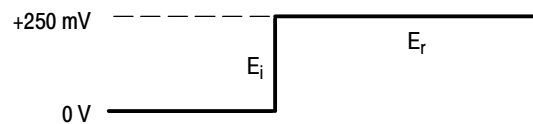

Figure 9: Step generation with a 50 Ω load

When the diode switch opens (reverse-biased), apparent resistance to ground at the acquisition point (and at the channel connector) is 25 Ω because the internal termination resistance is 50 Ω in parallel with the connector impedance of 50 Ω . The voltage at the acquisition point rises to +250 mV.

The transition propagates to the 50 Ω load and no reflection occurs.

Operation Into an Open. Initially, the diode switch is conducting -10 mA. Since the step-generator output is open, the resistance to ground at the acquisition point is 50 Ω (because of the internal 50 Ω impedance).

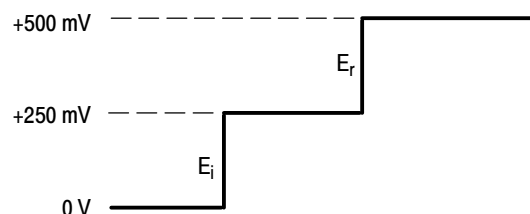

Figure 10: Step generation with an open circuit

When the diode switch opens (reverse-biased), apparent resistance to ground at the acquisition point (and at the channel connector) is $25\ \Omega$ because the internal termination resistance is $50\ \Omega$ in parallel with the connector impedance of $50\ \Omega$. The voltage at the acquisition point rises to +250 mV.

The transition propagates to the open in the DUT and is positively reflected back to the acquisition point, causing the voltage at the acquisition point to rise to +500 mV. At the acquisition point, the time displayed from the first step to the second step is the round trip propagation time from the acquisition point to the open in the DUT and back. See Figure 10.

Baseline Correction. The baseline of a current-source based step generator normally shifts its DC level with loading. The use of a DC current source to cancel the step source current maintains the baseline level close to 0 V (see Figure 7 on page 18).

Shape of Reflections. The shape of a reflection reveals the nature and magnitude of the load impedance, mismatch, or fault, even when the load impedance is not a short, $50\ \Omega$, or open. Figure 11 shows typical TDR displays and the load that generated the reflection.

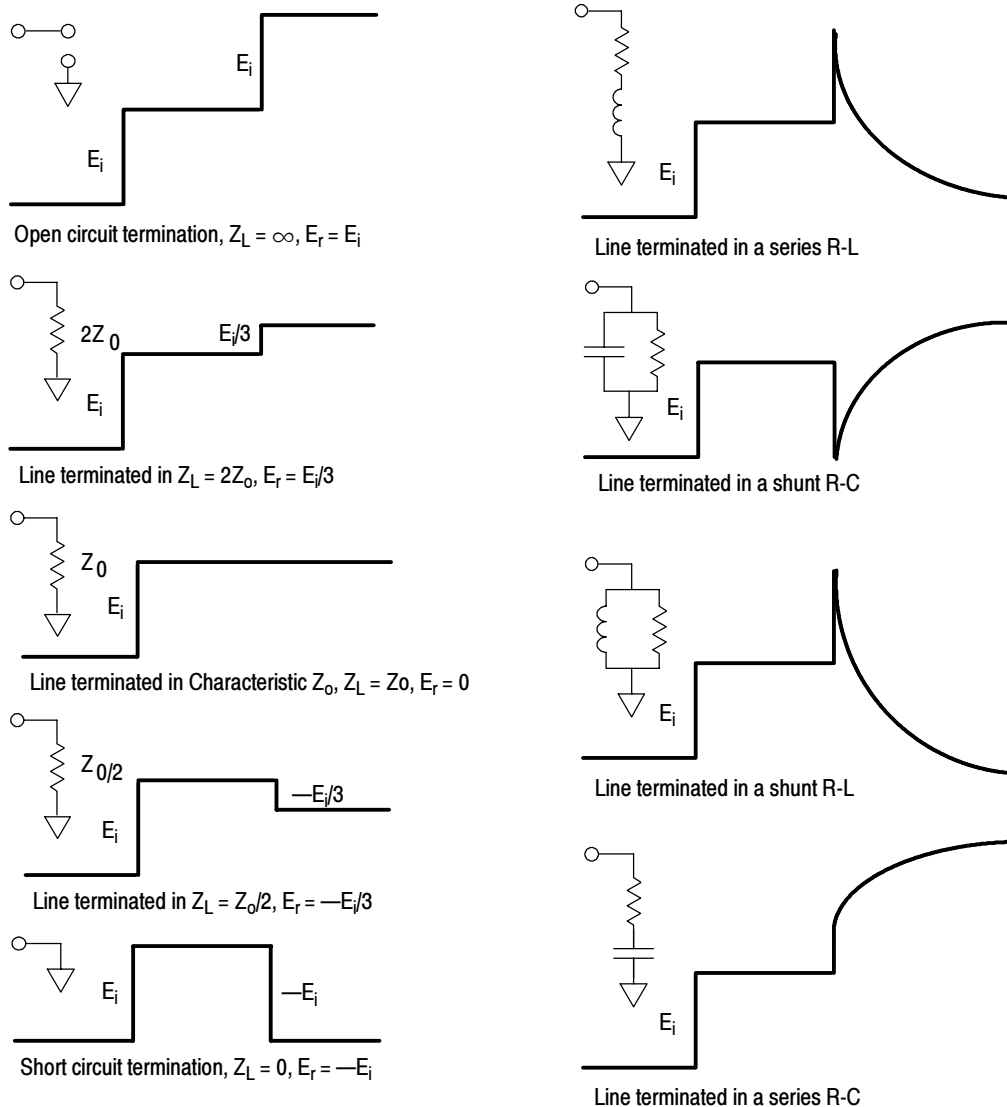
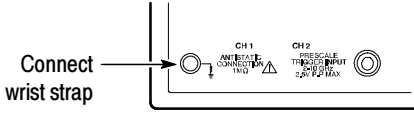
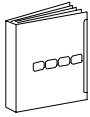
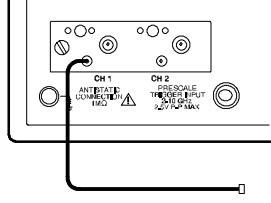
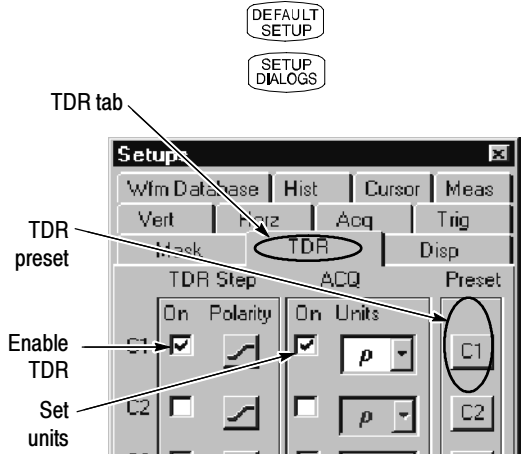
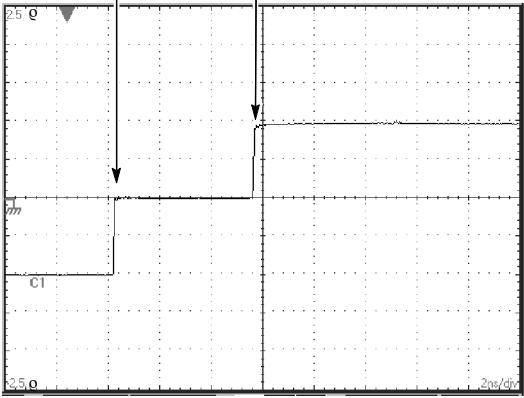
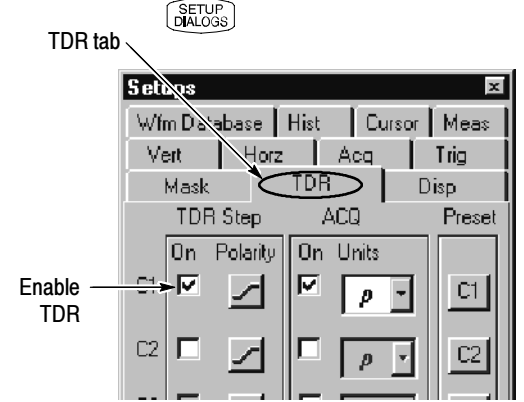

Figure 11: TDR displays for typical loads

To Take a TDR Measurement

This example demonstrates the TDR feature of the 80E04 sampling module. TDR is a method of examining and measuring a network or transmission line by sending a step into the network and monitoring the reflections.

Overview	To take a TDR measurement	Control elements & resources
<p>Prerequisites</p>	<ol style="list-style-type: none"> 1. Connect your wrist strap to the antistatic connector on the front of your instrument. See <i>Caution</i> on page 7. 2. An 80E04 sampling module must be installed in the main instrument. The Acquisition system should be set to Run, and the vertical and horizontal controls should be set appropriately for the signal to be acquired. 	 <p>Connect wrist strap</p>  <p>See the main instrument user documentation for scaling and acquisition setup</p>
<p>Input</p>	<ol style="list-style-type: none"> 3. Connect the transmission line to the sampling module using proper probing/connecting techniques for your application (for example: connect an SMA cable, of < 5 ns length). 	
<p>Preset TDR</p>	<ol style="list-style-type: none"> 4. Initialize the instrument (press DEFAULT SETUP). 5. Press the SETUP DIALOGS button and select the TDR tab. 6. Press TDR Preset for the appropriate channel. <p>TDR Preset sets Internal Clock in the Trigger menu, turns on the TDR Step in the TDR Setups menu, turns on the channel and selects the acquisition Units in the TDR Setups menu, and sets the horizontal scale, position, and reference.</p> <p>The sampling module will turn on a red light next to the SELECT channel button, indicating that TDR is activated for that channel. You can use TDR on each channel independently.</p>	 <p>DEFAULT SETUP</p> <p>SETUP DIALOGS</p> <p>TDR tab</p> <p>TDR preset</p> <p>Enable TDR</p> <p>Set units</p>

Overview	To take a TDR measurement (cont.)	Control elements & resources
<p>Set other TDR parameters</p>	<p>7. Adjust the VERTICAL SCALE (500 mΩ/div in this example) and HORIZONTAL SCALE (2 ns/div in this example) to show a trace similar to that shown. Leave at least one division of baseline trace to the left of the first rise.</p> <p>The first rise of this waveform is the incident TDR step leaving the sampling module; the second rise is the reflection of the step returning from the end of the cable.</p> <p>For your device under test (DUT), you may need to adjust the Horizontal SCALE, POSITION, and Reference to display the reflections from your DUT near the left of the graticule.</p> <p>To locate reflections from your DUT, disconnect your probe or cable at the DUT and look for the reflection from the open end of the probe or cable.</p> <p>Assuming the line to be tested is an open-end microstrip on a circuit board and that you probe or cable is now connected to the line, you will see the new open reflection to the right according to the length of the line. There may be a visible disturbance where the connections is made to the board (for example see Figure 12 on page 27). The area between the entry to the board and the open reflection at the end of the board is the target area for your TDR measurements. Adjust Vertical SCALE, Vertical POSITION, Horizontal SCALE, and Horizontal POSITION as necessary for a good quality display of the measurement area.</p>	
<p>Changing TDR graticule units</p>	<p>8. The units of measure commonly used in TDR are units of rho (Ω), measured on the vertical axis. You can change the measurement units by using the ACQ Units selector in the TDR Setups dialog box.</p> <p>9. Press the SETUP DIALOGS button, and select the TDR tab.</p> <p>10. Select either V for Volts, ρ for rho, or Ω for ohms.</p>	

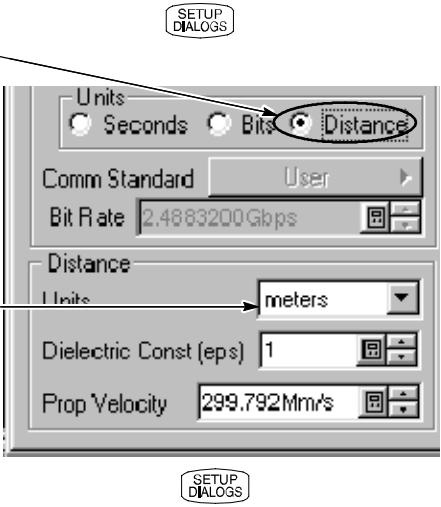
Overview	To take a TDR measurement (cont.)	Control elements & resources
<p>Specifying horizontal timebase units</p>	<ol style="list-style-type: none"> 11. Select the HORIZONTAL tab. 12. Select the Distance radio button. Use this control to specify the type of units to use for the horizontal axis for all timebases. You can select from seconds, bits, or distance. The timebase scale and position controls adopt the units you select. 13. If your application requires it, you can also set either of the following controls (they interact, so set one or the other): <ul style="list-style-type: none"> - Enter a Dielectric Const (eps) value to match that of the device under test. - Enter a Prop Velocity value to match that of the device under test. 14. Press the SETUP DIALOGS button. 15. Continue with the automatic measurement process on the following page. 	 <p>The screenshot shows the 'SETUP DIALOGS' window. At the top, there is a 'SETUP DIALOGS' button. Below it, the 'Units' section has three radio buttons: 'Seconds', 'Bits', and 'Distance'. The 'Distance' radio button is selected and circled. Below the 'Units' section, there is a 'Comm Standard' dropdown menu set to 'User' and a 'Bit Rate' field set to '2.4883200 Gbps'. The 'Distance' section has a 'Units' dropdown menu set to 'meters', a 'Dielectric Const (eps)' field set to '1', and a 'Prop Velocity' field set to '299.792 Mm/s'. There is another 'SETUP DIALOGS' button at the bottom. Two callout lines point to the 'Distance' radio button and the 'meters' dropdown menu, with labels 'Distance button' and 'Type of units' respectively.</p>

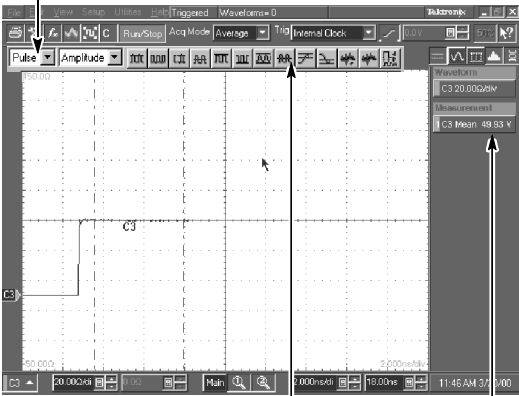
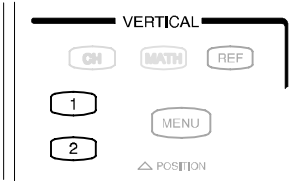
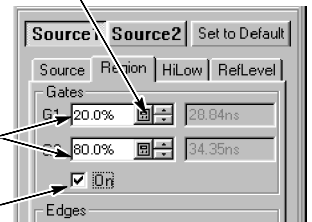
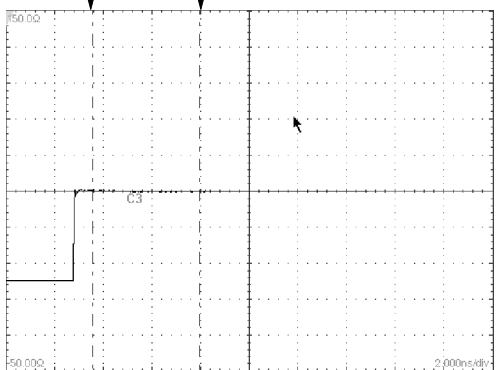
Overview	To take a TDR measurement (cont.)	Control elements & resources
<p>Take automatic measurements</p>	<p>16. Use the Vertical buttons to select the TDR waveform to be measured.</p> <p>17. Select one of the measurement tool bars.</p>  <p>18. Click the measurement you want (such as mean) in the measurement tool bar.</p> <p>19. Read the results in the measurements readout.</p> <p>20. To take your measurement over a portion of the waveform, select the region tab to display the gate controls. Click the check box as indicated at the right to turn gating on and to display the gates on screen.</p> <p>21. Use the G1 (Gate1) and G2 spin controls (or click and type in values, use the keypad or multipurpose knobs, or touch and drag the gate) to adjust the gates on screen such that the area to measure is between the gates.</p> <p>If necessary to provide a good view of this portion of the waveform, adjust the Vertical SCALE and POSITION and the Horizontal SCALE, POSITION, and Reference. To see the difference scale and position can make in your waveform display, compare the waveforms in Figure 15 and also compare the waveforms in figures 12 and 13.</p>	 <p>Access to virtual keyboard</p>  <p>Vary to position gates</p> <p>Check to display gates</p> <p>Gate G1 Gate G2</p> 

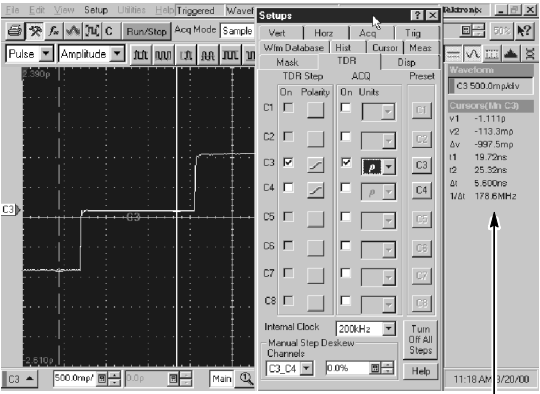
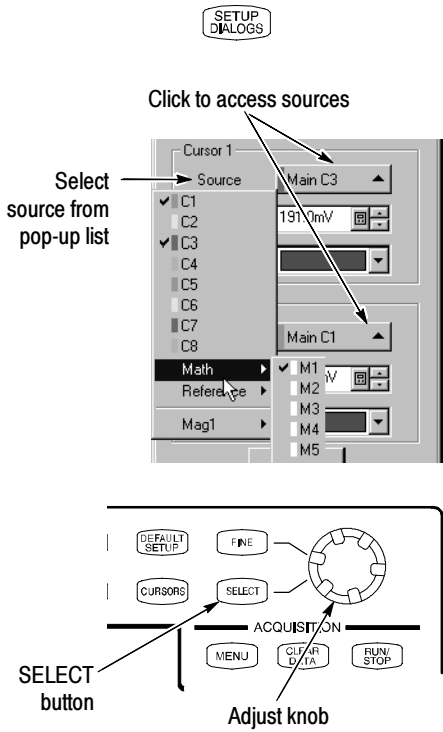
Overview	To take a TDR measurement (cont.)	Control elements & resources
<p>Take cursor measurements</p>	<p>22. Press the SETUP DIALOGS button and select the Cursor tab.</p> <p>23. Select the Waveform cursor type.</p> <p>24. From the pop-up list for each of Cursor 1 and Cursor 2, select your TDR source.</p> <p>25. Press the SELECT button to toggle selection between the two cursors. The active cursor is the solid cursor.</p> <p>26. Turn the Adjust knob to position each cursor on the math waveform to measure the feature that interests you.</p>  <p>27. Read the results in the cursor readout. In the figure shown above, waveform cursors are used to measure Δv and Δt of the waveform, which could be used to compute its slope (dv/dt).</p>	

TDR Measurements Background

TDR is based on a simple concept: Whenever energy transmitted through any medium encounters a change in impedance, some of the energy is reflected back toward the source. The amount of energy reflected is a function of the transmitted energy and the magnitude of the impedance change. The time lapse between energy transmission and the reflection returning is a function of the distance from the source to the impedance discontinuity, and the propagation velocity.

The effects of this phenomenon are evidenced through echoes that occur when sound encounters a wall. In electrical systems, a similar phenomenon occurs when electrical energy traveling in a transmission line encounters a change in impedance. Any change in the impedance of the transmission line, such as a variation in the width of a circuit board trace, causes a reflection with an amplitude related to the magnitude of the impedance change.

A Time Domain Reflectometer sends out a step on the cable, circuit board, or integrated circuit under test. The reflection (or echo) received by the TDR is measured to find events along the path of the step.

Reflections are caused both by events that are expected, such as width changes and components, and by those that shouldn't be there, such as bridges, shorts, and opens. The strength of a TDR measurement is that it not only tells you there is a fault, but it also tells you the magnitude and the distance to that fault.

TDR can note any change in the characteristic impedance of the device-under-test (DUT). Any change in the impedance is shown on the TDR display as an upward bump or downward dip in the waveform, depending on the type of event (see Figure 12 for example discontinuities in a microstrip).

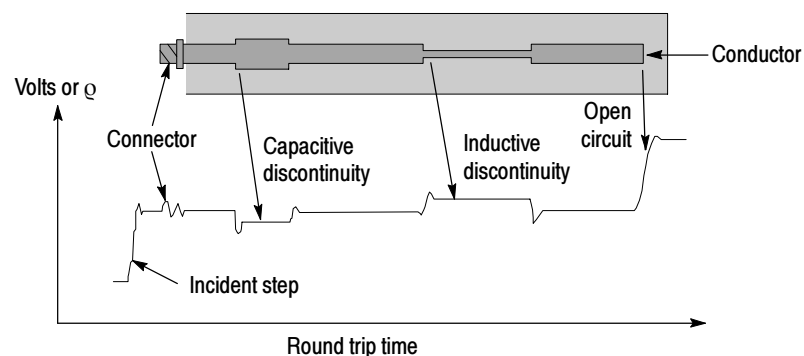

Figure 12: Microstrip discontinuities

Cause of Reflections

The reflections that a TDR displays and measures are caused by changes in the impedance of the path of the step (circuit board, cable, or integrated circuit). Any significant change in impedance will cause a reflection. As an example, if an open solder connection exists on a circuit board, you can see that change with TDR. TDR also displays changes in the conductor resistance. For example, if there is corrosion in a joint and there is high resistance at that point, this is seen by a TDR. TDR also displays changes in capacitance.

If you think of the TDR display in terms of bumps and dips, it tends to make interpretation a lot easier. A bump (upward deflection) indicates a higher-impedance event, such as an open (see Figure 13) or a reduction in line width (see Figure 12). A dip (downward deflection) indicates a lower-impedance event, such as a short (see Figure 14) or an increase in conductor width (see Figure 12). The time location of the high-impedance event or low-impedance event as well as the delta times is displayed on screen.

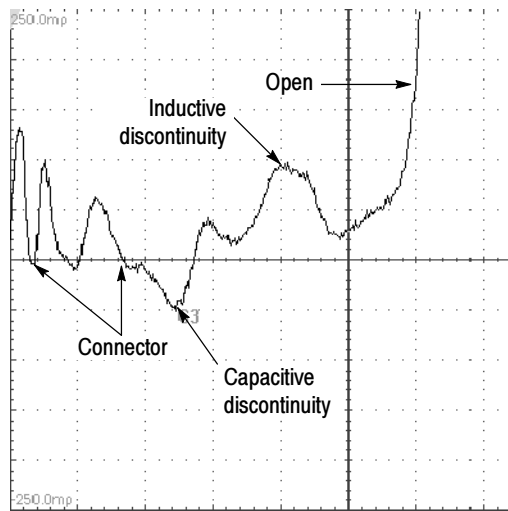

Figure 13: TDR waveform of microstrip in Figure 12

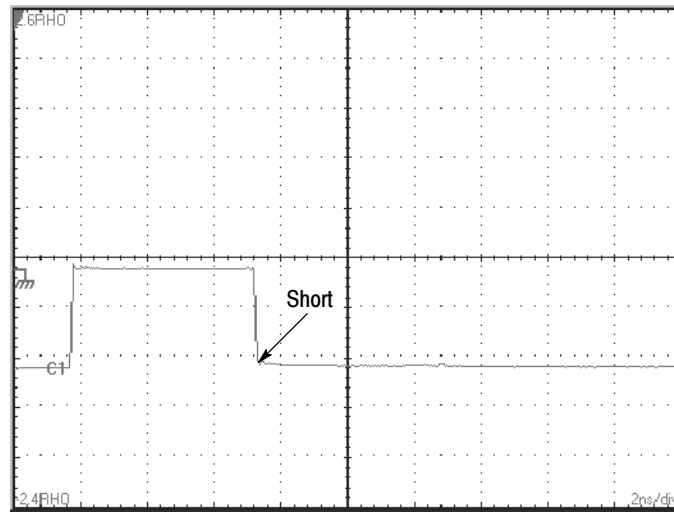

Figure 14: TDR step and reflection (short)

TDR Measurement Range

What is the range of your TDR? is a common question asked by people looking to purchase a TDR. This is a very important question that cannot be answered simply. Another important consideration is how close together the TDR can resolve features. This section discusses TDR range and the factors affecting it.

There are a number of factors that can affect the distance over which a TDR can locate features. The most important parameters that are TDR-related are step amplitude, step risetime, and step width.

Step amplitude is the amount of voltage produced by the TDR step. It is fixed for the 80E04 at 250 mV. In general, the higher the amplitude, the farther the TDR can see. Generally, this type of step is optimized for short range TDR.

Overall step width also affects range. It follows the setting of the Internal Clock Rate (25 kHz - 200 kHz). Step width is measured in time, but can also be thought of as distance when using a TDR. The longer the step width, the greater the range of the TDR. At 200 kHz, the step “on” time is 2.5 us - enough to see in air (one way transit) 375 meters (about 1,250 feet). To see events at greater distances, set the Internal Clock of the TDR to a lower frequency.

Finding the Velocity of Propagation and Locating Mismatches

The time between the incident edge and the reflected edge is valuable in determining the length of the transmission line from the TDR to a mismatch, or between two mismatches. The formula is:

$$D = v_p \times \frac{T}{2} = \frac{v_p T}{2}$$

where: D = distance to the fault

v_p = velocity of propagation

T = the time from the TDR to the mismatch and back again,
as measured on the instrument

Velocity of Propagation (v_p) is a measure of how fast a signal travels in that transmission line.

NOTE. The factor of 2 in the denominator is present because TDR systems display round-trip time (incident and reflected edges), whereas with distance it is usually desirable to display one-way distance. It is important to note that the distance scale does not inject this factor of two, and, therefore, the distance displayed is round-trip. See the main instrument user documentation and online help for more information about distance scale operation.

TDR Measurement Units

All TDR impedance measurements are based on the ratio of transmitted voltage to reflected voltage. As a result, measurements are not generally taken in absolute units, such as volts. Instead, TDR measurements are made on a relative scale, called reflection coefficient and abbreviated as ρ . The definition of ρ is the reflected signal amplitude divided by the incident signal amplitude. For example, if a 100-millivolt reflection results from a 1-volt incident step, the reflection is called a 100 millirho reflection: $\rho = E_{\text{reflected}}/E_{\text{incident}} = 100 \text{ m}\rho = 100 \text{ mV}/1 \text{ V}$. Given a known impedance and a measured reflection coefficient, the unknown impedance that caused the reflection can be calculated from the following equation:

$$\rho = \frac{E_{\text{reflected}}}{E_{\text{incident}}} = \frac{Z_L - Z_o}{Z_L + Z_o}$$

where Z_o is the known impedance, ρ is the measured reflection coefficient, and Z_L is the unknown impedance. An alternate form of the equation is:

$$Z_L = Z_o \left(\frac{1 + \rho}{1 - \rho} \right)$$

Figure 15 shows a typical waveform from a Tektronix TDS oscilloscope or CSA analyzer equipped with an 80E04 TDR/sampling module. In this case, the instrument is connected through a 50 Ω coaxial cable to a 75 Ω device under test. The incident step is about 2 divisions in amplitude, and the reflection from the device under test is about 0.4 division high. These numbers equate to a reflection coefficient of 0.2 ρ (0.4 divisions divided by 2 divisions). Plugging the known 50 Ω level and the reflection coefficient into the above equation yields the 75 Ω value:

$$Z_L = Z_0 \left(\frac{1 + \rho}{1 - \rho} \right)$$

$$Z_L = 50 \left(\frac{1 + 0.2}{1 - 0.2} \right) = 75 \Omega$$

Notice that the instrument automatically performs this calculation and displays the impedance (Ω) or reflection coefficient (ρ) for each cursor and the difference between the two cursors.

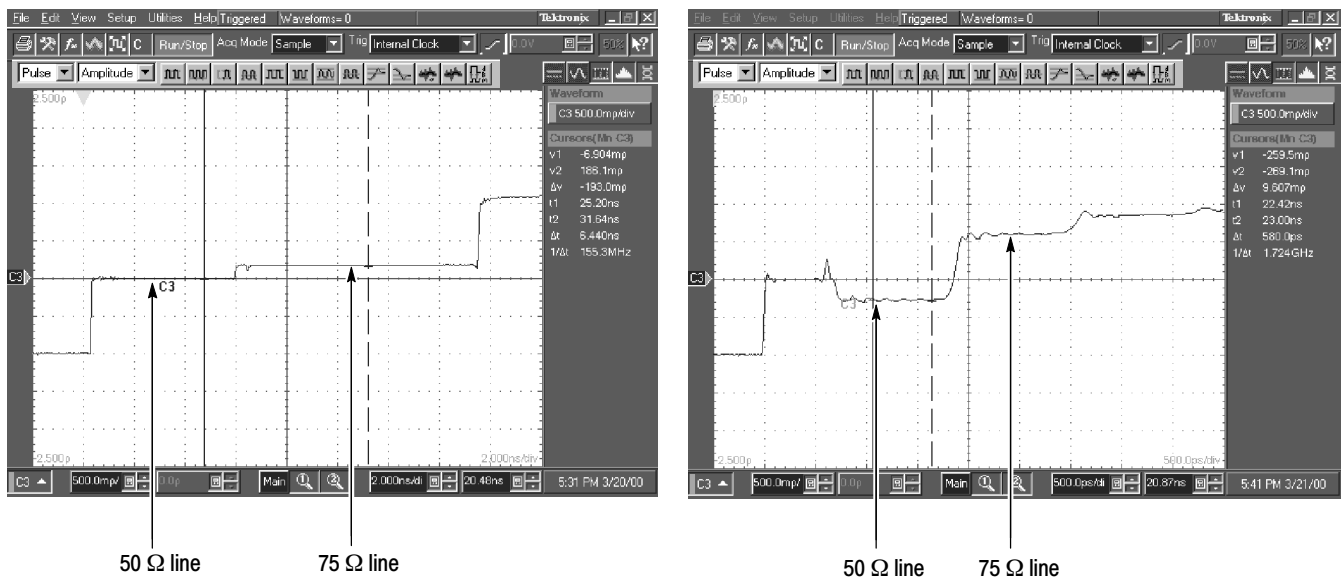

Figure 15: TDR step and reflection (50 Ω line terminated in 75 Ω)

Making Accurate TDR Measurements

A number of issues must be considered to make accurate TDR measurements. In general it is relatively easy to make impedance measurements near the reference impedance (usually 50 Ω). Higher accuracy or measurements farther from the reference impedance requires more care. The following list covers a few key considerations in making accurate and repeatable impedance measurements.

Resolution. Resolution determines the shortest impedance discontinuity that a TDR instrument can measure. Because of round trip effects, Resolution = $1/2(\text{System Reflected Rise Time})$. If a discontinuity, such as a variation in the width of a trace, is small with respect to the system rise time, the reflection will not accurately represent the impedance of the discontinuity. In extreme cases, the discontinuity may effectively disappear. System rise time is the combined rise time of the step generator (TDR), the instrument, and the interconnect between the TDR and the circuit under test. In general, the most significant limitation in impedance testing is the probe. Close attention to probe geometry and probing techniques can greatly enhance resolution.

Reference Impedance. All TDR measurements are relative; they compare an unknown impedance to a known impedance. The accuracy of the results depends directly on the accuracy of the reference impedance. Any error in the reference impedance translates to error in the measured impedance. It is also a good idea to use a reference impedance close to the expected measured impedance because a smaller difference between the reference and unknown impedance reduces uncertainty in the measurement.

Cable Losses. Always use the shortest high-quality cable possible to connect to the test fixture. The cable that connects the TDR unit to the circuit board not only degrades the system rise time, but can cause other aberrations in the system response that add to measurement error.

Taking Differential and Common-Mode TDR Measurements

This section describes how to use the 80E04 to take differential and common-mode time-domain reflectometry (TDR) measurements.

Why Use?

To take TDR measurements on coupled transmission lines. Using common-mode and differential TDR, you can characterize coupled transmission lines.

What's Special?

The Tektronix 80E04 sampling module is a true differential sampling module for more accurate differential TDR measurements.

What's Excluded?

This feature only works with an 80E04 sampling module.

Keys to Using

Read the following topics; they provide details that can help set up to take effective differential and common mode TDR measurements.

The 80E04 TDR/sampling module is able to perform differential and common-mode TDR measurements. As described earlier, the sampling module has two input channels and two independent step generators.

The step-generator output for each channel is selectable for positive or negative polarity and amplitude. This section will show you how to use the two channels and step generators of the 80E04 to perform differential and common-mode TDR measurements.

To Take a Common-Mode or Differential TDR Measurement

This example demonstrates the common-mode and differential TDR features of the 80E04 sampling module.

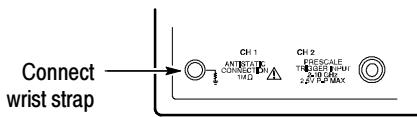
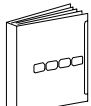
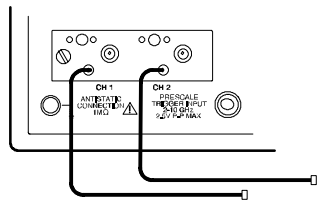
Overview	To take a common mode or differential TDR measurement	Control elements & resources
<p>Prerequisites</p>	<ol style="list-style-type: none"> 1. Connect your wrist strap to the antistatic connector on the front of your instrument. 2. An 80E04 sampling module must be installed in a TDS oscilloscope or CSA analyzer. The acquisition system should be set to Run. 	 <p>Connect wrist strap</p>  <p>See the main instrument user documentaion for scaling and acquisition setup</p>
<p>Input</p>	<ol style="list-style-type: none"> 3. Connect transmission lines to the sampling module using proper probing/connecting techniques for your application (for example: two SMA cables, preferably of matched length). Connect the device under test to the transmission lines (Connect the conductors of a differential line to the center conductors. Connect the shields together.) 	

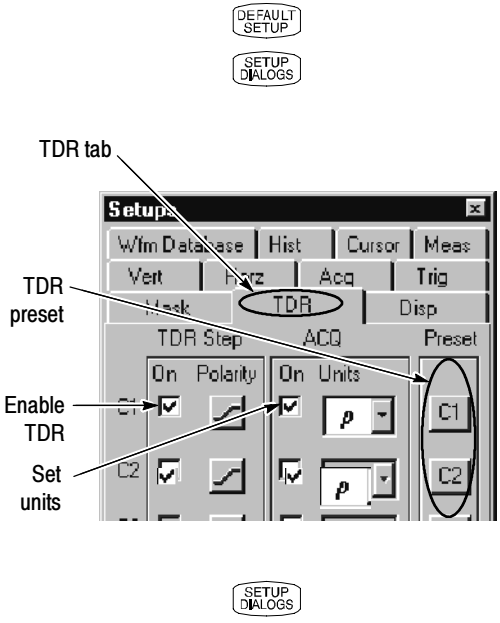
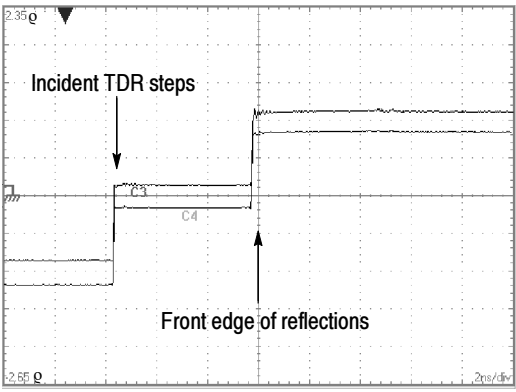
Overview	To take a common mode or differential TDR measurement (cont.)	Control elements & resources
<p>Preset TDR</p>	<ol style="list-style-type: none"> 4. Initialize the instrument (press DEFAULT SETUP). 5. Press the SETUP DIALOGS button and select the TDR tab. 6. Press TDR Preset for both channels (for the sampling module connected to the cables) to turn them on. Select the polarity desired for both channels. <p>TDR Preset sets Internal Clock in the Trigger menu, turns on the TDR Step in the TDR Setups menu, turns on and selects the acquisition Units in the TDR Setups menu.</p> <p>The sampling module will turn on red lights next to the SELECT CHANNEL buttons, indicating that TDR is activated for the channels.</p> <ol style="list-style-type: none"> 7. Set the scale to Ω. 8. Press the SETUP DIALOGS button to dismiss the dialog box. 	
<p>Set Other TDR parameters</p>	<ol style="list-style-type: none"> 9. Adjust the Manual Step Deskew adjustment to set the time at which the step generator for the right channel asserts the TDR step relative to the left channel. Notice that the second edge moves horizontally, relative to the first edge. Adjust the right step generator step to divide the mismatch between channels equally between the incident step and the reflections. 10. After dividing the mismatch equally between channels using Manual Step Deskew, adjust Channel Deskew to align the front edge of the reflections. (for more information see <i>Adjusting TDR Step Deskew</i> on page 37). 11. Press the SETUP DIALOGS button. 12. Adjust the VERTICAL (2.5Ω in this example) and HORIZONTAL SCALE (2 ns in this example) to show a trace similar to that shown. Leave at least one division of baseline trace to the left of the first rise. <p>The first rise of this trace is the incident TDR step leaving the sampling module; the second rise is the reflection of the step returning from the end of the cable.</p>	

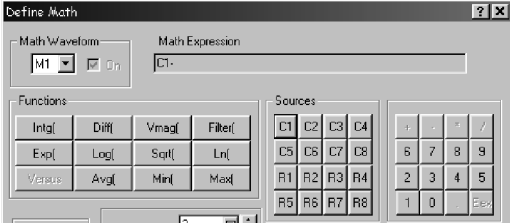
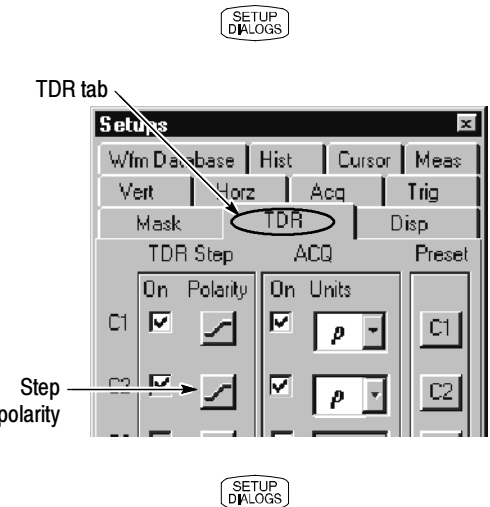
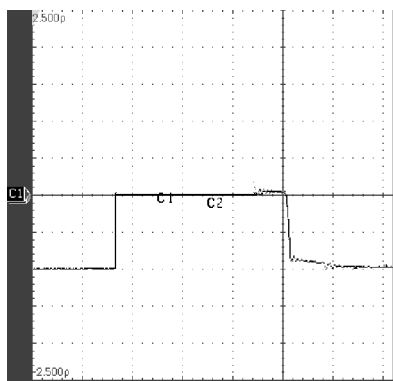
Overview	To take a common mode or differential TDR measurement (cont.)	Control elements & resources
<p>Common mode TDR</p>	<p>13. Notice that both channels assert a positive TDR step for common-mode TDR.</p> <p>14. When the TDR steps on the two channels are the same polarity (both positive or negative), you can define a math waveform that represents the average common-mode signal by pressing the VERTICAL MENU button, selecting the Vert tab, selecting Waveform M1, On, and then selecting Define, C1, +, C2, Math Waveform On, and OK.</p>	
<p>Take a measurement</p>	<p>15. Take your measurement. For more information see <i>Take automatic measurements</i> on page 25, or <i>Take cursor measurements</i> on page 26.</p>	
<p>Enable differential TDR measurements</p>	<p>16. Press the SETUP DIALOGS button, and select the TDR tab.</p> <p>17. Click the TDR STEP Polarity box for one channel to invert the polarity of one of the step generators.</p> <p>Note: Although you have inverted a TDR step, the step is only displayed inverted when the acquisition units are Volts.</p> <p>18. Press the SETUP DIALOGS button.</p>	
<p>Differential TDR</p>	<p>19. One channel is asserting a positive step and the other channel is asserting a negative TDR step. These conditions set up differential TDR.</p>	

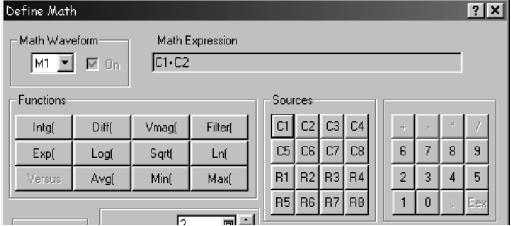
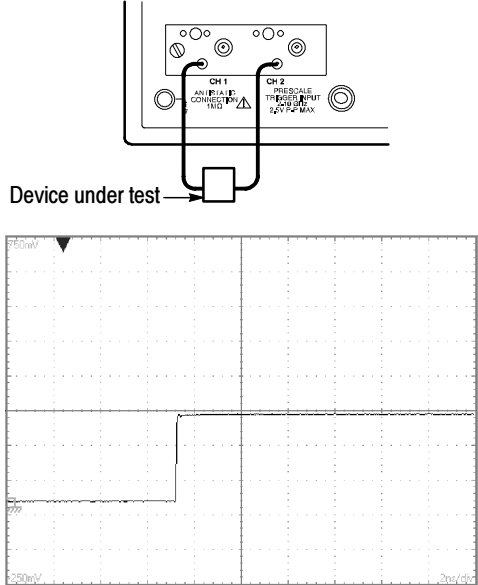
Overview	To take a common mode or differential TDR measurement (cont.)	Control elements & resources
	<p>20. When the TDR steps on the two channels are opposite (one positive and one negative), you can define a math waveform that represents the difference signal by pressing the VERTICAL MENU button, selecting the Vert tab, selecting Waveform M1, On, and then selecting Define, C1, +, C2, Math Waveform On, and OK. Set the scale to ρ. (If using volts, subtract the waveforms.)</p>	
<p>Take a measurement</p>	<p>21. Take your measurement. For more information see <i>Take automatic measurements</i> on page 25, or <i>Take cursor measurements</i> on page 26.</p>	
<p>TDT measurements</p>	<p>22. You can make forward and reverse Time Domain Transmission (TDT) measurements using the 80E04. To perform a TDT measurement: connect one sampling module channel to the input of the device under test and the other sampling module channel to the output of the device under test.</p> <p>23. Then alternately enable the step generators on one channel while sampling the transmitted signal on the other channel to perform forward and reverse TDT measurements. You measure the step transmitted through the device, rather than reflections from the device (as in TDR).</p> <p>Note: If the second channel is not connected to the same device as the first channel, crosstalk is displayed, as opposed to the step transmitted through the device.</p>	
<p>Take a measurement</p>	<p>24. Take your measurement. For more information see <i>Take automatic measurements</i> on page 25, or <i>Take cursor measurements</i> on page 26.</p>	

Adjusting TDR Step Deskew

When making differential or common-mode TDR measurements, the two steps must arrive at the same time at the reference plane (usually the connection point to the device under test). To adjust the TDR step deskew perform the following steps:

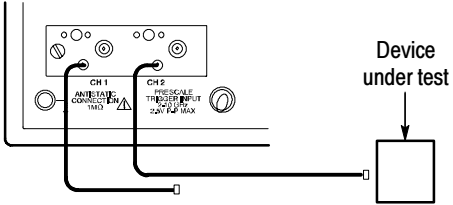
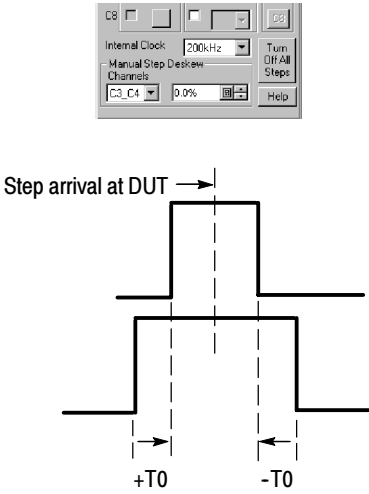
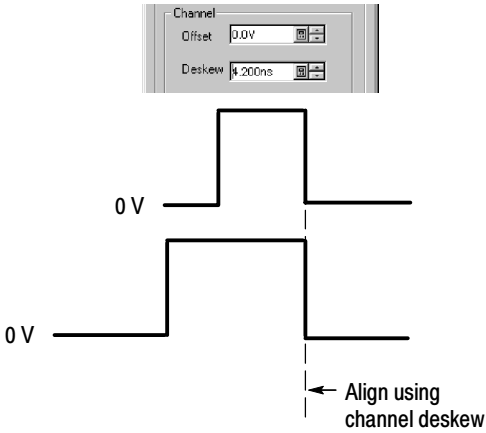
Overview	Adjusting TDR step deskew	Control elements & resources
<p>Prerequisites</p>	<ol style="list-style-type: none"> 1. Either disconnect the transmission cables from the device under test (DUT) at the point where the cables connect to the device, or short both lines to ground at the DUT. Shorted lines are shown in this procedure. 2. Set channel deskew to zero. 	
<p>Adjust TDR step deskew</p>	<ol style="list-style-type: none"> 3. Then, from the TDR setup window, adjust the TDR Manual Step Deskew so that the propagation delay (T_0) between the incident edges is equal to the propagation delay between the reflected edges, as shown in the figure. <p>If using a math function, do not adjust the step more, instead adjust channel deskew as shown in the following step.</p>	
<p>Adjust channel deskew</p>	<p>For some measurements, math summing, and comparisons, you may want to visually line up the reflection edges of both TDR steps, even though you have delayed the step assertion time for one channel in the preceding step.</p> <ol style="list-style-type: none"> 4. To do this, first deskew the steps as shown above, then, from the Vertical setup window, deskew the channels. 	

- Reduce connector wear by keeping connectors clean and by connecting them properly.
- Replace calibration devices with worn connectors, and use an adapter on the input connector, when applicable, to minimize wear.
- Inspect connector mating-plane surfaces for dents, scratches, and for dirt and particles. Check for damage due to uneven or excessive misalignment or wear.
- Carefully inspect the contact fingers in the female center conductor when using slotted connectors. Damage, which is not always easy to see, can result in poor electrical contact. When mating precision to nonprecision devices, this is especially important.

Cleaning Connectors

Clean connectors are essential for ensuring the integrity of RF and coaxial connections. This section covers precautions, cleaning connector threads, cleaning the mating plane surfaces, and inspecting the connector.

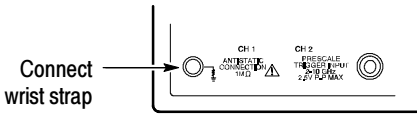
Overview	To follow proper cleaning procedures	Control elements & resources
<p>Cleaning Precautions</p>	<ol style="list-style-type: none"> 1. Ground the hose nozzle to prevent ESD. See <i>Electrostatic Discharge</i> on page 38. 2. Air or nitrogen source should have an effective oil-vapor filter and liquid condensation trap just before the outlet hose. 3. Always use protective eyewear when using compressed air or nitrogen. 4. Set the pressure to less than 414 kPa (60 psi) to control the velocity of the air stream. Compressed air can cause ESD when directed into a connector. 5. Keep isopropyl alcohol away from heat, sparks, and flame. Store properly, and in case of fire, use alcohol foam, dry chemical, or carbon dioxide, since water may not work. 6. Use isopropyl alcohol with adequate ventilation and avoid contact with eyes, skin, and clothing. Wash thoroughly after handling. 7. In case of a spill, soak up with sand or earth, and flush spill area. 8. Dispose of isopropyl alcohol in accordance with the applicable federal, state, and local regulations. 	 <p>Connect wrist strap</p>

Overview	To follow proper cleaning procedures (cont.)	Control elements & resources
<p>Cleaning the connector threads</p>	<ol style="list-style-type: none"> 1. Use compressed air or nitrogen to loosen particles on the connector mating plane surfaces. See the preceding <i>Precautions</i>. 2. To remove dirt or stubborn contaminants on a connector that cannot be cleaned with compressed air or nitrogen, apply a small amount of isopropyl alcohol to a lint-free cleaning swap. A standard foam-tipped swap is recommended. 3. Clean the connector threads. 4. After the alcohol evaporates, blow the threads dry using low-pressure compressed air or nitrogen. Make sure the threads are completely dry before you reassemble it. 	
<p>Cleaning the mating plane surfaces</p>	<ol style="list-style-type: none"> 1. Using a small amount of isopropyl alcohol on a lint-free cleaning swap, clean the mating surfaces of the center and outer conductors. 2. After the alcohol evaporates, blow the mating surfaces dry using low-pressure compressed air or nitrogen. Make sure the connector is completely dry before you reassemble it. 	
<p>Inspecting the connector</p>	<ol style="list-style-type: none"> 1. Inspect the connector to make sure it is residue free. 2. Refer to <i>Visual Inspection</i> on page 38 for more information. 	

Assembly and Torquing

Good connections require a skilled operator. The most common cause of measurement error is bad connections. The procedures in this section describe how to make good connections.

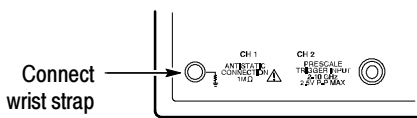
Overview	To properly perform assembly and torquing of connectors	Control elements & resources
<p>Prerequisites and precautions</p>	<ol style="list-style-type: none"> 1. Ground yourself and all devices. Wear a grounded wrist strap and work on a grounded, conductive table mat. Also see <i>Electrostatic Discharge</i> on page 38. Refer to the illustration at right. 2. Inspect connectors. See <i>Visual Inspection</i> on page 38. 3. If necessary, clean the connectors. See <i>Cleaning Connectors</i> on page 39. 4. Use a connector gage to verify that all center conductors are within the observed pin depth values. 5. For multiple connections, always put the fixed wrench on the inside (stationary) half of a connection, and apply torque to the outside movable half. 6. Always torque a single connection, never multiple connections. 	
<p>Torquing an inline connector to a stationary connector</p>	<ol style="list-style-type: none"> 1. Carefully align connectors. Male connector pin must slip concentrically into the contact finger of the female connector. 2. Push the connectors straight together and tighten the connector nut finger tight. Do not turn the device body. There is usually a slight resistance as the center conductors mate. Uniform, light contact is sufficient for the preliminary connection; do not overtighten. 3. Ensure that the connectors are properly supported. As needed, relieve any side pressure on the connection from long or heavy devices or cables. 	

Overview	To properly perform assembly and torquing of connectors (cont.)	Control elements & resources
<p>Torquing multiple inline connectors</p>	<ol style="list-style-type: none"> 1. If starting from a fully disassembled state, order the connections so that they are assembled from the outside moveable portions toward the inward (stationary) portions. Disassemble from the inside outward. 2. If starting from a partially disassembled state, such as with a protective coupler, leave subassemblies intact. 3. Maximize protection and minimize disturbance for the connection that is intended to be preserved by the protective coupler. 	
<p>Joining two stationary connectors with a semi-rigid coaxial cable</p>	<ol style="list-style-type: none"> 1. Position the cable and order the connections to minimize the side and end loading on the last connection. 2. If available, use a protective connector to prevent or reduce damage to a connector. 	
<p>Final connection</p>	<ol style="list-style-type: none"> 1. Use a torque wrench to make the final connection. See Table 5 on page 42 for torque wrench information. 2. Rotate only the connector nut that you are tightening. If necessary, use an open-end wrench to keep the body of the device from turning. 3. Position both wrenches within 90 degrees of each other before applying force. Refer to the illustration at right. 4. Hold the torque wrench lightly at the end of the handle. 5. Apply downward force perpendicular to wrench handle; this applies torque to connection through the wrench. 6. Tighten the connection just to the point that the wrench breaks over. Do not overtighten the connection. 	

Table 5: Torque Wrench Information

Connector Type	Torque Setting	Torque Tolerance
SMA	56 N-cm (5 in-lb)	± 5.6 N-cm (± 0.5 in-lb)
2.4 mm	90 N-cm (8 in-lb)	± 9.0 N-cm (± 0.8 in-lb)
2.92 mm	90 N-cm (8 in-lb)	± 9.0 N-cm (± 0.8 in-lb)
3.5 mm	90 N-cm (8 in-lb)	± 9.0 N-cm (± 0.8 in-lb)

TDR Impedance Measuring

This stand-alone application implements the TDR calibration procedure(s) specified by the IPC-TM-650 test methodology. It enhances the accuracy and repeatability of impedance measurements by calibrating the test setup to correct for losses and impedance discontinuities. Additionally, this application can use a database for storing TDR measurements. This application is not installed on your instrument, but it can be installed from the 8000 Series Demo Application CD shipped with the instrument.

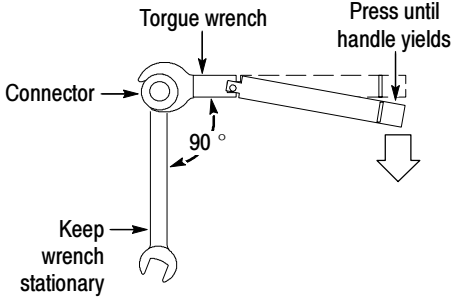
For more information see *TDR Impedance-Measuring Application Online Help*.

Detecting Blown Inputs

Checking For Damage

Because of their technology, high-bandwidth sampling modules are vulnerable to damage through static discharge and overvoltages (EOS) to the input.

Damage can occur instantaneously. Under most conditions when EOS damage occurs, the trace will be flat. It typically involves short-period, high-current discharge. The damages can be blown diodes as indicated by large offset or no response to input.

To check for damage, use one of the following procedures:

- If checking an 80E04 sampling module and your instrument has TDR capability, attach a 50 Ω termination to the channel input and perform a TDR measurement of the attached fitting. Adjust the HORIZONTAL SCALE to 500 ns per division. This should display the entire TDR step from edge to edge. Display the step top at 40 mV per division and check for flatness. If the top is bowed, sagged, hooked, or tilted, assume static has damaged the module and service is required. See Figure 16 on page 44.
- If checking a non-TDR sampling module, use a procedure similar to the preceding procedure, but use an external step source. The Tektronix part number 067-1338-00 is recommended.

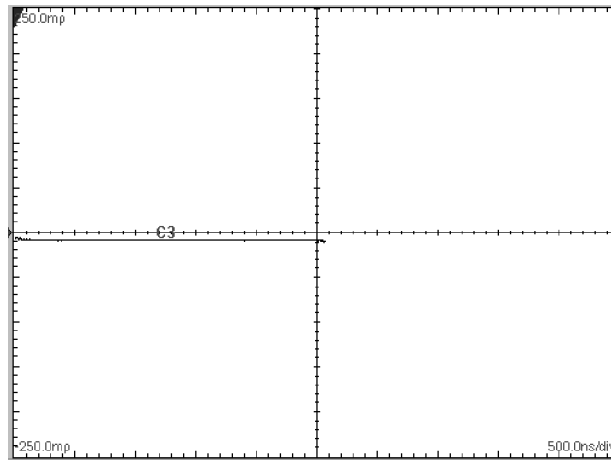

Figure 16: TDR step of undamaged sampling module

EOS (Electrical Overstress) Prevention

EOS occurs when an electronic device is subjected to an input voltage higher than its designed maximum tolerable level. Similar to ESD (Electrical Static Damage), EOS usually is also related to static charges generated by moving elements. However, unlike ESD that typically deals with thousands of volts, EOS can occur at a low voltage level. For Tektronix 80E00-series modules, EOS damage could occur at levels as low as 10 V. EOS can have a cumulative effect; repetitive EOS causes incremental damage over time and results in sampling function deterioration.

Prevention

Standard ESD precautions are not very effective for EOS damage prevention. This is particularly true when the DUT (Device Under Test) is isolated from any reference voltage levels, including the ground level. To prevent EOS damage of 80E00-series modules, strictly follow these EOS-prevention requirements:

- Observe all ESD prevention procedures.
- Before letting the probe tip touch the device under test, use a ground-conducting element to discharge any residual charge at the test point.
- While measuring the DUT, make sure that no nearby personnel or objects are moving. Moving personnel or objects can induce spurious charges on the probe head. Such charges can easily reach levels of several hundred volts.
- For non-critical applications, proper usage of a static-isolation unit, such as the Tektronix SIU800, can safely discharge the residual charges and protect the modules from EOS damages.

Checking For Damage

If the waveform top is bowed, sagged, hooked, or tilted, assume static has damaged the module and service is required. Figure 17 on page 45 shows a typical waveform signature indicating EOS damage.

Also be aware that EOS can be cumulative; that is, every time an EOS event occurs during testing, EOS damage can accumulate until there is even greater damage as shown in Figure 18 on page 46. In this example, the percentage of overshoot is increased.

To check for damage, use one of the following procedures:

If checking an 80E04 sampling module and your instrument has TDR capability, attach a $50\ \Omega$ termination to the channel input and perform a TDR measurement of the attached fitting:

1. Select the TDR channel to turn it on.
2. Press the TDR preset.
3. Adjust the HORIZONTAL SCALE to $2\ \mu\text{s}$ per division. The vertical setting should be $200\ \text{m}\Omega$ as shown in the illustrations. This should display the entire TDR step from edge to edge. Display the step top at $40\ \text{m}\Omega$ per division and check for flatness. The top of the waveform should be flat.

If checking a non-TDR sampling module, use a procedure similar to the preceding procedure, but use an external step source. The Tektronix part number 067-1338-00 is recommended.

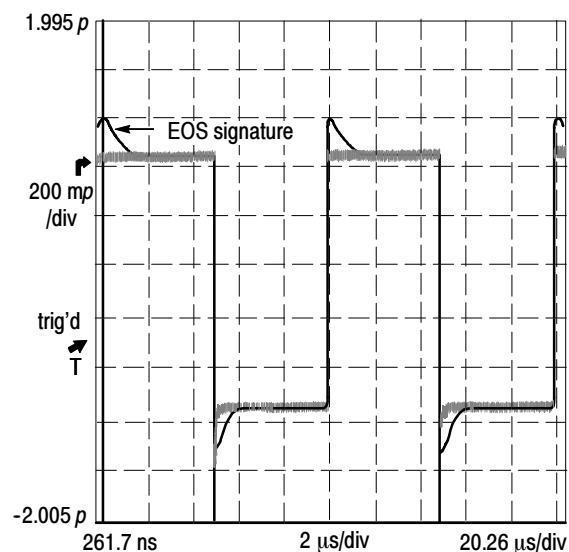

Figure 17: First example of EOS error

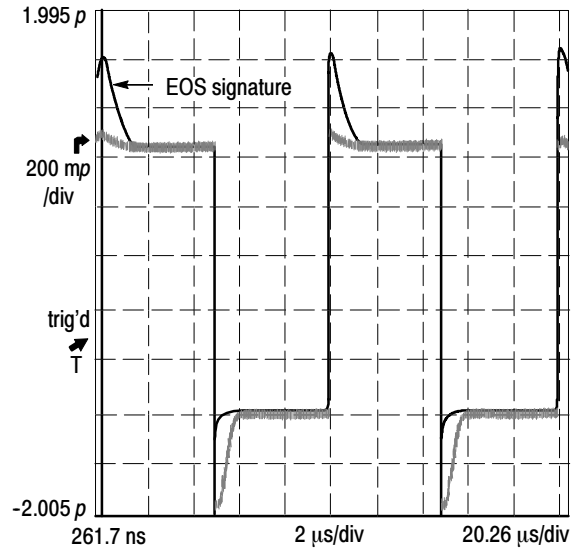

Figure 18: Second example of EOS error showing cumulative effect

Specifications

This section contains specifications for the 80E01, 80E02, 80E03, 80E04, and 80E06 sampling modules. All specifications are guaranteed unless noted as “typical.” Typical specifications are provided for your convenience but are not guaranteed. Specifications that are marked with the ✓ symbol are checked in *Performance Verification* in the service manual.

All specifications apply to all models of sampling module unless noted otherwise. To meet specifications, three conditions must first be met:

- The instrument must have been calibrated/adjusted at an ambient temperature between +20 °C and +30 °C.
- The oscilloscope must have been operating continuously for 20 minutes within the operating temperature range specified.
- The instrument must be in an environment with temperature, altitude, humidity, and vibration within the operating limits described in these specifications

NOTE. “*Sampling Interface*” refers to both the electrical sampling module interface and the optical module interface, unless otherwise specified.

Table 6: Electrical sampling modules - Descriptions

Sampling module	Description
80E01	1 channel 50 GHz (7 ps risetime) bandwidth, 50 Ω sampling module.
80E02	2 channel 12.5 GHz (28 ps risetime) bandwidth, 50 Ω, low noise sampling module.
80E03	2 channel 20 GHz (17.5 ps risetime) bandwidth, 50 Ω sampling module.
80E04	2 channel 20 GHz (17.5 ps risetime) bandwidth, 50 Ω TDR/sampling module with 35 ps single ended, common mode, and differential TDR capability.
80E06	1 channel 70 GHz (5.0 ps risetime) bandwidth, 50 Ω sampling module.

Table 7: Electrical sampling modules - Signal acquisition

Specifications	Characteristics	
Real time accessory interface	Tekprobe-SMA interface is provided through the electrical sampling-module interface, one per vertical channel.	
Channel input connector	<i>Sampling module</i>	<i>Input connector</i>
	80E02, 80E03, 80E04	Precision 3.5 mm female connector.
	80E01	Precision 2.4 mm female connector (2.4 mm male to 2.92 mm (K) female adapter, 015-0703-xx, is supplied).
	80E06	Precision 1.85 mm female connector (V) (2.4 mm male to 2.92 mm (K) female adapter, 015-0703-xx, is supplied).
Number of input channels	<i>Sampling module</i>	<i>Channels</i>
	80E01, 80E06	1
	80E02, 80E03, 80E04:	2
✓ Input impedance	50 Ω \pm 0.5 Ω	
Vertical dynamic range	1 V _{pp} (offset \pm 500 mV)	
Vertical operating range ¹ , maximum	\pm 1.6 V	
Vertical nondestruct range ² (Maximum input voltage)	<i>Sampling module</i>	<i>Maximum input</i>
	80E01, 80E06	2.0 V (DC+peak AC)
	80E02, 80E03, 80E04	3.0 V (DC+peak AC)
Vertical number of digitized bits	14 bits full scale	
Vertical sensitivity range ³	The range of available full scale input settings. 10 mV to 1 V full scale	
Compensation temperature range	\pm 5° C about temperature where compensation was performed. If compartment is changed on the mainframe, a sampling module extender is employed, or the length of the sampling module extender is changed, the channel must be recompensated.	
✓ DC voltage accuracy, single point, within \pm 5° C of compensated temperature	\pm 2 mV \pm 0.007 (assigned offset) \pm 0.02 (vertical value - assigned offset)	
✓ DC vertical voltage deviation from linear least squares fit	\pm 10 mV	

Table 7: Electrical sampling modules - Signal acquisition (cont.)

Specifications	Characteristics	
✓ Rise time ⁴	<i>Sampling module</i>	<i>Rise time</i>
	80E01	≤ 7 ps, typical
	80E02	≤ 28 ps
	80E03 and 80E04	≤ 17.5 ps
	80E06	≤ 5.0 ps, typical
✓ Analog bandwidth ⁵	<i>Sampling module</i>	<i>Bandwidth</i>
	80E01	50 GHz
	80E02	12.5 GHz, typical
	80E03 and 80E04	20 GHz, typical
	80E06	65 GHz 70 GHz, typical
Step response aberrations ⁷ , typical	<i>Sampling module</i>	<i>Aberrations, step transition⁶</i>
	80E02, 80E03 and 80E04	± 3% or less over the zone 10 ns to 20 ps before step transition +10%, -5% or less for the first 300 ps following step transition ± 3% or less over the zone 300 ps to 5 ns following step transition ± 1% or less over the zone 5 ns to 100 ns following step transition ± 0.5% after 100 ns following step transition
	80E01	± 3% or less over the zone 10 ns to 20 ps before step transition +12%, -5% or less for the first 300 ps following step transition +5.5%, -3% or less over the zone 300 ps to 3 ns following step transition ± 1% or less over the zone 3 ns to 100 ns following step transition ± 0.5% after 100 ns following step transition
Step response overshoot ⁷ , typical	80E06	+ 5% or less for the first 300 ps following step transition

Table 7: Electrical sampling modules - Signal acquisition (cont.)

Specifications	Characteristics	
✓ Random noise, displayed	<i>Sampling module</i>	<i>Noise</i>
	80E01	≤ 2.3 mV _{RMS} 1.8 mV _{RMS} , typical
	80E02	≤ 800 mV _{RMS} 400 μV _{RMS} , typical
✓ Random noise, displayed	80E03 and 80E04	≤ 1.2 mV _{RMS} 600 μV _{RMS} , typical
✓ Random noise, displayed	80E06	≤ 2.4 mV _{RMS} ≤ 1.8 mV _{RMS} , typical
Offset range ¹	± 1.6 V	

- ¹ **Vertical operating range defines the maximum range over which the offset plus peak input signal can operate. The offset may be limited as a function of vertical sensitivity and dynamic range, such that no signal exceeding the maximum operating range can be displayed.**
- ² **Vertical nondestruct range defines the maximum range over which offset plus peak input signal can operate without irreversible damage to the instrument. Operation to instrument specification is not guaranteed outside of the vertical operating range.**
- ³ ***Input Signal Ranges* in IEEE std 1057, section 2.2.1.**
- ⁴ **IEEE std 1057, section 4.8.2, *Transition Duration of Step Response*. The 80E01 rise time is calculated from the 0.35 bandwidth-risetime product. The 80E06 rise time is calculated from the 0.35 typical bandwidth-risetime product.**
- ⁵ **IEEE std 1057, section 4.6, *Analog Bandwidth*.**
- ⁶ **IEEE std 1057, section 4.8.4, *Overshoot and Precursors*. Step transition occurs at the point of minimum radius of the waveform curvature, after the 50% amplitude point of the step leading edge.**
- ⁷ **When tested using a V-connector equipped 50-ohm, ultrafast PIN Photodetector with greater than 50 GHz bandwidth, which is driven by an ultrafast, mode-locked impulse laser (for example, the Calmar FPL-01).**
- ⁸ **Because the 2.4 mm connector of this adapter will mechanically interface with the 1.85 mm connector of the 80E06, it serves as a 1.85 mm-to-2.92 mm connector for the 80E06 module.**

Table 8: Electrical sampling module (80E04) - TDR system

Specifications	Characteristics
Number of TDR channels	2, one per channel
TDR polarity and operation mode selections	Positive polarity, negative polarity, and TDR off are independently selectable for each channel.

Table 8: Electrical sampling module (80E04) - TDR system (cont.)

Specifications	Characteristics
Maximum input voltage	Do not apply input voltage during TDR operation.
TDR amplitude	250 mV each polarity, typical
✓ TDR system reflected rise time ¹	≤ 35 ps each polarity
TDR system incident rise time	28 ps, typical
TDR step maximum repetition rate	200 kHz
✓ TDR system step response aberrations ²	±3% or less over the zone 10 ns to 20 ps before step transition +10%, -5% or less typical for the first 400 ps following step transition ±3% or less over the zone 400 ps to 5 ns following step transition ±1% or less after 5 ns following step transition

¹ IEEE std 1057, section 4.8.2, transition duration of step response.

² IEEE std 1057, section 4.8.4, overshoot and precursors.

Table 9: Electrical sampling modules - Timebase system

Specifications	Characteristics
Sampling rate	DC-200 kHz maximum.
Horizontal position range, minimum (deskew adjust range between channels)	≤ 19 ns, no extender cable present, external direct trigger operation.

Table 10: Electrical sampling modules - Power consumption

Specifications	Characteristics	
Power dissipation	<i>Sampling module</i>	<i>Power dissipation</i>
	80E01	1.1 W
	80E02, 80E03	1.8 W
	80E04	3.2 W
	80E06	2.4 W

Table 11: Electrical sampling modules - Mechanical

Specifications	Characteristics
Weight (unpackaged)	0.4 kg (13 oz.)
Overall dimensions	Height: 25 mm (1.0 in) Width: 79 mm (3.1 in) Depth: 135 mm (5.3 in) Does not include connectors, connector savers, connector covers, push buttons, or lock-down hardware protruding from the front or rear panels.
Construction material	Chassis: aluminum alloy Front panel: plastic laminate Circuit boards: glass-laminate Cabinet: aluminum

NOTE. For System - Environmental specifications, refer to the CSA8000B and TDS8000B User Manual.

Glossary

Accuracy

The closeness of the indicated value to the true value.

Analog-to-Digital Converter

A device that converts an analog signal to a digital signal.

Attenuation

A decrease in magnitude of current, voltage, or power of a signal.

Attenuator

An electronic transducer that reduces the amplitude of a signal.

Autoset

A means of letting the instrument set itself to provide a stable and meaningful display of a given trace.

Bandwidth

The range of frequencies handled by a device or system. Bandwidth is a measure of network capacity. Analog bandwidth is measured in cycles per second. Digital bandwidth is measured in bits of information per second.

Channel

A place to connect a signal or attach a network or transmission line to sampling modules.

Common Mode

A circumstance where a signal is induced in phase on both sides of a differential network.

dB

Decibel: a method of expressing power or voltage ratios. The decibel scale is logarithmic. The formula for decibels is:

$$\text{dB} = 20 \log (V_i/V_{\text{ref}})$$

where V_i is the voltage of the incident pulse, V_{ref} is the voltage reference, and \log is the decimal-based logarithmic function.

Dialog Box

A displayed box in which you enter instrument commands.

Differential Mode

A circumstance where the true signal and its logical complement are transmitted over a pair of conductors.

Digital Signal

A signal made up of a series of on and off pulses.

Electrical Overstress (EOS)

Electrical overstress occurs when an electronic device is subjected to an input voltage higher than the designed maximum tolerable level.

External Attenuation

Attenuation that is outside the sampling module.

Impedance

The opposition to an AC signal in the wire. Impedance is very much like resistance to a DC signal in a DC circuit. Impedance is made up of resistance and inductive and capacitive reactance.

Incident Step

The electrical energy transmitted by the TDR step generator. An acquired waveform shows this step and all reflections on the signal conductor.

Initialize

Setting the main instrument to a completely known, default condition.

Internal Clock

A trigger source generated internally within the instrument and used to synchronize TDR step generators. Also available at the front panel Internal Clock Output connector.

Rho (ρ)

When making TDR measurements, the ratio of the incident step to the reflected step. A value of one (1) indicates complete reflection.

Setting

The state of the front panel and system at a given time.

TDR

Time-Domain Reflectometer: an instrument that sends out steps of energy and measures the amplitude and time interval of the reflections. If the velocity of the energy through the cable is known, distances to features can be computed and displayed. Conversely, the speed that energy travels through a cable of known length can also be computed. The way in which the energy is reflected and the amount of the energy reflected indicate the condition of the cable.

Time Domain Transmission (TDT)

A method of characterizing a transmission line or network by transmitting a signal through the network and monitoring the output.

Trigger

An electrical event that initiates acquisition of a sample as specified by the time base.

Waveform

The visible representation of an input signal or combination of signals.

Index

A

- Accessories, 4
 - List, 4
 - Optional, 4
 - Standard, 4
- Accuracy, 53
- Address, Tektronix, vi
- Adjustments, 14
- Analog-to-digital converter, 53
- Application software version, requirement vs. module model, 1
- Assembly and Torquing
 - procedure, 41
 - tips, 41
- Attenuation, 53
- Attenuator, 53
- Automatic measurements, 25
- Autoset, 53

B

- Bandwidth, 53
- Baseline correction, 20
- Blown inputs, detecting, 43

C

- Channel, 53
- Channel selection, 12
- Checking for damage, 43
- Circuitry, 3
- Cleaning, exterior, 14
- Cleaning Connectors
 - precautions, 39
 - procedures, 40
- Commands
 - Main instrument front panel, 13
 - Programmer interface, 14
- Common mode, 53
 - TDR, 33
- Common mode TDR measurements, 18, 33, 35
- Compensation, 5, 8
 - when installing/moving sampling modules, 8
- Connector and Adapter Care, 38
- Connectors, 12
- Contacting Tektronix, vi
- Cursor measurements, 26

D

- dB, 53
- Decibel, 53
- Detecting blown inputs, 43
- Dialog box, 53
- Differential mode, 53
- Differential TDR measurements, 18, 33
- Digital signal, 53

E

- Electrical Overstress Prevention, Causes, 44
- Electrostatic discharge, 6
 - procedures, 38
 - protection against, 38
- EOS, 54
 - Checking for damage, 45
 - Example of EOS, 45
 - Prevention, 44
 - Second example of EOS, 46
- EOS Prevention, 44
- Extender cable, 5
- External attenuation, 54

F

- Front panel controls, 12

G

- Getting started, 1
- Glossary, 53

H

- Horizontal units, selecting, 24

I

- Impedance, 54
- Incident step, 54
- Initialize, 54
- Input voltage, maximum, 11
- Installation, 6
- Internal clock, 54

M

Manuals, part numbers, 4
Measurements
 Automatic, 25
 Cursor, 26
Measurements, TDR, 17, 32

O

Operating basics, 11
Optional accessories list, 4
Options, List, 4

P

Phone number, Tektronix, vi
Product description, 2
Product support, contact information, vi
Programmer commands, 14
Propagation delay adjustment, TDR, 37

R

Reference, 17
Reference plane, 37
Rho units, selecting, 23

S

Safety Summary, iii
SELECT CHANNEL button, 12, 13
Service support, contact information, vi
Setting, 54
Signal Connector, 12
Software application version, requirement vs. module model, 1
Specifications, 47
Standard accessories, 4
Static controlled workstation, 7
Step Deskew, TDR, 37
Step generation, TDR, 18
Step generator, operation, 18, 19, 20
System interaction, 13

T

TDR, 54
 adjust channel deskew, 37

 Calibration application, 43
 Cause of reflections, 28
 Changing graticule units, 23
 Common mode, 32, 35
 Common mode measurements, 33
 database interface, 43
 differential and common mode measurements, 36
 Differential measurements, 33
 Differential mode, 32
 enable differential measurements, 35
 Example measurements, 22, 33
 Finding velocity of propagation, 30
 Locating mismatches, 30
 Measurement range, 29
 Measurement units, 30
 Measurements, 17, 32
 Measurements background, 27
 On indicator, 13
 Propagation delay adjustment, 37
 Step deskew, 37
 Step generation, 18
 Taking accurate measurements, 32
 Taking horizontal measurements, 24
 taking measurements, 33, 34, 36, 37
 To take a measurement, 22
 undamaged sampling module, 44
TDR measurements, 17
Technical support, contact information, vi
TEKPROBE connector, 13
Tektronix, contacting, vi
Time-domain reflectometer, 54
Torque wrench information, 42
Trigger, 54

U

URL, Tektronix, vi
Usage, 11

V

Visual Inspection, 38

W

Waveform, 54
Web site address, Tektronix, vi