



ABN 43 064 478 842

231 Osborne Avenue Clayton South, VIC 3169
PO Box 1548, Clayton South, VIC 3169
t 03 9265 7400 f 03 9558 0875
freecall 1800 680 680
www.tmgtestequipment.com.au

Test & Measurement

- > sales
- > rentals
- > calibration
- > repair
- > disposal

Complimentary Reference Material

This PDF has been made available as a complimentary service for you to assist in evaluating this model for your testing requirements.

TMG offers a wide range of test equipment solutions, from renting short to long term, buying refurbished and purchasing new. Financing options, such as Financial Rental, and Leasing are also available on application.

TMG will assist if you are unsure whether this model will suit your requirements.

Call TMG if you need to organise repair and/or calibrate your unit.

If you click on the "Click-to-Call" logo below, you can call us for FREE!

TMG Corporate Website

TMG Products Website



Click-to-Call
TMG Now



Product Lifecycle Management System

Disclaimer:

All trademarks appearing within this PDF are trademarks of their respective owners.



User Manual 1



DTG5078 & DTG5274 &DTG5334 Data Timing Generators

071-1608-00

This document supports firmware version 2.0.0 and above.

www.tektronix.com

Copyright © Tektronix, Inc. All rights reserved.

Tektronix products are covered by U.S. and foreign patents, issued and pending. Information in this publication supercedes that in all previously published material. Specifications and price change privileges reserved.

Tektronix, Inc., P.O. Box 500, Beaverton, OR 97077-0001

TEKTRONIX and TEK are registered trademarks of Tektronix, Inc.

WARRANTY

Tektronix warrants that this product will be free from defects in materials and workmanship for a period of one (1) year from the date of shipment. If any such product proves defective during this warranty period, Tektronix, at its option, either will repair the defective product without charge for parts and labor, or will provide a replacement in exchange for the defective product. Parts, modules and replacement products used by Tektronix for warranty work may be new or reconditioned to like new performance. All replaced parts, modules and products become the property of Tektronix.

In order to obtain service under this warranty, Customer must notify Tektronix of the defect before the expiration of the warranty period and make suitable arrangements for the performance of service. Customer shall be responsible for packaging and shipping the defective product to the service center designated by Tektronix, with shipping charges prepaid. Tektronix shall pay for the return of the product to Customer if the shipment is to a location within the country in which the Tektronix service center is located. Customer shall be responsible for paying all shipping charges, duties, taxes, and any other charges for products returned to any other locations.

This warranty shall not apply to any defect, failure or damage caused by improper use or improper or inadequate maintenance and care. Tektronix shall not be obligated to furnish service under this warranty a) to repair damage resulting from attempts by personnel other than Tektronix representatives to install, repair or service the product; b) to repair damage resulting from improper use or connection to incompatible equipment; c) to repair any damage or malfunction caused by the use of non-Tektronix supplies; or d) to service a product that has been modified or integrated with other products when the effect of such modification or integration increases the time or difficulty of servicing the product.

THIS WARRANTY IS GIVEN BY TEKTRONIX WITH RESPECT TO THE PRODUCT IN LIEU OF ANY OTHER WARRANTIES, EXPRESS OR IMPLIED. TEKTRONIX AND ITS VENDORS DISCLAIM ANY IMPLIED WARRANTIES OF MERCHANTABILITY OR FITNESS FOR A PARTICULAR PURPOSE. TEKTRONIX' RESPONSIBILITY TO REPAIR OR REPLACE DEFECTIVE PRODUCTS IS THE SOLE AND EXCLUSIVE REMEDY PROVIDED TO THE CUSTOMER FOR BREACH OF THIS WARRANTY. TEKTRONIX AND ITS VENDORS WILL NOT BE LIABLE FOR ANY INDIRECT, SPECIAL, INCIDENTAL, OR CONSEQUENTIAL DAMAGES IRRESPECTIVE OF WHETHER TEKTRONIX OR THE VENDOR HAS ADVANCE NOTICE OF THE POSSIBILITY OF SUCH DAMAGES.

Table of Contents

General Safety Summary	vii
Preface	ix
About This Manual	ix
Related Manuals and Online Documents	x
Contacting Tektronix	xi

Getting Started

Product Description	1-1
Models	1-1
Key Features	1-1
Mainframe and Output Module Configuration	1-4
Product Software	1-5
Software Upgrade	1-6
Installation	1-7
Unpacking	1-7
Checking the Environmental Requirements	1-8
Output Module	1-9
Connecting to a Network	1-10
Connecting Peripherals	1-11
Powering On the Data Timing Generator	1-12
Setting up Windows 2000	1-13
Powering Off the Data Timing Generator	1-14
Creating an Emergency Rescue Disk	1-16
Backing Up User Files	1-18
Installing Software	1-18
Accessories & Options	1-19
Options	1-19
Accessories	1-21

Operating Basics

Operating Basics	2-1
Front Panel	2-1
Front Panel Controls	2-3
Front Panel Connectors	2-5
Rear Panel Connectors	2-9
Display Area and Application Windows	2-14
Using the Menu System	2-41

Data Structure

Data Structure	3-1
Internal Pattern Data	3-1
Grouping and Channel Assignment	3-5

Tutorials

Tutorials	4-1
Tutorial 1: Pulse Generator Mode	4-4
Tutorial 2: Data Generator Mode	4-14
Tutorial 3: Creating a Sequence	4-31

Index

Index	Index-1
--------------------	----------------

List of Figures

Figure 1-1: Locations of peripheral connectors on rear panel	1-11
Figure 1-2: Principal power switch and AC power connector	1-12
Figure 1-3: On/Standby switch location	1-12
Figure 2-1: Front panel (DTG5078)	2-1
Figure 2-2: Front panel (DTG5274, DTG5334)	2-2
Figure 2-3: Front panel controls	2-3
Figure 2-4: Front panel connectors	2-6
Figure 2-5: Rear panel (DTG5078)	2-9
Figure 2-6: Rear panel connector (1)	2-10
Figure 2-7: Rear panel connectors (DTG5078) (2)	2-11
Figure 2-8: Screen elements just after the power on	2-14
Figure 2-9: Toolbar	2-19
Figure 2-10: Status bar	2-20
Figure 2-11: Channel Group window	2-21
Figure 2-12: Blocks window	2-22
Figure 2-13: Data-Listing window	2-24
Figure 2-14: Data-Waveform window	2-26
Figure 2-15: Level window	2-28
Figure 2-16: Timing window (Data Generator mode)	2-30
Figure 2-17: Time Base window	2-32
Figure 2-18: Sequence window	2-34
Figure 2-19: Subsequence window	2-36
Figure 2-20: Jitter Generation window	2-38
Figure 2-21: DC Output window	2-39
Figure 2-22: Menu selection	2-41
Figure 2-23: Window operation 1: Time Base window	2-42
Figure 2-24: Window operation 2: Timing window	2-44
Figure 2-25: Window operation 3: Data-Listing window	2-46
Figure 2-26: Window operation 4: Channel Group window	2-48
Figure 2-27: Window operation 5: Sequence window	2-49
Figure 3-1: Channels, groups, blocks and channel assignment	3-1
Figure 3-2: Concept of data and window	3-4
Figure 3-3: Channel assignment	3-5
Figure 3-4: Channel Group window	3-6
Figure 4-1: Confirming Offline mode	4-1
Figure 4-2: Select the online mode	4-2
Figure 4-3: Time Base window (Pulse Generator mode)	4-4
Figure 4-4: Level window (Pulse Generator mode)	4-5
Figure 4-5: Timing window (Pulse Generator mode)	4-9
Figure 4-6: Blocks window	4-14
Figure 4-7: Channel Group window	4-15
Figure 4-8: Data-Listing window	4-19
Figure 4-9: Edit menu and View menu	4-19
Figure 4-10: View by Channel and View by Group	4-21

Figure 4-11: Timing window	4-28
Figure 4-12: SubBinary and SubWalking subsequences	4-33
Figure 4-13: Main sequence	4-36
Figure 4-14: Flowchart	4-37

List of Tables

Table 1-1: DTG5000 series key features	1-2
Table 1-2: DTG5000 series Output module key features	1-3
Table 1-3: Current consumption coefficient	1-4
Table 1-4: Operating requirements	1-9
Table 1-5: Additional connection information	1-11
Table 1-6: Instrument options	1-19
Table 1-7: Power cord options	1-19
Table 1-8: Language options	1-20
Table 1-9: Standard accessories	1-21
Table 1-10: Optional accessories	1-22
Table 2-1: Front panel controls	2-3
Table 2-2: Front panel connectors	2-6
Table 2-3: Rear panel connectors (1)	2-10
Table 2-4: Rear panel connectors (2)	2-11
Table 2-5: Control box menus	2-14
Table 2-6: File menus	2-15
Table 2-7: View menus	2-15
Table 2-8: Settings menus	2-16
Table 2-9: System menus	2-17
Table 2-10: Options menu	2-17
Table 2-11: Help menus	2-18
Table 2-12: Status Bar	2-20
Table 2-13: Edit menus for Channel Group window	2-21
Table 2-14: Setup items for Blocks window	2-23
Table 2-15: Edit menus for Blocks window	2-23
Table 2-16: Edit menus for Data-Listing window	2-25
Table 2-17: Edit menus for Data-Waveform window	2-26
Table 2-18: Setup items for Level window	2-28
Table 2-19: Edit menus for Level window	2-29
Table 2-20: Setup items for Timing window	2-30
Table 2-21: Edit menus for Timing window	2-31
Table 2-22: Setup items for Time Base window	2-32
Table 2-23: Setup items for Sequence window	2-34
Table 2-24: Edit menus for Sequence window	2-35
Table 2-25: Setup items for Subsequence window	2-36
Table 2-26: Edit menus for Subsequence window	2-37
Table 2-27: Setup items for Jitter Generation window	2-38
Table 2-28: Setup items for DC Output window	2-39
Table 2-29: Edit menus for DC Output window	2-40
Table 2-30: Menu selection	2-41
Table 2-31: Time Base Window operation	2-43
Table 2-32: Timing, Level, Data-Listing Window operation	2-45
Table 2-33: Data-Listing, Data-Waveform Window operation	2-46
Table 2-34: Channel Group Window operation	2-48
Table 2-35: Sequence Window operation	2-49

Table 2-36: Example of Numeric Keys input 2-50
Table 2-37: Example of Numeric Keys input 2-51
Table 2-38: Selecting a file 2-52
Table 2-39: Key operations 2-53

Table 3-1: The number of available physical channels 3-2

Table 4-1: Main sequence 4-35

General Safety Summary

Review the following safety precautions to avoid injury and prevent damage to this product or any products connected to it. To avoid potential hazards, use this product only as specified.

Only qualified personnel should perform service procedures.

To Avoid Fire or Personal Injury

Use Proper Power Cord. Use only the power cord specified for this product and certified for the country of use.

Ground the Product. This product is grounded through the grounding conductor of the power cord. To avoid electric shock, the grounding conductor must be connected to earth ground. Before making connections to the input or output terminals of the product, ensure that the product is properly grounded.

Observe All Terminal Ratings. To avoid fire or shock hazard, observe all ratings and markings on the product. Consult the product manual for further ratings information before making connections to the product.

The common terminal is at ground potential. Do not connect the common terminal to elevated voltages.

Do not apply a potential to any terminal, including the common terminal, that exceeds the maximum rating of that terminal.

Do Not Operate Without Covers. Do not operate this product with covers or panels removed.

Avoid Exposed Circuitry. Do not touch exposed connections and components when power is present.

Do Not Operate With Suspected Failures. If you suspect there is damage to this product, have it inspected by qualified service personnel.

Do Not Operate in Wet/Damp Conditions.

Do Not Operate in an Explosive Atmosphere.

Keep Product Surfaces Clean and Dry.

Provide Proper Ventilation. Refer to the manual's installation instructions for details on installing the product so it has proper ventilation.

Symbols and Terms **Terms in this Manual.** These terms may appear in this manual:



WARNING. *Warning statements identify conditions or practices that could result in injury or loss of life.*



CAUTION. *Caution statements identify conditions or practices that could result in damage to this product or other property.*

Terms on the Product. These terms may appear on the product:

DANGER indicates an injury hazard immediately accessible as you read the marking.

WARNING indicates an injury hazard not immediately accessible as you read the marking.

CAUTION indicates a hazard to property including the product.

Symbols on the Product. The following symbols may appear on the product:



WARNING
High Voltage



Protective Ground
(Earth) Terminal



CAUTION
Refer to Manual



Double
Insulated

Preface

This is the user manual 1 for the DTG5000 Series Data Timing Generator. It covers the following information:

- Describes the capabilities of the data timing generator, how to install it and reinstall its software.
- Provides tutorials to familiarize the user with two basic operation modes. The pulse generator mode and data generator mode.
- Lists standard and optional accessories and instrument options available for the data timing generator.

About This Manual

This manual is composed of the following sections:

- *Getting Started* shows you how to configure and install your data timing generator and provides instrument options and accessories list.
- *Operating Basics* describes the data timing generator instrument controls including rear panel connectors. It also provides information on the data timing generator screen elements.
- *Data Structure* describes the concept of data timing generator pattern data.
- *Tutorials* provides simplified application examples, which show you how to create/edit the pattern data.

Related Manuals and Online Documents

This manual is part of a document set of manuals and online documentation. This manual mainly focuses on installation, background, and user information needed to use the product features. See the following list for other documents supporting the data timing generator operation and service. (Manual part numbers are listed in *Accessories & Options* on page 1-20.)

Document name	Description
<i>DTG5000 Series Online Help</i>	An online help system, integrated with the User Interface application that ships with this product. The help is preinstalled in the data timing generator.
<i>DTG5000 Series User Manual 2</i>	A reference provides an encyclopedia of topics that describe the data timing generator interface and features, and gives background information on how to use them. (Product Documents CD)
<i>DTG5000 Series Programmer Manual</i>	Provides complete information on programming commands and remote control of the instrument. (Product Documents CD)
<i>DTG5000 Series Technical Reference for Performance Verification & Specifications</i>	Describes how to verify the performance of the data timing generator and lists its specifications.
<i>DTG5000 Series Service Manual</i>	Describes how to service the data timing generator to the module level. This optional manual must be ordered separately.

Contacting Tektronix

Phone	1-800-833-9200*
Address	Tektronix, Inc. Department or name (if known) 14200 SW Karl Braun Drive P.O. Box 500 Beaverton, OR 97077 USA
Web site	www.tektronix.com
Sales support	1-800-833-9200, select option 1*
Service support	1-800-833-9200, select option 2*
Technical support	Email: techsupport@tektronix.com 1-800-833-9200, select option 3* 6:00 a.m. - 5:00 p.m. Pacific time

* **This phone number is toll free in North America. After office hours, please leave a voice mail message. Outside North America, contact a Tektronix sales office or distributor; see the Tektronix web site for a list of offices.**



Getting Started

Product Description

This section describes the DTG5000 Series Data Timing Generators and their options. Following this description are two subsections:

- *Installation* shows you how to configure and install the data timing generator, as well as how to reinstall the system software included with the product.
- *Accessories & Options* lists the standard and optional accessories for this product.

Models

This manual supports the following data timing generators:

- DTG5078 Data Timing Generator
- DTG5274 Data Timing Generator
- DTG5334 Data Timing Generator

The differences between the data timing generators will be called out when necessary; otherwise, the material applies to all data timing generators. The term “data timing generator” refers to all of the products.

Key Features

The DTG5000 Series Data Timing Generator is a high-speed, multichannel signal generator that creates a wide range of digital timing signals. The products are designed to generate a data pattern for standard and nonstandard pulses necessary for functional tests or characterization of legacy devices (TTL, CMOS, ECL) as well as the latest devices (PECL, LVDS, GTL, CML).

Use the DTG5000 series to insert glitches and jitter as needed, and easily create patterns for device stress testing. In addition, to shorten testing time, use the sequence function to create signal sequences from combinations of various patterns.

The DTG5000 Series Data Timing Generator supports six types of output modules (DTGM10, DTGM20, DTGM21, DTGM30, DTGM31 and DTGM32). Table 1-1 lists the key features of the data timing generators, and Table 1-2 lists the key features of the output modules.

Table 1-1: DTG5000 series key features

	DTG5078	DTG5274	DTG5334
Maximum clock frequency/Maximum data rate	750 MHz/750 Mb/s	2.7 GHz /2.7 Gb/s	3.35 GHz /3.35 Gb/s
Number of slots	8 (A, B, C, D, E, F, G, and H)	4 (A, B, C, and D)	4 (A, B, C, and D)
Pattern length	240 to 8,000,000 words/channel	960 to 32,000,000 words/channel	960 to 64,000,000 words/channel
Block size granularity	1	1 to 4 (depends on Vector Rate)	1 to 4 (depends on Vector Rate)
Sequence steps	1 to 8,000 steps	1 to 8,000 steps	1 to 8,000 steps
Sequence repeat counter	1 to 65,536 or Infinite	1 to 65,536 or Infinite	1 to 65,536 or Infinite
Master-Slave	Up to three (one Master, two Slaves)	Up to two (one Master, one Slave)	Up to two (one Master, one Slave)
Data Generator Mode	Slot A, B, C, D, E, F, G, and H	Slot A, B, C, and D	Slot A, B, C, and D
Data format			
Slot A to D	NRZ, RZ, and R1	NRZ, RZ, and R1	NRZ, RZ, and R1
Slot E to H	NRZ		
Data rate			
NRZ	50 kb/s to 750 Mb/s	50 kb/s to 2.7 Gb/s	50 kb/s to 3.35 Gb/s
RZ and R1	50 kb/s to 375 Mb/s	50 kb/s to 1.35 Gb/s	50 kb/s to 1.675 Gb/s
Channel addition	Slot A, B, C, and D	Slot A, B, C, and D	Slot A, B, C, and D
Jitter generation	Channel 1 of slot A	Channel 1 of slot A	Channel 1 of slot A
Lead delay resolution	1 ps	0.2 ps	0.2 ps
Trail delay resolution	5 ps	5 ps	5 ps
Pulse width resolution	5 ps (slot A, B, C, and D)	5 ps (slot A, B, C, and D)	5 ps (slot A, B, C, and D)
Pulse Generator Mode	Slot A, B, C, and D	Slot A, B, C, and D	Slot A, B, C, and D
Clock frequency	50 kHz to 375 MHz	50 kHz to 1.35 GHz	50 kHz to 1.675 GHz

Table 1-2: DTG5000 series Output module key features

	DTGM10	DTGM20	DTGM21	DTGM30	DTGM31	DTGM32
Number of channels	4	4	4	2	1	1
Number of available channels						
DTG5078	4	4	4	2	1	1
DTG5274	2 (CH1, CH2)	2 (CH1, CH2)	2 (CH1, CH2)	2	1	1
DTG5334	2 (CH1, CH2)	2 (CH1, CH2)	2 (CH1, CH2)	2	1	1
Amplitude (50 Ω)	3.5 V _{p-p}	3.5 V _{p-p}	3.90 V _{p-p} (50 Ω) 5.35 V _{p-p} (23 Ω)	1.25 V _{p-p}	1.25 V _{p-p}	1.25 V _{p-p}
Amplitude (1 M Ω)	10 V _{p-p}	7 V _{p-p}	7.81 V _{p-p}	2.5 V _{p-p}	2.5 V _{p-p}	2.5 V _{p-p}
Rise time/ fall time at 1 V _{p-p} into 50 Ω (20% to 80%)	<540 ps (variable)	<340 ps (variable)	<350 ps	<110 ps	<110 ps	<110 ps
Hi Z Control			yes			
External Jitter Input					yes one Input	yes two Input

Mainframe and Output Module Configuration

The DTG5000 Series Data Timing Generator offers modular card system. Six types of the output modules can be combined in any combination. Each module can be inserted into any slot. The functional restrictions are:

- 8 slots installed in the DTG5078 (A, B, C, D, E, F, G, and H)
- 4 slots installed in the DTG5274 and DTG5334 (A, B, C, and D)
- When the DTGM10, DYGM20, or DTGM21 is installed on the DTG5274 or DTG5334, CH3 and CH4 are not available. Only CH1 and CH2 can be used.
- Slot E, F, G, and H are not available in the Pulse Generator mode.
- Available data formats are different:
 - NRZ, RZ, R1 (Slot A, B, C, and D)
 - NRZ (Slot E, F, G, and H)
- Due to power consumption constraints, the output modules used with the DTG5078 are limited as follows:
 - Utilizing the power consumption figures for each installed output module [P(Mxx) in Table 1-3], the sum of all P(Mxx) values must not exceed 100.

Table 1-3: Current consumption coefficient

	Current consumption coefficient
DTGM10	P(M10) = 9
DTGM20	P(M20) = 10
DTGM21	P(M21) = 10
DTGM30	P(M30) = 8
DTGM31	P(M31) = 33
DTGM32	P(M32) = 32

Example 1: DTGM31 1each, DTGM30 7each
 $P(M31) + P(M30) \times 7 = 33 + 8 \times 7 = 89 < 100$; Acceptable

Example 2: DTGM32 3each, DTGM30 5each
 $P(M32) \times 3 + P(M30) \times 5 = 32 \times 3 + 8 \times 5 = 136 > 100$; Not Acceptable

Product Software

The data timing generator includes the following software:

- The system software, which includes a specially configured version of Windows 2000, comes preinstalled on the data timing generator. Windows 2000 is the operating system on which the user-interface application of this product runs, and provides an open desktop for you to install other compatible applications.

NOTE. Do not attempt to substitute any version of Windows that is not specifically provided by Tektronix for use with this instrument.

- The DTG5000 Software comes preinstalled on the data timing generator. This software, runs on Windows 2000, is the data timing generator application. This software starts automatically when the data timing generator is powered on, and provides the user interface (UI) and all other instrument control functions. You can also minimize the data timing generator application.
 - The product software runs not only on the data timing generator mainframe, but also on the general PC. When the software runs on the data timing generator mainframe, it is called the *Online mode*. While running on the PC, it is called the *Offline mode*. In the Offline mode, it is possible to create and edit the pattern data and set the output parameters.
- The DTG5000 Configuration Utility comes preinstalled on the data timing generator. This software, running on Windows 2000, is used for setting up the system configurations for the DTG5000 Software. This software controls the Master operation, Master/Slave operation, Online/Offline operation, and so forth.

NOTE. When you use the DTG5000 software with the offline mode, you must also install the DTG5000 Configuration Utility into your PC.

- The Readme file contains release notes and updates that could not be included in other product documentation.
- There are no limits on number of PCs that can operate in the offline mode.

Occasionally new versions of software for your instrument may become available at our web site. See *Contacting Tektronix* on page xi in the *Preface* section for web site information.

Software Upgrade

Tektronix may offer software upgrade kits for the data timing generator. Contact your Tektronix service representative for more information (see *Contacting Tektronix* on page xi).

Installation

This section covers installation of the data timing generator, addressing the following topics:

- *Unpacking* on page 1-7
- *Checking the Environmental Requirements* on page 1-8
- *Output Module* on page 1-9
- *Connecting to a Network* on page 1-10
- *Connecting Peripherals* on page 1-11
- *Powering On the Data Timing Generator* on page 1-12
- *Setting up Windows 2000* on page 1-13
- *Shutting Down the Data Timing Generator* on page 1-14
- *Creating an Emergency Rescue Disk* on page 1-16
- *Backing Up User Files* on page 1-18
- *Installing Software* on page 1-18



CAUTION. *Be sure to create your emergency rescue disk as described on page 1-16. You may need that disk if you ever need to reinstall Windows 2000 from the data timing generator hard drive.*

Unpacking

Verify that you have received all of the parts of your data timing generator. The packing list shows the standard accessories that you should find in the shipping carton. The output modules are not shipped within the mainframe carton. You should also verify that you have:

- The correct power cord for your geographical area
- Two compact discs that include copies of the software installed on the data timing generator and additional support software that may be useful to you. Store the product software in a safe location where you can easily retrieve it.
 - Recovery disk for Microsoft Windows (R) 2000 Professional
 - DTG5000 Series Product Software

NOTE. *The certificate of authenticity (Microsoft Windows 2000 licence agreement) is attached to your data timing generator. This certificate proves your ownership of the Windows operating system in your mainframe. Without this certificate, you might have to purchase a new Windows license if the hard disk in your mainframe ever needs rebuilding or replacement.*

- All the standard and optional accessories that you ordered
- Output module(s) you ordered

Remember to fill out and send in the customer registration card. The registration card is packaged with this manual.

Checking the Environmental Requirements

Read this section before attempting any installation procedures. This section describes site considerations and power requirements for your data timing generator.

Site Considerations

The data timing generator is designed to operate on a bench in the normal position (on the bottom feet). For proper cooling, at least three inches (7.62 cm) of clearance is required on both sides of the data timing generator, and the bottom requires the clearance provided by the mainframe feet.

If you operate the data timing generator in the Master-Slave mode, you can stack up to two mainframes.



CAUTION. *To avoid damage to the mainframe, always close the bottom stands when you stack the mainframes.*

Using a cart is not recommended when you stack the mainframes. Doing so could result in serious damage to the cart or mainframes.

Do not operate the mainframe while it rests on its left side feet. Always place the mainframe in the normal position (on the bottom feet) while the mainframe is powered-on.

Operating Requirements

Table 1-4 shows general operating requirements for the data timing generator. For more information, refer to *Technical Reference for Performance Verification & Specifications*. It covers power source, temperature, humidity, and altitude information.

Table 1-4: Operating requirements

Item	Description
Operating temperature	+10°C to +40°C
Operating relative humidity	20% to 80% (No condensation)
Operating altitude	Up to 3 km (10,000 ft)
Power supply	
Rating voltage	100 V to 240 V
Voltage range	90 V to 250 V
Frequency	47 Hz to 63 Hz
Maximum power	600 VA maximum

NOTE. Also in rack-mounted use, operating requirements are the same. Be careful of the temperature inside a rack.

Output Module

The DTG5000 Series Data Timing Generator mainframe and output module(s) are shipped separately. At least one output module must be installed in the mainframe slot to operate properly.

Six types of output modules can be combined in any combination. Each module can be inserted in any slot. There are functional differences between slot A to D and slot E to H. (Refer to *Mainframe and Output Configuration* on page 1-4.) It is recommended that slot A should be used when only one output module is installed in the mainframe slot.

Installing the Output Module

To install the output module, first power off the mainframe using the front panel On/Standby switch.

1. Verify that the data timing generator mainframe is not powered on.
2. Remove the blank panel from the mainframe slot.
3. Place the output module in a compartment.
4. Gently push the output module into the slot with firm pressure.
5. Once the module is seated, tighten the two screws with a screwdriver to secure the module to the mainframe.



CAUTION. To prevent damage to the output module or mainframe, never install or remove the output module when the mainframe is powered on.

Some output modules get quite hot during operation. After powering off the data timing generator, wait several minutes before attempting to remove the output module.

Avoid touching the board surface or connectors of the output module with your fingers when you handle the module.

Attach the blank panel to the mainframe module slot(s) when the output module(s) are not installed.

If the output module is not in use for a long time, attach the connector caps and SMA terminations (DTGM30, DTGM31, and DTGM32) to the output module and then store the output module in the shipping carton in a ESD-protective bag. The connector caps and SMA terminations are provided with your output module.

Removing the Output Module

Verify that the data timing generator mainframe is not powered on.

1. Loosen the two screws.
2. Grasp the right and left screws and slowly pull the module out of the mainframe slot.
3. Attach a blank panel to the slot.

Connecting to a Network

You can connect the data timing generator to a network to enable printing, file sharing, internet access, and other communications functions. In the Master-Slave mode, the slave mainframe is controlled by the Master-mainframe connection between the mainframes. Before you use the Master-Slave mode, connect each mainframe to a network. Refer to page 2-12 for more information explaining Master-Slave connections. Also see Figure 2-7 on page 2-11:Rear panel connectors.

Connect the network cable to the mainframes before power-on.

The factory default computer name of the DTG5000 series is “DTG5000”. Before connecting multiple DTG5000 series units to a network, each must be assigned a unique computer name. The procedure for changing the computer name is described in the “Master-Slave Operation” section in the User Manual 2.

Connecting Peripherals

The peripheral connections are the same as those you would make on a personal computer. The connection points are shown in Figure 1-1. See Table 1-5 for additional connection information.

Connect the supplied mouse and keyboard to the USB connectors. Most DTG5000 series operations can be performed using the front panel controls, but may be easier using the mouse and keyboard.



CAUTION. To avoid product damage, power off the data timing generator or place the data timing generator in Standby power mode before installing any accessories except a USB mouse or a USB keyboard to the mainframe connectors. (You can connect or disconnect USB devices while powering on the mainframe.) See Powering Off the Data Timing Generator on page 1-14.

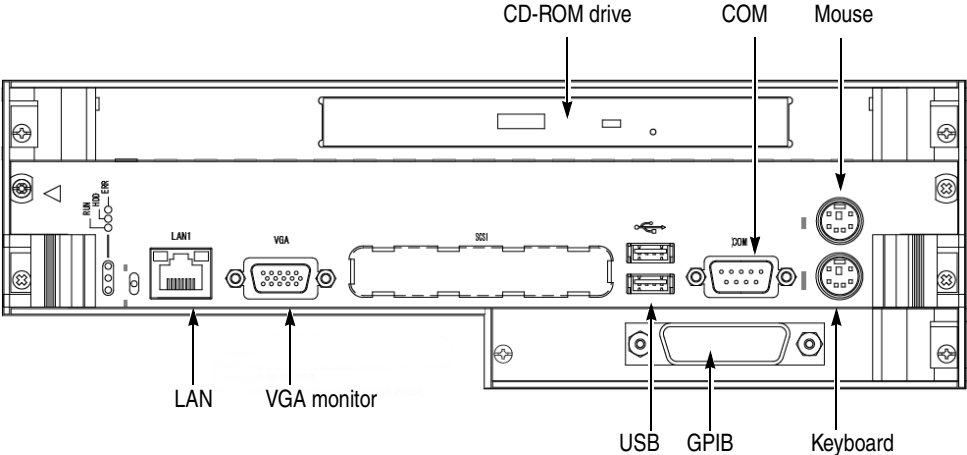

Figure 1-1: Locations of peripheral connectors on rear panel

Table 1-5: Additional connection information

Item	Description
Monitor	If you use an external monitor with the data timing generator mainframe screen, the resolution of the external monitor is fixed to 800 x 600. If you select the external monitor only, high resolution display is possible. You can set the resolution by using the Windows 2000 control panel.
Printer	If you connect the printer directly to the data timing generator, connect the USB printer to a USB connector port of the mainframe. You cannot connect the parallel printer directly to the mainframe. If your data timing generator is connected to LAN, you can use a network printer.

Powering On the Data Timing Generator

Follow these steps to power on the data timing generator. Refer to page 1-13 for Windows 2000 setup.

1. Connect the proper power cord from the rear panel power connector to the power system.

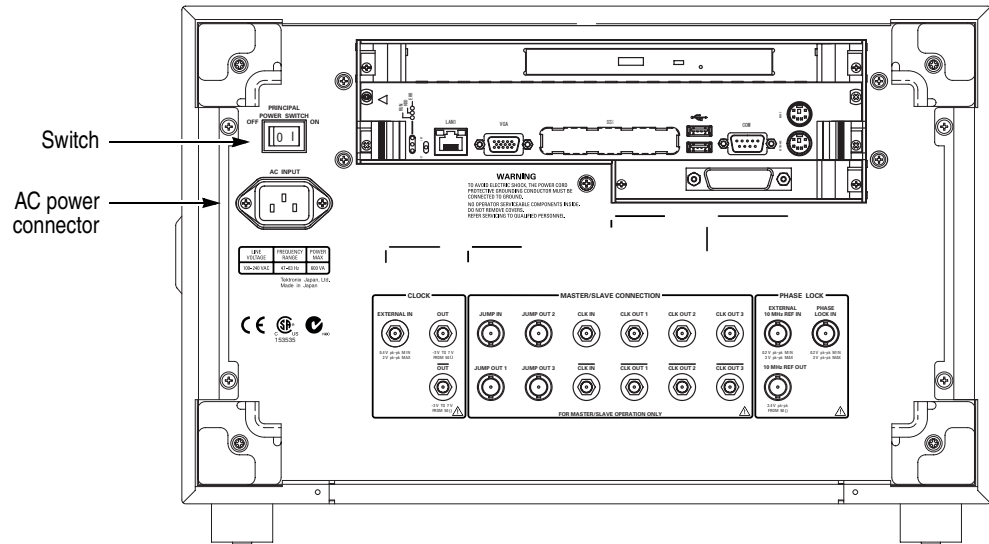

Figure 1-2: Principal power switch and AC power connector

NOTE. To set up Windows 2000, connect the keyboard and mouse before turning the power on. Connect the keyboard, mouse, and other accessories before applying power to the product.

1. Turn on the principal power switch at the rear panel. (See Figure 1-2 for switch location.)
2. Push the front panel On/Standby switch to power on the data timing generator (see Figure 1-3 for the switch location).

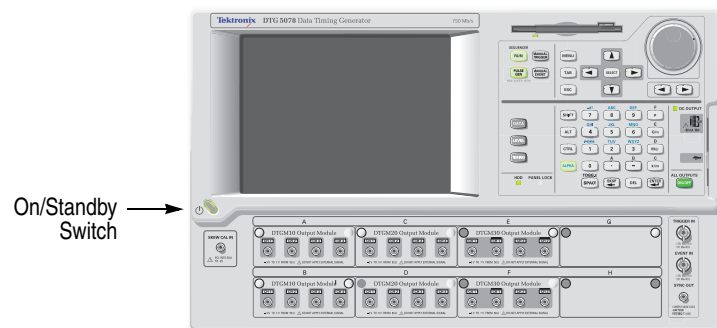

Figure 1-3: On/Standby switch location

Setting up Windows 2000

You need to set up Windows 2000 when you first power on the data timing generator.

NOTE. *Connect the keyboard and mouse before powering on the mainframe when you set up Windows 2000.*

1. Attach the standard accessory USB mouse and USB keyboard to the data timing generator mainframe. Three USB connector ports are equipped with the mainframe (two on the rear panel and one on the front right side).
2. Push the front panel On/Standby switch to power on the mainframe.
3. The Windows 2000 setup wizard appears on the data timing generator screen.
4. Follow the on-screen instructions.
5. When the **Your Product Key** dialog box appears, enter the bar code number which is located at the rear panel of the mainframe.
6. Click the **Next** button to display the **Date and Time Settings** dialog box.
7. Confirm that the Date and Time Settings information is correct, and click the **Next** button.
8. A dialog box pops up to let you know that the Windows 2000 setup has been completed.
9. Click **Restart Now**, and Windows runs.

The computer name is DTG5000, and you can log on to Windows 2000 with the following user name and password.

- User name: Administrator
- Password: dtg5000

If you want to add a user name, or want to change the password, always use the **Control Panel > Users and Passwords**. For more information, consult Windows 2000 Help.

NOTE. *If you connect a second or third DTG5000 Series Data Timing Generator to the network, use different computer names for additional mainframes.*

Powering Off the Data Timing Generator

When you push the front-panel On/Standby switch, the data timing generator starts a shutdown process (including a Windows shutdown) to preserve settings. This action removes power from most circuitry in the data timing generator. Avoid using the rear panel power switch or disconnecting the line cord to power off the mainframe.

The DTG5000 Series Data Timing Generator runs on Windows 2000; the shut down process is similar to a PC.

There are three ways to shut down the mainframe:

- Push the On/Standby switch.
- Select the Windows **Start** menu, and then select **Shut Down....**
- Select the **File** menu from the DTG5000 software, then select **Shutdown.**

If the data timing generator settings were not changed. When the DTG5000 software is not running, or if the data timing generator settings have not changed since the mainframe start-up, the shut down process closes all the programs on Windows and then restores the settings. The power is automatically shut off.

If the data timing generator settings were changed. If the DTG5000 Series Data Timing Generator settings were changed after the mainframe start-up. The dialog box shown below appears on the screen and asks if you want to save the current settings. Push any button within five seconds.

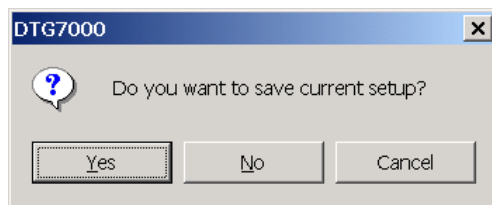

- Select **Yes** to specify the file name and location, and then select **OK** to continue the shut down process.
- Select **No** without saving the setup file and continue the shut down process.
- Select **Cancel** to abort the shut down process and to return to the DTG5000 software.

If you do not select a button within five seconds, Windows terminates the DTG5000 software. The **End Program** dialog box appears.

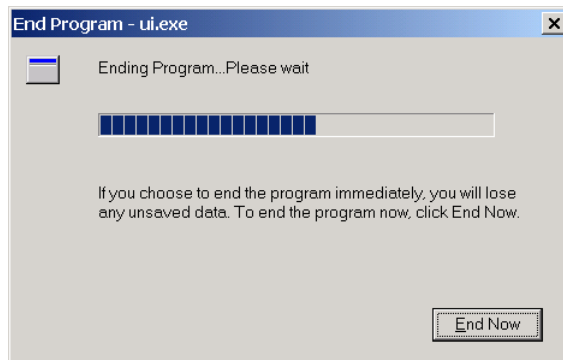

- Select **End Now** to continue the shut down process without saving the setup file.

Without any action in ten seconds, the following dialog box appears.

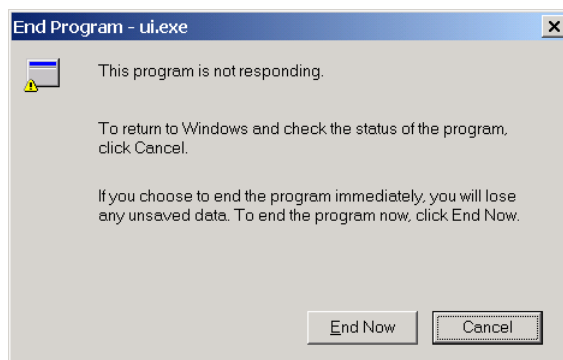

The DTG5000 software is waiting for the information about whether you want to save the setup information. In this case, Windows cannot terminate the DTG5000 software.

- Select **End Now** to continue the shut down process without saving the setup file.
- Select **Cancel** to return to the DTG5000 software.

In all cases, select **End Now** to exit all the Windows programs while preserving the current Windows setting. This shuts off the power to the mainframe.

To completely remove the power from the data timing generator, perform the shutdown described above. Shut off the principal power switch at the rear panel, and then disconnect the power cord from the mainframe.

NOTE. If you push the front panel On/Standby switch for more than four seconds, the data timing generator power is forced to be shut off.

Do not attempt to push the rear panel principal power switch before shutting down the mainframe properly.

Creating an Emergency Rescue Disk

Now that you have completed the basic installation process, you should create an emergency rescue disk that you can use to restart your data timing generator in case of a major hardware or software failure.

NOTE. Create the emergency rescue disk and store it in a safe place. It may allow you to recover your Windows 2000 installation without rebuilding the entire data timing generator hard disk.

The emergency rescue disk contains basic files to restart your data timing generator. Follow these steps to create the emergency rescue disk:

1. Log on to the mainframe with the administrator name. Refer to page 1-13.
2. Click the Windows **Start** button, select **Program > Accessories > System Tools > Backup**. The following dialog box appears.



3. Insert a formatted floppy disk into the floppy disk drive, and then click **Emergency Repair Disk**.

4. The **Emergency Repair Diskette** dialog box appears.

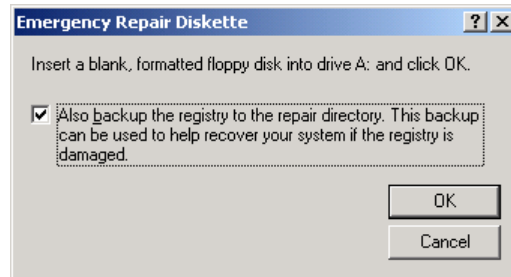

5. Click **Also backup the registry...**, and then click **OK**.
6. Wait until the task completes. The dialog box appears.
7. Click **OK**, then remove the floppy disk and store it at a safe place.

Backing Up User Files

You should always back up your user files on a regular basis. Use the Back Up tool to back up files stored on the hard disk. The Back Up tool is located in the System Tools folder in the Accessories folder.

1. Log on to the mainframe with the administrator name. Refer to page 1-13.
2. Click the Windows **Start** button, select **Program > Accessories > System Tools > Backup**.
3. Click **Backup Wizard**.
4. Follow the on-screen instructions.

The backup tool allows you to select your backup media and to select the files and folders that you want to back up. Use the Windows online help for information on using the Backup tool. You can back up to the floppy drive or to a third-party storage device.

Installing Software

The data timing generator mainframe ships with the product software installed, so only perform the reinstallation if it becomes necessary. For more information on the software reinstallation, refer to the User Manual 2.

System Diagnostics

In case of instrument problems, you may wish to run the system diagnostics. See the related manual (*Technical Reference for Performance Verification and Specifications*) for more information on self tests and system diagnostics.

Accessories & Options

This section lists the standard and optional accessories available for the DTG5000 Series Data Timing Generator as well as the product options.

Options

The following instrument options can be ordered for the instrument.

Table 1-6: Instrument options

Option	Description
Mainframe (DTG5078/DTG5274/DTG5334)	
Option D1	Certificate with Calibration Data
Option 1R	Rackmount kit
Output Module (DTGM10/DTGM20/DTGM21/DTGM30/DTGM31/DTGM32)	
Option D1	Certificate with Calibration Data

Power Cord Options

The following power cord options are available for the instrument.

Table 1-7: Power cord options

Option	Area	Tektronix part number
A0	North America	161-0230-01
A1	Universal European	161-0104-06
A2	United Kingdom	161-0104-07
A3	Australian	161-0104-05
A5	Switzerland	161-0167-00
A6	Japan	161-A005-00
A10	China	161-0306-00
A99	No power cord	---

Language Options

The following two language options are provided for the data timing generator documents. You must specify a language option when you place an order.

Table 1-8: Language options

Option	Descriptions	Part number
L0: DTG5078, DTG5274	English manuals	
	User Manual volume 1	071-1281-xx
	User Manual volume 2	071-1282-xx
	Programmer Manual	071-1283-xx
L0: DTG5344	English manuals	
	User Manual 1	071-1608-xx
	Technical Reference for Performance Verification and Specifications	071-1611-xx
	Product Documents CD (includes all pdf files:User Manual 2, Programmer, User Manual 1, Technical Reference manuals)	063-3833-xx
L5: DTG5078, DTG5274	Japanese manuals	
	User Manual volume 1	071-1277-xx
	User Manual volume 2	071-1278-xx
	Programmer Manual	071-1279-xx
L5	Japanese manuals	
	User Manual 1	071-1612-xx
	Technical Reference for Performance Verification and Specifications ¹	071-1611-xx
	Product Documents CD (includes all pdf files:User Manual 2, Programmer, User Manual 1, Technical Reference manuals)	063-3833-xx

¹ This manual is provided in English only.

Accessories

This section lists the standard and optional accessories available for this data timing generator.

Standard The following accessories are shipped with the data timing generator:

Table 1-9: Standard accessories

Accessory	Part number
Mainframe	
User Manual 1	See Table 1-8 for part number.
Technical Reference for Performance Verification and Specifications	
Product Documents CD (includes all pdf files: User Manual 2, Programmer, User Manual 1, Technical Reference manuals)	
Windows © 2000 Professional Operating System Recovery Disk DTG5334 DTG5724, DTG5078	063-3811-xx 062-A300-xx
DTG5000 series Product Software Disc DTG5334 DTG5274, DTG5078	063-3812-xx 062-A301-xx
USB Keyboard	119-B146-00
USB Mouse	119-B145-00
Lead Set for DC Output 16-CON twisted pair, 60 cm (24 in)	012-A229-00
Front Cover	200-4651-00
Accessory Pouch	016-1441-00
50 Ω SMA Termination, Male, DC-18 GHz	015-1022-01
Ten SMA Connector Caps (DTG5078)	200-A531-00
Eight SMA Connector Caps (DTG5274, DTG5334)	200-A531-00
Output Module	
Installation Manual	071-1616-xx
Notice Sheet	061-4292-xx
Windows © 2000 Professional Operating System Recovery Disk DTG5000 series Product Software Disc Product Documents CD (DTGM21, DTGM31, DTGM32)	063-3811-xx 063-3812-xx 063-3833-xx
Four SMA Connector Caps (DTGM10, DTGM20, DTGM21)	200-A531-00
Two SMA Connector Caps (DTGM30, DTGM31)	200-A531-00
Three SMA Connector Caps (DTGM32)	200-A531-00
Two 50 Ω SMA Terminations, Male, DC-18 GHz (DTGM30)	015-1022-01
One 50 Ω SMA Termination, Male, DC-18 GHz (DTGM31, DTGM32)	015-1022-01

Optional The accessories in Table 1-10 can be ordered for use with the data timing generator at the time this manual was originally published. Consult a current Tektronix catalog for additions, changes, and details.

Table 1-10: Optional accessories

Accessory	Part number
Service Manual	071-1285-xx
Lead set for DC Output, 16-CON twisted pair, 60 cm (24 in)	012-A229-xx
50 Ω SMA Cable set for 2 units Master-Slave Operation Four 51 cm SMA Cables (174-1427-00) Two 46 cm BNC Cables (012-0076-00)	012-A230-00
50 Ω SMA Cable set for 3 units Master-Slave Operation Six 51 cm SMA Cables (174-1427-00) Three 46 cm BNC Cables (012-0076-00)	012-A231-00
Transition Time Converter, 150 ps	015-0710-00
Transition Time Converter, 250 ps	015-0711-00
Transition Time Converter, 500 ps	015-0712-00
Transition Time Converter, 1000 ps	015-0713-00
Transition Time Converter, 2000 ps	015-0714-00
HDMI TPA-R Test Adapter set Two HDMI TPA-R TDR HDMI TPA-R DI (differential) HDMI TPA-R SE (single end)	013-A012-50
HDMI TPA-P Test Adapter set HDMI TPA-P TDR HDMI TPA-P DI (differential) HDMI TPA-P SE (single end)	013-A013-50
DVI TPA-R Test Adapter set Two DVI TPA-R TDR DVI TPA-R DI (differential) DVI TPA-R SE (single end)	013-A014-50
Pin Header Cable (51 cm, 20 in)	012-1505-00
Pin Header SMB Cable (51 cm, 20 in)	012-1503-00
SMB-BNC Adapter	015-0671-00
GPIB cable (2 m, double-shielded)	012-0991-00
50 Ω BNC Cable (46 cm, 18 in)	012-0076-00
50 Ω BNC Cable (61 cm, 24 in)	012-1342-00

Table 1-10: Optional accessories (cont.)

Accessory	Part number
50 Ω BNC Cable (107 cm, 42 in)	012-0057-01
50 Ω BNC Cable (250 cm, 98 in)	012-1256-00
50 Ω SMA Cable (30 cm, 12 in)	174-1364-00
50 Ω SMA Cable (51 cm, 20 in)	174-1427-00
50 Ω SMA Cable (100 cm, 39 in)	174-1341-00
50 Ω SMA Cable (152 cm, 60 in)	174-1428-00
50 Ω Delay SMA Cable (1 ns, Male to Female)	015-1019-00
50 Ω Delay SMA Cable (2 ns, Male to Male)	015-0560-00
50 Ω Delay SMA Cable (2 ns, Male to Female)	015-1005-00
50 Ω Delay SMA Cable (5 ns, Male to Male)	015-0561-00
50 Ω Delay SMA Cable (5 ns, Male to Female)	015-1006-00
50 Ω SMA Male to BNC Female Adapter	015-0554-00
50 Ω SMA Female to BNC Male Adapter	015-0572-00
50 Ω SMA Male to N Male Adapter	015-0369-00
50 Ω SMA Male to SMA Female Adapter	015-0549-00
50 Ω SMA Female to SMA Slide On Male Adapter	015-0553-00
50 Ω SMA Male to SMA T (Female/Female) Connector	015-1016-00
50 Ω SMA Divider (Fe/Fe/Fe, 6 dB, DC to 18 GHz, VSWR: 1.9)	015-0565-00



Operating Basics

Operating Basics

This section contains information on the various interfaces for controlling the DTG5000 Series Data Timing Generator and basic menu operation of the instrument.

- *Front Panel Controls* on page 2-3 provides a quick overview of front panel controls such as the knob, buttons and keys.
- *Front Panel Connectors* on page 2-5 subsection provides a quick overview of front panel connectors.
- *Rear Panel Connectors* on page 2-9 provides a quick overview of rear panel connectors.
- *Display Area and Application Windows* on page 2-14 describes the overview of screen elements and the application windows.
- *Using the Menu System* on page 2-41 provides an overview of the menu and key operations of the data timing generator.

Front Panel

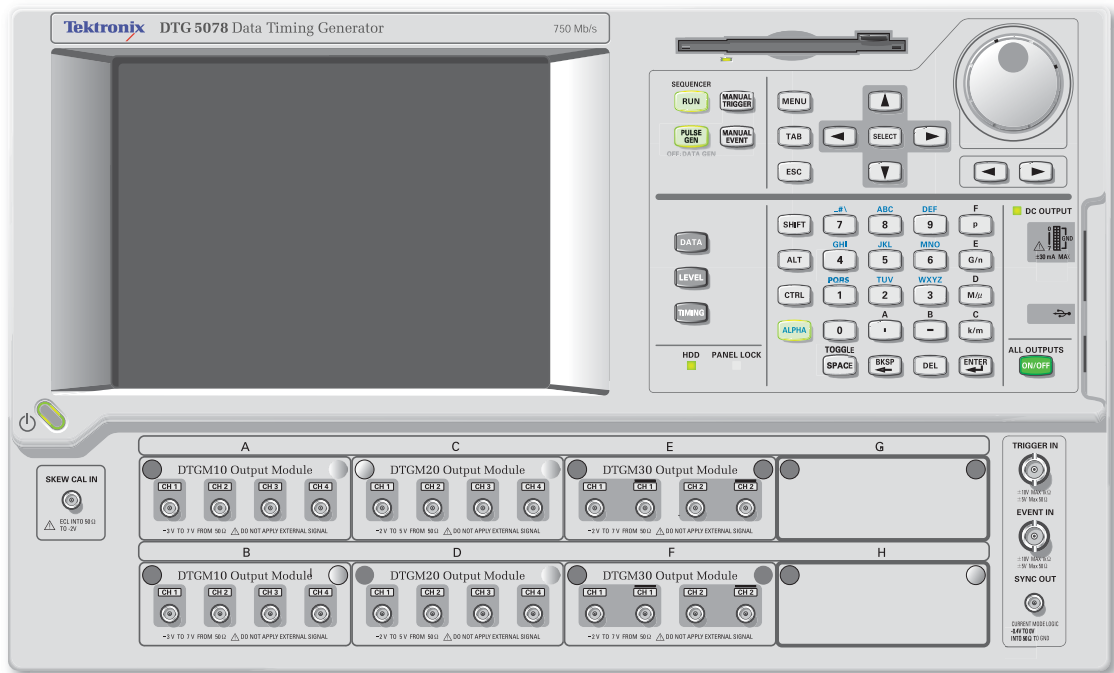

Figure 2-1: Front panel (DTG5078)

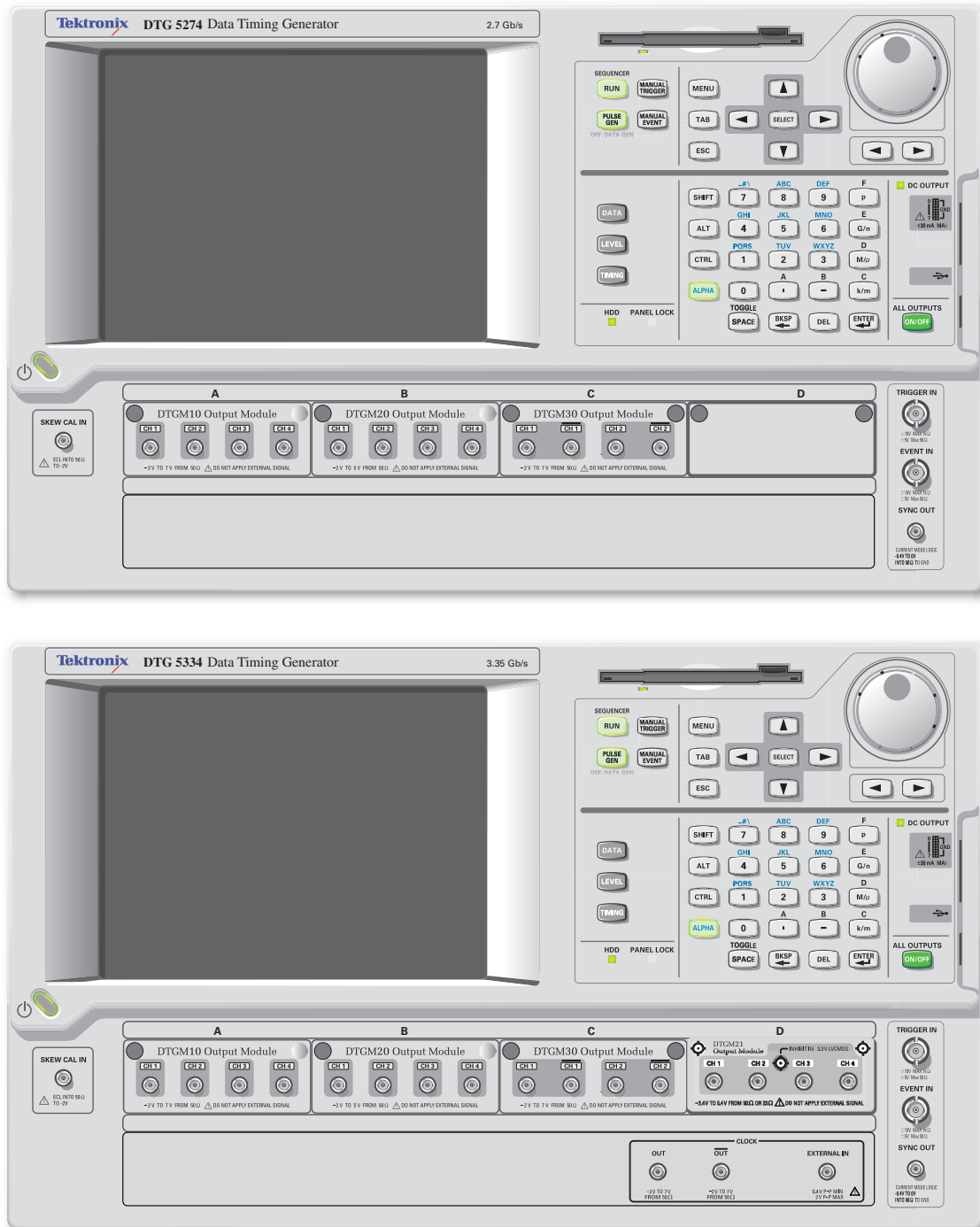

Figure 2-2: Front panel (DTG5274, DTG5334)

Front Panel Controls

This section introduces you to the front panel controls of the data timing generator, which provides a brief overview on how to use the front panel key controls.

In addition to the front panel controls, you can also control the data timing generator from a keyboard and a mouse (provided with the instrument).

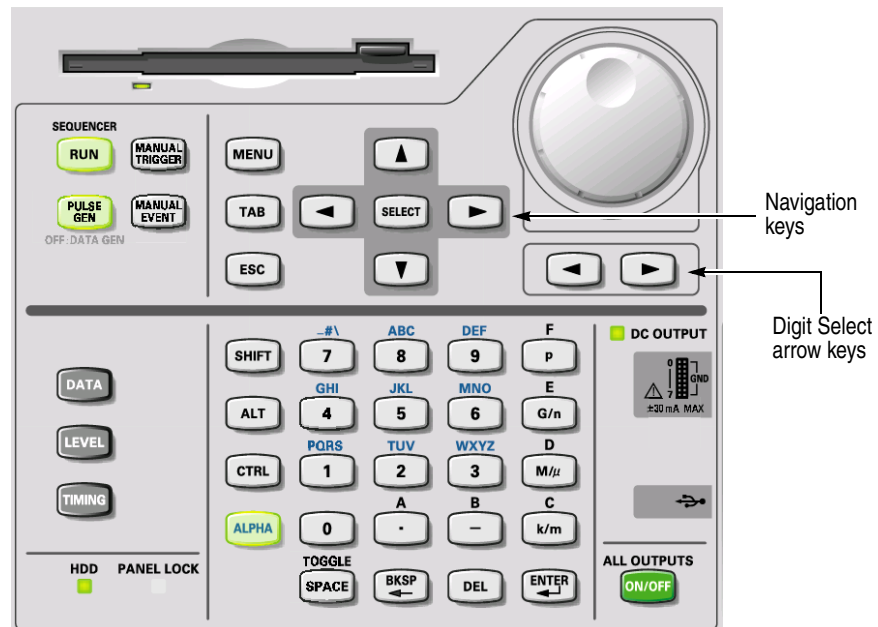

Figure 2-3: Front panel controls

Navigation Keys

The MENU and SELECT buttons, TAB, ESC, and the Up, Down, Left and Right arrow keys are called navigation keys. These buttons and keys allow you to perform the data timing generator basic windows operation without using a mouse or a keyboard. Figure 2-3 shows the locations of the front-panel controls.

Table 2-1: Front panel controls

Key, Button	Description
MENU button 	<p>Opens the pull-down menu items of the last menu bar that you opened, regardless of current selection.</p> <p>To cancel the pull-down menu, push the MENU button again. Pressing the ESC key also forces the pull-down menu to disappear, however the menu bar is still active. If you press any arrow key in this state, the key operates on the menu bar area. Pressing the ESC key twice moves the focus to the lower window area.</p>

Table 2-1: Front panel controls













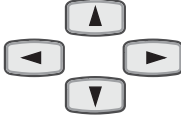





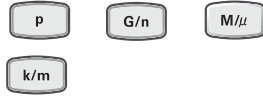

Key, Button	Description
SELECT button 	<ul style="list-style-type: none"> ■ The SELECT button has the same capability as the Windows standard ENTER key. This button is mainly used for the following actions: ■ Use to make a selection on the pull-down menu items ■ Use to open a pop-up menu in a tabular view ■ Use to select an item in a pop-up menu <p>Use to select OK or Cancel in the dialog box</p>
TAB key 	<p>The TAB key is used to move the focus within the window. By pressing the SHIFT and TAB keys simultaneously, you can move the focus in the reverse direction.</p>
ESC key 	<p>The ESC key is used to cancel text input or dialog box appearance. To cancel the menu items opened with the MENU button, press the ESC key twice.</p>
Arrow keys 	<p>The arrow keys are used for the following actions:</p> <ul style="list-style-type: none"> ■ Use to open the pull-down menus on the menu bar and move to the desired items, after pushing the MENU button (you can also use the knob). ■ Use to move the current cell (cursor position) in a tabular view ■ Use to select a radio button <p>The arrow keys have the capability of auto repeat.</p>
DATA button 	<p>Provide direct access to frequently used menus.</p> <p>The DATA button is used to display previously selected pattern data editing window (Data-Listing window or Data-Waveform window). While one window is displayed, pushing this button switches to the alternate window on the screen.</p>
LEVEL button 	<p>Provide direct access to frequently used menus.</p> <p>The LEVEL button is used to display the Level window and moves the focus to the previously selected items.</p>
TIMING button 	<p>Provide direct access to frequently used menus.</p> <p>The TIMING button is used to display the Timing window and moves the focus to the Clock Frequency or previously selected item.</p>
Knob. 	<p>The knob is used to increment or decrement a set value or select an item from a pop-up or pull-down menu. Use right or left arrow keys just under the knob to move the digit when you increment or decrement the setup value.</p>
Digit Select arrow keys 	<p>The Digit Select arrow key is used to move the underbar to a field that contains an editable number. This will allow you to change the digit</p>
RUN button 	<p>The RUN button is used to control the start and stop of signal outputs.</p> <p>If the signal is being output, the LED indicator lights up  . To actually output the signal through the output connectors, you must turn the Output on in the Level window or push the front panel ALL OUTPUTS ON/OFF button.</p>

Table 2-1: Front panel controls

Key, Button	Description
PULSE GEN button 	The PULSE GEN button is used to toggle between Pulse Generator and Data Generator modes. The LED lights up when the instrument is in PG mode.
MANUAL TRIGGER button 	The MANUAL TRIGGER button is used to generate an internal trigger.
MANUAL EVENT button 	The MANUAL EVENT button is used to generate an event signal internally.
Suffix buttons (p, G/n, M/μ, k/m) 	<p>After you complete the input with numeric keys, you can determine the unit by pushing one of the suffix buttons, without pressing the Enter key.</p> <p>If you push a suffix button for a frequency, the unit is interpreted as G (giga-), M (mega-) or k (kilo-). If you push it for a time or voltage, the unit is interpreted as p (pico-), n (nano-), μ (micro-) or m (milli-).</p>
SHIFT key 	The SHIFT key has the same capability as the Shift key on a Windows PC keyboard.
ALPHA key 	<p>The ALPHA key is used to enter a character with a numeric key. Pressing the ALPHA key causes the LED to light up. </p> <p>While the LED is on, the data timing generator is in the text input mode and you can use numeric keys to enter alphanumeric characters.</p>
SPACE key 	The SPACE key switches the On/Off state of a check box. Pressing the ALT and SPACE keys simultaneously displays the Control menu. See <i>DTG icons</i> on page 2-14 for details on the Control menu.
ENTER key 	<p>The ENTER key has the same capability as the Enter key on a Windows PC keyboard</p> <p>This also switches the On/Off state of a check box.</p>
BKSP key 	The BKSP key has the same capability as the Back Space key on a Windows PC keyboard.
DEL key 	The DEL key has the same capability as the Delete key on a Windows PC keyboard.
ALL OUTPUTS ON/OFF button 	<p>This button is used to switch the on/off of channel output, DC output or clock output. To turn on or off of these outputs, use the Level window, DC Output window, or Time Base window, respectively. You can turn on or off the channel (or DC or clock) outputs all together by using this button, instead of switching the on/off separately.</p> <p>If you push this button while at least one active channel or DC output or clock output is on, all the outputs turn off.</p> <p>If you push this button while all the outputs are off, all the outputs turn on.</p> <p>In the Data Generator mode, the physical channels that are not assigned to logic channel do not turn on.</p>

Front Panel Connectors

Figure 2-4 shows the locations of the data timing generator front panel connectors.

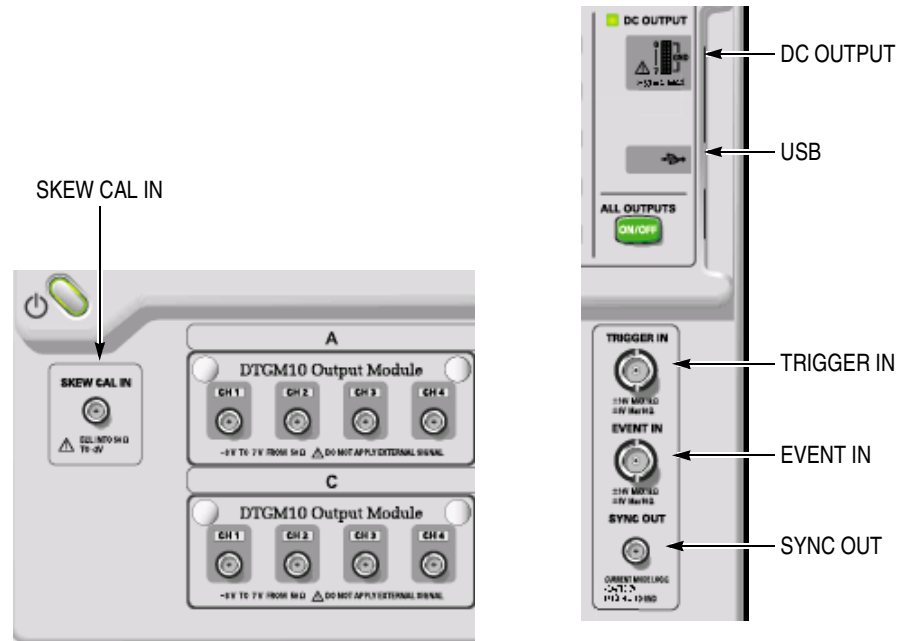

Figure 2-4: Front panel connectors



CAUTION. To prevent damage to your data timing generator, do not apply a voltage outside the specified input voltage range.

Do not apply a voltage to the output connector.

Table 2-2: Front panel connectors

Connector	Description
TRIGGER IN  <small>±10V MAX 1kΩ ±5V Max 50Ω</small>	<p>External trigger signal input connector. Use for Wait Trigger on Sequence operation and for starting trigger of Burst mode on Pulse Generator operation.</p> <p>Input Voltage Range.</p> <ul style="list-style-type: none"> ■ -5 V to +5 V, 50 Ω ■ -10 V to 10 V, 1 kΩ ■ Connector: BNC

Table 2-2: Front panel connectors (cont.)





Connector	Description
<p>EVENT IN</p> 	<p>Event signal input connector. Use for Event Jump on Sequence operation.</p> <p>Input Voltage Range.</p> <ul style="list-style-type: none"> ■ -5 V to +5 V, 50 Ω ■ -10 V to 10 V, 1 kΩ ■ Connector: BNC
<p>SYNC OUT</p> 	<p>Synchronized signal output connector for CML level.</p> <p>Data Generator Mode. A pulse is output at the head of each block of the output pattern. If the block repeats, the pulse is output at each repeated block head.</p> <p>Pulse Generator Mode. Single pulse is output at the timing of Burst. No signal is output in Continuous operation.</p> <ul style="list-style-type: none"> ■ $V_{OH} = 0\text{ V}$, $V_{OL} = -0.4\text{ V}$ into 50 Ω to GND ■ Connector: SMA
<p>SKEW CAL IN</p> 	<p>Signal input connector for adjusting channel-to-channel skews.</p> <p>Input Voltage Level.</p> <ul style="list-style-type: none"> ■ ECL into 50 Ω to -2 V ■ Connector: SMA
<p>CLOCK</p> 	<p>The following external clock input/output signal connectors are equipped in DTG5334.</p> <p>EXTERNAL IN. Connect the external clock input signal.</p> <ul style="list-style-type: none"> ■ Input Voltage Range: 0.4 V_{p-p} to 2 V_{p-p} into 50 Ω ■ Input Frequency Range: DTG5334: 1 MHz to 3.35 GHz <p>OUT, $\overline{\text{OUT}}$. Outputs the clock signal. Amplitude and Offset can be set in the Time Base window.</p> <ul style="list-style-type: none"> ■ Output Voltage Range V_{OH}: -1.00 V to 2.47 V into 50 Ω to GND ■ Output Voltage Range V_{OL}: -2.00 V to 2.44 V into 50 Ω to GND ■ Output Voltage Amplitude: 0.03 V_{p-p} to 1.25 V_{p-p} ■ Resolution: 10 mV ■ Signal type: Complementary ■ Connector: SMA <p>NOTE. A 50Ω SMA termination is provided with your data timing generator mainframe. When you use the instrument with single end, attach the termination to the unused connector.</p>

Table 2-2: Front panel connectors (cont.)

Connector	Description
<p>DC OUTPUT</p> 	<p>Outputs eight channel DC voltage. This signal is independent of the output module signal.</p> <p>Output Voltage Range.</p> <ul style="list-style-type: none"> ■ - 3.0 V to 5.0 V ■ Connector: 2.54 mm 2 x 8 pin header (female)
<p>USB</p> 	<p>Connect a USB device.</p>

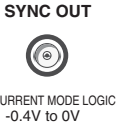
Rear Panel Connectors

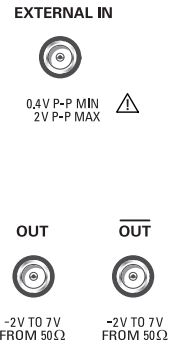
Figure 2-5, Figure 2-6, and Figure 2-7 shows the locations of the data timing generator rear panel connectors.

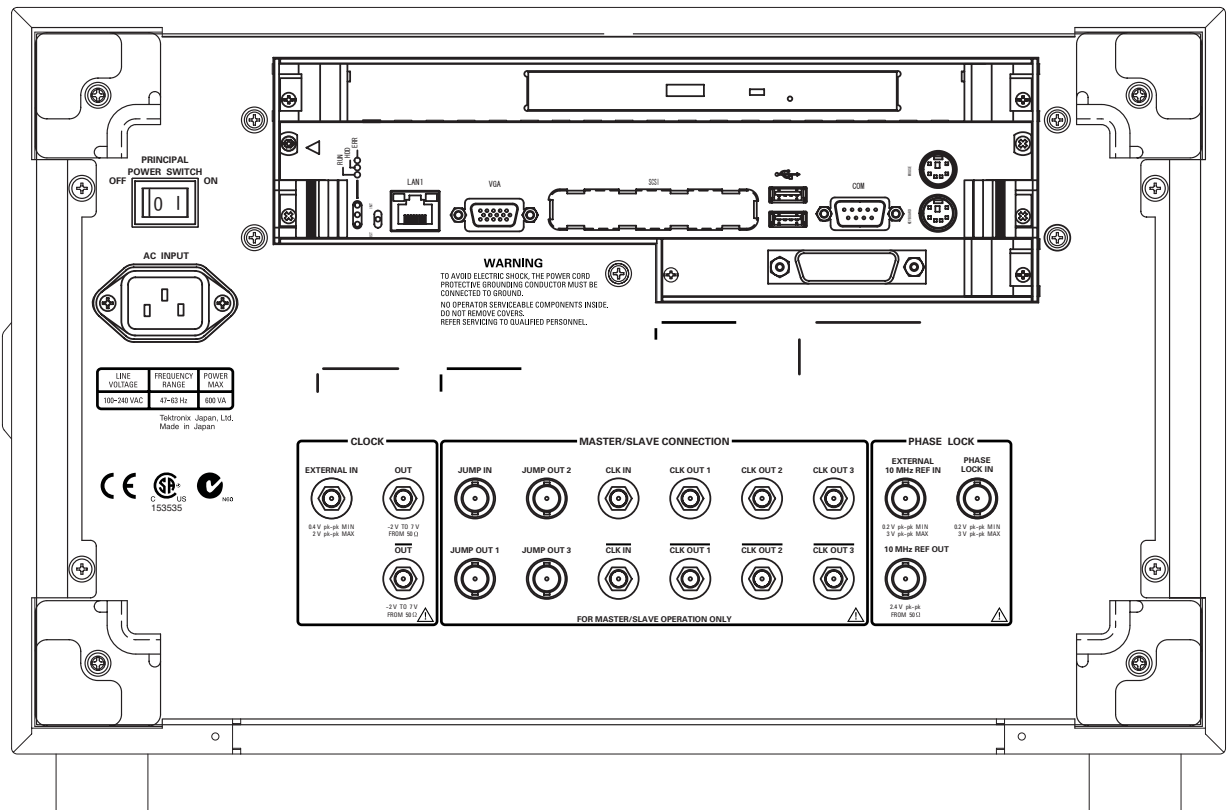

Figure 2-5: Rear panel (DTG5078)

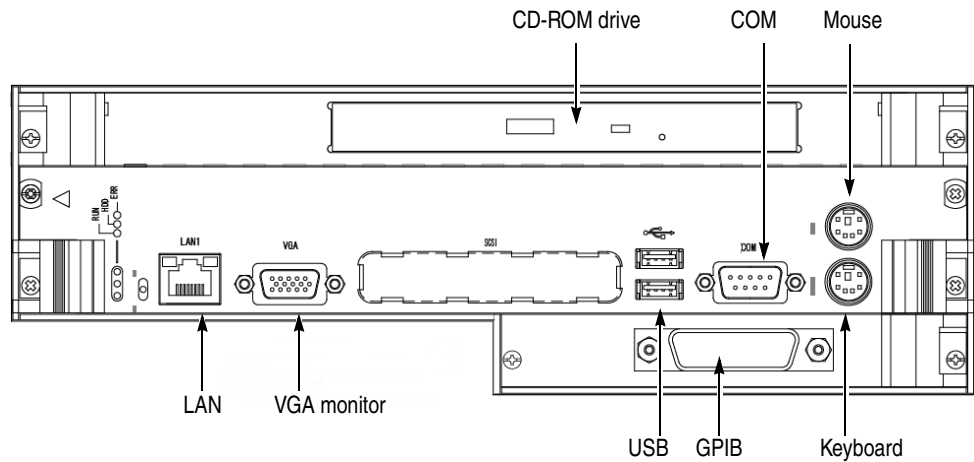

Figure 2-6: Rear panel connectors (1)

Table 2-3: Rear panel connector (1)

	Description
CD-ROM drive	The CD-ROM drive is used to reinstall the DTG5000 product software or to rebuild the operating system.
COM	COM port.
Mouse	Connect a PS/2 mouse. Any USB mouse must be connected to the USB port.
Keyboard	Connect a PS/2 keyboard. By connecting a keyboard and mouse to the connectors, you can perform the Windows PC operations more easily. Any USB keyboard must be connected to the USB port.
GPIB	The GPIB port. Used to control the data timing generator through the GPIB.
USB (2 each)	Connect a USB device. The keyboard and mouse of the data timing generator standard accessories must be connected to the USB port.
VGA	<p>If an external display is connected to this connector, the same image as the data timing generator LCD screen is displayed on it.</p> <p>Resolution Settings.</p> <ul style="list-style-type: none"> ■ The 800 by 600 setting is recommended. ■ It is possible to set the data timing generator display off (from the Control Panel settings) and to display the screen image with external display. In this condition, images can be displayed at a higher resolution. If the external display is disconnected from the connector, images are displayed on the data timing generator screen at a resolution of 800 by 600 pixels, regardless of the resolution settings of the external display.
LAN	LAN is a port used to connect the data timing generator to a network. Connect a 10Base-T or 100BASE-T connector here. In the Master-Slave operation, the Master mainframe controls the Slave machine by way of network.

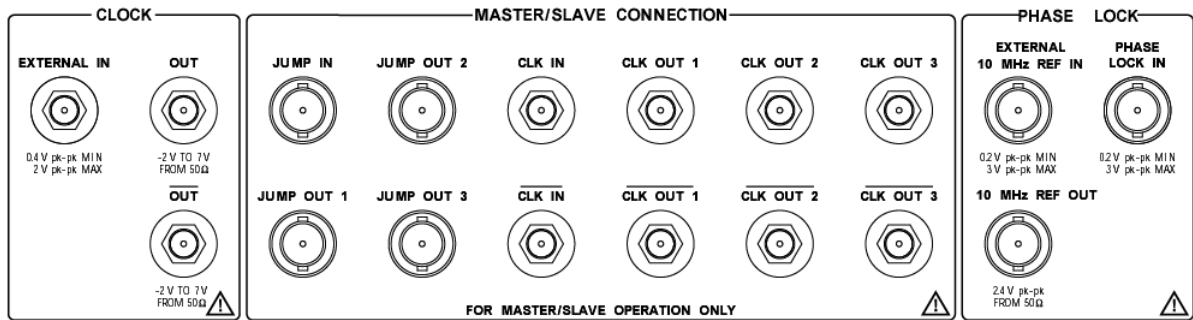

Figure 2-7: Rear panel connectors (DTG5078) (2)



CAUTION. To prevent damage to your data timing generator, do not apply a voltage outside the specified input voltage range.

Do not apply a voltage to the output connector.

Table 2-4: Rear panel connectors (2)

Connector	Description
<p>CLOCK</p>	<p>The following external clock input/output signal connectors are equipped (provided on the front panel in DTG5334)</p> <p>EXTERNAL IN. Connect the external clock input signal.</p> <ul style="list-style-type: none"> Input Voltage Range: 0.4 V_{p-p} to 2 V_{p-p} into 50 Ω Input Frequency Range: DTG5078: 1 MHz to 750 MHz DTG5274: 1 MHz to 2.7 GHz <p>OUT, $\overline{\text{OUT}}$. Outputs the clock signal. Amplitude and Offset can be set in the Time Base window.</p> <ul style="list-style-type: none"> Output Voltage Range VOH: -1.00 V to 2.47 V into 50 Ω to GND Output Voltage Range VOL: -2.00 V to 2.44 V into 50 Ω to GND Output Voltage Amplitude: 0.03 V_{p-p} to 1.25 V_{p-p} Resolution: 10 mV Signal type: Complementary Connector: SMA <p>NOTE. A 50Ω SMA termination is provided with your data timing generator mainframe. When you use the instrument with single end, attach the termination to the unused connector.</p>

Table 2-4: Rear panel connectors (2) (cont.)







Connector	Description
<p>Master-Slave Connection:</p> <p>CLK IN, $\overline{\text{CLK IN}}$</p> 	<p>Clock, Jump and Timing signals used for Master-Slave operation.</p> <p>Clock signal input connector to receive the clock signal from the master-mainframe.</p> <ul style="list-style-type: none"> ■ Voltage level: ECL ■ Connector: SMA
<p>CLK OUT1, CLK OUT2, CLK OUT3,</p> <p>$\overline{\text{CLK OUT1}}$, $\overline{\text{CLK OUT2}}$, $\overline{\text{CLK OUT3}}$</p> 	<p>Outputs the clock signals from the master-mainframe to control the clock of slave-mainframe.</p> <p>Connect the CLK OUT1 to CLK IN of master-mainframe. CLK OUT3 and $\overline{\text{CLK OUT3}}$ are equipped only in DTG5078.</p> <ul style="list-style-type: none"> ■ Connector: SMA
<p>JUMP IN</p> 	<p>Signal input connector to control the sequence waveform outputs in Master-Slave operation. Connect the master-mainframe JUMP OUTx signal to the slave-mainframe JUMP IN.</p> <ul style="list-style-type: none"> ■ Connector: BNC
<p>JUMP OUT1, JUMP OUT2, JUMP OUT3</p> 	<p>Signal output connectors to control the sequence waveform outputs in Master-Slave operation. This signal is used to control sequence waveform jumps of slave-mainframe. Connect the JUMP OUT1 to JUMP IN of master-mainframe. JUMP OUT3 is equipped only in DTG5078.</p> <ul style="list-style-type: none"> ■ Connector: BNC

Table 2-4: Rear panel connectors (2) (cont.)

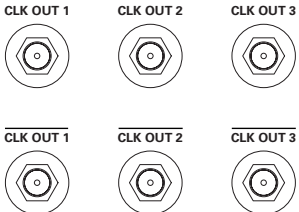
Connector	Description
<p>PHASE LOCK:</p> <p>PHASE LOCK IN,</p> 	<p>External PLL input/output signal connectors.</p> <p>External PLL input signal connector.</p> <ul style="list-style-type: none"> ■ Input Voltage Range: 0.2 V_{p-p} to 3.0 V_{p-p} ■ Input Frequency Range: 1 MHz to 200 MHz ■ Impedance: 50 Ω, AC coupled ■ Connector: BNC
<p>EXTERNAL 10 MHz REF IN</p> 	<p>External 10 MHz reference clock input signal connector.</p> <ul style="list-style-type: none"> ■ Input Voltage Range: 0.2 V_{p-p} to 3.0 V_{p-p} ■ Input Frequency Range: 10 MHz ± 0.1 MHz ■ Impedance: 50 Ω, AC coupled ■ Connector: BNC
<p>10 MHz REF OUT</p> 	<p>Outputs 10 MHz reference clock signal.</p> <ul style="list-style-type: none"> ■ Output Voltage Amplitude: <ul style="list-style-type: none"> 1.2 V_{p-p} into 50 Ω to GND 2.4 V_{p-p} into 1 MΩ to GND ■ Impedance: 50 Ω, AC coupled ■ Connector: BNC

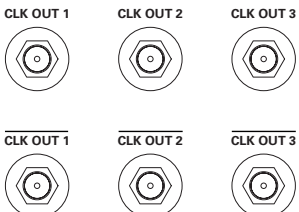
Display Area and Application Windows

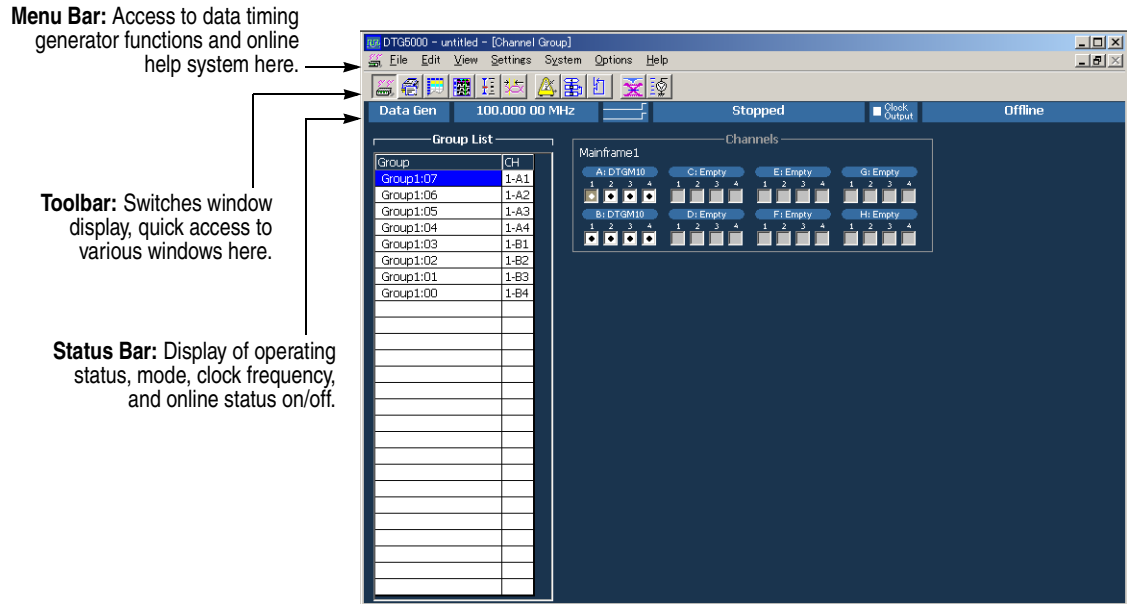
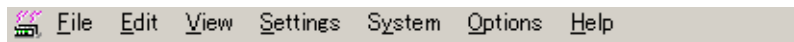

Figure 2-8: Screen elements just after the power on

Menu Bar You can access each of the menu bar items by using the **MENU** button and the Up, Down, Left and/or Right arrow keys.



DTG icons (control box menus). These menus control the data timing generator window operations.

Table 2-5: Control box menus

Items	Description
Resize	Restores the window to the initial display size.
Move	Moves the window. You can use the Up, Down, Left and/or Right arrow key to move the window in the direction. Press the Enter key for completion.
Size	Resizes the window. First, press the Up, Down, Left or Right arrow key to enable one of the window sides. Pressing another pair of arrow keys enables the window corner. Press the Enter key for completion.
Minimize	Minimizes the window.
Maximize	Maximizes the window.
Close (Alt + F4)	Closes current window.

File Menu. The File menu controls the data timing generator file operations.

Table 2-6: File menus

Items	Description
Default Setup	Restores the data timing generator settings to the defaults.
Open Setup...	Opens the saved settings file.
Save Setup	Saves current settings, overwriting the old ones.
Save Setup As...	Saves current settings in a new file under a name you specify.
Import...	Imports a file created with another application. (Data-Listing and Data-Waveform window)
Exit	Exits the DTG5000 software.
Shutdown	Exits all the applications including the DTG5000 software and shuts down Windows, then powers off the DTG5000 series mainframe. This menu cannot be selected in the offline mode.

Edit Menu. The Edit menu shows various pull-down menus depending on the active window or the items specified by cursor. Refer to each window description.

View Menu. The View menu controls the data timing generator display.

Table 2-7: View menus

Items	Description
View by Channel	Displays data for channel by channel. (Data-Listing, Data-Waveform, Level, and Timing window)
View by Group	Displays data for group by group. (Data-Listing, Data-Waveform, Level, and Timing window)
Zoom In	Doubles the size of the view horizontally, with the cursor position as the base. (Data-Waveform window)
Zoom Out	Halves the size of the view horizontally, with the cursor position as the base. (Data-Waveform window)
View with Timing	When the data timing generator displays the data pattern, the Timing window setup information such as Format, Delay, Pulse Width and Polarity are included. (Data-Waveform window)
Move Up	Moves current-selected line upwards one line. (Timing and Level window) Moves current group position upwards one line. (Data-Waveform window)
Move Down	Moves current-selected line down one line. (Timing and Level window) Moves current group position down one line. (Data-Waveform window)
Move Left	Moves current group position left by one. (Data-Listing window)
Move Right	Moves current group position right by one. (Data-Listing window)

Table 2-7: View menus (cont.)

Items	Description
Reset Order	Arranges the channels within the current group according to their numbers. (Timing and Level window) This command has no influence on viewing in the Data-Listing or Data-Waveform window.
Properties...	Specifies the display format such as Radix, Signs, Magnification display. (Data-Listing and Data-Waveform window) Specifies how data is listed when viewed by group.
Toolbar	Hides or displays the toolbar.

Settings Menu. The Settings menu allows the selection of setup windows.

Table 2-8: Settings menus

Items	Description
Channel Group	Displays the Channel Group window which creates/edits groups and assigns logic and physical channels.
Blocks	Displays the Blocks window which creates and edits blocks.
Data-Listing	Displays the Data-Listing window which creates and edits patterns.
Data-Waveform	Displays the Data-Waveform window which creates and edits patterns.
Level	Displays the Level window which sets the output level.
Timing	Displays the Timing window which sets the clock frequency, delay, long delay on/off.
Module Config	Displays the Module Config window which sets the Jitter Range of the output module DTGM32.
Time Base	Displays the Time Base window which specifies the clock source, trigger source, and event signals.
Sequence	Displays the Sequence window which creates sequence. It also sets the jump mode and jump timing.
Subsequence	Displays the Subsequence window which creates subsequence.
Jitter Generation	Displays the Jitter Generation window which sets the jitter generation parameters.
DC Output	Displays the DC Output window which sets the DC Output parameter.

System Menu. The System menu contains the items related to the data timing generator system.

Table 2-9: System menus

Item	Description
Run	Starts the signal output. This is the same as pushing the RUN button on the front panel.
Stop	Stops the signal output. This is the same as pushing the RUN button on the front panel during the signal output is being performed.
Data Generator	Switches to Data Generator mode. This has the same effect as pushing the front panel PULSE GEN button or clicking Data Gen/ Pulse Gen button on status bar.
Pulse Generator	Switches to Pulse Generator mode. This has the same effect as pushing the front panel PULSE GEN button or clicking Data Gen/ Pulse Gen button of status bar.
Remote Control...	Makes the settings for remote control through GPIB.
Diagnostics...	Executes the internal hardware check.
LCD Panel Check...	Executes the LCD operation check.
Front Panel Key Check...	Verifies if the front panel controls are operational. Pressing a key or knob on the front panel to display its name and change the color of the key or knob on the screen. Pressing ENTER key twice to exit the front panel key check.
Skew Calibration...	Executes the skew calibration.
Level Calibration...	Executes the level calibration.
DTGM31 Dj Adjustment...	Executes the DTGM31 deterministic jitter adjustment.
Service Password...	Displays the password input dialog box. This menu is provided for service engineer.

Options Menu. The Options menu contains the Preference item that is used for the instrument setup.

Table 2-10: Options menu

Items	Description
Preference...	Startup: You can select a startup state for either default settings or the most recent settings you used. LCD Brightness: Adjusts the brightness of the display screen of the data timing generator.

Help Menu. The Help menu contains help topics and password input box.

Table 2-11: Help menus

Items	Description
Help Topics...	Opens the DTG5000 series online help screen.
Help on Window...	Opens the help screen for currently displayed window.
Specifications...	Displays the DTG5000 series specifications.
Contacting Tektronix...	Displays the contact information for product support.
About DTG...	Displays the instrument software version and copyright information.

Toolbar. The toolbar contains the shortcut buttons for the data timing generator. Accessing the toolbar requires a mouse. Two types of toolbars are provided; the common toolbar to all windows and a specific toolbar for several windows. See Figure 2-9.

To hide or display the toolbar on the screen, select **Toolbar** from the **View** menu.

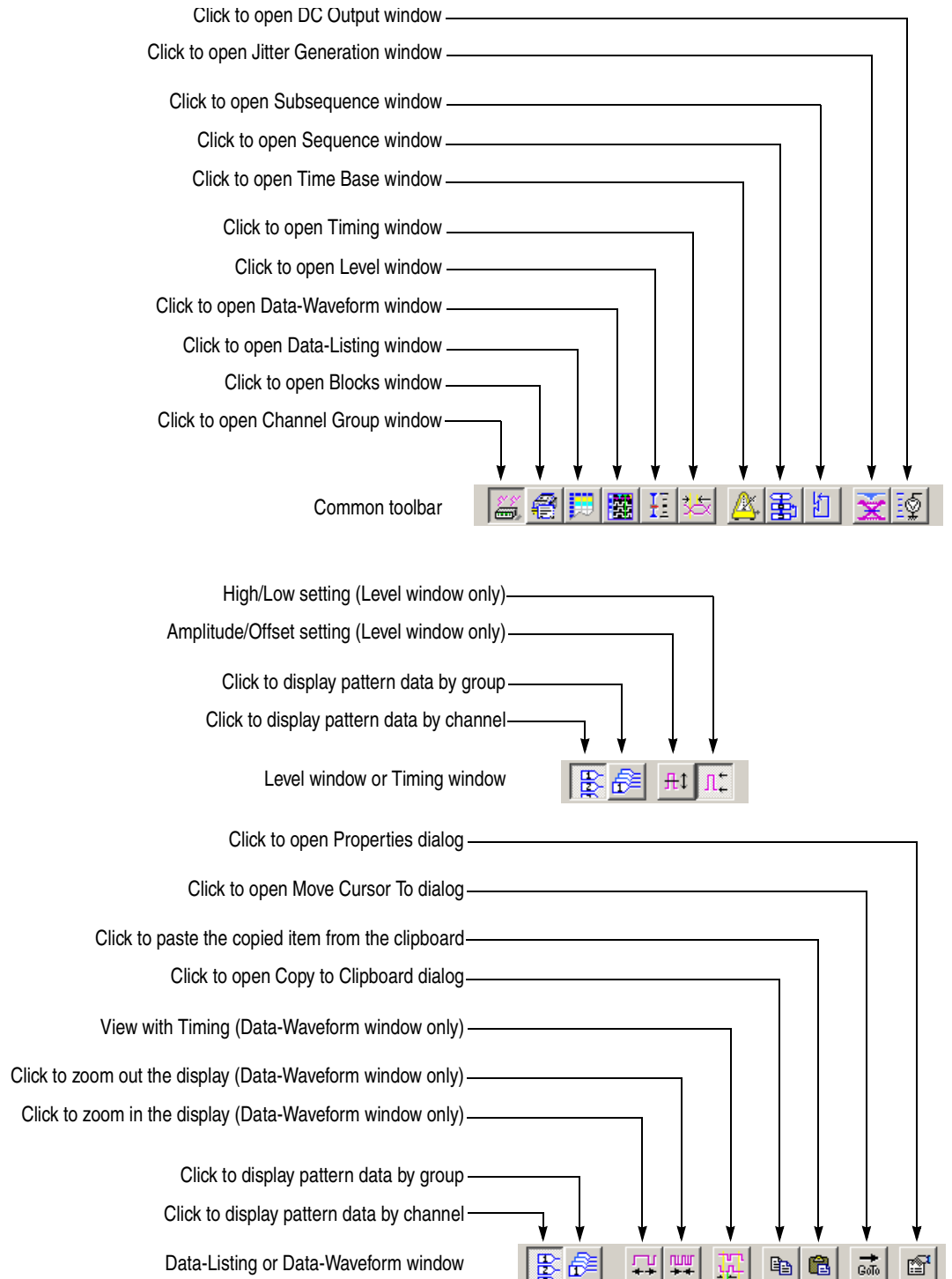

Figure 2-9: Toolbar

Status Bar. The status bar provides useful information about the state of the data timing generator operation or setup.

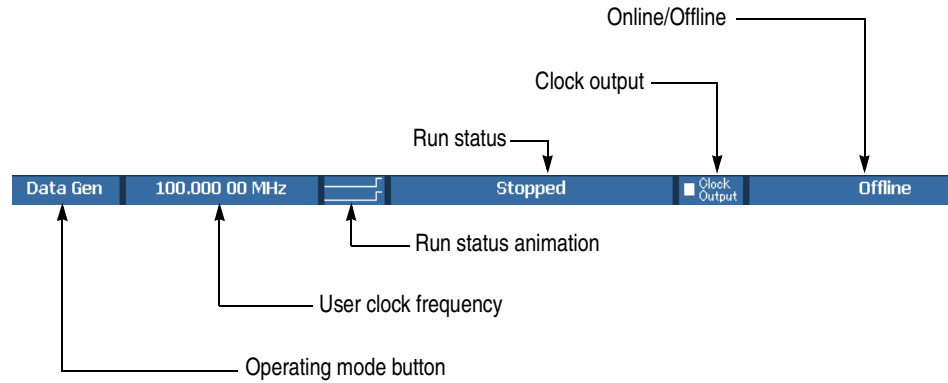

Figure 2-10: Status bar

Table 2-12: Status Bar

Items	Description
Operating mode button	Displays the operating mode (Data Generator mode or Pulse Generator mode). Click to toggle DG and PG modes.
User Clock frequency	Displays the user clock frequency and period set by Timing window. User clock frequency = H/W clock frequency / Vector rate
Run status animation	Displays the sequencer status with animated screen.
Run status	Displays the sequencer status.
Clock Output	Displays the on/off of clock output.
Online/Offline	Displays the DTG5000 software execution mode. Appears only in the offline mode.

Channel Group Window

The Channel Group window enables you to group the logical channels and associate the logical channels with physical channels. The physical channels represent the hardware channels which are actually installed in the data timing generator. See Figure 2-11.

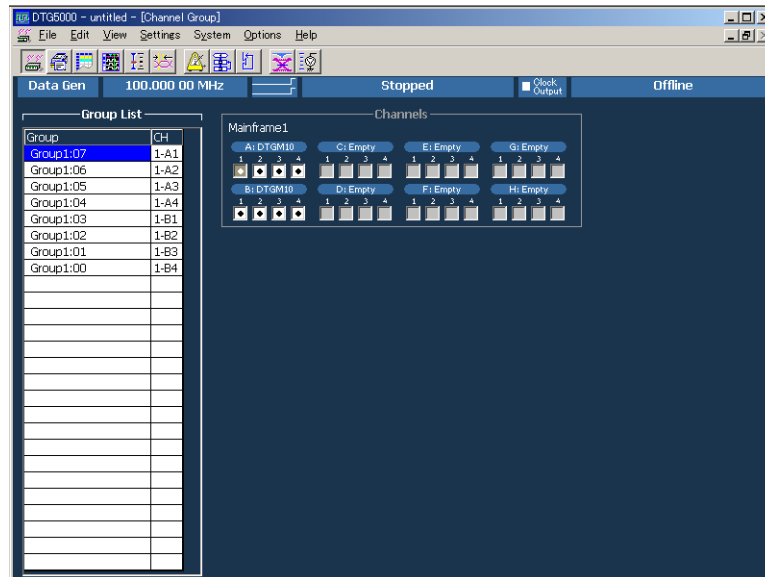

Figure 2-11: Channel Group window

- **Group List.** This list shows the logical channels comprising each of the groups and the physical channels associated with the logical channels. By default, the list shows the installed hardware channels (online mode) or logical channels set by the DTG5000 Configuration Utility (offline mode). The channels are grouped by eight channels.
- **Channels.** This list shows the actual installed channels (online mode) or physical channels set by the DTG5000 Configuration Utility (offline mode).

Edit menu. This menu contains group editing and channel assignment commands.

Table 2-13: Edit menus for Channel Group window

Items	Description
New Group...	Creates a new group.
Delete Group	Deletes the group you selected.
Delete All Group	Deletes all the groups.
Rename/ Resize Group...	Renames the group you selected. Changes the number of channels included in the group.

Table 2-13: Edit menus for Channel Group window (cont.)

Items	Description
Auto Assign	Assigns physical channels installed in the data timing generator to the logical channels in order.
De-assign All	Clears all the logical and physical channels assignments.
De-assign	Clears the physical channels assigned to the logical channels you selected.
Preset	
8 Channels per Group	Defines the number of channels per group as 8.
1 Channel per Group	Defines the number of channels per group as 1.
All Channels in One Group	Collects all the channels in a single group.

Blocks Window

The basic data pattern is called “block” in the Data Generator mode. In the Blocks window, you can create a new block, rename it, and resize or delete the block.

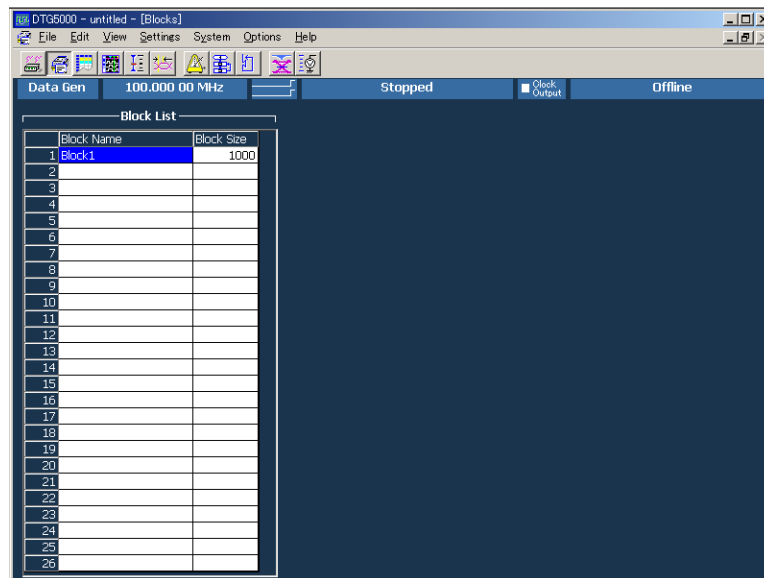

Figure 2-12: Blocks window

Table 2-14 shows the setup items in the Blocks window.

Table 2-14: Setup items for Blocks window

Items	Description
Block Name	Specifies the block name. Accepts up to 32 characters and 8,000 blocks.
Block Size	Specifies the block size. Up to 64,000,000 (DTG5334) or up to 32,000,000 (DTG5274) or up to 8,000,000 (DTG5078).

Edit Menu. This menu contains commands that are used to delete blocks or move them to the edit windows.

Table 2-15: Edit menus for Blocks window

Items	Description
Edit	Sets Block Name or Block Size.
View Listing	Views the content of the selected block in the Data-Listing window, where you can edit its content.
View Waveform	Views the content of the selected block in the Data-Waveform window, where you can edit its content.
Delete	Deletes the block on the selected line.

Data-Listing Window

In this window, a list of blocks is displayed in tabular form that can be edited. The content edited in the Data-Listing window is the same as that of Data-Waveform window. The only difference is their display format. The Data-Listing window displays the data as tabular form, while the Data-Waveform window displays the data graphically. Because the data to be edited is identical, the edited data in either of the windows is automatically reflected in the other.

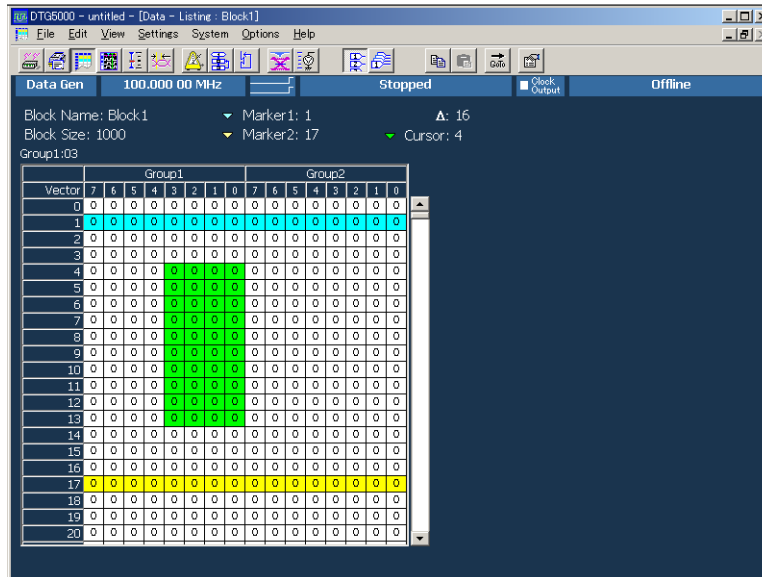

Figure 2-13: Data-Listing window

A table which indicates the blocks, a cursor, and a marker which specifies the edit range are displayed in the window.

The table is displayed by channel or by group. In the group mode, you can select one of various Radix display formats.

There are two methods to edit a pattern. Directly enter the numeric value to each cell or use the Edit menu.

Sometimes the editing requires specifying the edit range. You can specify all of the current channels and groups, the channels and groups between markers, or the area you specified with cursor.

Edit Menu. This menu contains commands that create or edit various data patterns, move the cursor or marker, switch between the channel and group views, and sort the channels and groups listed.

Table 2-16: Edit menus for Data-Listing window

Items	Description
Undo	Reverses the previous change to the data.
Move Cursor To...	Moves cursor.
Move Marker To...	Moves Marker 1 or Marker 2.
Copy...	Copies the data to the data timing generator clipboard.
Paste	Pastes the data copied in the data timing generator clipboard on the location starting from the active cursor cell.
Invert...	Inverts the data between 0 and 1 in the specified range.
Mirror...	Mirrors the data in the specified range in the vector or bitwise direction.
Shift/Rotate...	Moves the data in the specified range in the vector or bitwise direction. Shift fills the empty cells with 0s. Rotate fills them with the off-screen data.
Fill with One/Zero...	Fills the specified range with 0s or 1s.
Clock Pattern...	Fills the specified range with a clock pattern of 0s and 1s.
Predefined Pattern...	Fills the specified range with a Binary Counter, Johnson Counter, Graycode Counter, Walking Ones, Walking Zeros or Checker Board pattern.
User Defined Pattern	Fills the specified range with a pattern the user entered.
PRBS/PRWS...	Fills the specified range with a pseudo random pattern.
Select Block...	Select another block to be viewed or edited.
Copy to Clipboard...	Copies the data in the specified range as characters to the Windows clipboard.
Paste from Clipboard...	Pastes the data copied in the Windows clipboard as characters to the location starting from the active cursor cell. Also available for importing data from other applications.

Data-Waveform Window

In this window, the blocks are displayed graphically and they can be edited. The content edited in the Data-Waveform window is the same as that of Data-Listing window. The only difference is their display format. The Data-Listing window displays the data as tabular form, while the Data-Waveform window displays the data graphically. Because the data to be edited is identical, the edited data in either of the windows is automatically reflected in the other.

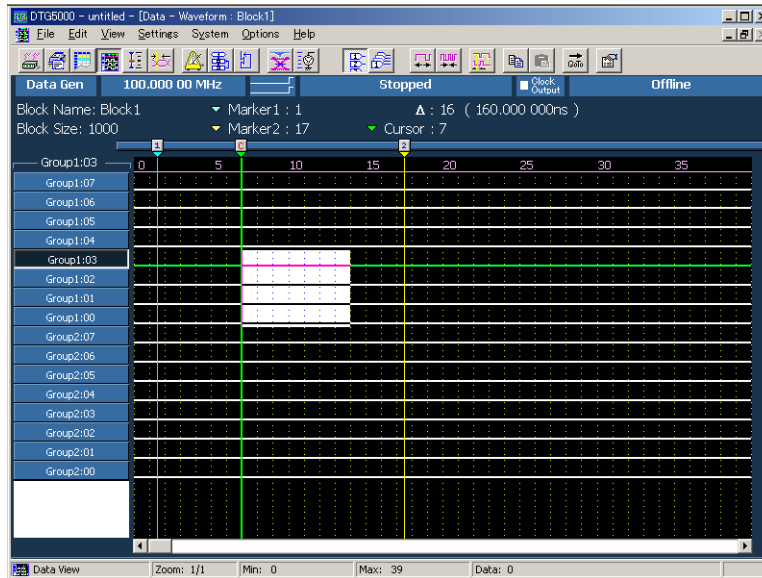

Figure 2-14: Data-Waveform window

Edit Menu. This menu contains the same commands as the Data-Listing window.

Table 2-17: Edit menus for Data-Waveform window

Items	Description
Undo	Reverses the previous change to the data.
Move Cursor To...	Moves cursor.
Move Marker To...	Moves Marker 1 or Marker 2.
Copy...	Copies the data to the data timing generator clipboard.
Paste	Pastes the data copied in the data timing generator clipboard on the location starting from the active cursor cell.
Invert...	Inverts the data between 0 and 1 in the specified range.
Mirror...	Mirrors the data in the specified range in the vector or bitwise direction.
Shift/Rotate...	Moves the data in the specified range in the vector or bitwise direction. Shift fills the empty cells with 0s. Rotate fills them with the off-screen data.
Fill with One/Zero...	Fills the specified range with 0s or 1s.

Table 2-17: Edit menus for Data-Waveform window (cont.)

Items	Description
Clock Pattern...	Fills the specified range with a clock pattern of 0s and 1s.
Predefined Pattern...	Fills the specified range with a Binary Counter, Johnson Counter, Graycode Counter, Walking Ones, Walking Zeros or Checker Board pattern.
User Defined Pattern	Fills the specified range with a pattern the user entered.
PRBS/PRWS...	Fills the specified range with a pseudo random pattern.
Zoom In	Doubles the size of the view horizontally, with the cursor position as the base.
Zoom Out	Halves the size of the view horizontally, with the cursor position as the base.
Move Up	Moves the current group position up one line. Available only when the table is viewed by group.
Move Down	Moves the current group position down one line. Available only when the table is viewed by group.
Reset Order	Arranges the channels within the current group according to their numbers. Available only when the table is viewed by channel. Has no influence on viewing in the Waveform window.
Properties...	Specifies how data is listed when viewed by group (Magnitude).
Select Block...	Select another block to be viewed or edited.
Copy to Clipboard...	Copies the data in the specified range as text to the Windows clipboard.
Paste from Clipboard...	Pastes the data copied in the Windows clipboard as text to the location starting from the active cursor cell. Also available for importing data from another application.

Level Window In this window, you can set the High/Low levels and the termination voltage or impedance for logic channel. It also allows you to turn the output to on or off. The level of output signal can be specified by combining the High/Low levels or Amplitude/Offset values.

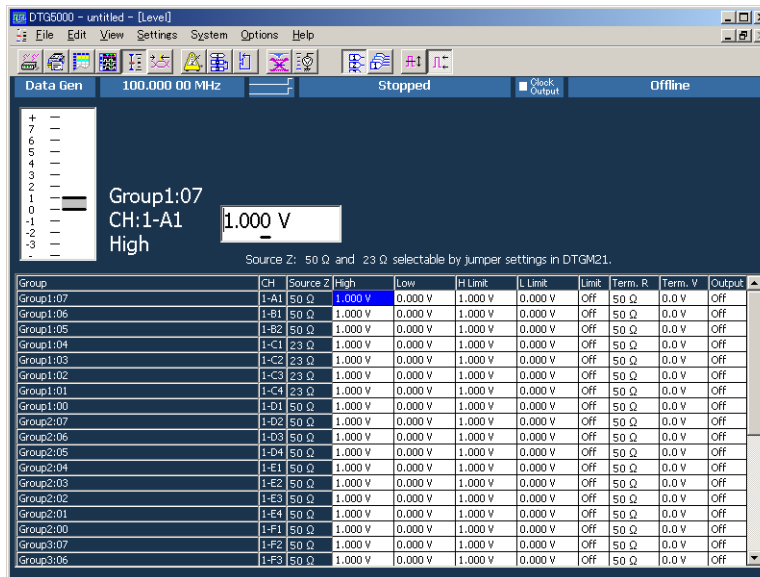

Figure 2-15: Level window

The Level window allows you to setup the items for each channel. See Table 2-18.

Table 2-18: Setup items for Level window

Items	Description
Source Z	Displays the source impedance of physical channel. (Display only)
High	Sets the High level value.
Low	Sets the Low level value.
H Limit	Sets the High level limit value.
L Limit	Sets the Low level limit value.
Limit	Turns on or off the High/Low limit feature.
Term. R	Sets the termination impedance of the destination of the output signal.
Term. V	Sets the termination voltage of the destination of the output signal.
Output	Turns the output to on or off.

Edit Menu. The Edit menu of the Level window allows you to set the items below. You can turn on or off Limit and Output, or you can specify Open to Termination Impedance (Term.R), depending on the selection. The Table 2-19 lists the common setting items regardless of the selection:

Table 2-19: Edit menus for Level window

Items	Description
Predefined Level...	Provides the following levels: TTL (into open), TTL (into 50 Ω to GND), CMOS 5 V (into open), CMOS 3.3 V (into open), ECL (into 50 Ω to -2 V), PECL (into 50 Ω to 3 V), PECL (into 50 Ω to 5 V), LVPECL (into 50 Ω to 1.3 V), LVPECL (into 50 Ω to 3.3 V), LVDS (into 100 Ω differential), TMDS (into 50 Ω to 3.3 V), RSL (into 28 Ω to 1.8 V), CML (into 50 Ω to GND)
High/Low	Specifies High and Low for the level setting.
Amplitude/Offset	Specifies Amplitude and Offset for the level setting.
Apply to Channels in the Same group	Applies the currently selected settings to all channels within the group.
Apply to All Channels	Applies the currently selected settings to all channels.

Timing Window

In this window you can set the pattern format and time base parameters such as the frequency, delay, pulse width and slew rate. Some of the settings parameters are different in Data Generator mode and Pulse Generator mode.

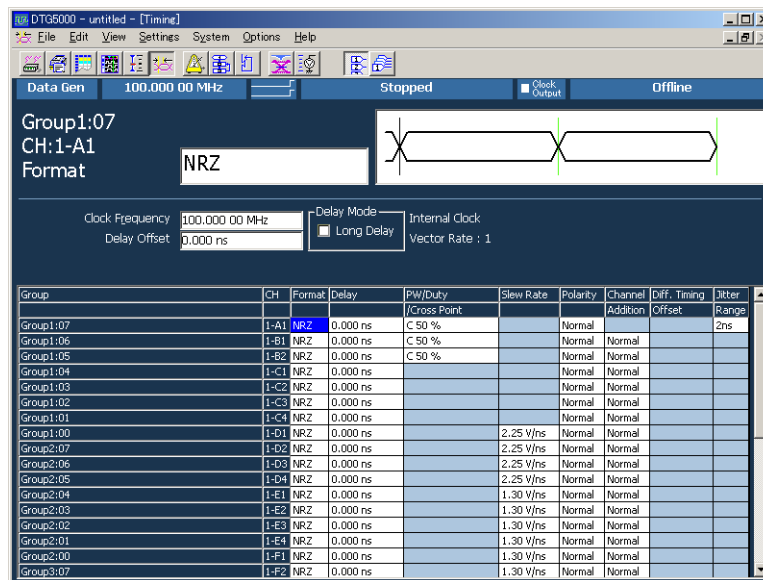

Figure 2-16: Timing window (Data Generator mode)

Table 2-20: Setup items for Timing window

Items	Description
Clock Frequency	Sets the clock frequency of the data timing generator system. Either Frequency or Period is available for this setting.
Delay Offset	Sets the offset amount of the delay time.
Delay Mode	Selects Long Delay on/off.
Clock Range	Sets the clock range when Long Delay is on.
Vector Rate	Vector rate (viewed only)
Internal Clock, PLL Input, External Reference Input, External Clock Input	Shows current clock source or the frequency of the external clock signal.
Group	Shows the group name when View by Group is selected. Alternatively shows both the group name and channel number when View by Channel is selected.
CH	Shows the physical channel assigned in the Channel Group window.
Format	Selects NRZ, RZ or R1 for the pattern format.
Delay	Sets the lead delay (time or percentage).

Table 2-20: Setup items for Timing window (cont.)

Items	Description
PW/Duty/Cross Point	Sets the pulse width or the duty when the format is set to RZ or R1. Any of Duty(%), Pulse Width(s) or Trail Delay(s) is available for this setting. If the format is set to NRZ and a logical channel assigned to a DTGM30 or DTGM31 or DTGM32 channel, you can change the cross point position by shifting the rising or falling edge.
Slew Rate	Sets the slew rate (V/ns). Available for any channel assigned to a DTGM10 or a DTGM20 channel.
Polarity	Selects Normal or Invert for the polarity of the pattern.
Channel Addition	Sets the channel addition. Selects from Normal, XOR, or AND. If the odd CH is assigned to physical channel, Normal and XOR can be selected. If the even CH is assigned to physical channel, Normal and AND can be selected.
Diff. Timing Offset	Shifts timing for only inverted side of differential output. Sets differential timing offset on/off and timing volume.
Jitter Range	Sets the jitter range of jitter by the external signal. Available for any channel assigned to a DTGM32 channel.

Edit Menu. The Edit menu of the Timing window contains the commands common to the whole table and the commands available for the currently selected item.

Table 2-21: Edit menus for Timing window

Items	Description
Apply to Channels in the Same Group	Sets the currently selected settings for all channels within the group.
Apply to All Channels	Sets the currently selected settings for all channels.
Differential Timing Offset	Turns on or off the Differential Timing Offset of the currently selected channels or group.
NRZ RZ R1	Selects the data format (when Format is selected).
Lead Delay Phase(%)	Specifies the rising position of a pulse (when Delay is selected).
Duty (%) Pulse Width (s) Trail Delay (s)	Specifies which is used to set the falling position of a pulse (when PW/Duty is selected).
Normal Invert	Sets the polarity (when Polarity is selected).
Normal AND XOR	Sets the channel addition mode (when Channel Addition is selected).
1ns 2ns	Sets the jitter range of the DTGM32 output module (when Jitter Range is selected).

Time Base Window

The Time Base window allows you to specify the clock source, trigger source, or event signal.

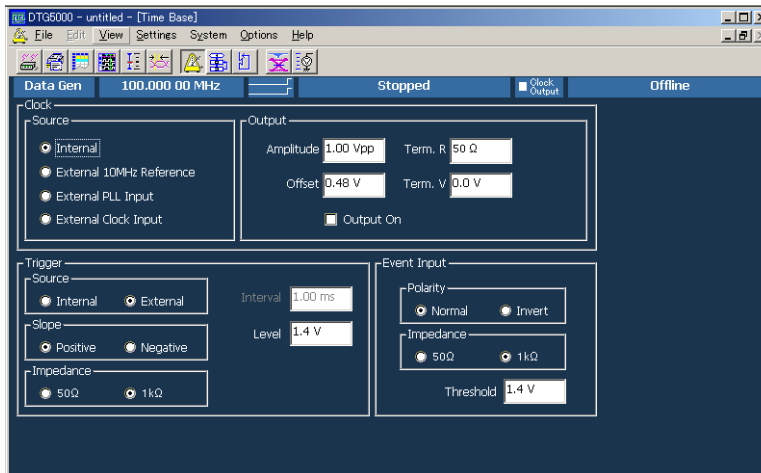

Figure 2-17: Time Base window

Table 2-22 shows setup items in the Time Base window.

Table 2-22: Setup items for Time Base window

Items	Description
Clock Source	Selects clock source.
Internal	Use internal clock.
External 10MHz Reference	Use 10 MHz reference clock connected to 10 MHz Reference In.
External PLL Input:	Use external PLL signal connected to Phase Lock In.
External Clock Input:	Use signal connected to External Clock In as an external clock.
Clock Output	Sets the clock output parameters.
Amplitude	Sets clock output signal amplitude.
Offset	Sets offset.
Term.R	Sets termination impedance.
Term.V	Sets termination voltage.
Output On	Specifies on/off of clock output.
Trigger	Sets the trigger parameters.
Source	Selects trigger source from internal/external. Specifying Internal allows to set the Interval. Specifying External allows to set the Level, Slope and Impedance.
Slope	Specifies the trigger point (rising edge or falling edge of external trigger signal). Selects either Positive or Negative.
Impedance	Specifies external trigger impedance. (50 Ω or 1 kΩ)

Table 2-22: Setup items for Time Base window (cont.)

Items	Description
Interval	Specifies internal trigger interval.
Level	Specifies external trigger level.
Event Input	Sets the event input signal parameters.
Polarity	Specifies rising or falling edge. (Normal or Invert)
Impedance	Specifies event signal input impedance. (50 Ω or 1 k Ω)
Threshold	Specifies event signal input threshold level.

There is no Edit menu on this window.

Sequence Window

A sequence is a data structure of one or more combined blocks, where the data timing generator can output more complex pattern. The Sequence window allows you to define the blocks, the output sequence, the jumping method, and other sequence conditions.

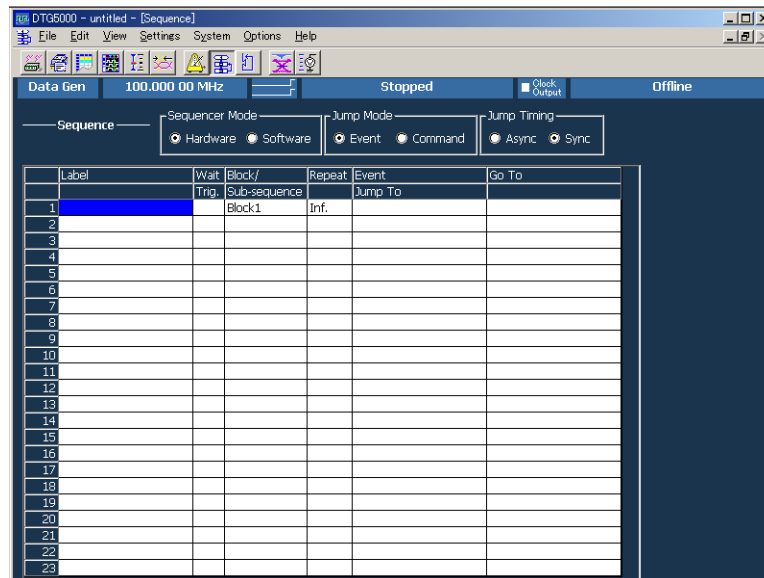

Figure 2-18: Sequence window

Table 2-23 shows setup items in the Sequence window.

Table 2-23: Setup items for Sequence window

Items	Description
Label	Sets the line name. Accepts up to 16 characters for each label name and defines up to 8,000 lines. Labels defined may be used as destinations of Event Jump To and/or Go To.
Wait. Trig.	Specifies whether the system waits for triggering before outputting the line. Selects On or Off (blank).
Block/Subsequence	Specifies the name of the block or subsequence to be output on the line. Accepts up to 32 characters for each name.
Repeat	Specifies the number of repetitions of the block or subsequence. Accepts an integer from 1 to 65,536 or Infinite.
Event Jump To	Specifies the label of the line to which control jumps when an event occurs while the contents of the current line are being output. If the cell is left blank, control will not jump.
Go To	Specifies the label of the line to which control jumps unconditionally after the contents of the current line are output. If the cell is left blank, control goes to the next line.
Sequencer Mode	Selects hardware sequence or software sequence.

Table 2-23: Setup items for Sequence window (cont.)

Items	Description
Jump Mode	Selects event jump (external event signal, front panel button, remote commands) or command jump which is controlled by remote commands.
Jump Timing	Selects ASync which jumps immediately or Sync which does not jump (waits for the completion of current blocks outputs).

Edit Menu. The Edit menu of the Sequence window contains commands not only for the line operations, but also for the currently selected item.

Table 2-24: Edit menus for Sequence window

Items	Description
Edit	Edits Label, block name, subsequence name, or jump destination.
Wait Trigger	Selects On or Off of Wait Trigger (when Wait Trig. is selected).
Infinite	Selects Infinite for Repeat count (when Repeat is selected).
Delete Line	Deletes the line that active cursor is placed.
Insert Line Before	Inserts a blank line immediately above the line that active cursor is placed.
Insert Line After	Inserts a blank line immediately under the line that active cursor is placed.
View Listing	Changes the current window display to Data-Listing window, where shows selected blocks. This menu selection is available when the block name is selected.
View Waveform	Changes the current window display to Data-Waveform window, where shows selected blocks. This menu selection is available when the block name is selected.
View Subsequence Definition	Changes the current window display to Subsequence window, where shows selected subsequences. This menu selection is available when the subsequence is selected.

Subsequence Window

A subsequence is a suite of the blocks used in the main sequence. In this window you can define the subsequences that are used in the sequence.

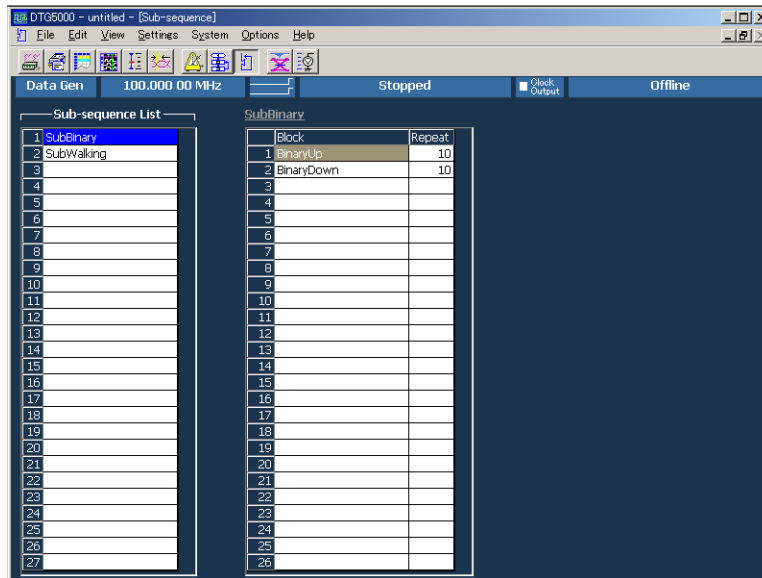

Figure 2-19: Subsequence window

Subsequence List (left) contains the names of the currently defined subsequences. You can define up to 50 subsequences.

The right table lists the contents of the subsequence selected. For each subsequence, you can define up to 256 lines.

Table 2-25: Setup items for Subsequence window

Items	Description
Block	Specifies the name of the block to be output on the line. Accepts up to 32 characters for each block name.
Repeat	Specifies the number of repetitions of the block. Accepts an integer from 1 to 65,536, but does not accept Infinite.

Edit Menu. The Edit menu of the Subsequence window contains commands not only for the line operations, but also for the currently selected item.

Table 2-26: Edit menus for Subsequence window

Items	Description
Delete Line	Deletes the line that active cursor is placed.
Insert Line Before	Inserts a blank line immediately above the line that active cursor is placed.
Insert Line After	Inserts a blank line immediately under the line that active cursor is placed.
View Listing	Switches the window display to the Data-Listing window, where shows selected blocks. This menu selection is available when the block name is selected.
View Waveform	Switches the window display to the Data-Waveform window, where shows selected blocks. This menu selection is available when the block name is selected.

Jitter Generation Window

In this window you can set the parameters required for jitter generation. The jitter generation is available only for Slot A, CH1.

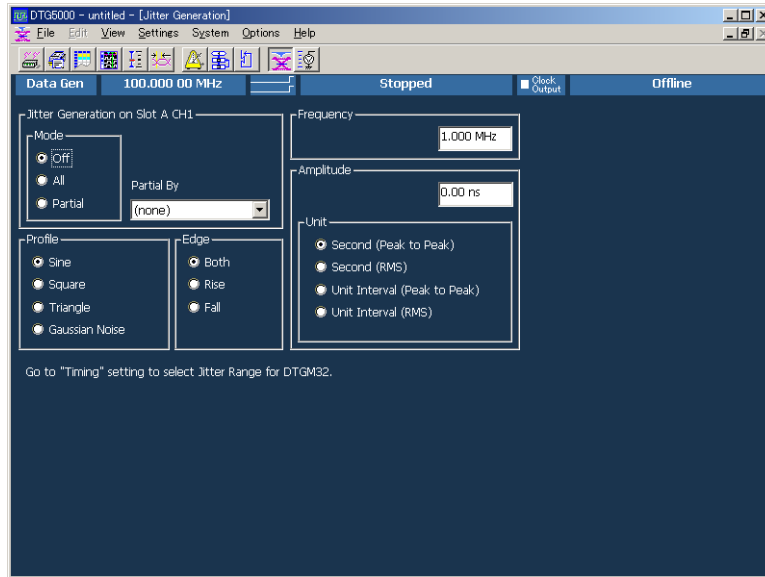

Figure 2-20: Jitter Generation window

Table 2-27: Setup items for Jitter Generation window

Items	Description
Jitter Generation on Slot A CH1	<p>Off: Turns off jitter generation.</p> <p>All: Applies a jitter to the whole pattern of Slot A Ch1.</p> <p>Partial: Partially applies a jitter to the pattern of Slot A Ch1. The partial jitter is generated at the point logical channel set to 1. You can select the logical channel using Partial By field.</p>
Profile	Selects jitter profile.
Edge	Specifies the edge to apply a jitter.
Frequency	Sets the repetitive frequency of the profile.
Amplitude	Set the profile amplitude and jitter width. For the unit, you may select either s (seconds) or UI (Unit Interval, 1 clock period of data timing generator). Specifies peak-to-peak or RMS values.

There is no Edit menu on this window.

DC Output Window

In this window you can set the parameters of the DC output located at the front right of the data timing generator. Eight channel DC outputs are equipped with a mainframe. While the system configuration is in Master-Slave mode, the master machine can control the DC Outputs of all the slave machines.

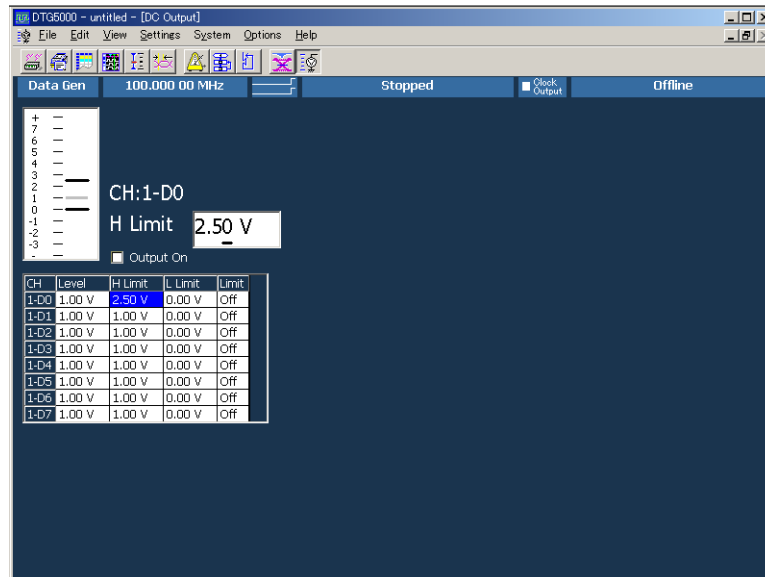

Figure 2-21: DC Output window

The DC Output window allows you to set the following for each channel. See Table 2-28.

Table 2-28: Setup items for DC Output window

Items	Description
Level	Sets the DC level value.
H Limit	Sets the maximum value of DC level setting range.
L Limit	Sets the minimum value of DC level setting range.
Limit	Turns on or off the High/Low limit function.
Output On	Powers the output on or off.

Edit Menu. Provides the predefined levels.

Table 2-29: Edit menus for DC Output window

Items		Description
TTL.	High	Sets 2.50 V.
	Low	Sets 0.00 V.
CMOS 5 V	High	Sets 5.00 V.
	Low	Sets 0.00 V.
CMOS 3.3 V	High	Sets 3.30 V.
	Low	Sets 0.00 V.
ECL	High	Sets -0.90 V.
	Low	Sets - 1.70 V.
PECL	High	Sets 4.10 V.
	Low	Sets 3.30 V.
LVPECL	High	Sets 4.10 V.
	Low	Sets 1.60 V.
LVDS	High	Sets 1.40 V.
	Low	Sets 1.00 V.
TMDS	High	Sets 3.30 V.
	Low	Sets 2.80 V.
RSL	High	Sets 1.80 V.
	Low	Sets 1.00 V.
CML	High	Sets 0.00 V.
	Low	Sets - 0.41 V.

Using the Menu System

This section describes the basic operation of the data timing generator using the front panel keys, buttons and knob.

Menu System Pushing the front panel **MENU** button displays the last menu you selected on the menu bar.

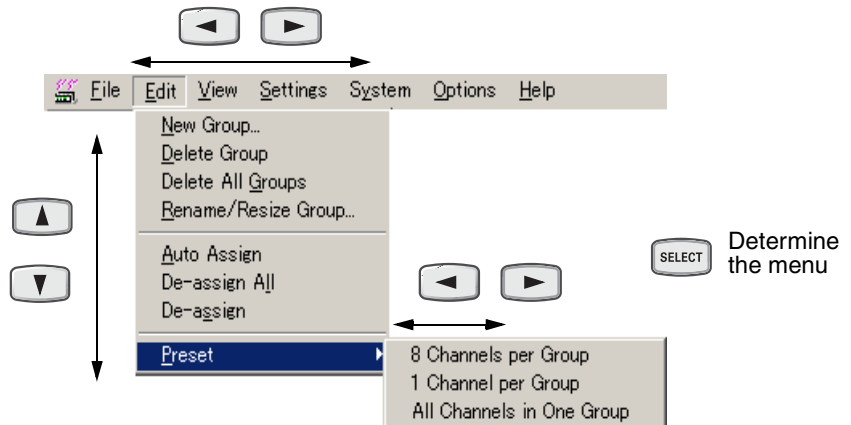







Figure 2-22: Menu selection

Table 2-30: Menu selection

Key	Description
	Displays the last menu you selected on the menu bar. Cancel the menu display when a menu is displayed.
	Navigates through a pull-down menu list. You can also use the knob instead of the arrow keys to navigate through a menu list.
	Shows a submenu (). Navigate s through the menu bar pressing on a menu item not having any submenu.
	The menu is determined.
	To cancel the menu display, press the ESC key twice. When you press it only once, the menu bar is still active although the display disappears. In this state, you can navigate through the menu bar by pressing the , keys.

Table 2-30: Menu selection (cont.)

Key	Description
	Activates the menu bar. Then, you can make a menu selection using the   ,   keys.

Pop-up Menu Items. In the individual data timing generator windows, selecting the setup item and pushing the front panel **SELECT** button displays the pop-up menu item(s) corresponding to the selected item. Refer to Figure 2-24 on page 2-44 for a pop-up menu example.

Using a Window

The data timing generator windows contain various items of information. Input of numeric values such as the output level and clock rate, selection of the trigger source and other settings, creation of the pattern data, and other operations can be performed.

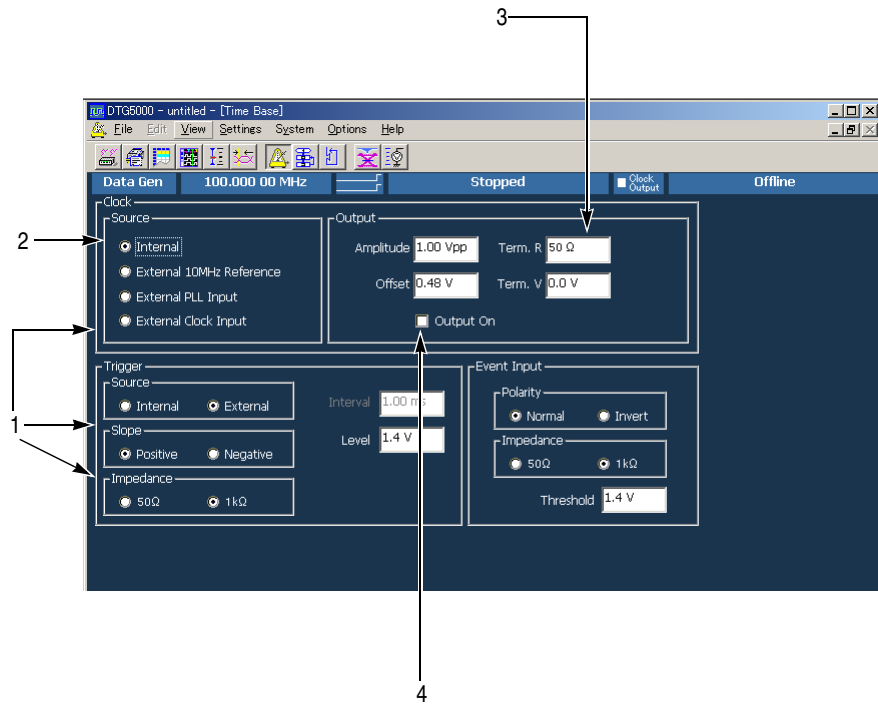





Figure 2-23: Window operation 1: Time Base window

Table 2-31: Time Base Window operation

Key operation	Description
	<p>1. To navigate through the Clock Source, Output Amplitude, and other similar items, use the TAB key. You can navigate through these in the reverse direction by pressing the SHIFT and TAB keys simultaneously. Displays the last menu you selected on the menu bar.</p>
	<p>2. To select the parameter with radio buttons such as Clock Source or Trigger Source, use the Up, Down, Left and/or Right arrow key.</p>
	<p>3. Any numeric input box has a unit attribute according to the setting. The unit attribute s is for the time, V for the voltage, Ω for the resistance, or nothing for the count or size. To enter a numeric value, use either numeric keys or the knob. For details, see <i>Numeric Input</i> on page 2-50.</p>
	<p>4. To place the check sign into a check box such as Output On, use the SPACE key.</p>

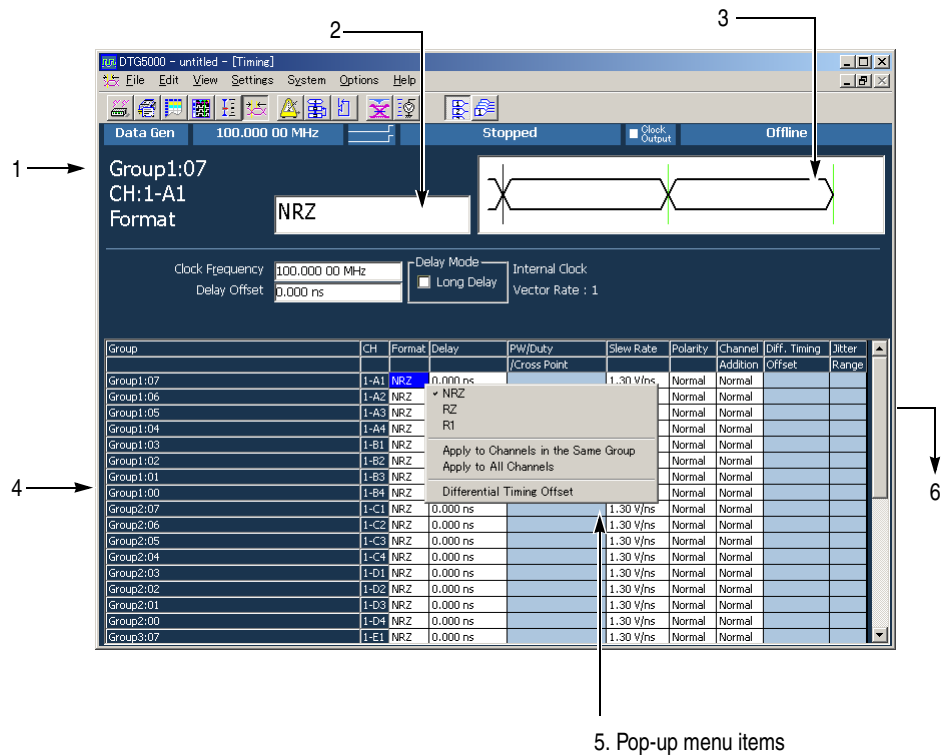

Figure 2-24: Window operation 2: Timing window





A table appears in the Timing, Level and Data-Listing windows. Figure 2-24 shows Timing window.

1. The information area shows the selected parameter information.
2. In the parameter box you can enter numeric values or characters.
3. A Pattern Display Box that contains a pattern corresponding to the Format or Delay appears.
4. The parameter area at the lower part of the window lists the setting parameters such as Frequency or Delay. The parameters that can be set for each of the channels are listed in tabular form.
5. A pop-up menu appears when an item is selected in the table, pushing the **SELECT** button or right-clicking the mouse on the selected item displays the menu items corresponding to the item.

For Format, Polarity, or Mode selections, first display the pop-up menu, then select the parameter.

6. The scroll bar is activated when the mouse is attached. Scroll the cursor to display the hidden tables outside the display area.

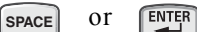
Table 2-32: Timing, Level, Data-Listing Window operation

Key	Description
	To navigate through items in the parameter area, use the TAB key.
	To move the cursor through items within the table, use the Up, Down, Left or Right arrow key.
	In Polarity, Jitter Range in the Timing window, In Limit, Output in the Level window, you can toggle between its two options by pressing the SPACE or ENTER key.
	For numeric parameters such as Delay or PW/Duty, enter numeric values using numeric keys or the knob. See Numeric Input on page 2-50.
	You can select either View By Channel or View By Group window display. You can toggle between the two by using View menu in the Data-Listing or Data-Waveform windows.

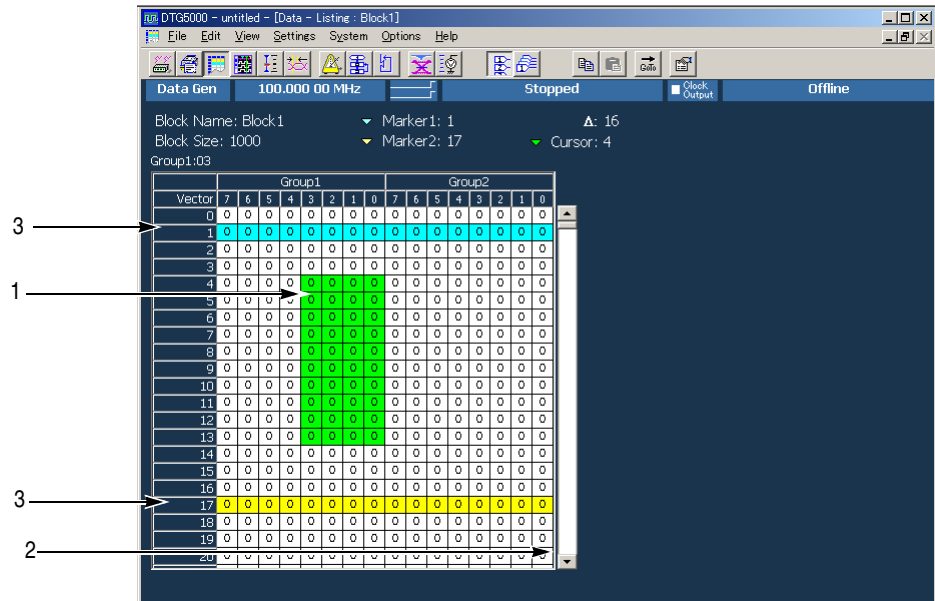



Figure 2-25: Window operation 3: Data-Listing window

In the Data-Listing and Data-Waveform windows you can create or edit data. The edit window allows you to use the cursor and markers to define the edit range.

Table 2-33: Data-Listing, Data-Waveform Window operation

Key operation	Description
 SHIFT + 	1. You can move the cursor in the vector or bitwise direction by using the Up, Down, Left, or Right arrow key. To specify the region, use the Up, Down, Left, and/or Right arrow keys while pressing the SHIFT key. Specifying the region is available within the same group. It is not allowed to define the region beyond the group.
	2. The scroll bar is activated when the mouse is attached. Scroll the cursor to display the hidden tables outside the display area.
	3. The two markers are used to specify the range. To move the markers, select Move Marker To... from the Edit menu to display the Move Marker To dialog. Then, enter the value to each field. You cannot move the markers with front panel keys or knob. You can move the markers by dragging a mouse in the Data-Waveform window.

Table 2-33: Data-Listing, Data-Waveform Window operation (cont.)

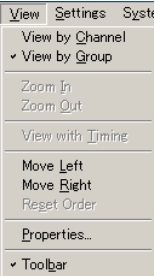
Key operation	Description
 OR 	<p>All the edit or viewing operation are selected from the menu. Use the Edit menu or the pop-up menu displayed by pushing the SELECT button.</p>
	<p>You can select either View By Channel or View By Group window display. You can toggle between the two by using View menu in the Data-Listing or Data-Waveform windows.</p>

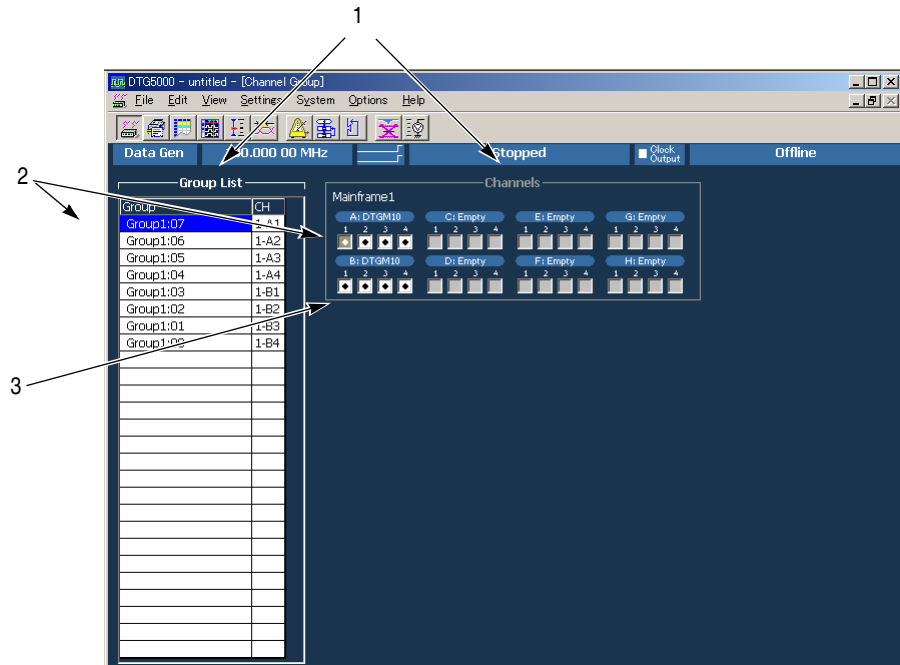

Figure 2-26: Window operation 4: Channel Group window

In the Channel Group window you can assign the logical channels and physical channels. The *Group List* on the left window pane lists the logical channels in the Group column. The Channels on the right side list the physical channels.

Table 2-34: Channel Group Window operation

Key operation	Description
	1. You can toggle between Group List and Channels using the TAB key
	2. To select a logical or physical channel, use the Up, Down, Left, and/or Right arrow keys.
	3. After selecting the physical channel in the Channels, pressing the ENTER key makes the physical channel assign to the logical channel preselected in the Group List. When you are using the mouse, you can make the assignment by clicking the mouse in the physical channel box. With the physical channels listed in the Group List (CH column), bullets are added to the boxes associated with the assigned physical channels in the Channels. After you have selected one of already assigned physical channels (indicated by bullets) in the Channels, pressing the ENTER key resets (deassigns) the assignment with the logical channel. If you are using the mouse, you can reset the assignment by clicking the mouse in the assigned physical channel.
or	To create, resize or deassign a group, or create a predefined group, use the Edit menu or the pop-up menu displayed by pushing the SELECT button.

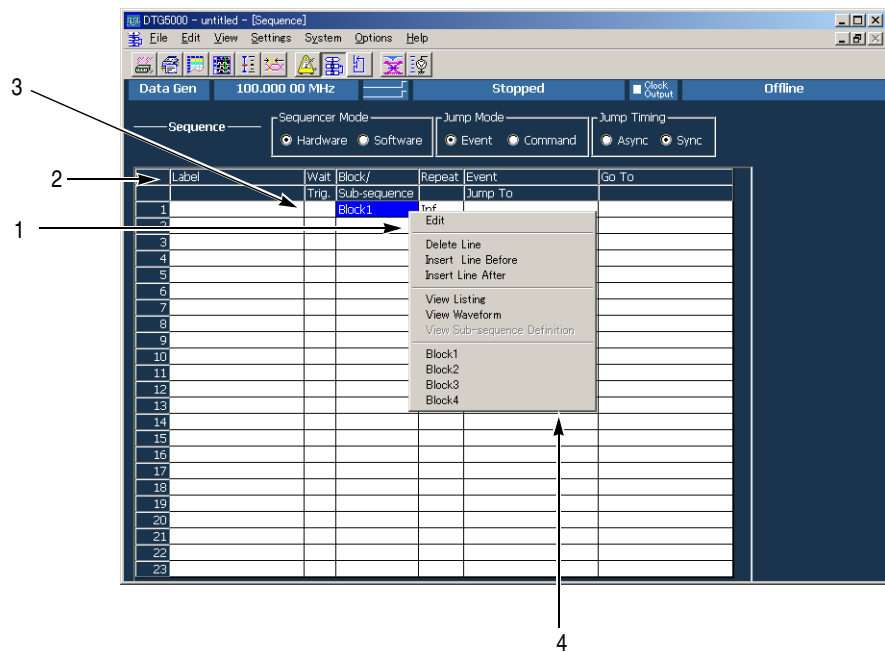

Figure 2-27: Window operation 5: Sequence window

In the Sequence window you can create a sequence by combining blocks and subsequences. This window is also in tabular form like other windows. This window allows you to input the characters.

Table 2-35: Sequence Window operation



Key operation	Description
	1. To move the active cell through the table, use the Up, Down, Left, and/or Right arrow keys.
	2. Any cell in this window accepts characters and digits you entered. To enter characters to Label or Event Jump To column, press the front panel ALPHA key to activate the text input mode and then use numeric keys. See Text Input on page 2-50.
or	<p>3. To specify On for Wait Trig. or Inf. for the Repeat, use the Edit menu. You can also use the SELECT button to display the pop-up menu. See page 2-41 for information on how to use the data timing generator menu system.</p> <p>4. The blocks and subsequences already defined in the Blocks or Subsequence window are listed in the Edit menu, which allows you to specify the block or subsequence in the Block/Subsequence column. You can also specify the block or subsequence by using the SELECT button and pop-up menu.</p>

Numeric Input

Any numeric input box has a unit attribute according to the setting. The unit attribute s is for the time, V for the voltage, Ω for the resistance, or nothing for the count or size. The data timing generator recognizes the range of the acceptable parameter values. If you enter a value outside the valid range, the maximum or minimum value will be set automatically. To enter a numeric value, use either numeric keys or the knob.

Using the Numeric Keys. Auxiliary unit keys such as k/m and M/μ are available. For k (kilo-), m (milli-), M (mega-), and their related units, the one suitable for the parameter is selected automatically.

Table 2-36: Example of Numeric Keys input

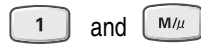
Key operation	Description
Example 1: Amplitude 	If you press in this order, 0.5 V is entered.
	If you press in this order, 0.5 V (500 mV) is entered.
Example 2: Term Z 	If you press in this order, 50 Ω is entered.
	If you press in this order, 1 MΩ is entered.

Using the Knob. If a numeric value is accompanied with an underbar, you can use the knob for editing it. The digit accompanied with an underbar can be edited.

To move the underbar to the target digit to be edited, use the Left and/or Right arrow key under the knob. See Figure 2-3 for the location of the key.

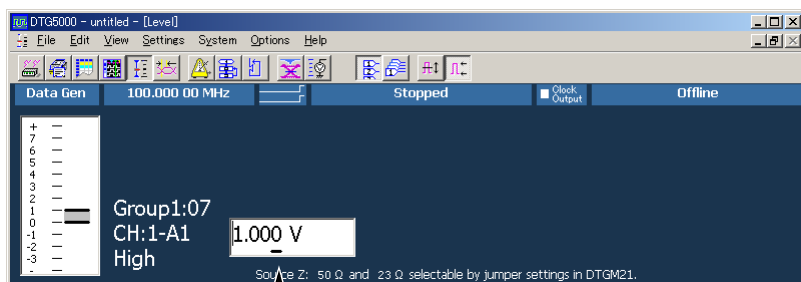
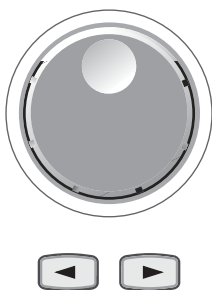

A numeric value accompanied with underbar

Using the External Keyboard. Numeric keys above the alphabetical letter keys, not those on the numeric keypad, are available on the external keyboard. The k (kilo-), M (mega-), G (giga-), m (milli-), μ (micro-), n (nano-) and p (pico-) keys are available for auxiliary units.

Text Input











To enter text from the front panel, use the **ALPHA**  key and numeric keys. Push the  key to activate the text input mode. In this mode, you can enter characters that are printed above each numeric key. The ALPHA key's LED stays lit  if the text input mode is selected.

Table 2-37: Example of Numeric Keys input

Key operation	Description
 	<p>Indicates DtG5000 is in the numeric input mode. Pressing this key changes in the text input mode.</p> <p>Indicates DtG5000 is in the text input mode. Pressing this key changes in the numeric input mode.</p>
	<p>By pressing a numeric key repeatedly, the characters indicated above the key are displayed</p> <p>Example: Pressing the 8 key displays a at the caret. If you press the 8 key repeatedly, the character changes to b, c, A, B, C and 8 in order.</p>
another numeric key or  	<p>When you press another numeric key or the Left or Right arrow key, the character currently displayed is determined and the caret moves.</p>
another numeric key or 	<p>By pressing the ENTER key or another numeric key, the character is also determined.</p>
Any key unrelated to text input or  	<p>If you press a key unrelated to text input or the ESC key, or use the ENTER key to determine the character, the mode automatically changes from text input to numeric input.</p>

File Operations

To save or load the setup file or import data that has been created on another device, use the Windows standard file I/O dialog box. The data timing generator file operations are the same as the general PC file operations. If the mouse is not used, several restrictions are applied to the file operations.

Selecting a file. Do the followings steps to select a file without using a mouse.

Table 2-38: Selecting a file











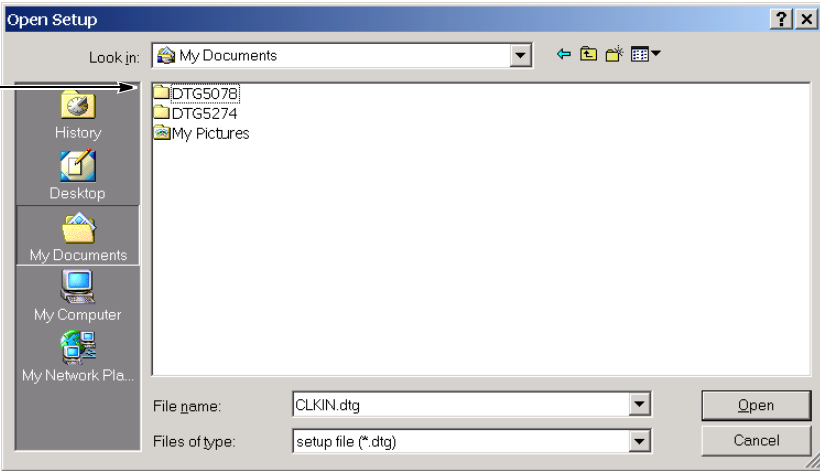

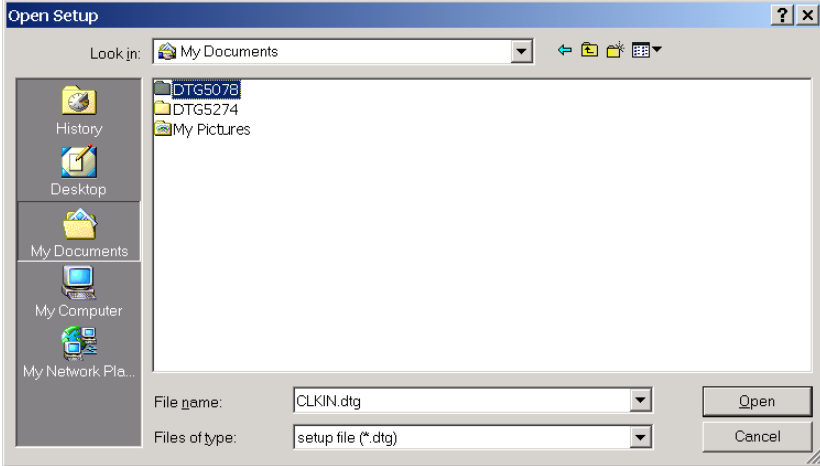
Screen	Key operations
	<p>1. Press the  key repeatedly to activate the file view.</p>
	<p>2. Browsing a folder:</p> <ul style="list-style-type: none">   :select the folder.  : open the folder  : move the folder hierarchy up

Table 2-38: Selecting a file (cont.)

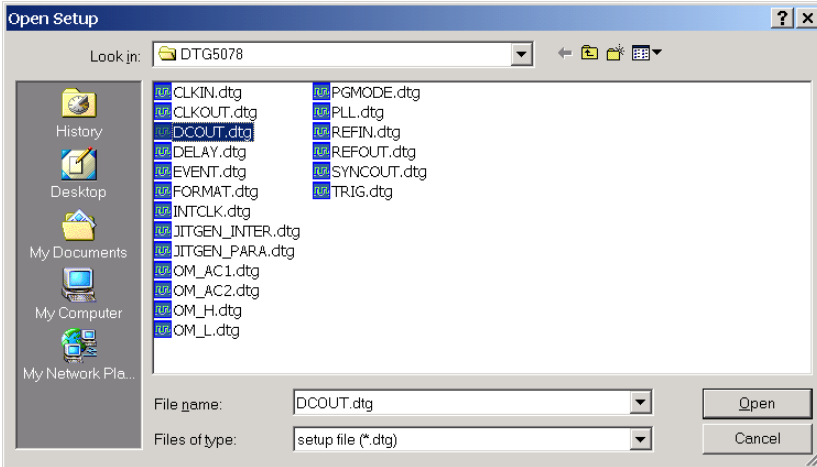
Screen	Key operations
	<p>3. Specify the file:</p> <p>   </p> <p>   : Select the file </p> <p>  : Open the file </p>

Key Operations

Table 2-39 summarizes the data timing generator key operations.

Table 2-39: Key operations













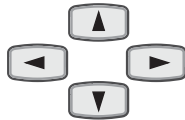
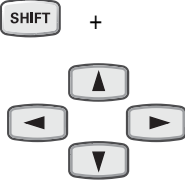

Items	Description
	Displays the last menu you opened on the menu bar.
	Moves the focus through items in the window. Pressing SHIFT and TAB keys simultaneously reverses the moving direction.
	Moves the cursor through items on the menu, moves the caret during text input, or selects a radio button.
	Selects multiple items (Data-Listing/Data-Waveform window), or shifts the current line (SHIFT + Up/Down arrow key only; Timing/Level window).

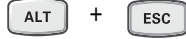
Table 2-39: Key operations

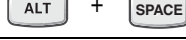
Items	Description
	Changes a numeric value, moves the cursor through menu items, moves the focus in a table or list, moves the cursor through the Data-Listing or Data-Waveform window, toggles between multiple items for a parameter in the Timing/Level window (NRZ/RZ/R1, On/Off, Normal/Invert, Normal/AND/XOR, etc.), or selects an item from a combo box.
 Digit Select arrow keys	Located just below the knob. Moves the cursor through digits while using the knob to enter a numeric value. Refer to page 2-3.
	Turns on or off the check sign in a check box, or toggles between two options for a parameter in the Timing or Level window (On/Off, Normal/Invert, etc.).
	Activates the menu bar.
	Switches the active application.
	Switches the application (selected with icon display).
	Displays window control menu. You can move/resize/close the window.
	Exits the application. (Available only from the external key board)
	Cancels text input or a dialog box. Cancels display of a menu opened with the SELECT key. To cancel a menu opened with the MENU key, press ESC key twice.
	Switches the active window in the application.
	Moves the cursor between digits during numeric input.
	Increments or decrements the value during numeric input.
	Displays the Windows Start menu.
	Forcibly exits the application. (Available only from the external key board)

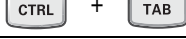
Keyboard and Mouse

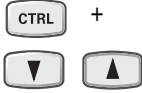
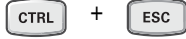
As the standard accessories, a USB keyboard and USB mouse are shipped with the data timing generator. Though it is possible to operate the instrument only with front panel controls, attaching the mouse and external keyboard to the data timing generator mainframe makes the operation more easily. Read the following topics related to the mouse and external keyboard.

When you set up the Windows operating system or perform the system recovery, the external keyboard and mouse are required.

You can connect or remove the USB devices while the data timing generator powered on.

Mouse.

- Using a mouse allows you to access the toolbar icons, each window buttons and scroll bar which cannot be accessed from the data timing generator front panel controls.
- In the data editing windows such as Data-Listing or Data-Waveform, or in the setup windows such as Timing or Level, you can access the area you cannot access from the keyboard. By dragging, right clicking or left clicking the mouse allows you to access those functions.

Keyboard.

The Delete and Back space (BS) functions are assigned to a single key. To use it as BS, press **Fn+Delete**. If you want to use a key as labeled on the key front (such as BS, F1, F2...), press it while holding down the **Fn** key.

- The  key operates as the Windows key.
- You can assign the **Delete** key to the **BS** key using a SW3 DIP switch located on the back. In this case, you can input **Delete** by pressing **Fn+'**. For details of the DIP switches, refer to the underside of the keyboard.
- After you power on the instrument for the first time, you have to set up Windows. Connect the keyboard supplied with the instrument before turning on the power.

NOTE. *If you need to perform the system recovery, you must use a PS/2 keyboard and PS/2 mouse.*



Data Structure

Data Structure

This section contains the following two subsections, which provide information on the DTG5000 Series Data Timing Generator data structure.

- *Internal Pattern Data* section explains the data timing generator objects such as channel, group, block and sequence.
- *Grouping and Channel Assignment* section defines the groups and provides basic information on how to use the Channel Group window.

Internal Pattern Data

This section explains the meanings of the data included in the windows. The data in the DTG software consists of the channel, group, block, and sequence objects. This section details them in order.

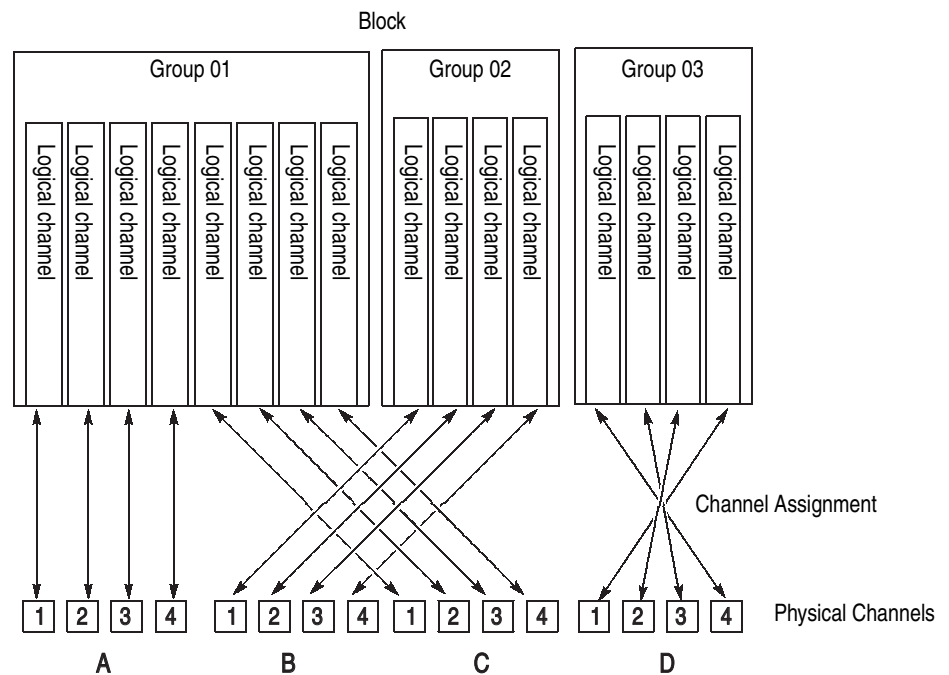

Figure 3-1: Channels, groups, blocks and channel assignment

Logical Channel

The data timing generator has two types of channels: logical and physical. Logical channels represent one-bit pattern data. The number of logical channels is 32 (4 channels x 8 slots) for the DTG5078, or 8 (2 channels x 4 slots) for the DTG5274 and DTG5334.

Logical channels themselves do not have the concept of length. The length of the pattern data on a logical channel is the block size defined in the Blocks window. Each piece of the pattern data has a value of 0 or 1. To create the pattern data, you can use the Data-Listing or Data-Waveform window.

One of the key features of the data timing generator is that each logical channel has its attribute value of the output setting parameters such as the output level, pulse width or delay time. You can set these parameters using the Level and/or Timing windows.

Physical Channel

Physical channels are defined as the hardware channels of an output module installed in the data timing generator mainframe.

The number of physical channels available for the system is determined by the mainframe type and the types and number of output modules installed. Refer to Table 3-1..

Table 3-1: The number of available physical channels

Output module (on module)	DTG5078	DTG5274, DTG5334
DTGM10 (4)	4	2
DTGM20 (4) DTGM21 (4)	4 4	2 2
DTGM30 (2)	2	2
DTGM31 (1) DTGM32 (1)	1 1	1 1

The DTG5000 software has the output setup parameters, such as the output level or clock frequency, in its logical channels. To output actual data pattern outputs, do the following:

- Specify the physical channels to output the data within the logical channels.
- Send the output setup parameter to the physical channels to operate the hardware properly.

To associate the logical channel with the physical channel (this is also called channel assignment), use the Channel Group window. Refer to *Window Operation 4: Channel Group Window* on page 2-48.

Groups A group is defined as a set of logical channels. Grouping functions is especially useful depending on the DUT. Several channels are sometimes used with the same output level and data format. In this case, handling multiple channels as one group is a useful method.

The number of logical channels that the system can accept is determined by the mainframe (32 for the DTG5078, 8 for the DTG5274, and DTG5334). In the Master-Slave operation mode, the number increases with the number of mainframes. The number of groups depends on how many groups the user divides into the logical channels. The total number of logical channels in each group cannot exceed the number of logical channels that the system can accept. By default, every logical channel is divided into an eight-channel group. To add a new group, you have to delete some groups or decrease the number of logical channels in a group to secure the logical channels required for the new group.

To create, delete, rename or resize a group, use the Channel Group window.

Blocks A block is defined as a set of groups that consist of logical channels. The block is an elementary data of signal output. To specify the block length, use the block size located in the Blocks window. The block size represents the pattern data length, or vector length. The block width is the sum of bit width in the group to which it belongs, that is, the total number of logical channels.

By default, one block named Block1, whose size is 1000, is created.

Creating multiple blocks enables you to generate repetitive signal outputs by the blocks or sequential outputs with jumps. Even if two or more blocks exist in the system, only one method can be used for either grouping or channel assignment.

To create, rename, or resize a block, use the Blocks window.

Use the Data-Listing or Data-Waveform window to edit values (0 and 1) in the individual pattern data. Editing is possible by the block unit. To specify the block to be edited, you can use **Select Block...** from the Edit menu of the Data-Listing or Data-Waveform window, or use **View Data-Listing** or **View Data-Waveform** from the Edit menu of the Blocks window.

To set the voltage output setting parameter, use the Level window. To set the timing output setting parameter, use the Timing window. Both parameters can be set by the channel unit (except for clock frequency), but not by the block unit.

Sequence A sequence consists of blocks and subsequences. As the subsequence elements, one or more block names and the repetition of the blocks are defined. Using a sequence, you can output complex signals by defining blocks, number of times the subsequence repeats, and jump conditions.

By default, a sequence that continuously repeats Block1 is provided. To create a sequence or subsequence, use the sequence table in the Sequence window or Subsequence window.

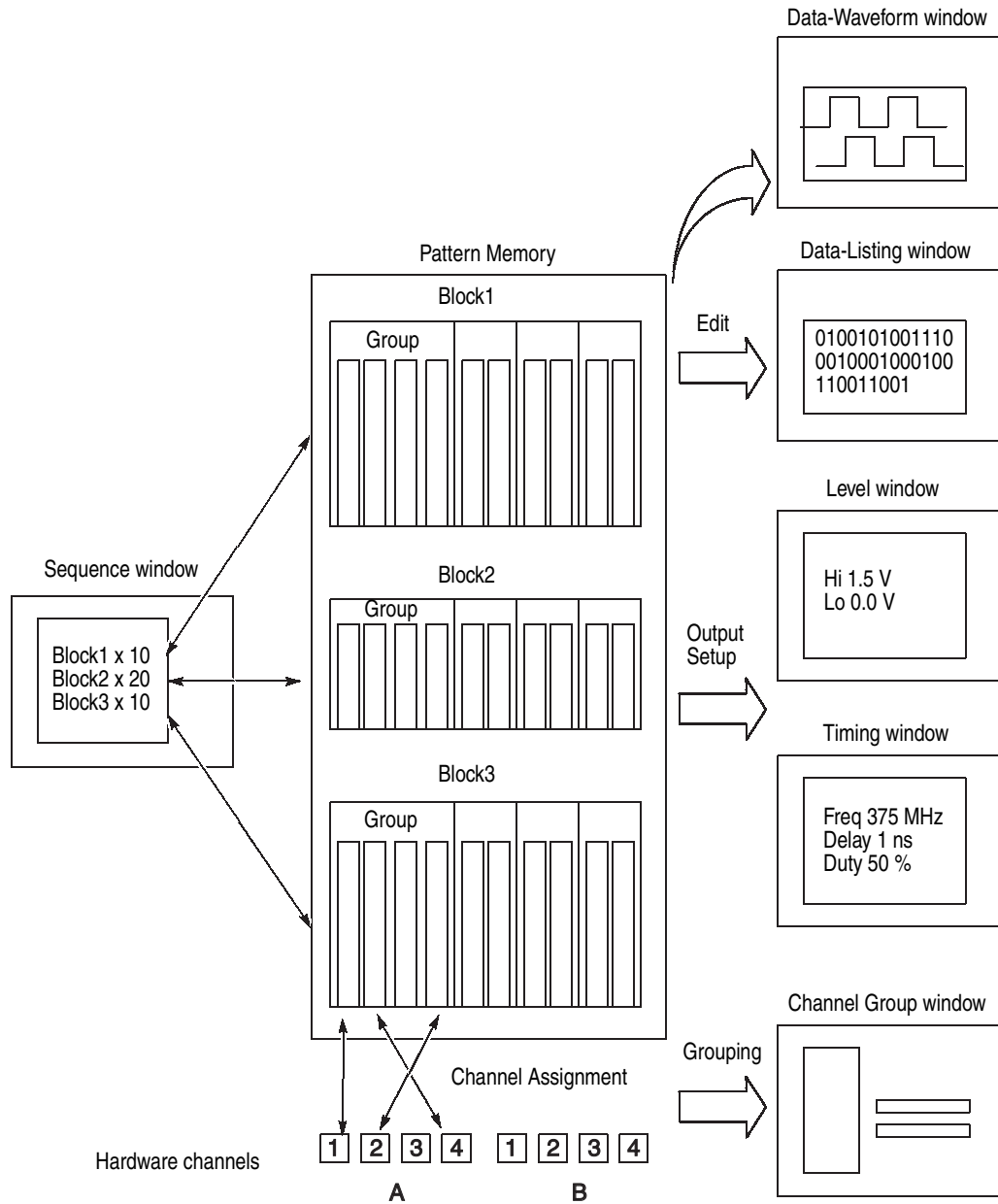

Figure 3-2: Concept of data and window

Grouping and Channel Assignment

Grouping collects channels in a single group to enable setup, edit or display by group. To define a group or perform a channel assignment, use the Channel Group window. You can use the grouping function only in the Data Generator mode.

Defining a Group

A group is defined by the name and the channels included in the group. The defined group and channels are used for display by the channel or by the group in the Data-Listing, Data-Waveform, Timing, or Level window.

The channels to be defined are logical channels but not physical channels, which are actually installed to the hardware. The pattern data you created by pattern edit and the setting parameters such as the voltage and/or delay are attributes with logical channels.

Assigning a Channel

To output a signal, you must assign the previously defined logical channels to physical channels. See Figure 3-3.

- Assign only one physical channel to one logical channel.
- Channel assignment can be performed, regardless of the bit sequence in the group; any physical channels can be assigned to logical channels as desired.
- You can define the logical channels without being assigned to physical channels.
- The physical channels that are not assigned to the logical channels do not output any signals.

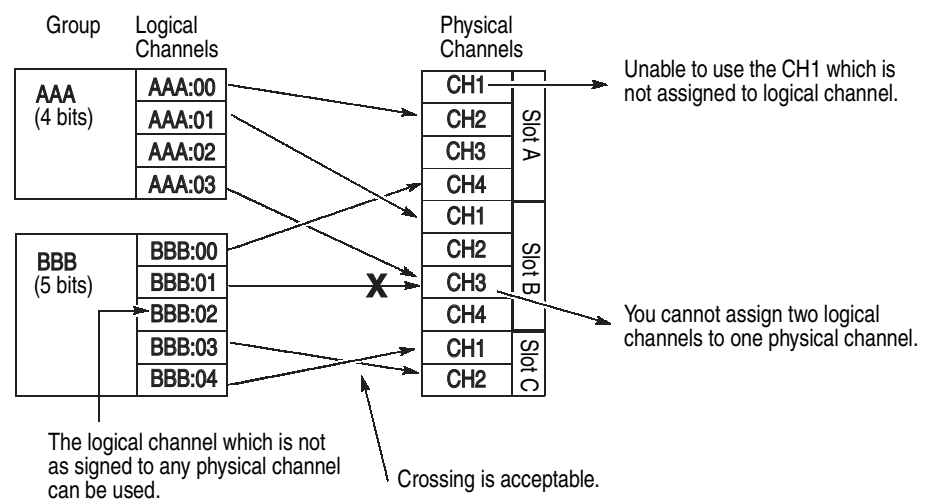
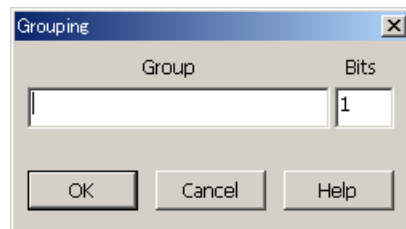

Figure 3-3: Channel assignment

Creating a New Group

To create a new group, there must be a logical channel not assigned to a group. By default, every logical channel has been assigned to groups in the data timing generator mainframe. You must delete several groups to make the logical channels available before creating a new group.

1. Push the front panel **MENU** button.
2. Select the Edit menu, and then select **New Group...**
Alternatively, place the mouse pointer in the Group List table and right-click, then select **New Group...**
3. The Grouping dialog box appears.



4. Enter a group name and the number of bits (number of logical channels) in the dialog box.
5. Select **OK** to create a new group.

Renaming and Resizing a Group

You can rename an existing group or change the number of its logical channels.

1. If the Group List is not activated on the screen, activate it by pressing the **TAB** key.
2. Select the target group using the Up or Down arrow key.
3. Push the front panel **MENU** button.
4. Select the **Edit** menu, and then select **Rename/Resize Group...**
Alternatively, place the mouse pointer in the Group List table and right-click, and then select the **Rename/Resize Group...**
5. Edit the group name and the number of bits (the number of logical channels) in the Grouping dialog box.
6. Select **OK** to complete the change.

Deleting a Group

You can delete the particular group(s) you selected or all the groups.

1. Activate the Group List in the Channel Group window.
2. To delete a group, select the group by using the Up or Down arrow key.
3. Push the front panel **MENU** button.
4. Select the **Edit** menu, and then select **Delete Group** or **Delete All Groups**. Alternatively, place the mouse pointer in the Group List table and right-click, and then select the **Delete Group** or **Delete All Groups**.
5. Select the menu option (Delete Group or Delete All Groups) to display the confirmation dialog box.
6. Select **OK** to delete the group(s).

Selecting a Preset Grouping Option

The following three combinations of a group and its logical channel are provided in the data timing generator.

- 8 channels per group
- 1 channel per group
- All channels per group

To select one of these options, do the following.

1. Activate the Group List in the Channel Group window.
2. Push the front panel **MENU** button.
3. Select the **Edit** menu, and select **Preset**, and then select **8 Channels per Group** or **1 Channel per Group** or **All Channels in One Group**.

Alternatively, place the mouse pointer in the Group List table and right-click, then select the **Preset**, and then select **8 Channels per Group** or **1 Channel per Group** or **All Channels in One Group**.

4. Select the menu item to display the confirmation dialog box.
5. Select **OK** to create the group.

Channels Physical Channel

The physical channel is identified by the mainframe number (1 to 3; for Master-Slave configuration), slot location (A to H), and channel number (1 to 4).

The installed physical channels are displayed in the right window pane of display area. Any channel indicated by a bullet in a white rectangle has already been assigned to a logical channel.

Assigning a Channel

Do the following steps to perform the channel assignment.

1. Activate the Group List in the Channel Group window.
2. Select the target logical channel with the Up or Down arrow key.
3. Activate the Channels with the **TAB** key.
4. Select a physical channel with the Up/Down/Left/Right arrow keys.
5. Push the **SELECT** button to complete the assignment. The physical channel name is displayed in the CH column of the Group List, indicating that the assignment is complete.
6. For the logical channel in the left of Group List, the next lower line is selected automatically. The channel assignments can be performed in sequence by repeating the selection of a physical channel in the right Channels.

Using the Auto Assign Function

The Auto Assign function allows you to assign the physical channels (1-A1, 1-A2, 1-A3...) to the logical channels in the Group List sequentially.

1. Activate the Group List in the Channel Group window.
2. Push the front panel **MENU** button.
3. Select the **Edit** menu, and then select **Auto Assign**.

Alternatively, place the mouse pointer in the Group List table and right-click, then select **Auto Assign**.

4. A confirmation dialog box appears.
5. Select **OK** to perform the Auto-Assign.

De-assigning a Channel

You can de-assign a physical channel you selected. You can also de-assign all the physical channels currently assigned to logical channel(s).

1. Activate the Group List in the Channel Group window.
2. To de-assign a particular channel, select the channel with the Up or Down arrow key.
3. Push the front panel **MENU** button.
4. Select the **Edit** menu, and then select **De-assign** or **De-assign All**.
Alternatively, place the mouse pointer in the Group List table and right-click, then select the **De-assign** or **De-assign All**.
5. A dialog box appears to prompt you for confirmation. Select **OK**.
6. The channels you selected are de-assigned.



Tutorials

Tutorials

This section contains tutorials to help you learn how to operate the DTG5000 Series Data Timing Generator. These tutorials provide a good introduction to the following basic features of the data timing generator.

The data timing generator has a high degree of flexibility in combination of the mainframe and output modules. In this section, you can perform the tutorials under the assumption that the eight channel output modules (two DTGM10) are installed in the data timing generator mainframe (DTG5078).

To familiarize the first-time user with the data timing generator, the following tutorials focus on the front panel operations. In the actual signal output tasks, you can perform the operations more easily by using a mouse and a keyboard.

Before Applying Power to the Mainframe

Install two DTGM10 output modules to slot A and slot B of the mainframe. Refer to *Output Module* on page 1-9 for installation and removal of output module. Then, power on the mainframe. Refer to *Powering On the Data Timing Generator* on page 1-12.

Online Mode and Offline Mode

The data timing generator starts in the mode in which it was powered off last time. The offline mode enables you to set the whole process from creating pattern data to setting up output parameter on the PC, except for the data timing generator hardware control. To output a pattern, you must operate the data timing generator in the online mode. If the data timing generator is running in the offline mode, do the following steps to change the mode to online.

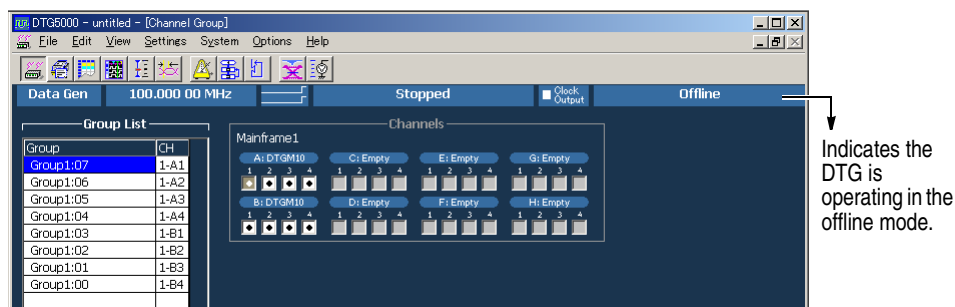

Figure 4-1: Confirming Offline mode

1. Exit the DTG5000 software.
 - a. Push the **MENU** button, and then select **Exit** from the **File** menu using the Up, Down, Left, and/or Right arrow key.

- b. Push the **SELECT** button to exit the DTG5000 software.
 2. Start the DTG5000 Configuration Utility software.
 - a. Press the **CTRL+ESC** keys to open the Windows **Start** menu.
 - b. Using the Up, Down, Left, and/or Right arrow key, select **Programs > Tektronix > DTG5000 > DTG5000 Configuration Utility**, and then press the **ENTER** key.
 3. Use the DTG5000 Configuration Utility to set the mode to Online.
 - a. Press the **TAB** key repeatedly to activate the Mode selection.
 - b. Select **Online** using the Left or Right arrow key.

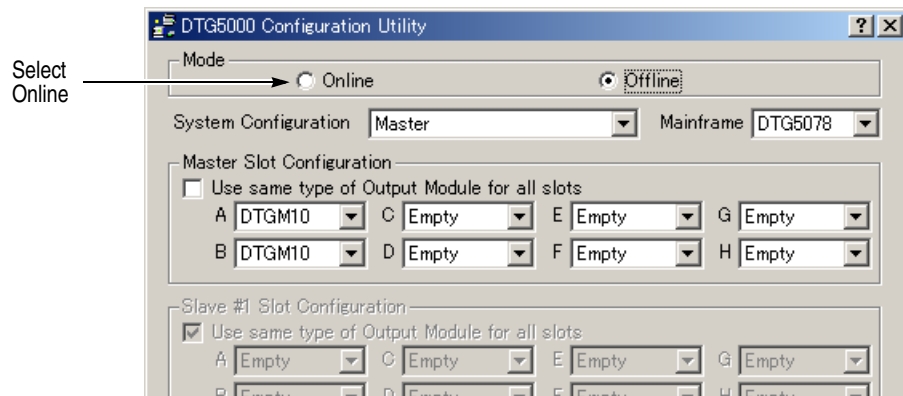

Figure 4-2: Select the online mode

- c. The DTG5000 Configuration Utility window changes to online mode. Press the **ENTER** key.
 - d. A dialog box appears to prompt you to restart the data timing generator. Press the **ENTER** key.
 4. Restart the DTG5000 software.
 - a. Press the **CTRL+ESC** keys to open the **Start** menu.
 - b. Using the arrow key, select **Programs > Tektronix > DTG5000 > DTG5000**, and then press the **ENTER** key to restart the DTG5000 software.

Arrow Keys There are two types of arrow keys on the data timing generator front panel.

Up, Down, Left, and Right arrow keys. These arrow keys are generally used to move the cursor position or to navigate the menu items.

Digit Select arrow keys. These arrow keys are used to specify the digit to be edited while using the knob to enter a numeric value.

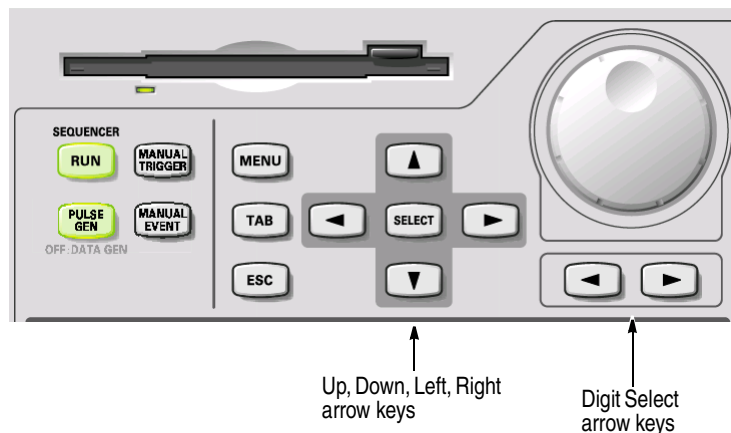

In the following tutorials, the Up, Down, Left, and Right arrow keys are simply called “arrow keys”.

Tutorial 1: Pulse Generator Mode

In this Tutorial 1, operate the data timing generator in the Pulse Generator mode, and run the mainframe to output a pulse. Verify that the output signals vary by changing several parameters.

Starting Pulse Generator Mode

Starting the DTG5000 software causes the data timing generator to start in the Data Generator mode.

1. Push the front panel **MENU** button, select **Default Setup** from the **File** menu using the arrow keys, and then push the **SELECT** button.
2. Push the front panel **PULSE GEN** button to enter the Pulse Generator mode. The Timebase window appears. In this window, you can set up parameters related to the clock, run mode, and trigger. Use the default settings in this tutorial. Confirm that **Internal** is selected in the Clock Source and **Continuous** is selected in the Run Mode.

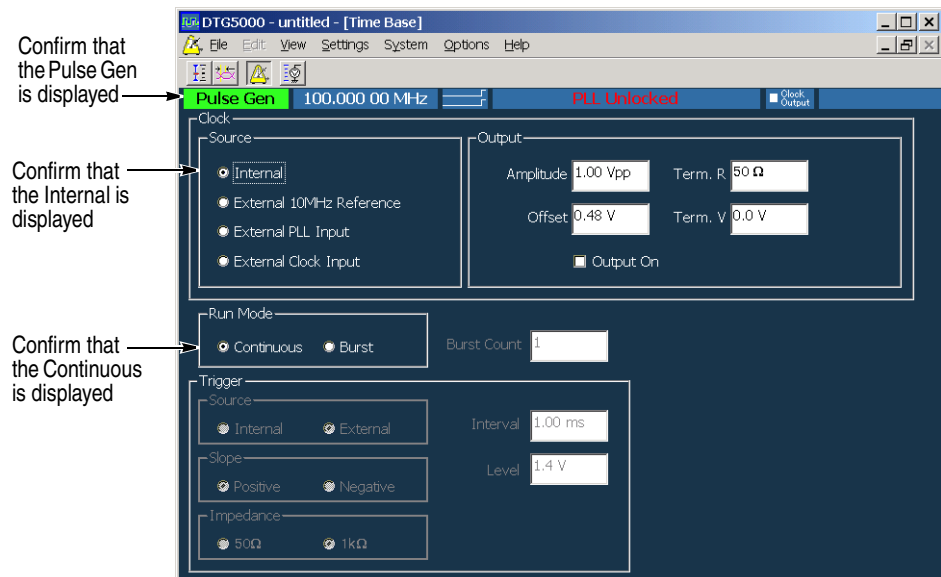

Figure 4-3: Time Base window (Pulse Generator mode)

Browsing the Window

1. Push the **MENU** button, select **Level** from the **Settings** menu using the arrow keys, and then push the **SELECT** button. Alternatively, push the front panel **LEVEL** button.

The Level window appears. In this window, you can set up parameters related to the output level. By default, this window shows the High level (1.000 V) and Low level (0.000 V) settings. You can use the default settings in Tutorial 1. For the Level window screen sample, see Figure 4-4.

2. Push the **MENU** button, select **Timing** from the **Settings** menu using the arrow keys, and then push the **SELECT** button. Alternatively, push the front panel **TIMING** button.

The Timing window appears. In this window, you can set up parameters related to the time base such as the output frequency, delay, and/or rise time. For the Timing window screen sample, see Figure 4-5.

Output a Signal

Output a signal with the default settings.

1. Push the front panel **LEVEL** button to open the Level window.

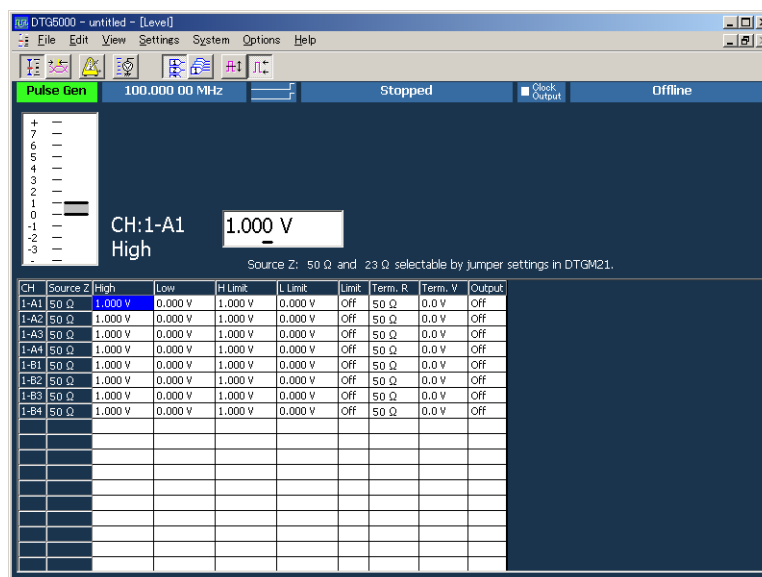
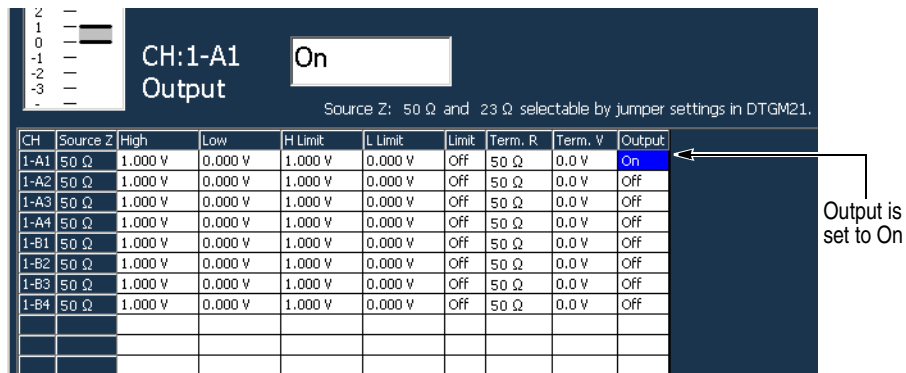

Figure 4-4: Level window (Pulse Generator mode)

2. Confirm that the **View by Channel** is selected in the **View** menu.
3. Do the following substeps to turn the **Output** on:
 - a. Move the cursor to **Output 1-A1** using the arrow keys.

- b. Push the **SELECT** button to open the pop-up menu, select **On** using the arrow keys, and then push the **SELECT** button. The **Output** for the 1-A1 channel is set to **On**.

Alternatively, you can press the **SPACE** or **ENTER** key to toggle between On and Off.



NOTE. When the cursor is placed in a table in the Level, Timing or other windows, you can push the **SELECT** button to open the corresponding pop-up menu that contains the commands for the current field. At the top, this menu shows the setup parameter values specific to the item you selected. You can see the same list in the Edit menu which you can access by pushing the **MENU** button.

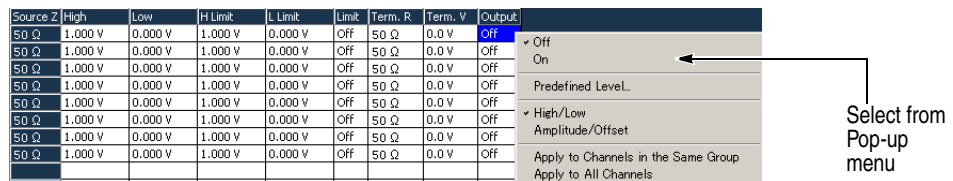

- c. Press the Down arrow key to move the cursor to the 1-A2 channel. Press the **SPACE** key to switch the channel status from **Off** to **On**.
- d. Turn the outputs of 1-A3 and 1-A4 channels to **On** in the same way. The LEDs stay lit up on the output connectors.

4. Push the front panel **RUN** button to output the pulse signal.

Level Window Operations

The following steps introduce a variety of operations you can perform in the Level window.

- 1. Set the numeric values in the following ways.

- a. Using the arrow keys, move the cursor to **High** for the 1-A1 channel. Press the Digit-Select arrow keys under the knob to move the underscore to the bottom of **1**. You can change the value for the digit by turning the knob. Change the setting to 2.000 V.
 - b. Using the Right arrow key, move the cursor to **Low** for the 1-A1 channel. Press the numeric keys **-** and **1**, and then press the **ENTER** key. The Low is set to -1.000 V.
 - c. Using the Right arrow key, move the cursor to **H Limit**. Press the numeric key **2**, and then press the **ENTER** key. The H Limit is set to 2.000 V.
 - d. Push the **SELECT** button to display the pop-up menu. Using the arrow keys, select the **Apply to All Channels**, and then push the **SELECT** button. The H Limit for every channel is set to 2.000 V.
 - e. Using the Right arrow key, move the cursor to **L Limit**. Press the numeric keys **-**, **0**, **.** and **5**, and then press the **ENTER** key. The L Limit is set to -0.500 V.
 - f. Push the **SELECT** button to display the pop-up menu. Using the arrow keys, select the **Apply to All Channels**, and then push the **SELECT** button. The L Limit for every channel is set to -0.500 V.
 - g. Using the Right arrow key, move the cursor to **Limit**. You can press the **ENTER** or **SPACE** key to toggle between Off and On.
 - h. If you set the Limit to **On**, the Low value you have set in Step **1-b** changes to -0.500 V. This is because the value you have set with the L Limit applies to the Low value.
2. Use the Predefined Level to set the level.
 - a. Using the arrow keys, move the cursor to **High** for the 1-A2 channel. Push the **SELECT** button to open the pop-up menu, select the **Predefined Level...** using the arrow keys, and then push the **SELECT** button. The Predefined Level dialog box appears.

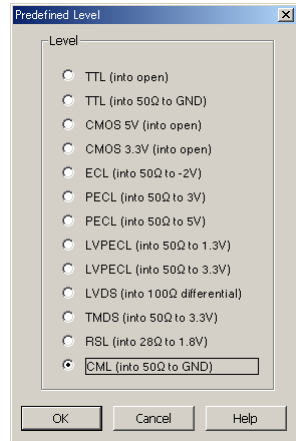

- b. Select **CML (into 50 Ω to GND)** by using the arrow keys.
- c. Select **OK** by pressing the **TAB** key, and then press the **ENTER** key.
- d. Each parameter of the 1-A2 channel is set to the predefined value.

The 1-A2 is set to predefined level

CH	Source Z	High	Low	H Limit	L Limit	Limit	Term. R	Term. V	Output
1-A1	50 Ω	2.000 V	-0.500 V	2.000 V	-0.500 V	On	50 Ω	0.0 V	On
1-A2	50 Ω	0.000 V	-0.410 V	0.000 V	-0.410 V	Off	50 Ω	0.0 V	On
1-A3	50 Ω	1.000 V	0.000 V	1.000 V	0.000 V	Off	50 Ω	0.0 V	On
1-A4	50 Ω	1.000 V	0.000 V	1.000 V	0.000 V	Off	50 Ω	0.0 V	On

3. Select the **Apply to All Channels** to set all the channels to the same setting.
 - a. Move the cursor to **High** for the 1-A2 channel and push the **SELECT** button, and then select the **Apply to All Channels** using the arrow keys.
 - b. Push the **SELECT** button to set the **High** value for every channel to 0.000 V.
 - c. Move the cursor to **Term.V** using the Right arrow key. If there is any different setup parameter in **Term.V** cell, use the **Apply to All Channels** command to change the parameters.
4. By using the front panel **ALL OUTPUTS ON/OFF** button, you can turn on or off the Output switch in the **Output** cell for each of the channels.
 - a. Currently, the 1-A1 through the 1-A4 channels are **On**, and the others are **Off**.
 - b. By pushing the **ALL OUTPUTS ON/OFF** button, you can toggle between On and Off for all the channels. Push the button twice to turn on all the channels.

When you push the **ALL OUTPUTS ON/OFF** button, all the channels are turned off if there is any channel set to On. The Output for all the channels toggles between On and Off each time you push the button.

Timing Window Operations

The following steps introduce some of the operations you can perform in the Timing window.

1. Push the front panel **TIMING** button to open the Timing window.

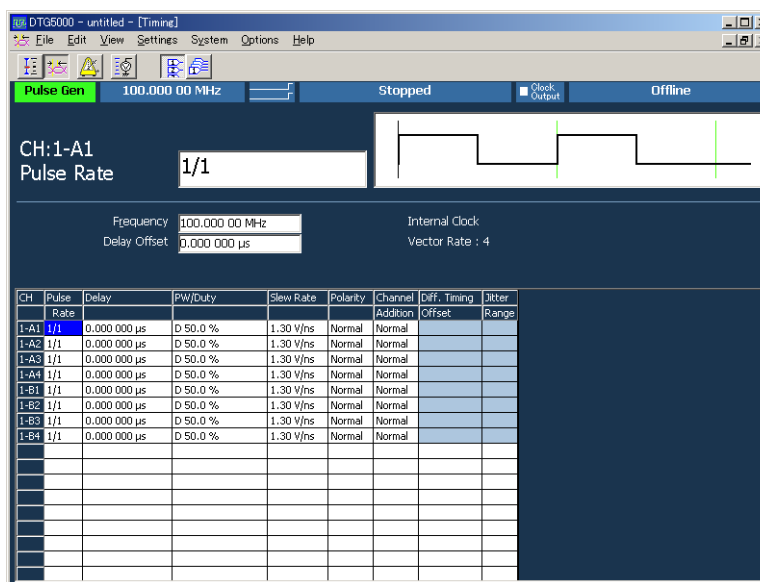

Figure 4-5: Timing window (Pulse Generator mode)

2. Do the following substeps to change the **Duty** setting of the pulse:
 - a. Using the arrow keys, move the cursor to **PW/Duty** for the 1-A1 channel.
 - b. Press the Digit-Select arrow keys to move the underscore to the unit place.
 - c. Turn the knob to decrease or increase the Duty setting of the pulse. The pulse width of output signal also varies concurrently. Change the setting to 25.0 %.
 - d. Press the Down arrow key to move the cursor to **PW/Duty** for the 1-A2 channel.

- e. Push the **SELECT** button to open the pop-up menu.

You can display the same list in the **Edit** menu using either the **MENU** button or the Left and/or Right arrow keys.

- f. The menu contains **Duty(%)**, **Pulse Width(s)**, and **Trail Delay(s)**. This means you can select duty ratio (%), pulse width (time), or falling edge (time) as the method for specifying the pulse width. You can select any option.

Select the **Pulse Width(s)** using the Down arrow key, and then press the **ENTER** key.

- g. The values previously shown as 50.0% with Duty is shown as **W 0.005000 μ s**. The **W** stands for Width.
- h. Press the numeric keys **2**, **.**, and **5**, then press the unit key **G/n**. Input of 0.002500 μ s (= 2.5 ns) is complete. In this way, you can set a numeric value by using the knob or numeric keys.
- i. Press the Down arrow key to move the cursor to **PW/Duty** for the 1A-3 channel.
- j. Push the **SELECT** button to open the pop-up menu, select the **Trail Delay(s)** using the Down arrow key, and then press the **ENTER** key.
- k. If you use the Trail Delay for setting, the values will be shown as **T 0.005000 μ s**. Press the numeric keys **2**, **.**, and **5**, then press the unit key **G/n**. Input of 0.002500 μ s (= 2.5 ns) is complete.

3. Check the valid range setting.

- a. Press the Right arrow key to move the cursor to **Slew Rate**.
- b. The Slew Rate parameter is used to vary the pulse rising edge. The value is currently shown as 1.30 V/ns. If the valid range of the parameter value is not known, you can find the maximum and minimum valid values by entering extremely large and small values.
- c. Enter **9999** using numeric keys, and then press the **ENTER** key. The value in the input box is set to 1.30 V/ns.
- d. Enter **-9999** using numeric keys, and then press the **ENTER** key. The value in the input box is set to 0.65 V/ns.
- e. Steps **3.c** and **3.d** conclude that this parameter can be set in the 0.65 V/ns through 1.30 V/ns range.
- f. Turning the knob can also increase or decrease the value in the valid range.

4. Set the Polarity and Channel Addition parameters.

- a. Press the Right arrow key to move the cursor to **Channel Addition** for the 1-A3 channel. The Channel Addition function allows you to output the results from the composition of the signals of the current channel and another channel.
- b. In case you may not be sure what parameter values can be set, use the pop-up menu by using the **SELECT** button. Alternatively, use the **Edit** menu by using the **MENU** button and the arrow keys. At the top of the menus, the parameter values you can set are listed.
- c. Push the **SELECT** button to open the pop-up menu. From the displayed menu items, you can select either **Normal** or **XOR**, and the **Normal** is currently selected.

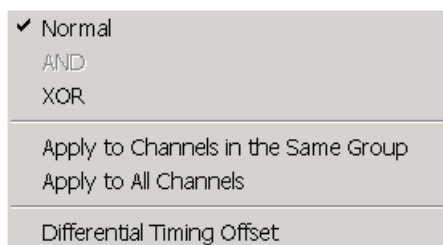

- d. Select **XOR** using the Down arrow key, and then press the **ENTER** key. You have set **XOR** (The XORed signal of the 1-A3 and 1-A4 channels is output).
- e. Press the Down arrow key to move the cursor to **Channel Addition** for the 1-A4 channel.
- f. Push the **SELECT** button to display the pop-up menu. You can select **Normal** or **AND**. This is because the XOR channel composition is not allowed with any even numbered channel. Select **AND**, then press the **ENTER** key. The ANDed signal of the 1-A4 and 1-A3 channels is output from the 1-A4 channel.
- g. Using the arrow keys, move the cursor to **Polarity** for the 1-A1 channel.
- h. The Polarity specifies the deflection polarity of the output signal by two parameters of **Normal** and **Invert**.

To select a parameter you must select from two options, you can press either the **SPACE** or **ENTER** key, in addition to using the **SELECT** or **MENU** button to select from the menu.

5. Push the **RUN** button to stop signal output.
6. Push the **ALL OUTPUTS ON/OFF** button to turn off the output switches for all the channels.

Saving a Setup File

To complete the Tutorial 1, you must perform one more procedure.

1. If you want to exit the tutorial now, push the **MENU** button, select **Exit** from the **File** menu, and then press the **ENTER** key. If you want to go to Tutorial 2 immediately, push the **PULSE GEN** button to enter the Data Generator mode.
2. When you have made changes to the original settings from the start of the Pulse Generator mode, a confirmation dialog box is displayed. Using the **TAB** key, select either the **Yes** or **No**, and then press the **ENTER** key. In this tutorial, select **Yes**.

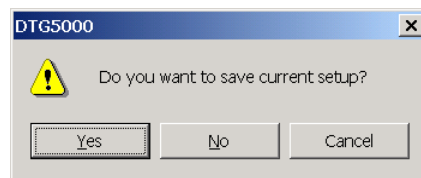

3. The Save Setup dialog box appears. Since it is identical to the Windows file save dialog box, you can use this dialog box with the same way as a Windows PC. In this example, you save the file from the front panel of the data timing generator.
 - a. Press the **TAB** key to activate the file view. The content of the folder specified in the **Save in:** box is displayed in the file view.
 - b. Select the file or folder using the Up and/or Down arrow keys. Refer to *File Operations* on page 2-52.
 - Select the file or folder in the file view area, then press the **BKSP** key to move into the higher folder.
 - Select the file or folder in the file view area, then press the **ENTER** key to open the file or folder.
 - c. Repeat the same steps to reach the target folder.
4. Press the **TAB** key to activate **File name:** input box. Enter the file name following the steps below:
 - a. Pressing the front panel **ALPHA** key makes the key LED light up to indicate the ALPHA input (character input) mode is activated.
 - b. For details of text input, refer to *Text Input* on page 2-51.

In the ALPHA input mode, by pressing the numeric key, you can input characters labeled on the key. In this tutorial, you name the file tutorial1.
 - c. Press **2** once to select **t**, then press the Right arrow key to enter **t**.

- d. Press **2** twice to select **u**, then press the Right arrow key to enter **u**.
- e. Press **2** once to select **t**.
- f. Press **6** once. The **t** is entered, and **m** is automatically selected at the right. Press **6** twice to select **o**.
- g. Press **1** three times. The **o** is entered and **r** is selected.
- h. Press **4** three times. The **r** is entered and **i** is selected.
- i. Press **8** once. The **i** is entered and **a** is selected.
- j. Press **5** three times. The **a** is entered and **l** is selected.
- k. Press **1** nine times to enter **1**. Digit **1** is selected.
- l. Press the **ENTER** key to enter **1**. Input of **tutorial1** is complete.
- m. The extension is assigned automatically. Press the **ENTER** key again. The settings file is saved under the name of *tutorial1.dtg*.

The DTG5000 Series data timing generator settings file contains all the output information such as the parameters, pattern data, grouping and channel assignment you have set in the windows in the Pulse Generator and/or Data Generator mode. You can restore the settings by loading the settings file using the **Open Setup** pull-down menu. This ends the Tutorial 1.

Tutorial 2: Data Generator Mode

To output a pattern in the Data Generator mode, you must perform the following steps.

- Grouping and channel assignment
- Creating a block
- Creating a pattern data
- Setting the output parameters

Default Setup

1. Do the following steps to restore the default settings.
 - a. Select the **MENU** button, select **Default Setup** from the **File** menu by using the arrow keys, and then press the **ENTER** key.
 - b. If the **PULSE GEN** button stays lit, this indicates that the data timing generator is not yet in the Data Generator mode. In this case, push the **PULSE GEN** button to enter the Data Generator mode.

Creating a Block

A block is a container for the pattern data to be output. Do the following steps to create a block.

1. Push the **MENU** button, select **Settings** using the arrow keys, select **Blocks** using the arrow keys, and then press the **ENTER** key to open the Blocks window.

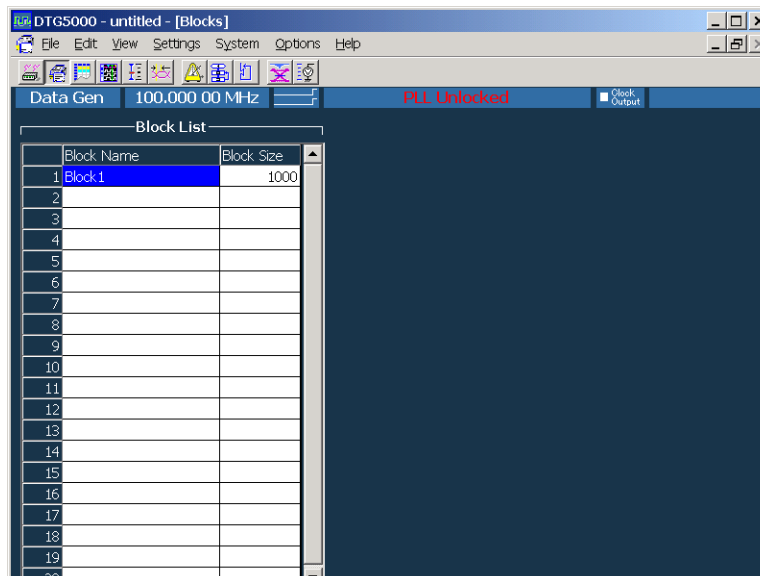

Figure 4-6: Blocks window

Group List. The default group names appear in the Group List represent the maximum number of logical channels which can be used with the mainframe. The logical channels are grouped by eight channels per one group.

The Group lists the grouped logical channels.

The CH lists the physical channels assigned to the logical channels, in the format of “mainframe number - slot name and channel number”, such as **1-A1**.

The installed physical channels are displayed in the right window pane of display area. Any channel indicated by a bullet in a white rectangle has already been assigned to a logical channel.

The logical channels can be created up to 32 channels for the DTG5078, and 8 channels for the DTG5274, and they are independent of the installed output modules.

Now, proceed to grouping and channel assignment.

2. Press the **TAB** key repeatedly. Group List and Channels are activated alternately. Activate the Group List.
3. In the Group List, you can move the cursor using the arrow keys. Move the cursor to the Group column.
4. Resize Group1.
 - a. Push the **SELECT** button, select **Rename/Resize Group...** from the pop-up menu using the arrow keys, and then push the **SELECT** button.
 - b. The Grouping dialog box appears.

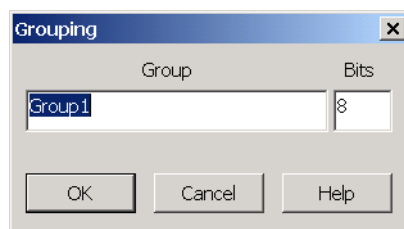

- c. Press the **TAB** key to move the cursor to **Bits**, use the numeric key to enter **4**, and then press the **ENTER** key. The Group1 size changes to 4.
5. Create a group named Group2 that has four logical channels (Bits).
 - a. Push the **SELECT** button, select **New Group...** using the arrow keys, and then push the **SELECT** button.
 - b. The Grouping dialog box appears.

- c. To enter the group name, press the **ALPHA** key to enter the character input mode.
 - d. Press the numeric key **4** four times to enter **G**, press **1** three times to enter **r**, press **6** three times to enter **o**, press **2** twice to enter **u**, and then press **1** once to enter **p**.
 - e. Press the **ALPHA** key to exit the character input mode.
 - f. Press the numeric key **2** to enter **2**. Input of Group2 is complete.
 - g. Press the **TAB** key to activate **Bits**.
 - h. Press the numeric key **4**, and then press the **ENTER** key. The Grouping dialog box disappears. A new Group2 of four channels is created.
6. Assign the Slot A physical channels to Group2.
 - a. Using the arrow keys, move the cursor to **Group2:03**. Press the **TAB** key to activate **Channels**.
 - b. Move the cursor to Slot A Channel 1 using arrow keys.
 - c. Press the **ENTER** key. A white circle is added to the Channel 1 box. In the Group List at the left, physical channel 1-A1 is displayed at CH of Group2:03, and the cursor automatically moved to Group2:02.
 - d. Press the Right arrow key to move the cursor to Channel 2. Press the **ENTER** key. Slot A Channel 2 is assigned to Group2:02.
 - e. Assign Channels 3 and 4 of Slot A to Group2:01 and Group2:00, respectively, in the same way.
 7. Execute grouping.

For details on grouping, refer to *Grouping and Channel Assignment* on page 3-5.

 - a. Activate the Group List using the **TAB** key.
 - b. Push the **SELECT** button, and then select the groupings under **Preset** using the arrow keys. Confirm what type of grouping options are provided in the **Preset** menu.
 - c. Select **8 Channels per Group**. A confirmation dialog box appears. Select **OK**, and then proceed to the next step.
 8. Delete the unnecessary groups.
 - a. Move the cursor to Group4 in the Group list.
 - b. Push the **SELECT** button, select **Delete Group** using the Up and/or Down arrow key, and then push the **SELECT** button.

- c. A dialog box appears to prompt you for confirmation. Select **OK**, and then press the **ENTER** key.
 - d. Delete Group3 in the same way.
- 9. Resize Group1 and Group2.
 - a. Push the **SELECT** button, select **Rename/Resize Group** using the Up and/or Down arrow keys, and then push the **SELECT** button.
 - b. The Grouping dialog box appears.
 - c. Press the **TAB** key to move the cursor to **Bits**, press the numeric key **4**. Then press the **ENTER** key. The Group2 size changes to **4**.
 - d. Using the Up arrow key, move the cursor to Group1. Change the Group1 size to 4 in the same way.
- 10. The **Auto Assign** function is provided to perform the channel assignment quickly.
 - a. Push the **SELECT** button, select **Auto Assign** using the Up and/or Down arrow keys, and then push the **SELECT** button.
 - b. A confirmation dialog appears. Select **OK**. The physical channels are assigned in order, beginning with the top logical channel in the Group List.

This ends grouping and channel assignment.

Creating a Pattern Data

Next, create and edit a pattern data. Creating and editing a pattern data is to define the values included in a block. To edit the data, you can use the Data-Listing and/or Data-Waveform window. The two windows process the same data for the target block and the same results are produced. The differences between the two windows are data display format and edit method. The Data-Listing window is mainly used in this tutorial.

1. Push the front panel **DATA** button. Alternatively, push the **MENU** button, and select **Data-Listing** from the **Settings** menu. The Data-Listing window appears. Pushing the **DATA** button repeatedly toggles between the Data-Listing and Data-Waveform windows alternately.

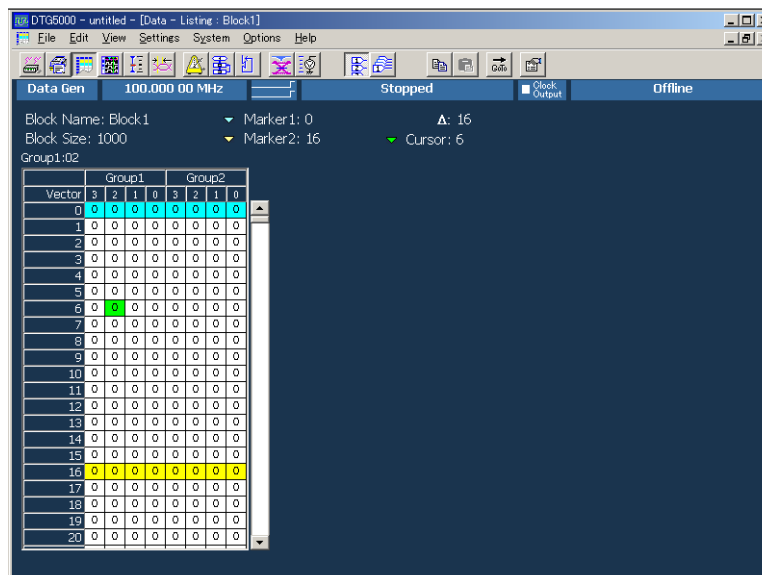
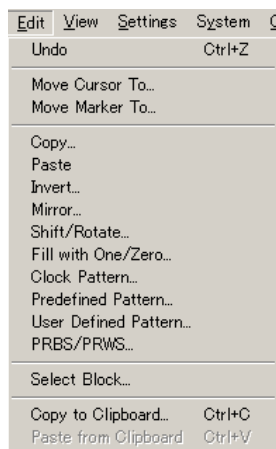

Figure 4-8: Data-Listing window

Edit the pattern data using the cursor and two markers.

2. Push the **MENU** button, select **Edit** using the arrow keys. This opens the **Edit** menu, which contains edit commands.
3. Open the **View** menu using the Right arrow key.



Edit menu

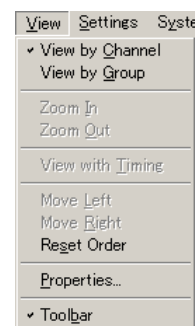

View menu

Figure 4-9: Edit menu and View menu

Using the Cursor and Market

The cursor is used to specify the focused cell. You can use the marker to define the range to be edited.

To move the cursor, you can use the arrow keys, the knob, or the **Move Cursor To...** command in the **Edit** menu. To move to a cell considerably apart from the current position, you can quickly move using the menu. In the menu, you can define the marker position or any vector position.

1. Push the **SELECT** button to open the menu.
2. Select **Move Cursor To...** using the Down arrow key, and then push the **SELECT** button.
3. Select the **Vector** numeric box using the arrow keys and the **TAB** key, then enter the numeric value.
4. Press the **ENTER** key to move the cursor to the vector position you defined.

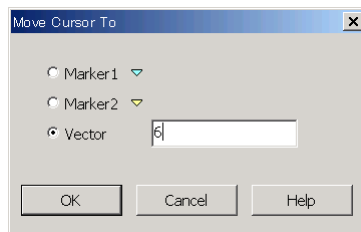

While holding down the **SHIFT** key, you can define a rectangular area by pressing the arrow keys. You are not allowed to define a rectangular area over two or more groups.

To move a marker, you can use **Move Marker To...** in the **Edit** menu.

5. Push the **SELECT** button, select **Move Marker To...**, and then push the **SELECT** button.

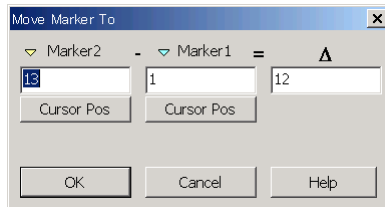

6. Select either the Marker1 or Marker2 numeric box using the **TAB** key and arrow keys, then enter a numeric value. By setting the delta value, you can define the position of Marker2 relative to Marker1. Press the **ENTER** key to move the Marker to the vector position you defined.

7. If you select **Cursor Pos** and press the **ENTER** key, the values of cursor position are input to the numeric box.
8. Use the **TAB** key to activate the **OK** button, and then press the **ENTER** key. The marker moves to the cursor position.

Viewing a Data

Both the Data-Listing and Data-Waveform windows allow you to select a view of data by the channel or by the group.

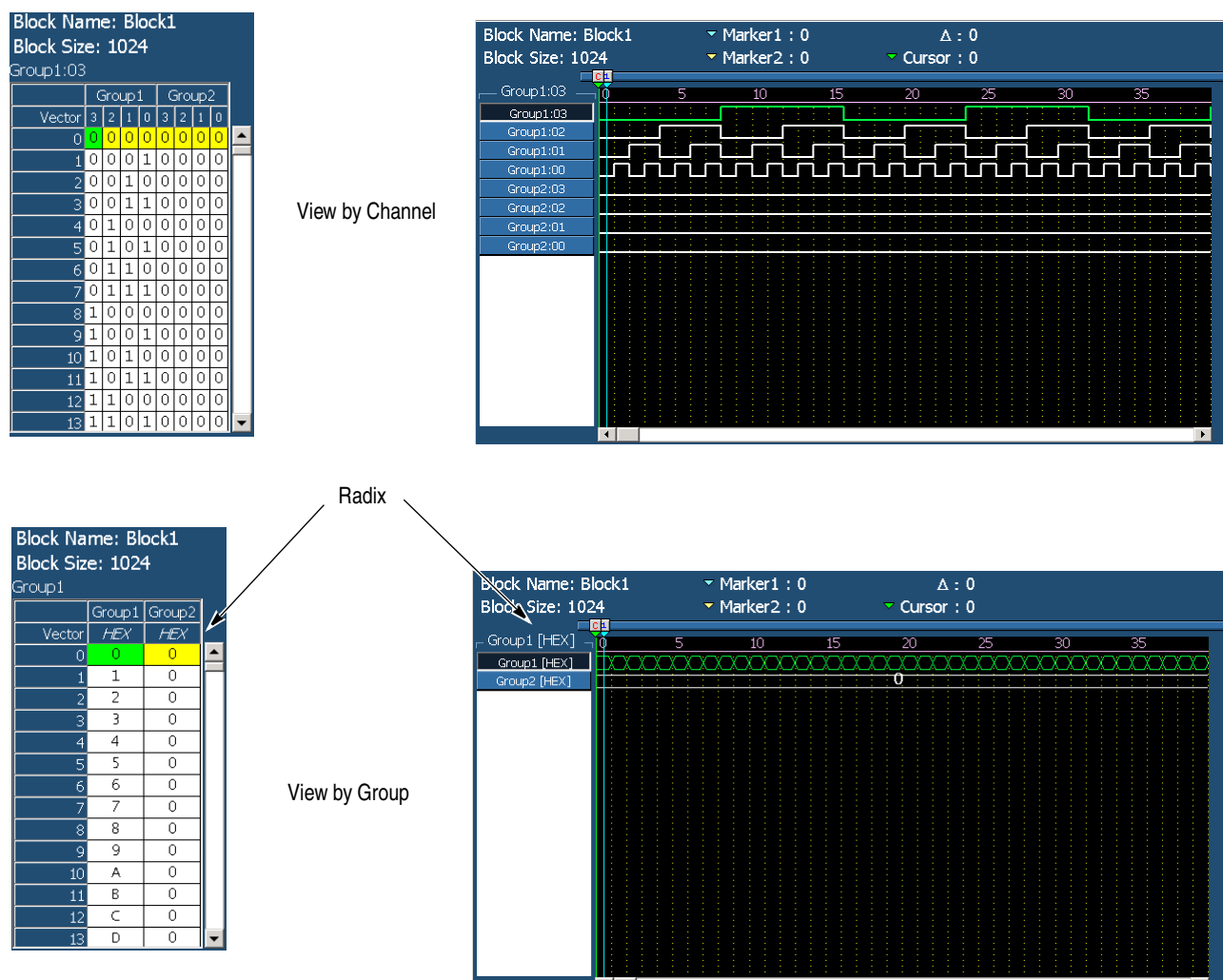
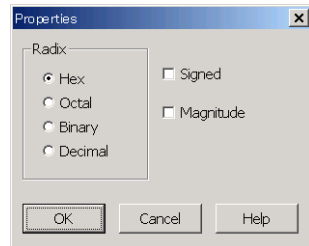

Figure 4-10: View by Channel and View by Group

1. Push the **MENU** button, then open the **View** menu using the arrow keys.
2. If you select **View by Channel**, the data is listed by the channel. If you select **View by Group**, the data is listed by the group.

In addition, in the Data-Listing and Data-Waveform windows, you can select Radix for the data view for one vector by group when the data is shown by the group.

3. Push the **MENU** button, select **Properties...** from the **View** menu, and then push the **SELECT** button.



4. Activate Radix using the **TAB** key. Select Radix using the arrow keys. If you select the **Signed** check box when displaying the Decimal view, you can specify the MSB bit to be used for the sign bit.
5. If you select the **Magnitude** check box, the data view by the group will be magnified in the bitwise direction in the Data-Waveform window.

Edit Commands

The edit commands are listed in the **Edit** menu, which you can open using either the **MENU** or **SELECT** button.

Edit Range. For all the commands except **Paste**, you need to define the rectangular area to be edited.

Specify one of the following for the bitwise direction:

- Only a channel indicated by the cursor (Channel)
- A Group indicated by cursor (Group)
- Consecutive channels specified with the cursor (Selected)

Specify one of the following for the vector direction:

- All the channels in the vector direction (All)
- Channels between two markers (Between Markers)
- Channels between consecutive vectors specified with the cursor (Selected)

To specify the area, use the radio buttons located in **Range** and **By** in the dialog box associated with the selected command. If you have specified View by Group, the bitwise direction is fixed to Group (group indicated by the cursor).

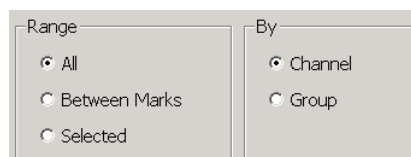

Edit Operations Create the pattern data by using the edit commands.

1. Push the front panel **DATA** button to open the Data-Listing window.
2. Do the following unless you already have entered the View by Channel mode:
 - a. Push the **MENU** button, then open the **View** menu using the arrow keys.
 - b. Select **View by Channel**, then push the **SELECT** button to enter the View by Channel mode.
3. If there is **1** in the data, do the following to make all the data **0** (zero). If there is no data **1**, proceed to step **4**.
 - a. Move the cursor to any position in Group1.
 - b. Push the **SELECT** button, select **Fill with One/Zero...** using the Up and/or Down arrow keys, and then push the **SELECT** button to display the Fill with One/Zero dialog box.

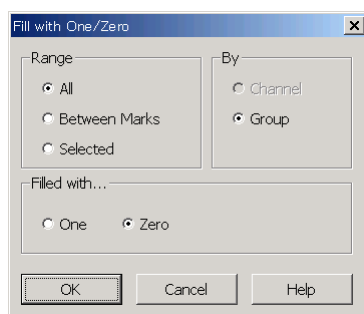

- c. Move the focus to **Range** using the **TAB** key, and select **All**.
- d. Move the focus to **By** using the **TAB** key, and select **Group**.
- e. Move the focus to **Filled with...** using the **TAB** key, and select **Zero**.
- f. Push the **SELECT** button or **ENTER** key. All data in Group1 is changed to **0**.
- g. Move the cursor to any position in Group2. Repeat the same steps from **3-b** through **3-f** to clear all data in Group2 to 0 in the same way.

4. Enter a value in the cell. If you are not in the View by Group mode, or Radix is not Hex, do the following:
 - a. Push the **MENU** button, select **View by Group** from the **View** menu, and then push the **SELECT** button. The data is listed by the group.
 - b. Push the **MENU** button, select **Properties...** from the **View** menu, and then push the **SELECT** button. The Properties dialog box appears.
 - c. Select the **Hex** of Radix using the **TAB** key and arrow keys. Push the **SELECT** button.
5. Move the cursor to Vector 1 in Group1. Press the numeric key **1**.
6. Press the Down arrow key. Press the numeric key **2** to enter **2** in Vector 2.
7. In the same way, enter values **3** to **9** in Vector 3 to Vector 9 in order by using the Down arrow and numeric keys.
8. Move the cursor to Vector 10.
9. If Radix is Hex, you can enter characters A to F by using keys such as **.**, **-**, and **k/m**, regardless of whether you press the **SHIFT** key. Press the numeric key. and then press the Down arrow key to enter **A**.
10. Press the numeric key **-**, then press the Down arrow key to enter **B**.
11. In the same way, enter **C** to **F** in Vector 12 to Vector 15 in order using the unit keys.

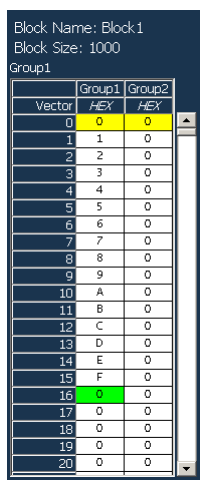

Block Name: Block1
Block Size: 1000
Group1

	Group1	Group2
Vector	HEX	HEX
0	0	0
1	1	0
2	2	0
3	3	0
4	4	0
5	5	0
6	6	0
7	7	0
8	8	0
9	9	0
10	A	0
11	B	0
12	C	0
13	D	0
14	E	0
15	F	0
16	0	0
17	0	0
18	0	0
19	0	0
20	0	0

12. Review the values you have just entered in the Data-Waveform window.
 - a. Push the **DATA** button to open the Data-Waveform window.

- b. Push the **MENU** button, select **Properties...** from the **View** menu, and then push the **SELECT** button. The Properties dialog box appears.
- c. Activate **Magnitude** using the **TAB** key. Add the check mark to Magnitude using the **SPACE** key.
- d. Push the **SELECT** button to display the up counter value you entered.

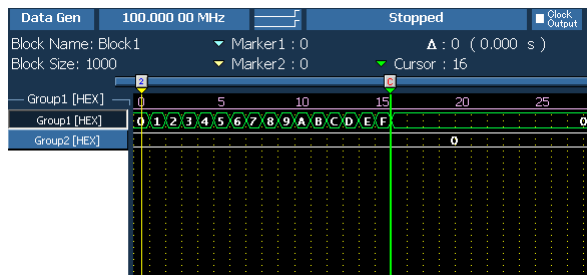

Normal view

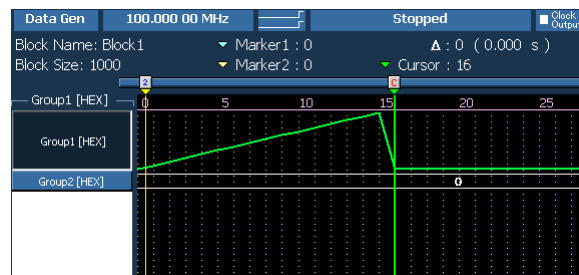

Magnified view

13. Push the **DATA** button to return to the Data-Listing window.
14. Next define the range using markers.
 - a. Push the **SELECT** button, select **Move Marker To...**, and then push the **SELECT** button. The Move Marker To dialog box appears.
 - b. Activate **Marker2** using the **TAB** key, and enter **31** using numeric keys.
 - c. Activate **Marker1** using the **TAB** key, and enter **16** using numeric keys.
 - d. Use the **TAB** key to activate the **OK** button, then press the **ENTER** key.
 - e. Marker1 is now set in the Vector 16 position, and Marker2 in the Vector 31 position.
15. Set the down counter value between the markers.
 - a. Push the **SELECT** button, select **Predefined Pattern...**, and then push the **SELECT** button. The Predefined Pattern dialog box appears.
 - b. Activate **Range** using the **TAB** key.
 - c. Select **Between Markers** using the arrow keys.
 - d. Activate **Pattern** using the **TAB** key, then select **Binary Counter**.
 - e. Activate **Direction** using the **TAB** key, then select **Down**.
 - f. Use the **TAB** key to activate the **OK** button, then press the **ENTER** key.

16. Create the same pattern in the remaining part by **Copy** and **Paste** functions.
 - a. Move the cursor to Vector 0 using the Up arrow key.
 - b. While holding down the **SHIFT** key, press the Down arrow key to move the cursor to Vector 31. Hold down the **SHIFT** key, shifts the cursor to define an area.
 - c. Select **Copy...** using the **SELECT** button. The **Copy** dialog box appears.
 - d. If you have defined an area using the cursor, **Selected** is specified for **Range**.
 - e. Confirm that the **OK** button is active, and press the **ENTER** key.
 - f. Move the cursor to Vector 32 using the Down arrow key.
 - g. Push the **SELECT** button, and then select **Paste** using the arrow keys.
 - h. Once you push the **SELECT** button, the data is pasted immediately.

The **Paste** function only pastes the content of the paste buffer from the cursor position. To duplicate the same pattern repeatedly in the remaining part, you have to repeat paste operations. However, you can duplicate such patterns more easily by using the **User Defined Pattern**.

17. Push the **SELECT** button, select **User Defined Pattern...**, and then push the **SELECT** button. The User Defined Pattern dialog box appears.
 - a. Activate **Range** using the **TAB** key.
 - b. Select **All** using the arrow keys (already selected by default).
 - c. Move the cursor to **Data** using the **TAB** key.
 - d. To enter **0** to **9** from Data1 to Data10.
 - e. For Data11 to Data16, enter **A** to **F**.
 - f. For Data17 to Data32, enter **F** to **0**.
 - g. Press the **TAB** key to activate **OK**, then press the **ENTER** key.
18. Create data for Group2.
 - a. Move the cursor to any of the Group2 vectors.
 - b. Push the **SELECT** button, select **Clock Pattern...**, and then push the **SELECT** button. The Clock Pattern dialog box appears.
 - c. Press the **ENTER** key.

Block Name: Block1
Block Size: 1000
Group2

Vector	Group1 HEX	Group2 HEX
0	0	0
1	1	F
2	2	0
3	3	F
4	4	0
5	5	F
6	6	0
7	7	F
8	8	0
9	9	F
10	A	0
11	B	F
12	C	0
13	D	F
14	E	0
15	F	F
16	0	0
17	0	F
18	0	0
19	0	F
20	0	0

The data creation for Group1 and Group2 has been completed. Before proceeding to the next step, save the data you have just created.

19. Push the **MENU** button, select **Save Setup As...** from the **File** menu, and then press the **ENTER** key.
20. The Save Setup dialog box appears. You can save the setup file using this dialog box. Save the setup file under the name of Tutorial2. See *Saving a Setup File* on page 4-12.

This completes the pattern data creation.

Setting up Output parameters

Use the pattern data you have just created for setting the output parameters such as level, clock frequency or pulse width.

Performing Signal Output. To set the output level in the Level window, you can use the same procedure as the Pulse Generator mode.

To output the pattern in the Data Generator mode, do the following steps:

1. Push the **LEVEL** button to open the Level window. You can operate the Level window in the same way as the Pulse Generator mode.
2. Verify that the High and Low levels are 1.000 V and 0.000 V, respectively. Push the **ALL OUTPUTS ON/OFF** button to turn on the output of all the channels.
3. Push the **RUN** button. The data is loaded into the pattern memory, and then the output begins.

Timing Window Operations

You need to familiarize the specific settings of the Timing window in the Data Generator mode.

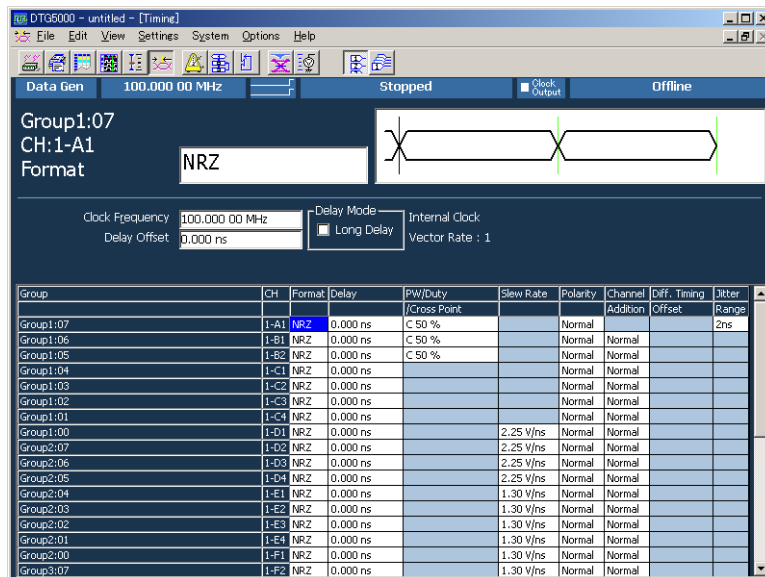

Figure 4-11: Timing window

Changing a Clock Frequency. Do the following to change the clock frequency:

1. Push the **TIMING** button to open the Timing window.
2. Activate the **Clock Frequency** using the **TAB** key.
3. Use the knob and the Digit Select keys to change the **Clock Frequency** setting to 750.00000 MHz.
4. Press the **TAB** key to activate the channel table.

Changing a Format. Do the following to change the format:

1. Use the arrow keys to move the cursor to **Format** for Group2:03 channel.
2. Push the **SELECT** button, select **RZ** from the **View** menu, and then push the **SELECT** button.

If you set the Format to RZ or R1, you can set Pulse Width, Duty, and Cross Point. The **Cross Point Adjustment** is available only in the following condition.

- The DTGM30, DTGM30 or DTGM32 output module is used.
- The output module is installed in slot A, B, C or D.
- The Format is set to NRZ.

If **RZ** or **R1** is specified in any of the channel Format, the maximum Clock Frequency is restricted to 1.675 GHz for the DTG5334, 1.35 GHz for the DTG5274 and 375 MHz for the DTG5078. These values are half of the NRZ Format.

3. Push the **SELECT** button, select **Apply to Channels in the Same Group**, and then push the **SELECT** button.

You can specify the single **Format** to all the channels within the same group by using the **Apply to Channels in the Same Group** command.

Changing a Pulse Width. To change the pulse width, do the following steps.

1. Using the arrow keys, move the cursor to the **PW/Duty/Cross Point** for Group2:03. The **D 50.0%** is displayed in the column. This indicates that the pulse width is set and displayed with **Duty**.
2. Change the value to **75.0%** using the knob.
3. Move the cursor to the **PW/Duty/Cross Point** for Group2:02 using the Down arrow key.
4. Select **Pulse Width** using the **SELECT** button and the arrow keys, and then push the **SELECT** button. This channel has been set and the pulse width is displayed in the **Pulse Width** box.
5. Move the cursor to the **PW/Duty/Cross Point** for Group2:01 using Down arrow key. Select **Trail Delay** using the **SELECT** button and the keys, and then push the **SELECT** button. This channel has been set and the pulse width is displayed with the timing at the falling edge.
6. Set the value to 0.002500 ms using the knob.

Changing Delay. To change the Delay, do the following steps:

1. Move the cursor to **Delay** for Group2:00 using the arrow keys.
2. Use the knob and the Digit Select keys to set **Lead Delay** to 5.000 ns. You can change it between 0 ns and 5.000 ns range.
3. Activate **Delay Offset** using the **TAB** key.
4. Change the Delay Offset value by turning the knob between 0 ns and 5.000 ns range. Change the Delay Offset value to 2.500 ns.

Once the Delay Offset changes, the Delay value of Group2:00 also changes correspondingly. If you do not use the Long Delay function, the total amount of Delay is 5.000 ns.

5. Activate the **Delay** for Group2:00 using the **TAB** key. You can change the Delay value with the knob.

Since you have set the Delay Offset to 2.5 ns, you can change the Delay for the Group2:00 in the -2.500 ns to 2.500 ns range. For any of the other channels, you can set the amount of Delay within this range. Setting the Delay Offset allows you to set a negative amount of Delay for each channel.

Activates Long Delay. If the Delay Mode is set to normal, you can set the total amount of Delay up to 5.000 ns. To set larger amount of Delay, use the **Long Delay** function.

1. Activate the **Long Delay** using the **TAB** key, then press the **SPACE** key to select the check box.
2. Activate the **Delay** for Group2:00 using the **TAB** key.
3. Change the **Delay** value using the knob.

Activating the **Long Delay** function allows you to set a larger amount of Delay. If Clock Frequency is set to 100 MHz, you can set the Delay up to 480.000 ns.

4. Using the **TAB** and **SPACE** keys, turn the Long Delay check box off.

Using the Channel Addition Function. The channel addition function allows you to output the result of logical operation between the signals of adjacent physical channels. For odd numbered channels, this function obtains the result of XOR with the signal of the adjacent even numbered channel. For even numbered channels, this function obtains the result of AND with the signal of the adjacent odd numbered channel. You can use this function for the output modules installed in slot A through D.

1. Use the arrow keys to move the cursor to **Channel Addition** for Group1:01.
2. Push the **SELECT** button to open the pop-up menu. You can select either **Normal** or **XOR** because an odd numbered channel (A3Ch) has been assigned to the physical channel. Select **XOR**, then push the **SELECT** button.
3. Move the cursor to **Channel Addition** for Group1:00.
4. Push the **SELECT** button to open the menu. You can select either **Normal** or **AND** because an even numbered channel (A4ch) has been assigned to the physical channel. Select **AND**, then push the **SELECT** button.

The A3Ch outputs the pattern obtained by XORing the Group1:01 and Group1:00 channels. The A4Ch outputs the pattern obtained by ANDing the Group1:01 and Group1:00 channels.

5. Move the cursor to the cell where **Channel Addition** has been set to **Normal**, and then push the **SELECT** button.
6. Select **Apply to All Channel**, and then push the **SELECT** button. The settings for all the channels return to **Normal**.

7. Push the **RUN** button to stop the output. Push the **ALL OUTPUTS ON/OFF** button to turn off the Output switch.

This ends Tutorial 2.

Tutorial 3: Creating a Sequence

The sequence operation is a function that outputs a complicated pattern by combining the block sequence, the number of repetitions, a jump, Goto, and so on with several blocks and subsequences. In this tutorial, you create several sets of block data and subsequences to create a sequence by combining them.

In Tutorial 3, you create the following sequence, which uses the data timing generator sequence function.

	Label	Wait	Block/ Sub-sequence	Repeat	Event Jump To	Go To
1	Start	On	BinaryUp	40000		
2			Johnson	60000	Graycode	
3			SubBinary	Inf.	Start	
4	Graycode		Graycode	40000	End	
5			SubWalking	600	End	Graycode
6	End		CheckerBoard	20000		
7						
8						

Creating a Block Data

Before starting this tutorial, initialize the data timing generator. Push the **MENU** button, use the arrow keys to select **Default Setup** from the **File** menu, and then press the **ENTER** key.

In this tutorial, use the predefined patterns to create the block patterns.

1. Push the **MENU** button, use the arrow keys to select **Blocks** from the **Settings** menu, and then press the **ENTER** key.
2. The Blocks window appears.
3. The Blocks window contains a predefined block whose name is Block1. The block size is 1000 by default. Follow the steps below to rename Block1:
 - a. With the cursor placed in Block1, press the **ALPHA** key.
 - b. Enter **BinaryUp**, and press the **ENTER** key twice.
 - c. Use the Down arrow key to move the cursor down one line.
 - d. Press the **ALPHA** key to enter the character input mode, and then enter **BinaryDown**.

- e. In the same way, define the blocks named **Johnson**, **Graycode**, **WalkingOnes**, **WalkingZeros**, and **CheckerBoard**, respectively.

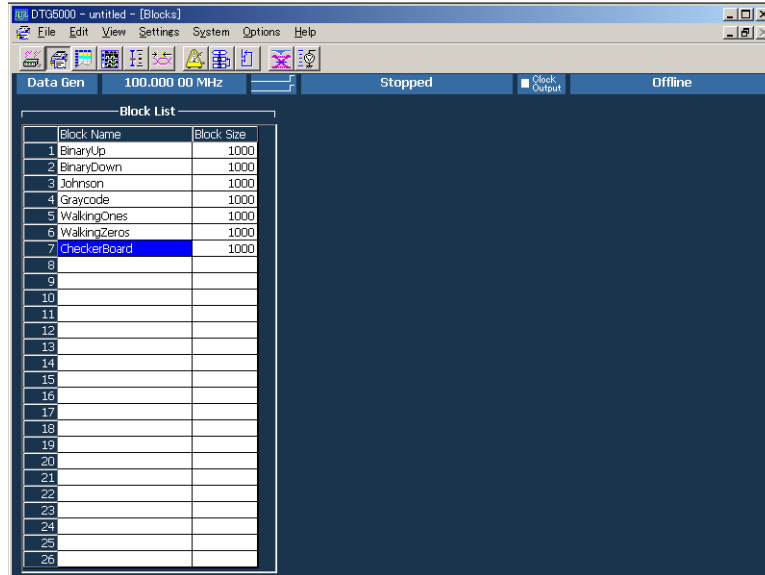

- 4. Push the front panel **DATA** button to open the Data-Listing window.
 - a. Confirm that the **BinaryUp** is displayed in the **BlockName**..

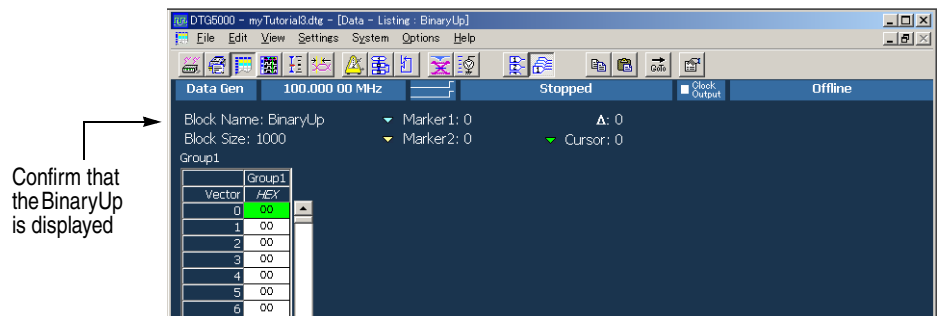

- b. If the **BinaryUp** is not displayed, another block has been selected. If so, push the **SELECT** button, use the arrow keys to select **Select Block...**, and then push the **SELECT** button.
 - c. Select **BinaryUp** using the arrow keys in the Select Block dialog box, and then press the **ENTER** key.
- 5. Push the **SELECT** button, select **Predefined Pattern...** using the arrow keys, and then press the **ENTER** key.
- 6. The Predefined Pattern dialog box appears. Use the **TAB** key and the arrow keys to select **All** for Range, **Group** for By, **Binary Counter** for Pattern, and **Up** for Direction.

7. Press the **ENTER** key to create the binary up counter pattern.
8. Push the **SELECT** button, select **Select Block...**, and then push the **SELECT** button.
9. Select **BinaryDown** using the arrow keys in the Select Block dialog box, and then press the **ENTER** key.
10. Push the **SELECT** button, select **Predefined Pattern...**, and then press the **ENTER** key.
11. The Predefined Pattern dialog box appears. Use the **TAB** key and the arrow keys to select **Down** for Direction.
12. Press the **ENTER** key to create the binary down counter pattern.
13. In the same way, create the patterns in the **Johnson**, **Graycode**, **Walking Ones**, **WalkingZeros**, and **CheckerBoard** blocks under the same names as the predefined patterns.

Creating a Subsequence

Next, create the subsequences using the blocks you have created. The subsequences are recalled from the main sequence. Define the two subsequences named SubBinary and SubWalking. See Figure 4-12.

Sub-sequence List		SubBinary	
1	SubBinary	Block	Repeat
2		1	BinaryUp 10
3		2	BinaryDown 10
4		3	
5		4	
6		5	

Sub-sequence List		SubWalking	
1	SubBinary	Block	Repeat
2	SubWalking	1	WalkingOnes 10
3		2	WalkingZeros 10
4		3	
5		4	
6		5	
7		6	

Figure 4-12: SubBinary and SubWalking subsequences

The SubBinary operates as follows:

- Line 1. Outputs block BinaryUp 10 times before proceeding to the next line.
- Line 2. Outputs block BinaryDown 10 times before exiting this subsequence.

The SubWalking operates as follows:

- Line 1. Outputs block WalkingOnes 10 times before proceeding to the next line.
 - Line 2. Outputs block WalkingZeros 10 times before exiting this subsequence.
1. Push the **MENU** button, select **Subsequence** from the **Settings** menu, and then push the **SELECT** button.
 2. On the first line of subsequence, enter **SubBinary** as the subsequence name. To input the characters, press the **ALPHA** key to change the character input mode.
 3. Activate the table at the right using the **TAB** key. Use this table to define the content of **SubBinary**.
 4. With the cursor placed on the first line in Block1, push the **SELECT** button. The predefined block name list is displayed under the menu items, select **BinaryUp**, and then push the **SELECT** button.
 5. Move the cursor to **Repeat** using the arrow keys, use the numeric key to enter **10** for the number of repetition, and then press the **ENTER** key.
 6. On the second line in Block, set **BinaryDown** for the block name and **10** for the Repeat count.
 7. Move the cursor to the second line in Sub-sequence using the **TAB** key and arrow key.
 8. Enter **SubWalking** as the subsequence name.
 9. Activate the table at the right using the **TAB** key, and then move the cursor to the first line in Block using the arrow keys.
 10. Repeat the same steps as SubBinary to set the **WalkingOnes** for Block name and **10** for repeat count on the first line, **WalkingZeros** for Block name and **10** for repeat count on the second line.

Creating a Main Sequence

Next, create the main sequence as summarized in Table 4-1. The subsequences allow you to set only the number of repetitions of the block. The main sequence allows you to set the number of repetitions, the trigger queue, and jumps. This sequence operates as follows:

- Line 1. Waits for a trigger event. After the event occurs, the system outputs the block **BinaryUp** 40000 times, and then proceeds to the next line.
- Line 2. Repeats the block **Johnson** 60000 times, and proceeds to the next line. If an event occurs during the output, a jump occurs to the line labeled **Graycode**.
- Line 3. Repeats the subsequence **SubBinary** infinitely. If an event occurs during the output, a jump occurs to the line labeled **Start**.
- Line 4. Repeats the block **Graycode** 40000 times, and proceeds to the next line. If an event occurs during the output, a jump occurs to the line labeled **End**.
- Line 5. Repeats the subsequence **SubWalking** 600 times, and jumps to the line labeled **Graycode**. If an event occurs during the output, a jump occurs to the line labeled **End**.
- Line 6. Repeats the block **Checkerboard** 20000 times, and exits the sequence.

Table 4-1: Main sequence

Line	Label	Wait Trig.	Blocks/ Sub-sequenc e	Repeat	Event Jump To	Go To
1	Start	On	BinaryUp	40000		
2			Johnson	60000	Graycode	
3			SubBinary	Inf.	Start	
4	Graycode		Graycode	40000	End	
5			SubWalking	600	End	Graycode
6	End		CheckerBoard	20000		

To create the main sequence, do the following steps:

1. Push the **MENU** button, select **Sequence** from the **Settings** menu, and then push the **SELECT** button.
2. Move the cursor to **Label** of Line 1, press the **ALPHA** key to enter the character input mode. Enter **Start** to the Label cell of Line 1, and then press the **ENTER** key twice.
3. Use the Right arrow key to move the cursor to **WaitTrig**. Press the **SPACE** key to enter **On**.

4. Use the Right arrow key to move the cursor to **Block/Sub-sequence**, push the **SELECT** button, select **BinaryUp** from the pop-up menu, and then push the **SELECT** button. The block name **BinaryUp** is entered.
5. Use the Right arrow key to move the cursor to **Repeat**. Enter **40000** using numeric keys.
6. Use the arrow keys to move the cursor to **Block/Sub-sequence** on Line 2.
7. By repeating the same steps as described above, enter the sequence parameters from the second through sixth lines listed in Table 4-1. To enter **Inf.** (Infinite repeat count), push the **SELECT** button and then select **Infinite** from the pop-up menu.
8. For Sequencer Mode, Jump Mode, and Jump Timing, use the default settings. Make sure that Sequencer Mode is set to **Hardware**, Jump Mode is set to **Event**, and Jump Timing is set to **Async**.

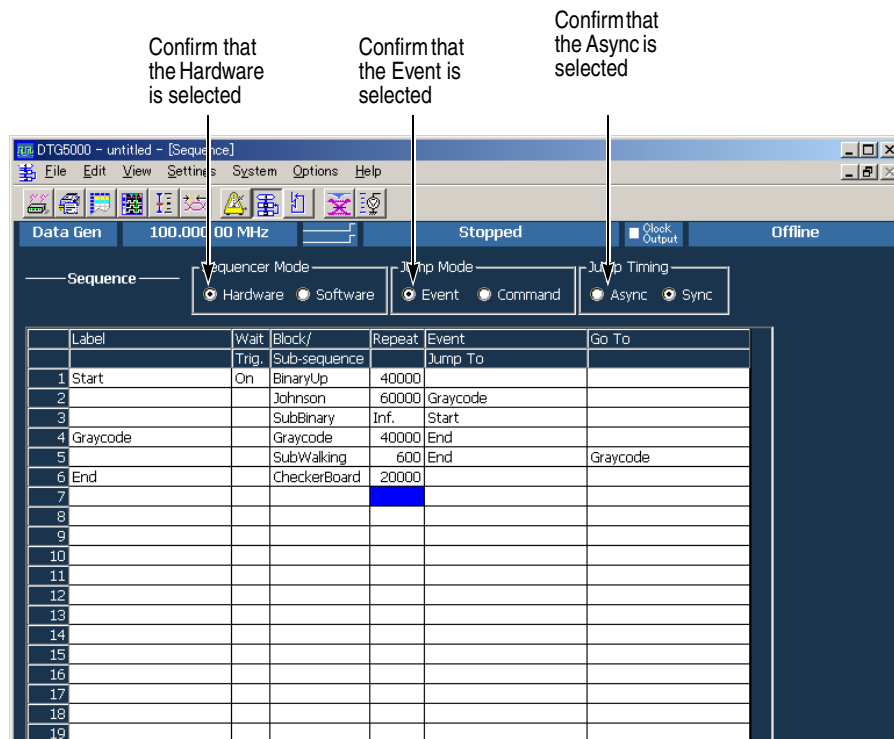

Figure 4-13: Main sequence

Executing a Sequence

In this tutorial, you have created a sequence by combining several blocks and subsequences. The flow of created sequence is shown in Figure 4-14.

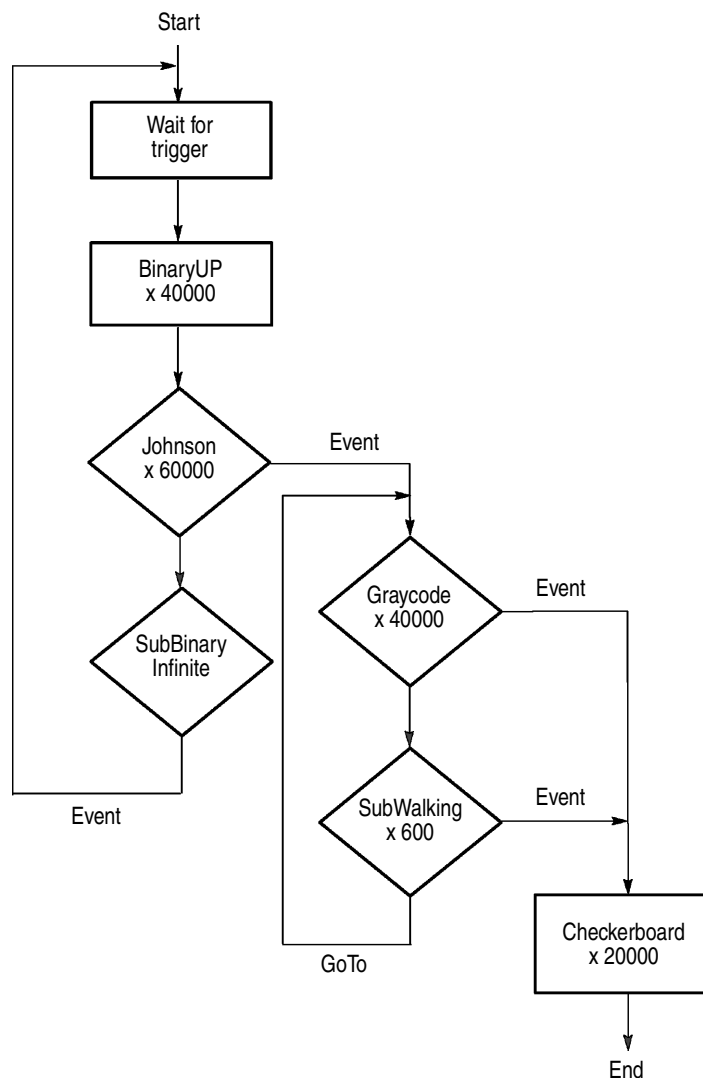

Figure 4-14: Flowchart

The pattern data you output in Tutorial 2 is also a sequence that outputs a single block infinitely. The output sequence is therefore the same as usual pattern output.

In this section, you use the **MANUAL TRIGGER** and **MANUAL EVENT** buttons on the front panel to generate a trigger and an event.

For grouping and channel assignment, use the default settings. For the Level window settings, also use the default settings.

Do the following steps to output the sequence you created:

1. Push the **ALL OUTPUTS ON/OFF** button to turn on the relay of the output channel.
2. Push the **RUN** button. The sequence is loaded and the data is checked. After verifying that the data contains no error, the output begins.
3. The **Wait Trigger** is activated on the first line in the loaded sequence. The output does not begin until a trigger occurs. The **Waiting** appears in the status display field. Once you push the **MANUAL TRIGGER** button, the signal output begins.
4. Wait. The **SubBinary** (third line) will be output repeatedly. If you push the **MANUAL EVENT** button during the output, the output process jumps to the first line.
5. The sequence is waiting for a trigger. Push the **MANUAL TRIGGER** button to start the output.
6. While the block **Johnson** (second line) is being output, push the **MANUAL EVENT** button to jump to the fourth line.
7. The sequence repeats the output of the fourth and fifth lines.
8. While this loop is repeated, if you push the **MANUAL EVENT** button, the output process jumps to the **End** line, then the block **CheckerBoard** is output, and finally exits the sequence. A message **Stopped** is displayed in the status display field.
9. If you want to stop the output while the output is being performed, push the **RUN** button. If the **RUN** button LED is not lit, this indicates that the output is off.
10. Once the output finishes, push the **ALL OUTPUTS ON/OFF** button to turn off the relay of the output connector.

This completes Tutorial 3.



Index

Index

Numbers

10 MHz REF OUT, 2-13
rear panel connector, 2-13

A

Accessories, 1-19
 Optional, 1-22
 optional, 1-22
 Standard, 1-21
 standard, 1-21
Activates Long Delay
 Timing window, 4-30
Address
 Tektronix, -xii
ALL OUTPUTS ON/OFF button, 2-5
 tutorial, 4-8
ALPHA key, 2-5
 text input, 2-51
Application Windows, 2-14
Arrow key, 2-4
arrow keys, 4-3
Arrow keys (Up, Down, Left and Right), 2-4
Assigning a Channel, 3-5, 3-9
Auto Assign function, 3-9
 tutorial, 4-18

B

backing up user files, 1-18
BKSP key, 2-5
block, 3-3
Blocks window, 2-22
 Edit Menu, 2-23
 tutorial, 4-14

C

CD-ROM drive, 2-10
 location, 1-11, 2-10
Changing a Clock Frequency
 Timing window, 4-28
Changing a Delay
 Timing window, 4-29
Changing a Format
 Timing window, 4-28
Changing a Pulse Width
 Timing window, 4-29
Channel Addition, 4-30
 Timing window, 2-31
channel assignment, 3-5, 3-9

 tutorial, 4-15
Channel Group window, 2-21
 define a group, 3-6
 Edit menu, 2-21
 tutorial, 4-15
 window operation, 2-48
Channels
 Channel Group window, 2-21
CLK OUT
 Master-Slave Connection, 2-12
 rear panel connector
 , 2-12
CLOCK
 front panel connector, 2-7
 rear panel connector, 2-11
CLOCK EXTERNAL IN, 2-7, 2-11
CLOCK OUT, 2-7, 2-11
Configuration
 mainframe and output module, 1-4
 power consumption constraints, 1-4
 software installation, 1-18
 System, 1-7
connecting peripherals, 1-11
connecting to a network, 1-10
connectors
 front panel, 2-5
Contacting Tektronix, -xii
control box menus, 2-14
creating
 emergency rescue disk, 1-16
Creating a Block
 tutorial, 4-14
Creating a Block Data
 tutorial, 4-31
Creating a Main Sequence
 tutorial, 4-35
Creating a New Group, 3-7
Creating a Pattern Data, 4-18
Creating a Sequence
 tutorial, 4-31
Creating a Subsequence
 tutorial, 4-33
Current consumption coefficient, 1-4
cursor, 4-20

D

DATA button, 2-4
Data Generator Mode
 tutorial, 4-14
Data-Listing window, 2-24
 Edit Menu, 2-25
 tutorial, 4-19
 window operation, 2-46
Data-Waveform window, 2-26
 Edit Menu, 2-26

DC OUTPUT

- front panel connector, 2-8
- DC Output window, 2-39
- De-assigning a Channel, 3-10
- Default Setup
 - File menu, 2-15
- Defining a Group, 3-5
- DEL key, 2-5
- Deleting a Group, 3-8
- Description
 - key features, 1-1
 - Product, 1-1
- Diagnostics
 - System menus, 2-17
- Digit Select arrow key, 2-4
- Digit Select arrow keys, 4-3
- Display Area, 2-14
- DTG5000 Configuration Utility, 1-5
- DTG5000 Software, 1-5
- DTGM31 Dj Adjustment
 - System menus, 2-17

E

Edit menus

- Blocks window, 2-23
 - Channel Group window, 2-21
 - Data-Listing window, 2-25, 2-26
 - DC Output window, 2-40
 - Level window, 2-29
 - Sequence window, 2-35
 - Subsequence window, 2-37
 - Timing window, 2-31
- ### Edit Operations, 4-23
- End Program dialog, 1-15
- ### ENTER key, 2-5
- environment requirements, 1-8
- ### ESC key, 2-4
- ### EVENT IN
- front panel connector, 2-7
- ### Executing a Sequence
- tutorial, 4-37
- ### EXTERNAL 10 MHz REF IN, 2-13
- external monitor, 1-11

F

- File Menu, 2-15
- File Operations, 2-52
- Front Panel, 2-1
- front panel connector
 - CLOCK, 2-7
 - EVENT IN, 2-7
 - SKEW CAL IN, 2-7
 - SYNC OU, 2-7
 - SYNC OUT, 2-7
 - TRIGGER IN, 2-6
- front panel connectors, 2-5

Front panel control

- ALL OUTPUTS ON/OFF button, 2-5
 - ALPHA key, 2-5
 - Arrow key, 2-4
 - BKSP key, 2-5
 - DATA button, 2-4
 - DEL key, 2-5
 - Digit Select arrow key, 2-4
 - ENTER key, 2-5
 - ESC key, 2-4
 - LEVEL button, 2-4
 - MANUAL EVENT button, 2-5
 - MENU button, 2-3
 - PULSE GEN button, 2-5
 - RUN button, 2-4
 - SELECT button, 2-4
 - SHIFT key, 2-5
 - SPACE key, 2-5
 - TAB key, 2-4
 - TIMING button, 2-4
- ### front panel controls, 2-1, 2-2, 2-3
- System menu, 2-17

G

- group, 3-3
- Group List
 - Channel Group window, 2-21, 3-6, 4-16
- grouping
 - data structure, 3-5
 - tutorial, 4-15

H

- Help Menu, 2-18

I

- Installation, 1-7
 - software installation, 1-18
- installing output module, 1-9
- instrument problems
 - system diagnostics, 1-18
- Internal Pattern Data, 3-1
- Introduction
 - to this manual, -x

J

- Jitter Generation window, 2-38
- JUMP IN
 - Master-Slave Connection, 2-12
 - rear panel connector, 2-12
- JUMP OUT

Master-Slave Connection, 2-12
 rear panel connector, 2-12

K

Key Operations, 2-53
 keyboard, 2-55
 Knob, 2-4
 front panel controls, 2-4

L

LAN port, 1-11, 2-10
 language options, 1-20
 LCD Panel Check
 System menus, 2-17
 LEVEL button, 2-4
 Level Calibration
 System menus, 2-17
 Level window, 2-28
 Edit Menu, 2-29
 how to use, 4-6
 logical channel, 3-2

M

Mainframe and Output Module Configuration, 1-4
 MANUAL EVENT button, 2-5
 MANUAL TRIGGER button, 2-5
 Manuals
 part numbers, 1-20
 related, -xi
 marker, 4-20
 Master-Slave
 rear panel connector, 2-12
 Menu Bar, 2-14
 MENU button, 2-3
 menu operations, 2-41
 Menu selection, 2-41, 2-43, 2-45, 2-46, 2-48, 2-49,
 2-50, 2-51, 2-52
 menu system, 2-41
 Monitor, 1-11
 mouse, 2-55
 Move Cursor To...
 dialog box, 4-20
 Move Marker To...
 dialog box, 4-20

N

navigation keys, 2-3
 ESC key, 2-4
 SELECT button, 2-4
 TAB key, 2-4
 Network
 connecting, 1-10

numeric input, 2-50
 using the knob, 2-51

O

Offline mode, 4-1
 On/Standby switch, 1-12
 operating requirements, 1-9
 Optional accessories, 1-22
 Options Menu, 2-17
 Output a Signal
 tutorial, 4-5
 output module
 installing, 1-9

P

Password, 1-13
 peripheral
 connecting, 1-11
 PHASE LOCK
 rear panel connector, 2-13
 PHASE LOCK IN
 rear panel connector, 2-13
 Phone number
 Tektronix, -xii
 physical channel, 3-2
 pop-up menu, 4-6
 Pop-up Menu Items, 2-42
 powering off, 1-14
 powering on, 1-12
 Predefined Level
 Edit Menu
 Level window, 2-29
 Predefined Level dialog box, 4-7
 preset grouping options, 3-8
 principal power switch, 1-12
 Printer, 1-11
 Product
 accessories, 1-19
 Description, 1-1
 software, 1-5
 Product support
 contact information, -xii
 PULSE GEN button, 2-5, 4-4
 Pulse Generator Mode
 tutorial, 4-4

R

Readme file, 1-5
 rear panel connector
 10 MHz REF OUT, 2-13
 CLK IN, 2-12
 CLK OUT, 2-12
 CLOCK, 2-11
 COM, 2-10
 EXTERNAL 10 MHz REF IN, 2-13

- GPIB, 2-10
- JUMP IN, 2-12
- JUMP OU, 2-12
- Keyboard, 2-10
- LAN, 2-10
- PHASE LOCK IN, 2-13
- USB, 2-10
- VGA, 2-10
- Rear Panel Connectors, 2-9
- Related Manuals, -xi
- removing output module, 1-10
- Renaming a group, 3-7
- rescue disk
 - creating, 1-16
- Resizing a group, 3-7
- resolution settings
 - external display, 2-10
- RUN button, 2-4

S

- Saving a Setup File, 4-12
- Screen elements, 2-14
- SELECT button, 2-4
 - pop-up menu, 2-42
- sequence, 3-3
- Sequence window, 2-34
 - Edit Menu, 2-35
 - window operation, 2-49
- Service support
 - contact information, -xii
- Setting up Output Parameters, 4-27
- Setting up Windows 2000, 1-13
- Settings Menu, 2-16
- SHIFT key, 2-5
- Shutting down, 1-14
- site considerations, 1-8
- SKEW CAL IN
 - front panel connector, 2-7
- Skew Calibration
 - System menus, 2-17
- Software
 - upgrade, 1-6
- Software Installation, 1-18
- SPACE key, 2-5
- stacking the mainframes, 1-8
- Standard
 - accessories, 1-21
- Status Ba, 2-20
- Status Bar, 2-14, 2-20
- Subsequence window, 2-36
 - Edit menu, 2-37
- Suffix button, 2-5
- Suffix buttons, 2-5
- SYNC OUT
 - front panel connector, 2-7
- system diagnostics, 1-18
- System Menu, 2-17
- system software, 1-5

T

- TAB key, 2-4
- Technical support
 - contact information, -xii
- Tektronix
 - contacting, -xii
- Text Input, 2-51
- Time Base window, 2-32
 - PG mode, 4-4
 - window operation, 2-42
- TIMING button, 2-4
- Timing window, 2-30
 - Edit menu, 2-31
 - how to use, 4-9
 - tutorial, 4-28
 - window operation, 2-44
- Toolbar, 2-14, 2-18, 2-19
- tutorial
 - Pulse Generator Mode, 4-4

U

- unpacking, 1-7
- Update
 - Software, 1-5
- Upgrade
 - software, 1-6
- URL
 - Tektronix, -xii
- USB
 - front panel connector, 2-8
- USB port
 - rear panel, 1-11, 2-10
- user files
 - backing up, 1-18
- User name, 1-13
- using cursor, 4-20
- using marker, 4-20
- Using the Channel Addition Function, 4-30

V

- View by Channel, 4-21
- View by Group, 4-21
- View Menu, 2-15

W

- Web site address
 - Tektronix, -xii
- Window operation, 2-42
- Windows 2000
 - set up, 1-13
- Windows operation
 - Channel Group, 2-48
 - Data-Listing, Data-Waveform, 2-46

Sequence, 2-49
Time Base Window operation, 2-43
Timing window, 2-44

X

XTERNAL 10 MHz REF IN
rear panel connector, 2-13

