



ABN 43 064 478 842

231 Osborne Avenue Clayton South, VIC 3169
PO Box 1548, Clayton South, VIC 3169
t 03 9265 7400 f 03 9558 0875
freecall 1800 680 680
www.tmgtestequipment.com.au

Test & Measurement

- > sales
- > rentals
- > calibration
- > repair
- > disposal

Complimentary Reference Material

This PDF has been made available as a complimentary service for you to assist in evaluating this model for your testing requirements.

TMG offers a wide range of test equipment solutions, from renting short to long term, buying refurbished and purchasing new. Financing options, such as Financial Rental, and Leasing are also available on application.

TMG will assist if you are unsure whether this model will suit your requirements.

Call TMG if you need to organise repair and/or calibrate your unit.

If you click on the "Click-to-Call" logo below, you can call us for FREE!

TMG Corporate Website

TMG Products Website



Click-to-Call
TMG Now



Product Lifecycle Management System

Disclaimer:

All trademarks appearing within this PDF are trademarks of their respective owners.



User Manual



TDS7000 Series Digital Phosphor Oscilloscopes (TDS7104 & TDS7054)

071-0700-02

This document supports firmware version 1.00
and above.

www.tektronix.com

Copyright © Tektronix, Inc. All rights reserved.

Tektronix products are covered by U.S. and foreign patents, issued and pending. Information in this publication supercedes that in all previously published material. Specifications and price change privileges reserved.

Tektronix, Inc., P.O. Box 500, Beaverton, OR 97077-0001

TEKTRONIX and TEK are registered trademarks of Tektronix, Inc.

TekVISA, FastFrame, and VocalLink are registered trademarks of Tektronix, Inc.

WARRANTY

Tektronix warrants that the products that it manufactures and sells will be free from defects in materials and workmanship for a period of one (1) year from the date of shipment. If this product proves defective during its warranty period, Tektronix, at its option, will either repair the defective product without charge for parts and labor, or provide a replacement in exchange for the defective product.

This warranty applies only to products returned to the designated Tektronix depot or the Tektronix authorized representative from which the product was originally purchased. For products returned to other locations, Customer will be assessed an applicable service charge. The preceding limitation shall not apply within the European Economic Area, where products may be returned for warranty service to the nearest designated service depot regardless of the place of purchase.

In order to obtain service under this warranty, Customer must provide the applicable office of Tektronix or its authorized representative with notice of the defect before the expiration of the warranty period and make suitable arrangements for the performance of service. Customer shall be responsible for packaging and shipping the defective product to the service center designated by Tektronix or its representative, with shipping charges prepaid. Tektronix or its representative shall pay for the return of the product to Customer. Customer shall be responsible for paying any associated taxes or duties.

This warranty shall not apply to any defect, failure or damage caused by improper use or improper or inadequate maintenance and care. Tektronix shall not be obligated to furnish service under this warranty:

- a) to repair damage resulting from attempts by personnel other than Tektronix representatives to install, repair or service the product;
- b) to repair damage resulting from improper use or connection to incompatible equipment;
- c) to repair any damage or malfunction caused by the use of non-Tektronix supplies or consumables;
- d) to repair a product that has been modified or integrated with other products when the effect of such modification or integration increases the time or difficulty of servicing the product; or
- e) to repair damage or malfunction resulting from failure to perform user maintenance and cleaning at the frequency and as prescribed in the user manual (if applicable).

THE ABOVE WARRANTIES ARE GIVEN BY TEKTRONIX WITH RESPECT TO THIS PRODUCT IN LIEU OF ANY OTHER WARRANTIES, EXPRESS OR IMPLIED. TEKTRONIX AND ITS VENDORS DISCLAIM ANY IMPLIED WARRANTIES OF MERCHANTABILITY OR FITNESS FOR A PARTICULAR PURPOSE. TEKTRONIX' RESPONSIBILITY TO REPAIR OR REPLACE DEFECTIVE PRODUCTS IS THE SOLE AND EXCLUSIVE REMEDY PROVIDED TO THE CUSTOMER FOR BREACH OF THIS WARRANTY. TEKTRONIX AND ITS VENDORS WILL NOT BE LIABLE FOR ANY INDIRECT, SPECIAL, INCIDENTAL, OR CONSEQUENTIAL DAMAGES IRRESPECTIVE OF WHETHER TEKTRONIX OR THE VENDOR HAS ADVANCE NOTICE OF THE POSSIBILITY OF SUCH DAMAGES.

Table of Contents

General Safety Summary	xi
To Avoid Fire or Personal Injury	xi
Symbols and Terms	xii
Preface	xiii
About This Manual	xiii
Related Manuals and Online Documents	xiv
Contacting Tektronix	xv

Getting Started

Product Description	1-1
Models	1-1
Key Features	1-1
Product Software	1-2
Firmware Upgrade	1-3
Probes Supported	1-4
Installation	1-5
Unpacking	1-5
Checking the Environment Requirements	1-6
Connecting Peripherals	1-6
Powering On the Oscilloscope	1-8
Shutting Down the Oscilloscope	1-9
Creating an Emergency Startup Disk	1-10
Backing Up User Files	1-10
Installing Software	1-11
Enabling Your LAN and Connecting to a Network	1-14
Setting up a Dual Display	1-14
Incoming Inspection	1-17
Assemble Equipment	1-17
Self Tests	1-17
Functional Tests	1-18
Perform the Extended Diagnostics	1-26
Accessories & Options	1-29
Options	1-29
Accessories	1-30

Operating Basics

Documentation Map	2-2
System Overview Maps	2-3
Functional Model Map	2-3
Process Overview Map	2-5
User Interface Map - Complete Control and Display	2-6
Front Panel Map - Quick Access to Most Often Used Features	2-7
Display Map - Single Graticule	2-8

Front Panel I/O Map	2-9
Rear Panel I/O Map	2-10

Reference

Overview	3-1
Acquiring Waveforms	3-3
Signal Connection and Conditioning	3-4
Connecting and Conditioning Your Signals	3-5
To Set Up Signal Input	3-8
To Autoset the Oscilloscope	3-11
To Reset the Oscilloscope	3-12
To Get More Help	3-13
Input Conditioning Background	3-13
Setting Acquisition Controls	3-21
Using the Acquisition Controls	3-22
To Set Acquisition Modes	3-27
To Start & Stop Acquisition	3-29
Acquisition Control Background	3-32
Acquisition Hardware	3-32
Sampling Process	3-33
Sampling Modes	3-33
Waveform Record	3-34
Real-time Sampling	3-35
Equivalent-time Sampling	3-35
Interpolation	3-37
Interleaving	3-37
Using Fast Acquisition Mode	3-38
Using Fast Acquisitions	3-39
To Turn Fast Acquisitions On and Off	3-42
To Set Display Format	3-45
Using FastFrame	3-46
Using FastFrame Acquisitions	3-47
To Set FastFrame Mode	3-48
Time Stamping Frames	3-49
Triggering	3-53
Triggering Concepts	3-54
The Trigger Event	3-54
Trigger Sources	3-54
Trigger Types	3-55
Trigger Modes	3-55
Trigger Holdoff	3-56
Trigger Coupling	3-57
Horizontal Position	3-57
Slope and Level	3-57
Delayed Trigger System	3-58
Triggering from the Front Panel	3-58
Access Procedures	3-58
To Check Trigger Status	3-62
Additional Trigger Parameters	3-64
Advanced Triggering	3-68

To Trigger on a Glitch	3-73
To Trigger on a Runt Pulse	3-75
Trigger Based on Pulse Width	3-77
To Trigger Based on Transition Time	3-79
Trigger Based on Pulse Timeout	3-82
Trigger on a Pattern	3-84
To Trigger on a State	3-87
To Trigger on Setup/Hold Time Violations	3-88
Sequential Triggering	3-92
Using Sequential Triggering	3-92
To Trigger on a Sequence	3-96
Comm Triggering	3-99
Displaying Waveforms	3-101
Using the Waveform Display	3-102
Using the Display	3-103
To Display Waveforms in the Main Graticule	3-107
Setting Zoom Controls	3-109
Using with Waveforms	3-109
To Zoom Waveforms	3-109
Customizing the Display	3-114
Using Display Controls	3-114
Set Display Styles	3-117
Customize Graticule & Waveforms	3-119
Measuring Waveforms	3-121
Taking Automatic Measurements	3-122
Using Automatic Measurements	3-124
To Take Automatic Measurements	3-127
To Localize a Measurement	3-130
Taking Cursor Measurements	3-132
Using Cursors	3-133
To Set the Cursor Sources	3-136
Taking Histograms	3-138
Using Histograms	3-139
To Start and Reset Histogram Counting	3-140
Histogram Measurements	3-141
Optimizing Measurement Accuracy	3-141
To Compensate the Oscilloscope	3-142
To Connect the Probe Calibration Fixture	3-143
To Calibrate Probes	3-146
To Compensate Passive Probes	3-148
To Deskew Channels	3-148
Serial Mask Testing (Option SM Only)	3-152
Creating and Using Math Waveforms	3-153
Defining Math Waveforms	3-154
Using Math	3-155
To Define a Math Waveform	3-160
Operations on Math Waveforms	3-163
Using Math Waveforms	3-164
To Use Math Waveforms	3-164
Defining Spectral Math Waveforms	3-168

Using Spectral Math Controls	3-169
Recognizing Aliasing	3-190
To Select a Predefined Spectral Math Waveform	3-192
To Define a Spectral Math Waveform	3-193
Data Input/Output	3-205
Saving and Recalling a Setup	3-205
To Save Your Setup	3-208
To Recall Your Setup	3-211
Saving and Recalling Waveforms	3-213
To Save Your Waveform	3-214
To Recall Your Waveform	3-218
To Clear References	3-220
Exporting and Copying Waveforms	3-223
To Export Your Waveform	3-224
To Use an Exported Waveform	3-232
To Copy Your Waveform	3-234
Printing Waveforms	3-238
To Print from Front Panel	3-238
To Print from Menu Bar	3-238
To Set Up the Page	3-238
To Preview the Page	3-240
To Print Using Print Screen	3-241
To Date/Time Stamp Hardcopies	3-242
Remote Communication	3-243
Accessing Online Help	3-245
How to Use Online Help	3-245

Appendices

Appendix A: Specifications	A-1
Product and Feature Description	A-1
Acquisition Features	A-2
Signal Processing Features	A-2
Display Features	A-3
Measurement Features	A-3
Trigger Features	A-3
Convenience Features	A-3
Specification Tables	A-4
Appendix B: Automatic Measurements Supported	B-1
Levels Used in Taking Amplitude, Timing, and Area Measurements	B-4
Levels Used in Taking Eye Measurements (Option SM Only)	B-6
P Values	B-6
T1 Values	B-7
T2 Values	B-7
DCD Values	B-7
Appendix C: Cleaning	C-1
Exterior Cleaning	C-1
Flat Panel Display Cleaning	C-1
Appendix D: Menu Bar Commands	D-1
File Commands	D-1
Edit Commands	D-3

Vertical Commands	D-3
Horizontal and Acquisition Commands	D-4
Trigger Commands	D-5
Display Commands	D-6
Cursors Commands	D-8
Measure Commands	D-9
Masks Commands (Option SM Only)	D-10
Math Commands	D-11
Utilities Commands	D-11
Help Commands	D-12

Glossary

Index

List of Figures

Figure 1-1: Locations of peripheral connectors on rear panel	1-7
Figure 1-2: Line fuse and power cord connector locations, rear panel	1-8
Figure 1-3: On/Standby switch location	1-9
Figure 1-4: Drag area for Windows task bar	1-16
Figure 1-5: Universal test hookup for functional tests - CH 1 shown	1-19
Figure 1-6: Channel button location	1-20
Figure 1-7: Setup for time base test	1-21
Figure 1-8: Setup for trigger test	1-23
Figure 1-9: Setup for the file system test	1-25
Figure 3-1: Input & Acquisition Systems & Controls	3-4
Figure 3-2: Setting vertical range and position of input channels . .	3-16
Figure 3-3: Varying offset moves the vertical acquisition window on the waveform	3-17
Figure 3-4: Horizontal Acquisition window definition	3-18
Figure 3-5: Common trigger, record length, and acquisition rate for all channels	3-20
Figure 3-6: Roll mode	3-26
Figure 3-7: Aliasing	3-27
Figure 3-8: Digitizer configuration	3-33
Figure 3-9: Digital acquisition — sampling and digitizing	3-33
Figure 3-10: The waveform record and its defining parameters . . .	3-34
Figure 3-11: Real-time sampling	3-35
Figure 3-12: Equivalent-time sampling	3-36
Figure 3-13: Normal DSO and Fast Acquisition displays	3-40
Figure 3-14: Normal DSO Acquisition and Display mode versus Fast Acquisition mode	3-41
Figure 3-15: Fast Acquisition XY display	3-45
Figure 3-16: FastFrame	3-46
Figure 3-17: FastFrame time stamp	3-51
Figure 3-18: Triggered versus untriggered displays	3-54
Figure 3-19: Triggered versus untriggered displays	3-56
Figure 3-20: Holdoff adjustment can prevent false triggers	3-57
Figure 3-21: Slope and level controls help define the trigger	3-58

Figure 3-22: Example advanced trigger readout	3-68
Figure 3-23: Violation zones for Setup/Hold triggering	3-72
Figure 3-24: Triggering on a Setup/Hold time violation	3-91
Figure 3-25: Triggering with Horizontal Delay off	3-93
Figure 3-26: Triggering with Horizontal Delay on	3-94
Figure 3-27: Trigger and Horizontal Delay summary	3-95
Figure 3-28: Display elements	3-102
Figure 3-29: Horizontal Position includes time to Horizontal Reference	3-106
Figure 3-30: Graticule, Cursor, and Automatic measurements	3-122
Figure 3-31: Annotated display	3-123
Figure 3-32: High/Low tracking methods	3-125
Figure 3-33: Reference-level calculation methods	3-126
Figure 3-34: Horizontal cursors measure amplitudes	3-133
Figure 3-35: Components determining Time cursor readout values	3-134
Figure 3-36: Horizontal histogram view and measurement data ...	3-138
Figure 3-37: Pass/Fail mask testing	3-152
Figure 3-38: Spectral analysis of an impulse	3-154
Figure 3-39: Functional transformation of an acquired waveform .	3-154
Figure 3-40: Derivative math waveform	3-158
Figure 3-41: Peak-peak amplitude measurement of a derivative waveform	3-159
Figure 3-42: Duration and resolution control effects	3-170
Figure 3-43: Definition of gate parameters	3-171
Figure 3-44: Affects of frequency domain control adjustments	3-173
Figure 3-45: Effects of adjusting the reference level	3-174
Figure 3-46: Effects of adjusting the reference level offset control	3-175
Figure 3-47: Example of the effects of setting the phase suppression threshold	3-177
Figure 3-48: Windowing the time domain record	3-179
Figure 3-49: Example of scallop loss for a Hanning window without zero fill	3-181
Figure 3-50: Time and frequency graphs for the Gaussian window	3-182
Figure 3-51: Time and frequency domain graphs for the Rectangular window	3-183
Figure 3-52: Time and frequency graphs of the Hamming window	3-184

Figure 3-53: Time and frequency graphs for the Hanning window	3-185
Figure 3-54: Time and frequency graphs for the Kaiser-Bessel window	3-186
Figure 3-55: Time and frequency graphs of the Blackman-Harris window	3-187
Figure 3-56: Time and frequency domain graphs for the Flattop2 window	3-188
Figure 3-57: Tek Exponential window in the time and the frequency domains	3-189
Figure 3-58: How aliased frequencies appear in a spectral waveform	3-191
Figure 3-59: Auto-increment file name feature	3-207
Figure 3-60: Print window	3-238
Figure 3-61: Hardcopy formats	3-239
Figure 3-62: Page setup window	3-240
Figure 3-63: Print preview window	3-241
Figure B-1: Levels used to determine measurements	B-5
Figure B-2: Eye-diagram and optical values	B-6

List of Tables

Table 1-1: Recommended probe cross reference	1-4
Table 1-2: Additional accessory connection information	1-8
Table 1-3: Line fuses	1-8
Table 1-4: Standard accessories	1-30
Table 1-5: Optional accessories	1-31
Table 3-1: Additional resolution bits	3-23
Table 3-2: Sampling mode selection	3-36
Table 3-3: How interleaving affects sample rate	3-38
Table 3-4: XY format pairs	3-46
Table 3-5: Pattern and state logic	3-70
Table 3-6: Defining and displaying waveforms	3-104
Table 3-7: Operations performed based on the waveform type ...	3-104
Table 3-8: Customizable display elements	3-114
Table 3-9: Cursor functions (types)	3-132
Table 3-10: Cursor units	3-135
Table 3-11: Math expressions and the math waveforms produced	3-156
Table 3-12: Spectral analyzer controls	3-169
Table 3-13: Window characteristics	3-180
Table A-1: TDS7000 models	A-1
Table A-2: Channel input and vertical specifications	A-4
Table A-3: Horizontal and acquisition system specifications	A-9
Table A-4: Trigger specifications	A-13
Table A-5: Display specifications	A-16
Table A-6: Input/output port specifications	A-17
Table A-7: Data storage specifications	A-19
Table A-8: Power source specifications	A-19
Table A-9: Mechanical specifications	A-20
Table A-10: Environmental specifications	A-21
Table A-11: Certifications and compliances	A-22
Table B-1: Supported measurements and their definition	B-1
Table B-2: Supported mask measurements and their definition (Option SM only)	B-3

Table D-1: File menu commands	D-1
Table D-2: Edit menu commands	D-3
Table D-3: Vertical menu commands	D-3
Table D-4: Horiz/Acq menu commands	D-4
Table D-5: Trig menu commands	D-6
Table D-6: Display menu commands	D-7
Table D-7: Cursor menu commands	D-8
Table D-8: Measure menu commands	D-9
Table D-9: Masks menu commands	D-10
Table D-10: Math menu commands	D-11
Table D-11: Utilities menu commands	D-11
Table D-12: Help menu commands	D-12

General Safety Summary

Review the following safety precautions to avoid injury and prevent damage to this product or any products connected to it. To avoid potential hazards, use this product only as specified.

Only qualified personnel should perform service procedures.

While using this product, you may need to access other parts of the system. Read the *General Safety Summary* in other system manuals for warnings and cautions related to operating the system.

To Avoid Fire or Personal Injury

Use Proper Power Cord. Use only the power cord specified for this product and certified for the country of use.

Connect and Disconnect Properly. Do not connect or disconnect probes or test leads while they are connected to a voltage source.

Ground the Product. This product is grounded through the grounding conductor of the power cord. To avoid electric shock, the grounding conductor must be connected to earth ground. Before making connections to the input or output terminals of the product, ensure that the product is properly grounded.

Observe All Terminal Ratings. To avoid fire or shock hazard, observe all ratings and markings on the product. Consult the product manual for further ratings information before making connections to the product.

Do Not Operate Without Covers. Do not operate this product with covers or panels removed.

Use Proper Fuse. Use only the fuse type and rating specified for this product.

Avoid Exposed Circuitry. Do not touch exposed connections and components when power is present.

Wear Eye Protection. Wear eye protection if exposure to high-intensity rays or laser radiation exists.

Do Not Operate With Suspected Failures. If you suspect there is damage to this product, have it inspected by qualified service personnel.

Do Not Operate in Wet/Damp Conditions.

Do Not Operate in an Explosive Atmosphere.

Keep Product Surfaces Clean and Dry.

Provide Proper Ventilation. Refer to the manual's installation instructions for details on installing the product so it has proper ventilation.

Symbols and Terms

Terms in this Manual. These terms may appear in this manual:



WARNING. *Warning statements identify conditions or practices that could result in injury or loss of life.*



CAUTION. *Caution statements identify conditions or practices that could result in damage to this product or other property.*

Terms on the Product. These terms may appear on the product:

DANGER indicates an injury hazard immediately accessible as you read the marking.

WARNING indicates an injury hazard not immediately accessible as you read the marking.

CAUTION indicates a hazard to property including the product.

Symbols on the Product. The following symbols may appear on the product:



CAUTION
Refer to Manual



WARNING
High Voltage



Protective Ground
(Earth) Terminal



Mains Disconnected
OFF (Power)



Mains Connected
ON (Power)



Standby

Preface

This is the user manual for the oscilloscope. It covers the following information:

- Describes the capabilities of the oscilloscope, how to install it and reinstall its software
- Explains how to operate the oscilloscope: how to control acquisition of, processing of, and input/output of information
- Lists specifications and accessories of the oscilloscope

About This Manual

This manual is composed of the following chapters:

- *Getting Started* shows you how to configure and install your oscilloscope and provides an incoming inspection procedure.
- *Operating Basics* uses maps to describe the various interfaces for controlling the oscilloscope, including the front panel and the software user interface. These maps provide overviews of the product and its functions from several viewpoints.
- *Reference* comprises an encyclopedia of topics (see *Overview* on page 3-1) that describe the oscilloscope interface and features, and gives background and basic information on how to use them. (The online help onboard the oscilloscope application describes the interface, features, and their usage; detailed descriptions of all programming commands are found in the *TDS7000 Series Programmer Online Guide* manual.)
- *Appendices* provides additional information including the specifications, measurements, and cleaning information.

Related Manuals and Online Documents

This manual is part of a document set of standard-accessory manuals and online documentation; this manual mainly focuses on installation, background, and user information needed to use the product features. See the following list for other documents supporting oscilloscope operation and service. (Manual part numbers are listed in *Accessories & Options* on page 1-29.)

Manual Name	Description
<i>TDS7000 Series Online Help</i>	An online help system, integrated with the User Interface application that ships with this product. The help is preinstalled in the oscilloscope.
<i>TDS7000 Series References</i>	A quick reference to major features of the oscilloscope and how they operate
<i>TDS7000 Series Programmer Online Guide</i>	An alphabetical listing of the programming commands and other information related to controlling the oscilloscope over the GPIB ¹ .
<i>TDS7000 Series Service Manual</i>	Describes how to service the oscilloscope to the module level. This optional manual must be ordered separately.

1 Located on the TDS7000 Series Product Software CD. See CD instructions for installation instructions.

For more information on how the product documentation relates to the oscilloscope operating interfaces and features, see *Documentation Map* on page 2-2.

Contacting Tektronix

Phone	1-800-833-9200*
Address	Tektronix, Inc. Department or name (if known) 14200 SW Karl Braun Drive P.O. Box 500 Beaverton, OR 97077 USA
Web site	www.tektronix.com
Sales support	1-800-833-9200, select option 1*
Service support	1-800-833-9200, select option 2*
Technical support	Email: support@tektronix.com 1-800-833-9200, select option 3* 1-503-627-2400 6:00 a.m. - 5:00 p.m. Pacific time

* **This phone number is toll free in North America. After office hours, please leave a voice mail message. Outside North America, contact a Tektronix sales office or distributor; see the Tektronix web site for a list of offices.**

Product Description

This chapter describes the TDS7000 Series Digital Phosphor Oscilloscopes and their options. Following this description are three sections:

- *Installation* shows you how to configure and install the oscilloscope, as well as how to reinstall the system software included with the product.
- *Incoming Inspection* provides a procedure for verifying basic operation and functionality.
- *Accessories* lists the standard and optional accessories for this product.

Models

This manual supports two very similar oscilloscopes, the:

- TDS7104 Digital Phosphor Oscilloscope
- TDS7054 Digital Phosphor Oscilloscope

Differences between the oscilloscopes will be called out when necessary, otherwise, the material applies to all of the oscilloscopes. The word “oscilloscope” refers to all products.

Key Features

TDS7000 Series oscilloscopes are high performance solutions for verification, debug, and characterization of sophisticated electronic designs. The series features exceptional signal acquisition performance, operational simplicity, and open connectivity to the design environment. Classic analog-style controls, a large touch-sensitive display, and graphical menus provide intuitive control. Open access to the Windows operating system enables unprecedented customization and extensibility. Key features include:

- Up to 1 GHz bandwidth and 10 GS/s real time sampling rate, depending on the model
- Record lengths up to 16,000,000 samples, depending on option
- Fast acquisition at up to 200,000 acquisitions per second for analog oscilloscope emulation and isolation of data-dependent failures during conformance/performance testing and for examination of very low-level signals in pseudo-random bit streams
- 1% DC vertical gain accuracy

- Four input channels (each with 8-bit resolution), CH 3 signal output, and auxiliary trigger input and output
- Sample, envelope, peak-detect, high-resolution, and average acquisition modes
- Full programmability, with an extensive GPIB-command set and a message-based interface
- Trigger modes include edge, logic, pulse, and sequence at up to 1 GHz bandwidth
- Powerful built-in measurement capability, including histograms, automatic measurements, and measurement statistics
- A large 10.4 inch (264.2 mm) color display that supports color grading of waveform data to show sample density
- An intuitive, graphical user interface (UI), with online help that is built in and available on screen
- Internal, removable disk storage
- Wide array of probing solutions

Product Software

The oscilloscope includes the following software:

- System Software, which includes a specially configured version of Windows 98, comes preinstalled on the oscilloscope. Windows 98 is the operating system on which the user-interface application of this product runs, and provides an open desktop for you to install other compatible applications. Do not attempt to substitute any version of Windows that is not specifically provided by Tektronix for use with your oscilloscope.
- TDS7000 Product Software. Comes preinstalled on the oscilloscope. This software, running on Windows 98, is the oscilloscope application. This software starts automatically when the oscilloscope is powered on, and provides the user interface (UI) and all other oscilloscope control functions. You can minimize or even exit/restart the oscilloscope application as your needs dictate.
- Support Software. Not preinstalled on the oscilloscope. The *TDS7000 Series Product Software* compact disc, included with the oscilloscope, contains additional software and files that may be useful to you:
 - Readme file. This pdf file contains release notes and updates that could not be included in other product documentation.

- GPIB Programmer Online Help software. This software, in an online help format, contains the information you need to program the oscilloscope through its GPIB interface. A printable pdf file of this information is also available on the compact disc.
- Performance Verification Procedures. The compact disc contains software and instructions to perform a semi-automated performance verification as well as instructions to perform a manual performance verification.

See the instructions for the *TDS7000 Series Product Software* compact disc for information about installing the support software.

Occasionally new versions of software for your oscilloscope may become available at our web site. See *Contacting Tektronix* on page xv in *Preface*.

Firmware Upgrade

Tektronix may offer firmware upgrade kits for the oscilloscope. Contact your Tektronix service representative for more information (see *Contacting Tektronix* on page xv).

Probes Supported

Table 1-1 lists the recommended probes for each oscilloscope. Descriptions of each probe follow the table.

Table 1-1: Recommended probe cross reference

Probe	TDS7054	TDS7104
Passive, 10X	P6139A	P6139A
Active CMOS/TTL	P6243	P6245
All Technology	P6245 P6249	P6245 P6249
Differential Digital	P6246, P6247, P6248	P6246, P6247, P6248
Current, AC Only	CT-6	CT-6
Current, AC/DC	TCP202	TCP202

- P6139A 10X, 500 MHz Passive probe
- P6243 Active, high speed digital voltage probe. FET. DC to 1.0 GHz
- P6245 Active, high speed digital voltage probe. FET. DC to 1.5 GHz
- P6246 Active, high bandwidth differential probe. FET. DC to 400 MHz
- P6247 Active, high bandwidth differential probe. FET. DC to 1 GHz
- P6248 Active, high bandwidth differential probe. FET. DC to 1.7 GHz
- P6249 Active, high bandwidth differential probe. FET. DC to 4 GHz
- TCP 202 Current Probe, DC to 50 MHz, 15 A DC
- CT-6 Current probe — designed for temporary in-circuit installation. 250 kHz to 2 GHz, 50 Ω input

Installation

This chapter covers installation of the oscilloscope, addressing the following topics:

- *Unpacking* on page 1-5
- *Checking the Environment Requirements* on page 1-6
- *Connecting Peripherals* on page 1-6
- *Powering On the Oscilloscope* on page 1-8
- *Powering Off the Oscilloscope* on page 1-9
- *Creating an Emergency Startup Disk* on page 1-10
- *Backing Up User Files* on page 1-10
- *Installing Software* on page 1-11
- *Connecting to a Network* on page 1-14



CAUTION. *Be sure to create your emergency startup disk as described on page 1-10. You may need that disk if you ever need to reinstall Windows 98 from the oscilloscope hard drive.*

Unpacking

Verify that you have received all of the parts of your oscilloscope. The graphical packing list shows the standard accessories that you should find in the shipping carton (probes depend on the option you ordered.) You should also verify that you have:

- The correct power cord for your geographical area.
- The compact discs that include copies of the software installed on the oscilloscope and additional support software that may be useful to you: the Operating System Restore, Product Software, and Optional Applications Software. Store the product software in a safe location where you can easily retrieve it.

NOTE. *The certificate of authenticity (Windows 98 licence agreement) is attached to the rear of your oscilloscope. This certificate proves your ownership of the Windows operating system in your oscilloscope. If you lose or misplace this certificate, you might have to purchase a new Windows license if the hard disk in your oscilloscope ever needs rebuilding or replacement.*

- All the standard and optional accessories that you ordered.

Remember to fill out and send in the customer registration card. The registration card is packaged with this manual.

Checking the Environment Requirements

Read this section before attempting any installation procedures. This section describes site considerations, power requirements, and ground connections for your oscilloscope.

Site Considerations

The oscilloscope is designed to operate on a bench or on a cart in the normal position (on the bottom feet). For proper cooling, at least three inches (7.62 cm) of clearance is required on both sides of the oscilloscope, and the bottom requires the clearance provided by the oscilloscope feet.

If you operate the oscilloscope while it is resting on the rear feet, make sure that you properly route any cables coming out of the rear of the oscilloscope to avoid damaging them.



CAUTION. *Keep the bottom and sides of the oscilloscope clear of obstructions to ensure proper cooling.*

Operating Requirements

The Specifications in Appendix A list the operating requirements for the oscilloscope. Power source, temperature, humidity, and altitude are listed.

Connecting Peripherals

The peripheral connections are the same as those you would make on a personal computer. The connection points are shown in Figure 1-1. See Table 1-2 on page 1-8 for additional connection information.



CAUTION. To avoid product damage, power off the oscilloscope before installing any accessories except a USB mouse or keyboard to the oscilloscope connectors. (You can connect and disconnect USB devices with the power on.) See Powering Off the Oscilloscope on page 1-9.

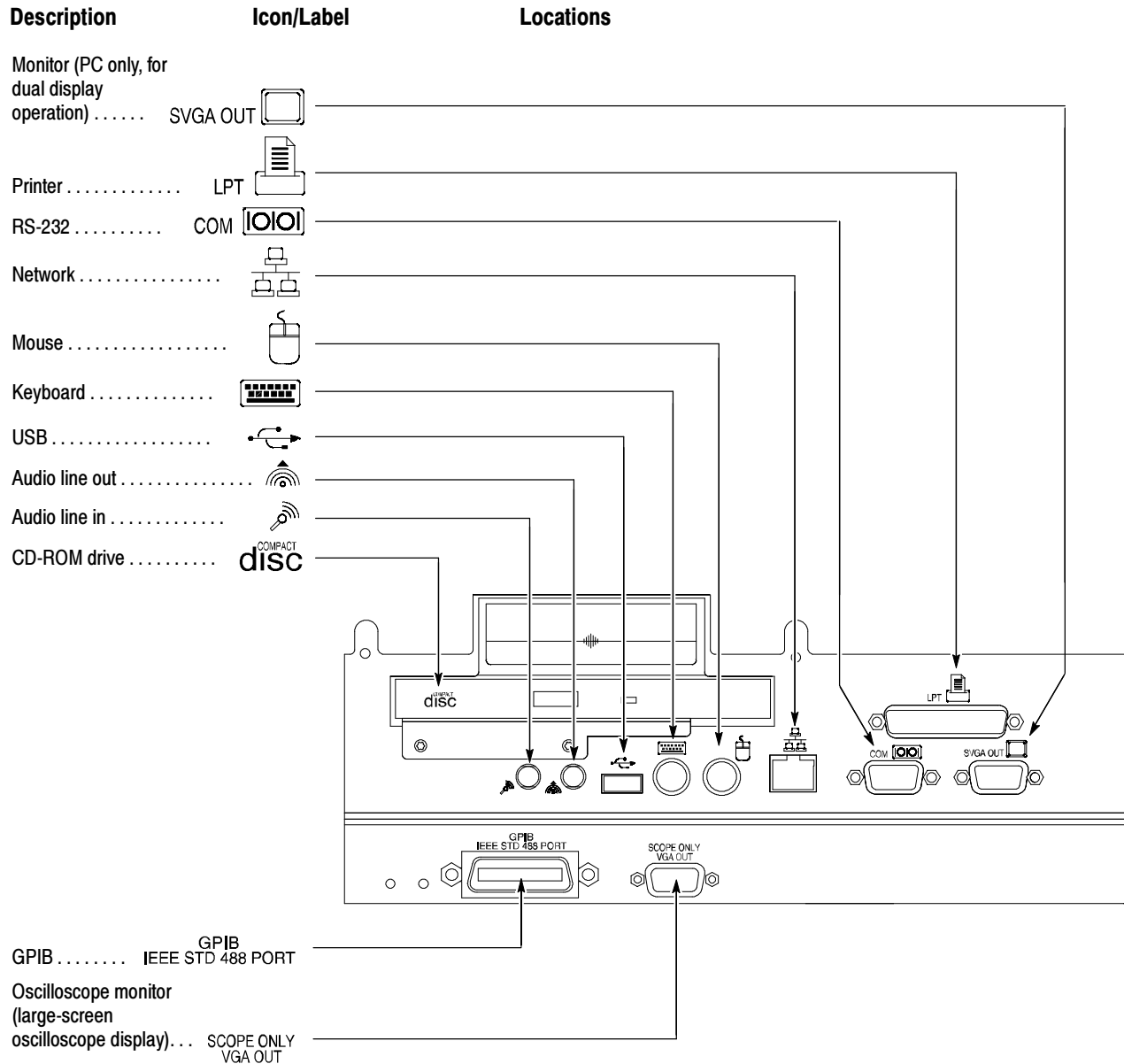

Figure 1-1: Locations of peripheral connectors on rear panel

Table 1-2: Additional accessory connection information

Item	Description
Monitor	If you use a non-standard monitor, you may need to change the Windows 98 display settings to achieve the proper resolution for your monitor.
Printer	Connect the printer to the EPP (enhanced parallel port) connector directly. If your printer has a DB-25 connector, use the adapter cable that came with your printer to connect to the EPP connector. For information on printer usage, see <i>Printing Waveforms</i> on page 3-238.
Rackmount	Refer to the <i>TDS7000 Rackmount Installation Instructions</i> for information on installing the rackmount kit.
Other	Refer to the Readme file on the <i>TDS7000 Series Product Software</i> CD for possible additional accessory installation information not covered in this manual.

Powering On the Oscilloscope

Follow these steps to power on the oscilloscope for the first time.

1. Either one of the following fuse sizes can be used, each size requires a different fuse cap. Both fuses must be the same type. See Table 1-3 and Figure 1-2.

Table 1-3: Line fuses

Line voltage	Description	Part number
100 V to 250 V operation	UL198G and CSA C22.2, No. 59, fast acting: 8 A, 250 V	Tektronix 159-0046-00 Bussman ABC-8 Littelfuse 314008
	IEC127, sheet 1, fast acting "F", high breaking capacity: 6.3 A, 250 V	Tektronix 159-0381-00 Bussman GDA-6.3 Littelfuse 21606.3

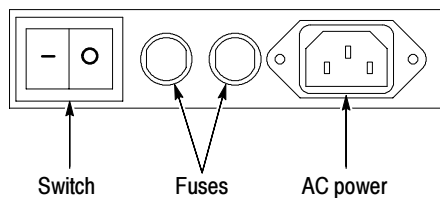

Figure 1-2: Line fuse and power cord connector locations, rear panel



CAUTION. Connect the keyboard, mouse, and other accessories before applying power to the product.

2. Connect the power cord.
3. If you have an external monitor, connect the power cord and power on the monitor.
4. Turn the Power switch on at the rear panel. (See Figure 1-2 on page 1-8 for switch location.)
5. If the oscilloscope does not power up, push the On/Standby switch to power on the oscilloscope (see Figure 1-3 for the switch location).

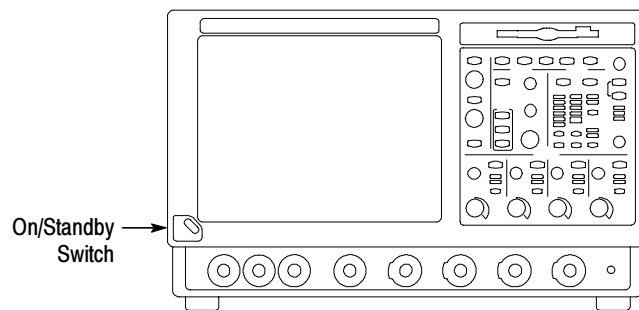

Figure 1-3: On/Standby switch location

Shutting Down the Oscilloscope

When you push the front-panel On/Standby switch, the oscilloscope starts a shutdown process (including a Windows shutdown) to preserve settings and then removes power from most circuitry in the oscilloscope. Avoid using the rear-panel power switch or disconnecting the line cord to power off the oscilloscope.

NOTE. If you do not use the On/Standby switch to shut down the oscilloscope, before powering off the oscilloscope, the oscilloscope will be in the factory Default Setup when powered on the next time.

To completely remove power to the oscilloscope, perform the shutdown just described, set the power switch on the rear panel to off, and then remove the power cord from the instrument.

Creating an Emergency Startup Disk

Now that you have completed the basic installation process, you should create an emergency startup disk that you can use to restart your oscilloscope in case of a major hardware or software failure. You should create this disk, and then store it in a safe place.



CAUTION. *Create this disk and store it in a safe place. It may allow you to recover your Windows 98 installation without rebuilding the entire oscilloscope hard disk.*

The emergency startup disk contains basic files to restart your oscilloscope. It also contains files to check and format the hard disk.

Follow these steps to create the emergency startup disk:

1. Minimize the oscilloscope application by selecting Minimize in the File menu.
2. Click the Windows Start button, point to Settings, and click Control Panel.
3. In the Control Panel window, double-click Add/Remove Programs.
4. Click the tab for the Startup Disk page.
5. Insert a floppy disk into the disk drive and follow the on-screen instructions to create the startup disk.

Backing Up User Files

You should always back up your user files on a regular basis. Use the Back Up tool to back up files stored on the hard disk. The Back Up tool is located in the System Tools folder in the Accessories folder.

1. Minimize the oscilloscope application by selecting Minimize in the File menu.
2. Click the Windows Start button.
3. Select Programs, Accessories, System Tools, Backup in the Start menu.
4. Use the backup tool that displays to select your backup media and to select the files and folders that you want to back up. Use the Windows online help for information on using the Backup tool. You can back up to the floppy drive, or to a third-party storage device over the printer port (rear panel).

Installing Software

The oscilloscope system and application software is preinstalled at the factory. If you have to reinstall the software for any reason, refer to the instructions that accompany the CDs that are shipped with the oscilloscope. If you need to restore the operating system, you also need the Windows licence information from the Certificate of Authenticity that is shipped with the oscilloscope.

Software Release Notes

Read the software release notes README.TXT ASCII file on the product-software CD before performing installation procedures. This file contains additional installation and operation information that supersedes other product documentation.

To view the README.TXT file, open the Notepad Windows accessory and open the file on the *TDS7000 Series Product Software CD*.

Accessory Software

The *TDS7000 Series Product Software CD* also contains accessory software and files that you can choose to install in the oscilloscope or in another computer. Refer to the instructions that accompany the CD for installation information.

GPIB Programmer Online Help Software. You can install the GPIB Programmer online help on the oscilloscope, but it may be more convenient to install it on the PC that is functioning as the GPIB system controller. From the system controller, you can copy and paste commands from the help directly into your test programs. The programmer information contains the following content:

- GPIB configuration information for the oscilloscope
- Lists of the command groups and the commands they contain
- Detailed command descriptions including syntax and examples
- Status and error messages
- Programming examples

The CD also contains a printable version of the programmer information, in the form of a PDF file.

Semi-Automated Performance Verification Procedure. This software provides a semi-automated method to verify the oscilloscope performance. The installer installs the software and a PDF file that provides instructions to perform the procedure. The PDF file also lists the specific test equipment required to perform the procedure.

You should not install this software on the oscilloscope, but rather on the PC you plan to use as a GPIB controller. The GPIB controller must be equipped with a National Instruments GPIB Controller card and software, and must run Windows 95/98 or NT.

Manual Performance Verification Procedure. This is a printable PDF file that describes a manual method to verify the oscilloscope performance using generic test equipment.

Optional Accessory Software. The *Optional Applications Software* CD contains programs that you can install and run five times per application. You can then purchase an upgrade from Tektronix if you decide that you want to continue to use the application. Refer to the instructions that accompany the CD for installation information.

Desktop Applications

You can install desktop application software on the oscilloscope. The oscilloscope has been tested with the following software products installed:

- Microsoft Office 98 (Word, Excel, Powerpoint, etc.)
- MathCad
- MATLAB

Other software products may be compatible but have not been tested by Tektronix. If the oscilloscope malfunctions after you install software you should uninstall the software and then reinstall the oscilloscope application to restore proper operation.

Exiting the Oscilloscope Application. Before installing other desktop applications, you should exit the oscilloscope application. Follow these steps to exit the oscilloscope application:

1. Connect a keyboard and mouse to the oscilloscope.
2. While holding down the **CTRL** and **ALT** keys, press the **DELETE** key.
3. In the Close Program dialog box, select **TDS7000** and then select **End Task** to stop the oscilloscope application.
4. If a confirmation dialog box appears, select **End Task** again.
5. Press the **CTRL**, **ALT**, and **DELETE** keys again.
6. In the Close Program dialog box, select **Windowsscopervices** and then select **End Task**.
7. If a confirmation dialog box appears, select **End Task** again.

8. Press the **CTRL**, **ALT**, and **DELETE** keys a third time.
9. In the Close Program dialog box, verify that the tasks **TDS7000** and **Windowsscopervices** are not running, and then select **Cancel** to close the dialog box.

The oscilloscope application will restart after you restart the entire system, following the installation of the desktop application software.

TDS7000 Options

Some TDS7000 options contain software that needs to be installed and/or enabled. To do the installation, follow the specific instructions that come with the option.

Tektronix provides a key that you must enter (one time) to enable all the options that you have purchased for your oscilloscope. To enter the key, select **Option Installation** in the **Utility** menu, and then follow the on-screen instructions.

Enabling Your LAN and Connecting to a Network

You can connect the oscilloscope to a network to enable printing, file sharing, internet access, and other communications functions. Before you make the connection, do the following steps to enable network access to the oscilloscope:

1. Begin with the oscilloscope power shut down.
2. Attach a keyboard and mouse to the oscilloscope.
3. Power on the oscilloscope.
4. As the oscilloscope begins to boot, press the **F2** key on the keyboard repeatedly until the message “**Entering SETUP**” (Loading SETUP on some instruments) appears.
5. In the BIOS Setup Utility use the right-arrow key on the keyboard to highlight the **Advanced** menu at the top of the screen.
6. Use the arrow down key to highlight **PCI Configuration** (Peripheral Configuration on some instruments) in the Advanced screen, and then press **Enter**.
7. Use the arrow down key to highlight **Embedded Ethernet Controller** (LAN Device on some instruments) in the Peripheral Configuration screen, and then press **Enter**.
8. Use the arrow up or down key to highlight **Enabled** and then press **Enter**.
9. Press the **F10** key to save and exit. Confirm the Save of Configuration changes when you are prompted on screen.
10. Use the Windows network setup utility to define the oscilloscope as a network client and configure it for your network. You can find the network setup utility in the Windows **Start** menu if you select **Settings > Control Panel** and then double click **Network**. You should consult your network administrator for specific instructions to make these settings.

NOTE. *If you want to disable network access for the oscilloscope, perform the above procedure except substitute Disabled for the command listed in step 8. The oscilloscope will boot faster with network access disabled.*

Setting up a Dual Display

Use the following steps to set up the oscilloscope for dual display operation. You can operate the oscilloscope while having full use of Windows and other applications on the external monitor.

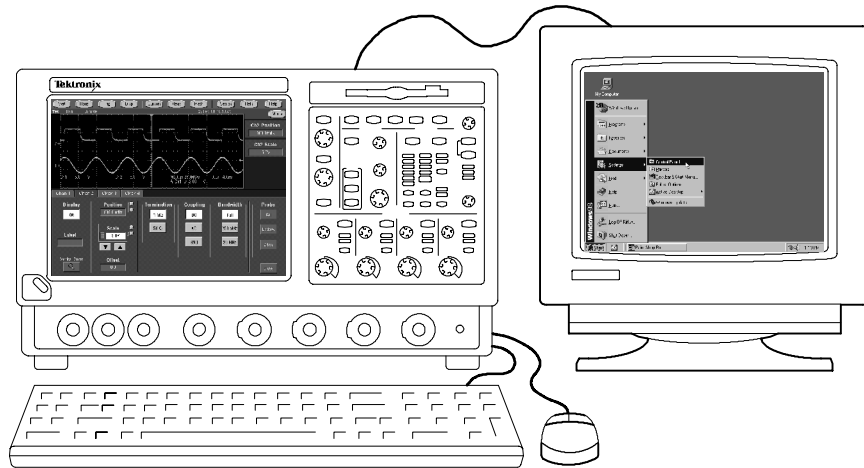

1. Shut down the oscilloscope using the On/Standby switch so you can connect an external monitor to the rear of the oscilloscope.
2. Connect a keyboard and mouse to the oscilloscope.
3. Connect an external monitor to the upper SVGA port of the rear panel of the oscilloscope.
4. Power on the oscilloscope and the external monitor.
5. Watch for a message on the external monitor telling you that Windows has successfully initialized the display adapter.
6. The oscilloscope should detect that the new monitor was connected. Follow the instructions on the oscilloscope display to install new drivers for the monitor.
7. Type a Control-M to minimize the oscilloscope application.
8. In the Windows desktop, right click the mouse and then select Properties to display the Display Properties dialog box.
9. Select the Settings tab and click the grayed-out monitor in the display box.
10. Click yes when you are prompted to enable the new monitor.
11. Set the resolution you want to use on the external monitor.
12. Click on the external monitor in the display box and drag it to the correct orientation



CAUTION. Do not change the resolution or color settings for the internal LCD monitor. The internal resolution must be 640 x 480 and the color setting must be High Color (16 bit).

13. Click OK to apply the settings. The new monitor will display additional desktop area.

To make the best use of the new display area, do these additional steps to move the Windows controls to the external monitor:

1. Click (and hold) on the Windows task bar in the area shown in Figure 1-4 and then drag it upwards and toward the external monitor. The task bar will first go to the side of the internal monitor, then to the side of the external monitor and finally to the bottom of the external monitor.



Figure 1-4: Drag area for Windows task bar

2. Release the mouse when the task bar is where you want it to be.
3. Select all the Windows desktop icons on the internal monitor and drag them to a position on the external monitor.
4. If you use the oscilloscope help system, you can drag the help windows to the external monitor so that you can read them while you operate the oscilloscope.
5. When you open any Windows application, drag the windows from the application to the external monitor.

Incoming Inspection

This chapter contains instructions for performing the *Incoming Inspection Procedure*. This procedure verifies that the oscilloscope is operating correctly after shipment, but does not check product specifications. This procedure contains the following parts:

- *Self Tests* on page 1-17 provides instructions for performing the internal self tests.
- *Functional Tests* on page 1-18 measures the time- and amplitude-reference signals at the PROBE COMPENSATION connector.
- *Perform Extended Diagnostics* on page 1-26 provides instructions for performing internal self calibration and the extended diagnostics.

If the oscilloscope fails any test within this section, it may need service. To contact Tektronix for service, see *Contacting Tektronix* on page xv of *Preface*.

Make sure you have put the oscilloscope into service as detailed in *Installation* starting on page 1-5. Then assemble the following test equipment and precede with the procedures that follow.

Assemble Equipment

Self tests do not require any test equipment. The functional tests require the following test equipment:

- One BNC cable, such as Tektronix part number 012-0076-00
- One 1.44 Mbyte, 3.5 inch formatted disk

Self Tests

This procedure uses internal routines to verify that the oscilloscope functions and was adjusted properly. No test equipment or hookups are required.

Equipment required	None
Prerequisites	Power on the oscilloscope and allow a 20 minute warm-up before doing this procedure.

1. *Verify that internal diagnostics pass:* Do the following substeps to verify passing of internal diagnostics.
 - a. *Display the System diagnostics menu:*
 - If the oscilloscope is in tool-bar mode, click the **MENU** button to put the oscilloscope into menu bar mode.
 - From the **Utility** menu, select **Instrument Diagnostics** This displays the diagnostics control window.
 - b. *Run the System Diagnostics:*
 - First disconnect any input signals from all four channels.
 - Click the **Run** button in the diagnostics control window.
 - c. *Wait:* The internal diagnostics do an exhaustive verification of proper oscilloscope function. This verification will take five to fifteen minutes. When the verification is finished, the resulting status will appear in the diagnostics control window.
 - d. *Verify that no failures are found and reported on-screen.* All tests should pass. If any failures occur, click the **Error Log** button for details.
 - e. *Run the signal-path compensation routine:*
 - From the **Utilities** menu, select **Instrument Calibration** This displays the oscilloscope calibration control window.
 - If required because the oscilloscope is in service mode, select the **Signal Path** button under Calibration Area.
 - Touch the **Calibrate** button to start the routine.
 - f. *Wait:* Signal-path compensation may take five to ten minutes to run.
 - g. *Confirm signal-path compensation returns passed status:* Verify that the word **Pass** appears in the oscilloscope calibration control window.
2. *Return to regular service:* Click the **Close** button to exit the oscilloscope calibration control window.

Functional Tests

The purpose of these procedures is to confirm that the oscilloscope functions properly. The following equipment is required:

- A BNC cable
- A 3.5 inch, 1.44 Mbyte, formatted floppy disk to check the file system

STOP. These procedures verify functions; that is, they verify that the oscilloscope features operate. They do not verify that they operate within limits.

Therefore, when the instructions in the functional tests that follow call for you to verify that a signal appears on-screen “that is about five divisions in amplitude” or “has a period of about six horizontal divisions,” etc., do **NOT** interpret the quantities given as limits.

STOP. DO NOT make changes to the front-panel settings that are not called out in the procedures. Each verification procedure will require you to set the oscilloscope to certain default settings before verifying functions. If you make changes to these settings, other than those called out in the procedure, you may obtain invalid results. In this case, just redo the procedure from step 1.

When you are instructed to push a front-panel button or screen button, the button may already be selected (its label will be highlighted). If this is the case, it is not necessary to push the button.

Equipment required	One BNC cable, such as Tektronix part number 012-0076-00
Prerequisites	None

1. *Initialize the oscilloscope:* Push the front-panel **DEFAULT SETUP** button.
2. *Hook up the signal source:* Connect the BNC cable from the probe compensation output to the channel input that you want to test (beginning with CH 1) as shown in Figure 1-5.

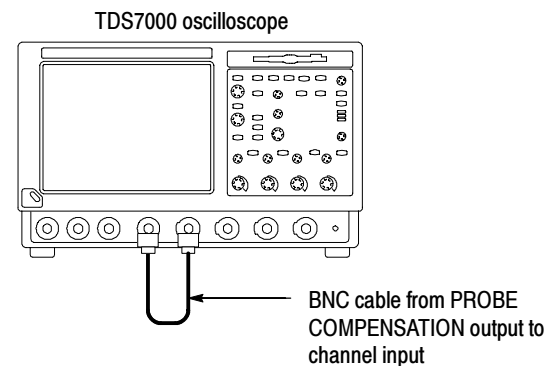

Figure 1-5: Universal test hookup for functional tests - CH 1 shown

3. *Turn off all channels:* If any of the front-panel channel buttons are lighted, push those buttons to turn off the displayed channels. See Figure 1-6.

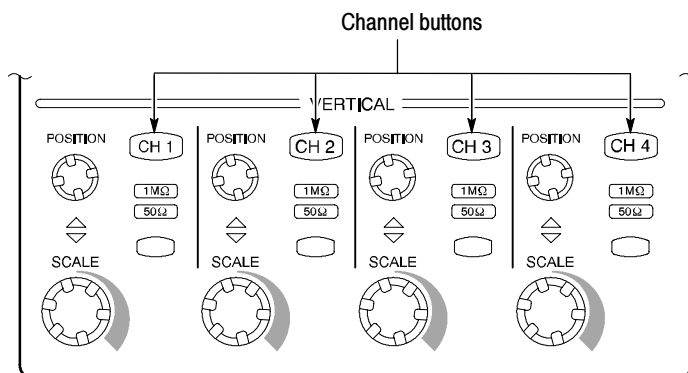

Figure 1-6: Channel button location

4. *Select the channel to test:* Push the channel button for the channel you are currently testing. The button lights and the channel display comes on.
5. *Set up the oscilloscope:* Push the front panel **AUTOSET** button. This sets the horizontal and vertical scale for a usable display and sets the trigger source to the channel you are testing.
6. *Verify that the channel is operational:* Confirm that the following statements are true.
- The vertical scale readout for the channel under test shows a setting of 500 mV, and a square-wave probe-compensation signal about 2 divisions in amplitude is on-screen.
 - The front-panel vertical **POSITION** knob (for the channel you are testing) moves the signal up and down the screen when rotated.
 - Turning the vertical **SCALE** knob counterclockwise (for the channel you are testing) decreases the amplitude of the waveform on-screen, turning the knob clockwise increases the amplitude, and returning the knob to 500 mV returns the amplitude to about 2 divisions.
7. *Verify that the channel acquires in all acquisition modes:* From the **Horiz/Acq** menu, select **Horizontal/Acquisition Setup . . .** Click the **Acquisition** tab in the control window that displays. Click each of the five acquisition modes and confirm that the following statements are true (see *Using the Acquisition Controls* on page 3-22 for more information).
- Sample mode displays an actively acquiring waveform on-screen. (Note that there is a small amount of noise present on the square wave).

- Peak Detect mode displays an actively acquiring waveform on-screen with the noise present in Sample mode “peak detected.”
 - Hi Res mode displays an actively acquiring waveform on-screen with the noise that was present in Sample mode reduced.
 - Average mode displays an actively acquiring waveform on-screen with the noise reduced.
 - Envelope mode displays an actively acquiring waveform on-screen with the noise displayed.
8. *Test all channels:* Repeat steps 2 through 7 until all four input channels are verified.
 9. *Remove the test hookup:* Disconnect the BNC cable from the channel input and the probe compensation output.

Equipment required	One BNC cable, such as Tektronix part number 012-0076-00
Prerequisites	None

1. *Initialize the oscilloscope:* Push the front-panel **DEFAULT SETUP** button.
2. *Hook up the signal source:* Connect the BNC cable from the probe compensation output to the CH 1 input as shown in Figure 1-7.

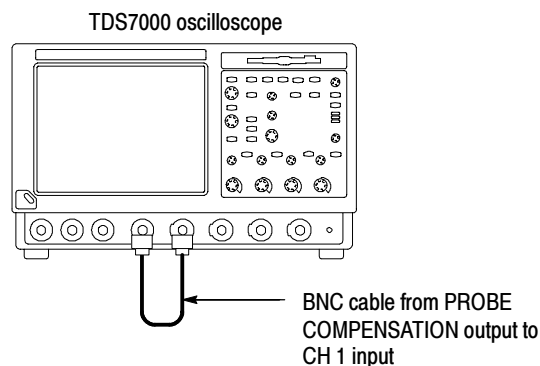

Figure 1-7: Setup for time base test

3. *Set up the oscilloscope:* Push the front panel **AUTOSET** button.
4. *Set the time base:* Set the horizontal **SCALE** to **200 μ s/div**. The time-base readout is displayed at the bottom of the graticule.
5. *Verify that the time base operates:* Confirm the following statements.

- One period of the square-wave probe-compensation signal is about five horizontal divisions on-screen for the 200 $\mu\text{s}/\text{div}$ horizontal scale setting.
- Rotating the horizontal **SCALE** knob clockwise expands the waveform on-screen (more horizontal divisions per waveform period), counter-clockwise rotation contracts it, and returning the horizontal scale to 200 $\mu\text{s}/\text{div}$ returns the period to about five divisions.
- The horizontal **POSITION** knob positions the signal left and right on-screen when rotated.

6. *Verify horizontal delay:*

a. *Center a rising edge on screen:*

- Set the horizontal **POSITION** knob so that the rising edge where the waveform is triggered is lined up with the center horizontal graticule.
- Change the horizontal **SCALE** to **20 $\mu\text{s}/\text{div}$** . The rising edge of the waveform should remain near the center graticule and the falling edge should be off screen.

b. *Turn on and set horizontal delay:*

- From the **Horiz/Acq** menu, select **Horizontal/Acquisition Setup**
- Click the **Horizontal** tab in the control window that displays.
- Click the **Delay Mode** button to turn delay on.
- Double click the **Horiz Delay** control in the control window to display the pop-up keypad. Click the keypad buttons to set the horizontal delay to **500 μs** and then click the **ENTER** key.

c. *Verify the waveform:* Verify that a falling edge of the waveform is within a few divisions of center screen.

d. *Adjust the horizontal delay:* Rotate the upper multipurpose knob to change the horizontal delay setting. Verify that the falling edge shifts horizontally. Rotate the front-panel horizontal **POSITION** knob. Verify that this knob has the same effect (it also adjusts delay, but only when delay mode is on).

e. *Verify the delay toggle function:*

- Rotate the front-panel horizontal **POSITION** knob to center the falling edge horizontally on the screen.

- Change the horizontal **SCALE** to **40 ns/div**. The falling edge of the waveform should remain near the center graticule. If not, readjust the delay setting to center the falling edge.
 - Push the front-panel **DELAY** button several times to toggle delay off and on and back off again. Verify that the display switches quickly between two different points in time (the rising and falling edges of this signal).
7. *Remove the test hookup:* Disconnect the probe from the channel input and the probe compensation output.

Equipment required	One BNC cable, such as Tektronix part number 012-0076-00
Prerequisites	None

1. *Initialize the oscilloscope:* Push the front-panel **DEFAULT SETUP** button.
2. *Hook up the signal source:* Connect the BNC cable from the probe compensation output to the CH 1 input as shown in Figure 1-8.

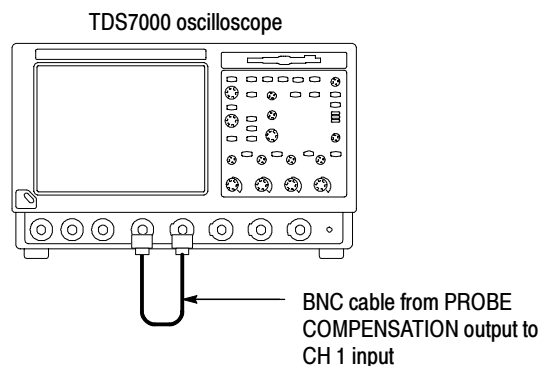

Figure 1-8: Setup for trigger test

3. *Set up the oscilloscope:* Push the front-panel **AUTOSET** button.
4. *Verify that the main trigger system operates:* Confirm that the following statements are true.
 - The trigger level readout for the A (main) trigger system changes with the trigger-**LEVEL** knob.
 - The trigger-**LEVEL** knob can trigger and untrigger the square-wave signal as you rotate it. (Leave the signal *untriggered*).

- Pushing the front-panel trigger **LEVEL** knob sets the trigger level to the 50% amplitude point of the signal and triggers the signal that you just left untriggered. (Leave the signal triggered.)
- 5. *Verify that the delayed trigger system operates:*
 - a. *Set up the delayed trigger:*
 - From the **Trig** menu, select **A→B Sequence . . .** This displays the A→B Sequence tab of the trigger setup control window.
 - Click the **Trig After Time** button under A Then B.
 - Click the **B Trig Level** control in the control window.
 - b. *Confirm that the following statements are true:*
 - The trigger-level readout for the B trigger system changes as you turn the lower multipurpose knob.
 - As you rotate the lower multipurpose knob, the square-wave probe-compensation signal can become triggered and untriggered. (Leave the signal triggered.)
 - c. *Verify the delayed trigger counter:*
 - Double click the **Trig Delay** control to pop up a numeric keypad for that control.
 - Click on the keypad to enter a trigger delay time of **1 second** and then click **Enter**.
 - Verify that the trigger **READY** indicator on the front panel flashes about once every second as the waveform is updated on-screen.
- 6. *Remove the test hookup:* Disconnect the cable from the channel input and the Probe Compensation output.

Equipment required	One BNC cable, such as Tektronix part number 012-0076-00 One 720 K or 1.44 Mbyte, 3.5 inch DOS-compatible formatted disk.
Prerequisites	None

1. *Initialize the oscilloscope:* Push the front-panel **DEFAULT SETUP** button.
2. *Hook up the signal source:* Connect the BNC cable from the probe compensation output to the CH 1 input as shown in Figure 1-9.

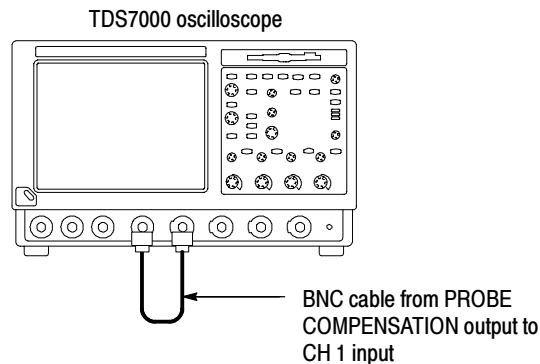

Figure 1-9: Setup for the file system test

3. *Insert the test disk:* Insert the floppy disk in the floppy disk drive at the top of the front panel.
4. *Set up the oscilloscope:* Push the front panel **AUTOSET** button.
5. *Set the time base:* Set the horizontal **SCALE** to **1 ms/div**. The time-base readout is displayed at the bottom of the graticule.
6. *Save the settings:*
 - a. Pull down the **File** menu to select **Instrument Setup . . .**. This displays the oscilloscope setups control window.
 - b. Click the **Save** button under Save settings to file in the control window. This displays a familiar Windows dialog box for choosing a destination directory naming the file.
 - c. In the Save Instrument Setup As dialog box, select the **3¹/₂ Floppy (A:)** icon in the **Save in:** drop-down list to set the save destination to the floppy disk.
 - d. Note the default file name and then click the **Save** button to save the setup to the default file name.
7. *Change the settings again:* Set the horizontal **SCALE** to **200 μ s/div**.
8. *Verify the file system works:*
 - a. Click the **Recall Setups** tab in the control window.
 - b. Click the **Recall** button under Recall settings from file in the control window. This displays a familiar Windows dialog box for locating the settings file that you want to recall.
 - c. In the Recall Instrument Setup dialog box, select the **3¹/₂ Floppy (A:)** icon in the **Look in:** drop-down list.

- d. Locate and then double click in the dialog box on the setup file that you previously stored.
 - e. Verify that the oscilloscope retrieved the saved setup from the disk. Do this by noticing the horizontal **SCALE** is again 1 ms and the waveform shows ten cycles just as it did when you saved the setup.
9. *Remove the test hookup:*
- a. Disconnect the probe from the channel input and the probe compensation output.
 - b. Remove the floppy disk from the floppy disk drive.

Perform the Extended Diagnostics

Extended diagnostics and self calibration perform a more detailed functionality check than the incoming inspection and Power-on diagnostics

NOTE. Allow a 30-minute warm-up before running the self calibration.

Disconnect any attached probes from the oscilloscope. Then select the Utilities menu. Run the self calibration followed by the extended diagnostics by first selecting the Instrument Calibration (see page 3-141 for additional information on signal path compensation) and then the Instrument Diagnostics tabs. Results of the tests display on their property pages.

Checking the Underlying System (Optional)

To check the hardware and Windows software underlying the TDS oscilloscope UI (user interface), run the QA+Win32 diagnostics from the Windows Start menu:

1. Exit the oscilloscope application before running the external diagnostics.
 - a. Display the Task Manager by pressing CTRL, ALT, and Delete.
 - b. Select TDS7000 and then touch **End Task**.

NOTE. About 10 seconds after touching **End Task**, a program not responding window may appear. If it does, touch **End Task**.

- c. Display the Task Manager by pressing CTRL, ALT, and Delete.
 - d. Select Windowsscopervices and then touch **End Task**.
2. Click Start, then click Programs in the Start Menu. Finally, click Sykes Diagnostics and then QA+Win32.

3. Click the Quick Test button to run the diagnostics suite.
4. Check test results in scrollable results listing in the lower left corner of the QAPlus test window. All tests except the audio test should pass.
5. Dismiss the QAPlus/Win diagnostics: Select Exit in the File menu.
6. Restart your oscilloscope UI software: Click Start, then click Programs in the Start Menu. Finally, click Tektronix Oscilloscope and then TekScope.

Accessories & Options

This section lists the standard and optional accessories available for the oscilloscope, as well as the product options.

Options

The following options can be ordered for the oscilloscope:

- Option 1K: K4000 Instrument Cart
- Option 1R: Rack Mount Kit (includes: hardware and instructions for converting to rackmount configuration)
- Option 1M: Long record length: 500 ksamples per channel, 2 Msamples maximum
- Option 2M: Long record length: 2 Msamples per channel, 8 Msamples maximum
- Option 3M: Long record length: 4 Msamples per channel, 16 Msamples maximum
- Option 30: No probes
- Option 33: Add one P6158, 3 GHz, low capacitance, 20x divider probe
- Option 34: Add one P6247, 1 GHz differential probe
- Option 35: Add one P6243, 1 GHz active probe
- Option 36: Add one P6139A, 500 MHz passive probe
- Option 37: Add one P6245, 1.5 GHz active probe
- Option 39: Add one P6248, 1.5 GHz differential probe
- International Power Cords Options:
 - Option A1 - Universal European 230 V, 50 Hz
 - Option A2 - United Kingdom 230 V, 50 Hz
 - Option A3 - Australian 230 V, 50 Hz
 - Option A5 - Switzerland 230 V, 50 Hz
 - Option AC - China 230 V, 50 Hz
 - Option A99 - No power cord

- Option SM: Serial Communications Mast Testing
- Option TDS7UP: Field upgrade options. Many are available. Contact Tektronix (see page xv) for a complete list of available TDS7UP options
- Option J1: TDSJIT2 Jitter Analysis application
- Option J2: TDSDDM2 Disk Drive Measurements application
- Option JT3: TDSJIT3 Advanced Jitter Analysis application with random and deterministic jitter analysis
- Option CP2: TDSCPM2 Compliance Testing for ITU-T G.703 and ANSI T1.102 communications standards
- Option USB: TDSUSBS-USB2.0 Compliance Test application (Software only)
- Service offerings:
 - Opt. C3: Calibration services extended to cover three years
 - Opt. C5: Calibration services extended to cover five years
 - Opt. D1: Calibration data report
 - Opt. D3: Test Data for calibration services in Opt. C3
 - Opt. D5: Test Data for calibration services in Opt. C5
 - Opt. R3: Repair warranty extended to cover three years
 - Opt. R5: Repair warranty extended to cover five years

Accessories

This section lists the standard and optional accessories available for this oscilloscope.

Standard The following accessories are shipped with the oscilloscope:

Table 1-4: Standard accessories

Accessory	Part number
<i>TDS7000 Series graphical packing list</i>	071-0710-xx
<i>TDS7000 Series User Manual</i>	071-0700-xx
<i>TDS7000 Series Reference kit</i>	020-2404-xx

Table 1-4: Standard accessories (Cont.)

Accessory	Part number
<i>TDS7000 Series Product Software CD</i>	063-3376-xx
<i>TDS7000 Series Operating System Restore CD</i>	020-2437-xx
<i>TDS7000 Series Online Help</i> (part of the application software)	—
Optional Applications Software CD and Documentation Kit	020-2450-xx
Oscilloscope Analysis and Connectivity Made Easy Kit	020-2449-xx
Option SM and ST User Manual	071-1035-xx
Performance Verification (a pdf file on the <i>TDS7000 Series Product Software CD</i>)	—
<i>TDS7000 Series Programmer Online Guide</i> (files on the <i>TDS7000 Series Product Software CD</i>)	—
NIST, Z540-1, and ISO9000 Calibration Certificate	—
U.S. Power Cord	161-0104-00
Mouse	119-6298-xx
Front Cover	200-4519-xx
Accessory Pouch	016-1441-xx
Probe Calibration and Deskew Fixture, with instructions and BNC cable	067-0405-xx
Four P6139A Probes (with TDS7054 only)	—
Click'N Burn Software CD	063-3575-xx

Optional

The accessories in Table 1-5 are orderable for use with the oscilloscope at the time this manual was originally published. Consult a current Tektronix catalog for additions, changes, and details.

Table 1-5: Optional accessories

Accessory	Part number
<i>TDS7000 Series Service Manual</i>	071-0711-xx
Transit Case	016-1522-xx
Scope Cart	K4000 (Option 1K)
P6158 20x 1 k-ohm low capacitance voltage divider probe	P6158
P6139A 500 MHz passive 10x probe	P6139A
P6243 1 GHz high speed active probe	P6243

Table 1-5: Optional accessories (Cont.)

Accessory	Part number
P6245 1.5 GHz high speed active probe	P6245
P6246 400 MHz differential probe	P6246
P6247 1 GHz differential probe	P6247
P6248 1.5 GHz differential probe	P6248
TCP202 DC to 50 MHz current probe	TCP202
CT6 high frequency current probe	CT6
AM503S DC/AC current measurement system	AM503S
P5205 high voltage differential probe	P5205
P5210 high voltage differential probe	P5210
P6015A high voltage probe	P6015A
ADA400A differential preamplifier	ADA400A
P6701A/B optical/electrical converter (multi-mode)	P6701A/B
P6703A/B optical/electrical converter (single-mode)	P6703A/B
AMT75 1 GHz 75-ohm adapter	AMT75
VocalLink Pro Voice Controlled Software	VCLNKP
VocalLink Basic Voice Controlled Software	VCLNKB
Wavewriter: AWG and waveform creation software	S3FT400
TekTMS: Test Management System	SFT001
LabWindows	S3FG910
WSTRO WaveStar Software	WSTRO
GPIB cable (1 m)	012-0991-01
GPIB cable (2 m)	012-0991-00
RS-232 cable	012-1298-xx
PS-2 keyboard	118-9402-00
USB Keyboard	119-6297-xx
Centronics cable	012-1250-xx
Replacement hard disk	650-4075-xx

Operational Maps

This chapter acquaints you with how the oscilloscope functions and operations. It consists of several maps that describe the system, its operation, and its documentation:





- *Documentation Map*, on page 2-2, lists the documentation that supports the oscilloscope.
- *System Overview Maps* on page 2-3, describe the high-level operating blocks and operating cycle of the oscilloscope.
- *User-Interface Map*, on page 2-6, describes the elements of the User Interface (UI) application, which provides complete control of the oscilloscope.
- *Front-Panel Map*, on page 2-7, describes the elements of the oscilloscope front panel and cross references information relevant to each element.
- *Display Map*, on page 2-8, describes elements and operation of single-graticule and multiple-graticule displays.
- *Front Panel I/O Map*, on page 2-9, describes input/output ports and peripherals.

Tutorial procedures are available online, as part of the online help.

For information on configuring and installing your oscilloscope, refer to Chapter 1, *Getting Started*.

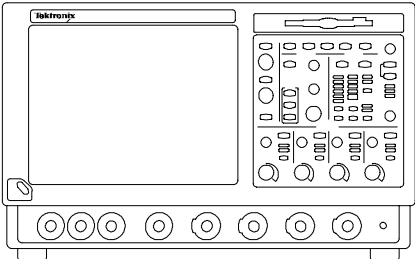
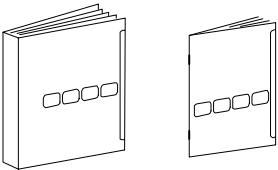
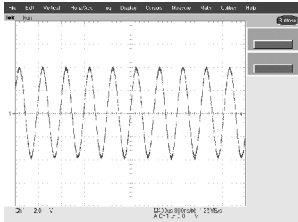
Documentation Map

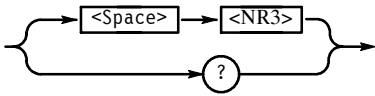
This oscilloscope ships with documents individually tailored to address different aspects or parts of the product features and interface. The table below cross references each document to the oscilloscope features and interfaces it supports.

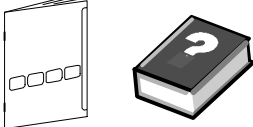
To read about...	Refer to these documents:	Description
Installation, Specification, & Operation (overviews) 	User Manual Reference Manual 	<p>Read the <i>Reference</i> for a quick overview of oscilloscope features and their usage.</p> <p>Read the <i>User Manual</i> for general information about your oscilloscope - procedures on how to put it into service, specifications of its performance, maps of its user interface controls, overviews and background on its features.</p> <p>For more usage information, see <i>Online Help System</i>, below.</p>
In Depth Operation and UI Help 	Online Help System 	<p>Access online help from the oscilloscope for context-sensitive information on virtually all controls and elements on screen.</p> <p>Online help includes procedures for using oscilloscope functions. See <i>Accessing the Online Help System</i> on page 3-245.</p>
GPIO Commands 	Online Programmers Guide 	<p>Quickly remind yourself of the syntax of a command, and copy the command if desired. Read about communication, error handling, and other information on GPIO usage. This guide is on the product software CD.</p>
Analysis and Connectivity Tools	Oscilloscope Analysis and Connectivity Made Easy TekVISA Programming Manual 	<p>TekVISA consists of various connectivity and analysis tools that you can install and configure for your instrument. For more information, see the <i>Analysis and Connectivity Support</i> topic in the instrument online help.</p>

You may also want to obtain the optional service manual for this product if you self-service or performance test this oscilloscope. See *Accessories & Options* on page 1-29.

System Overview Maps

The oscilloscope is a highly capable waveform acquisition, test, and measurement system. The following model provides background information on its operation, which, in turn, may provide you insight on how the oscilloscope can be used.

Functional Model Map

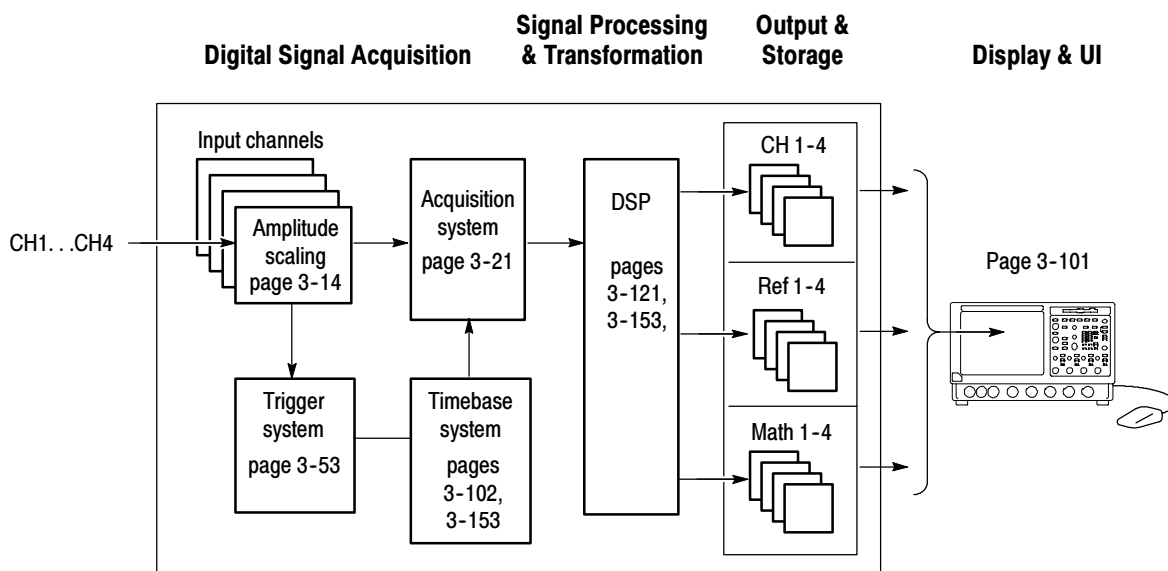

The model comprises four high-level subsystems or processes (embodying a variety of hardware and software functions) and the “data” that connects them:

- **Digital Signal Acquisition System.** Acquires a waveform record from each signal you input to each channel using the following subsystems:
 - **Input Channels.** Conditions the input signal, primarily through the use of analog hardware, before the signal is converted to digital form.
 - **Trigger System.** Recognizes a specific event of interest on the input trigger signal and informs the Timebase of the trigger event’s occurrence.
 - **Timebase System.** Tells the Acquisition system to start an acquisition cycle (i.e. convert from analog to digital). In more general terms,

synchronizes the capturing of digital samples in the Acquisition system to the trigger events generated from the Trigger system.

- **Acquisition System.** Performs the actual A/D conversion and storing of digital samples.
- **DSP Transformation System.** Performs a variety of transformations or operations, beginning with the most fundamental data element(s) in the system, the Channel Waveform(s). Waveform math operations, automatic measurements, spectral waveforms, and histogram generation are examples.
- **Input/Output Systems.** Provides output (and sometimes input) of oscilloscope-data elements in a form suitable to the user and also provides user input control.

The process overview that follows describes each step in the top-level cycle of oscilloscope operation.

Process Overview Map

Process Overview	Process Block Description
<pre> graph TD Idling[Idling...] --> Setup[Implement setup] Setup --> Pretrigger[Acquire pretrigger points] Pretrigger --> Trigger{Trigger accepted?} Trigger -- No --> Pretrigger Trigger -- Yes --> Posttrigger[Acquire posttrigger points] Posttrigger --> Complete{Waveform record complete?} Complete -- No --> Posttrigger Complete -- Yes --> Available[Waveform available] Available --> Stop{Stop condition?} Stop -- Yes --> Idling Stop -- No --> Pretrigger </pre>	<ol style="list-style-type: none"> 1. The oscilloscope starts in the idle state; it enters this state upon power up, upon receiving most control setting changes, or upon finishing acquisition tasks. 2. Control settings are implemented as they are requested. When you toggle the RUN/STOP control to RUN, the oscilloscope starts the hardware. 3. The oscilloscope acquires samples until the pretrigger portion of the waveform record (channel) being acquired is filled. 4. The oscilloscope then begins waiting for a trigger. Acquiring continues to take place, keeping the pretrigger points current, until triggering criteria are met or a trigger is forced (Auto trigger mode only). oscilloscope accepts trigger. 5. The oscilloscope acquires samples until the posttrigger portion of the waveform record (channel) being acquired is filled. 6. If averaging, enveloping, or waveform database is on, the record becomes part of the multi-acquisition record that these modes produce. The process loops back to step 3 above to acquire additional records until the number of acquisitions required for the acquisition mode currently set are processed, and then processing continues to step 7 below. 7. At this point the acquisition record is in DSP memory and is available to the oscilloscope for measurement of its parameters, display, and so on. <p>The oscilloscope then checks for a user-specified stop condition and either returns to its idle state or continues at step 3, according to what it finds.</p>

User Interface Map - Complete Control and Display

Menu Bar: Access to data I/O, printing, online help system, and oscilloscope functions here

Status Bar: Display of acquisition status, mode, and number of acquisitions; trigger status; date; and time

Buttons/Menu: Touch to toggle between tool-bar and menu-bar modes

Multipurpose Knob Readouts: Adjust parameters controlled by multipurpose knobs

Readouts: Display cursor readouts and measurement readouts in this area, selectable from the menu bar or tool bar

Display: Live, reference, & math waveforms display here, along with cursors

Waveform Handle: Touch and drag to change vertical position of waveform. Touch the handle and change the position and scale using the multipurpose knobs

Controls Status: Quick reference to vertical, horizontal, and trigger selections, scale, and parameters

If a control menu is displayed, these readouts move to the graticule area

Front Panel Map - Quick Access to Most Often Used Features

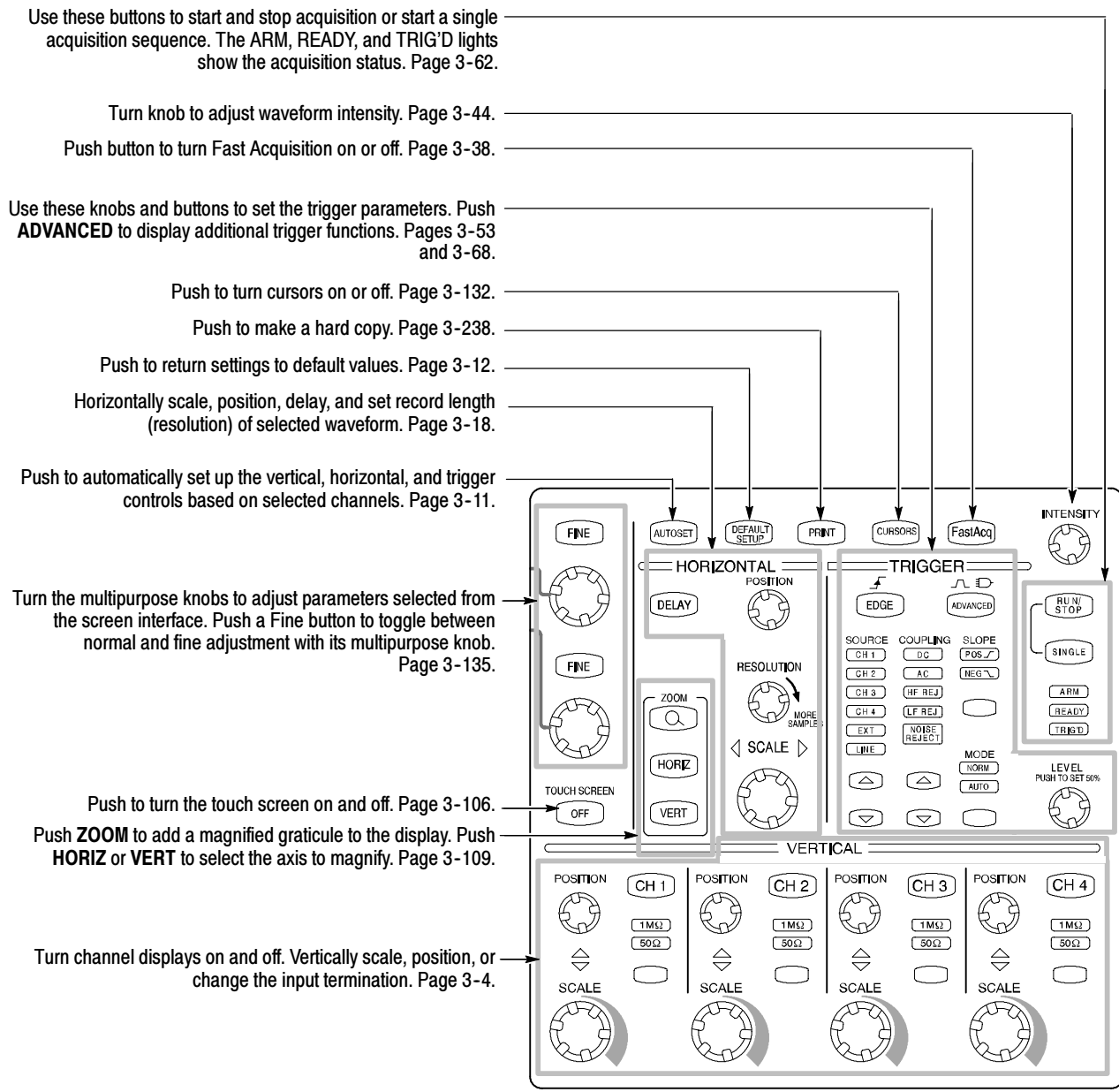

Display Map - Single Graticule

The image shows a screenshot of a Tektronix oscilloscope interface with several annotations and a context menu. The interface includes a top menu bar with buttons for Vert, Horiz, Trig, Disp, Cursors, Meas, Math, Setups, Fets, and Help. Below the menu bar is a status bar with 'Tek Run Sample' and a date/time display '23 Mar 00 16:49:57'. The main display area shows a single sine wave on a grid. A rectangular box highlights a portion of the waveform. A context menu is open over this box, listing options: Zoom 50/50%, Zoom 00/20%, Zoom 100%, Histogram Vertical, Histogram Horizontal, Measurement Gating Cursor, Measurement Gating Zoom, Zoom Off, Histogram Off, Measurement Gating Off, and Cancel. On the right side, there is a panel with 'Curs1 Pos' (-113.6µs), 'Curs2 Pos' (99.2µs), and measurement statistics: T1: 113.6µs, T2: 93.2µs, ΔT: 212.9µs, 1/ΔT: 4.699KHz. A 'Menu' button is also present.

Drag icon to change the trigger level

Drag cursors to measure waveforms on screen

Drag the position icons to reposition a waveform

Click icon to assign multipurpose knobs to waveform vertical position and scale

Drag across the waveform area to zoom the boxed waveform segment to full screen width. Also enable/disable histograms and measurement gating

Zoom 50/50%
Zoom 00/20%
Zoom 100%
Histogram Vertical
Histogram Horizontal
Measurement Gating Cursor
Measurement Gating Zoom
Zoom Off
Histogram Off
Measurement Gating Off
Cancel

Front Panel I/O Map

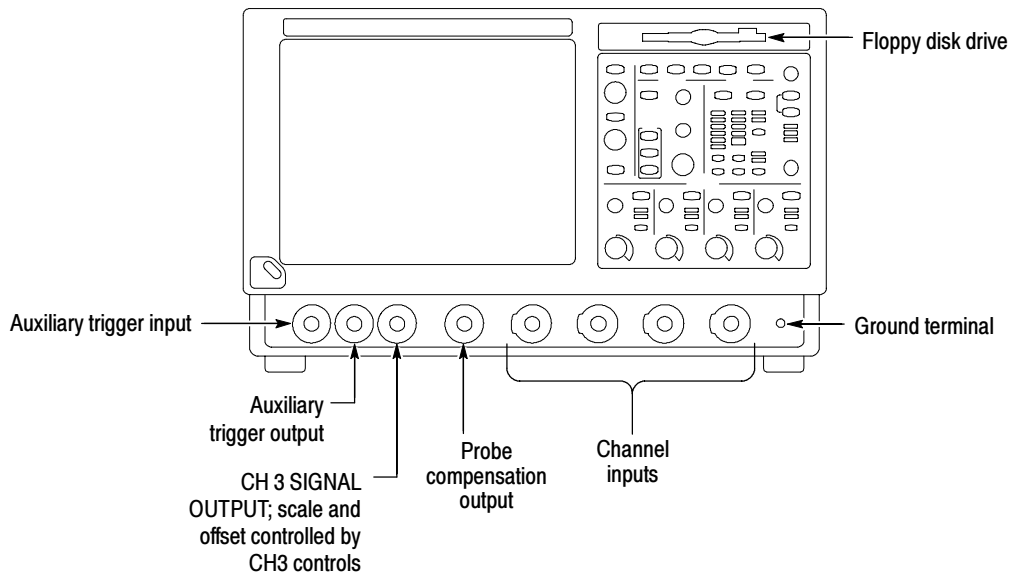

Rear Panel I/O Map

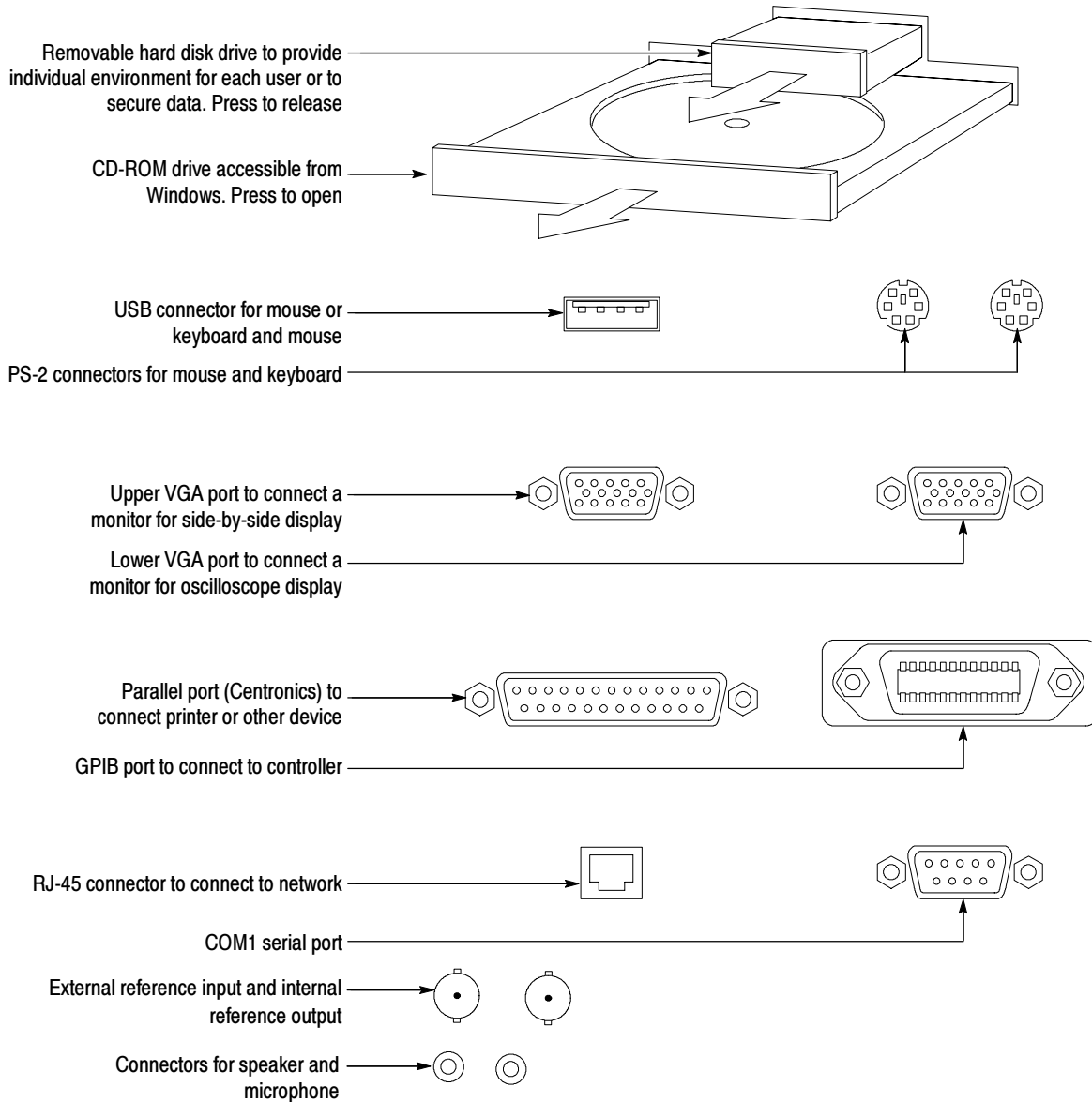

Overview

This chapter describes in depth how the many features of the TDS7000 Series Digital Phosphor Oscilloscopes operate. Please note the following points on using this chapter;

- Each section in this chapter provides background information needed to operate your oscilloscope effectively as well as the higher-level procedures for accessing and using the features. These procedures emphasize using the front panel when possible.
- Lower-level, detailed usage procedures are in the online help system.

The table that follows on page 3-1 lists operating tasks and the sections in this chapter that document those tasks.

Tasks or topics	Subtasks or subtopics	Section title	Contents	Page no.
Signal Input	Acquiring waveforms	<i>Acquiring Waveforms</i>	Overview of section contents	3-3
		<i>Signal Connection and Conditioning</i>	Overview of signal connection and conditioning techniques and setups	3-4
		<i>To Autoset the Oscilloscope</i>	Automatic setup of the acquisition, triggering systems and input channels	3-11
		<i>Input Conditioning Background</i>	Background information on input signal conditioning	3-13
		<i>Setting Acquisition Controls</i>	Background and setup of acquisition controls and roll mode	3-21
		<i>To Set Acquisition Modes</i>	Set up of the acquisition system	3-27
		<i>Acquisition Control Background</i>	Background information on acquisition controls	3-32
		Using Fast Acquisition Mode	Overview and setup of Fast Acquisition mode	3-38
		Using FastFrame [™]	Overview and setup of FastFrame	3-46
	Triggering waveforms	<i>Triggering</i>	Background on basic trigger operation	3-53
		<i>Triggering From the Front Panel</i>	Using the front-panel edge trigger controls	3-58
		<i>Advanced Triggering</i>	Overview and setup for triggering on specific pulse and logic conditions	3-68
		<i>Sequential Triggering</i>	Overview and setup for triggering after time delay and triggering on events	3-92

Tasks or topics	Subtasks or subtopics	Section title	Contents	Page no.
Display Features	Using the Display	<i>Displaying Waveforms</i>	Using display features and customizing the display	3-101
		<i>Using the Waveform Display</i>	Overview of display features and setup of the display	3-102
		<i>Setting Zoom Controls</i>	Overview and use of Zoom	3-109
		<i>Customizing the Display</i>	Customizing display elements	3-114
Data Processing (Calculation)	Taking Measurements	<i>Measuring Waveforms</i>	Setup for measuring parameters	3-121
		<i>Taking Automatic Measurements</i>	Overview and setup for taking automatic measurements	3-122
		<i>Taking Cursor Measurements</i>	Overview and setup for taking cursor measurements	3-132
		<i>Taking Histograms</i>	Overview and setup for taking Histograms	3-138
		<i>Optimizing Measurement Accuracy</i>	Increase accuracy by compensating the oscilloscope and adjusting deskew	3-141
	Math (+, -, /, *, Intg, Diff, Average, Invert, Sqrt, Log 10, Log e, Exp, Magnitude, Real, Phase, and Imag)	<i>Creating and Using Math Waveforms</i>	Functions for processing waveforms, extracting segments of waveforms, etc.	3-153
Spectral Math operations	<i>Defining Spectral Math Waveforms</i>	Functions for frequency domain analysis of your waveforms.	3-168	
Optimizing Measurement Accuracy	Oscilloscope compensation and compensation or calibration of probes	<i>Optimizing Measurement Accuracy</i>	Procedures for compensating the oscilloscope, compensating passive probes, and calibrating active, voltage probes	3-141
Data Input and Output	All uploading and downloading of waveforms, calculation results, and other data	<i>Data Input/Output</i>	Primary reference for uploading and downloading of any data to or from the oscilloscope	3-205
		<i>Saving and Recalling a Setup</i>	Background and setup for saving and recalling setups	3-205
		<i>Saving and Recalling Waveforms</i>	Background and setup for saving and recalling waveforms	3-213
		<i>To Clear References</i>	Setup to clear references	3-220
		<i>Exporting and Copying Waveforms</i>	Background and setup for exporting waveforms and using exported waveforms	3-223
		<i>Printing Waveforms</i>	Background and setup for printing waveforms	3-238
		<i>To Date/Time Stamp Hardcopies</i>	Background and setup to display the date and time	3-242
Remote Communication	GPIB	<i>Remote Communication</i>	Information on programming the oscilloscope over the GPIB	3-243
Help	Using Online Help	<i>Accessing Online Help</i>	Information on accessing the information in the online help	3-245

Acquiring Waveforms

Before you can do anything (display, print, measure, analyze, or otherwise process) to a waveform, you must acquire the signal. This oscilloscope comes equipped with the features you need for capturing your waveforms before further processing them according to your requirements. The following topics cover capturing signals and digitizing them into waveform records:

- *Signal Connection and Conditioning:* How to connect waveforms to the oscilloscope channels; how to scale and position the channels and timebase for acquiring waveforms.
- *Setting Acquisition Controls:* How to choose the appropriate acquisition mode for acquiring your waveforms; how to start and stop acquisition.
- *Acquisition Control Background:* Background information on the data sampling and acquisition process.
- *Using Fast Acquisition Mode:* Using Fast Acquisition mode to capture and display transient events, such as glitches or runt pulses, often missed during longer dead times that accompany normal DSO operation.
- *Using FastFrame:* Using FastFrame to capture many records in a larger record, and then view and measure each record individually.

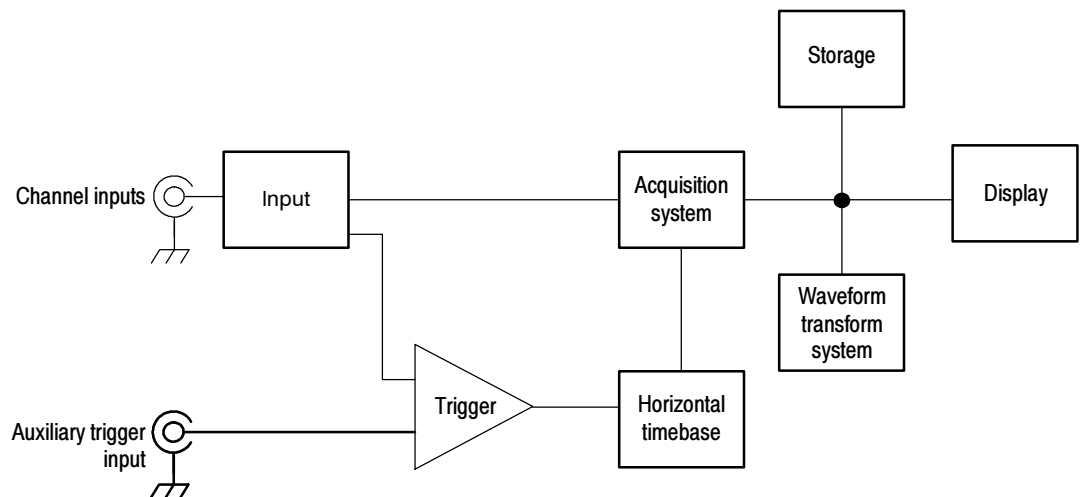

NOTE. This section describes how the vertical and horizontal controls define the acquisition of live, waveforms. These controls also define how all waveforms are displayed, both live and derived waveforms (math waveforms, reference waveforms, and so on). The sections that follow cover display-related usage:

- Displaying Waveforms on page 3-101.
- Creating and Using Math Waveforms on page 3-153.

Signal Connection and Conditioning

This section overviews the oscilloscope features related to setting up the input signal for digitizing and acquisition. It addresses the following topics:

- How to turn on channels and adjust vertical scale, position, and offset
- How to set horizontal scale, position, and access record-length and trigger-position controls
- How to get a basic trigger on your waveform

NOTE. Terminology: This manual uses the terms vertical acquisition window and horizontal acquisition window throughout this section and elsewhere. These terms refer to the vertical and horizontal range of the segment of the input signal that the acquisition system acquires. The terms do not refer to any windows or display windows on screen.

Figure 3-1 shows the model for each input channel.

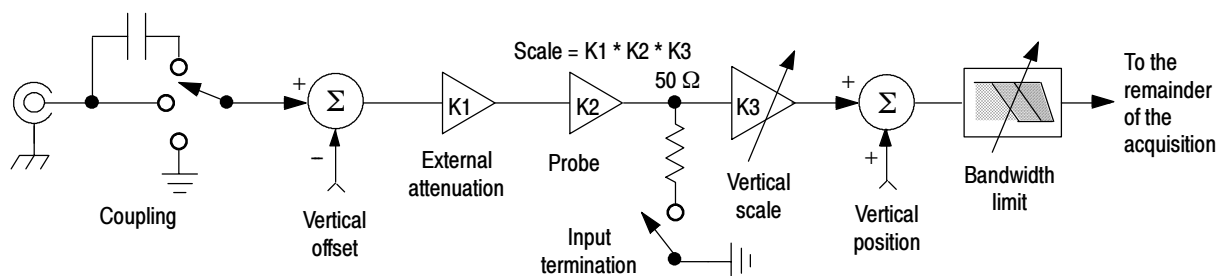

Figure 3- 1: Input & Acquisition Systems & Controls

Use input conditioning to ensure the oscilloscope acquires the data that you want to display, measure, or otherwise process. To ensure the best possible data for displaying and further processing, you do the following;

- Set the vertical scale to control the size of the vertical acquisition window for each channel in order to capture part or all of the vertical amplitude of the input signal. When vertical scaling is set to capture only a fraction of the input signal range (for increased detail), the vertical offset control may be used to determine which portion of the input signal is captured by the vertical acquisition window.
- Set horizontal scale to control the size of the horizontal acquisition window in order to capture as much as you want of the input signal(s). Set the horizontal position to delay the window relative to a trigger and to control where in the input signal (data stream) that the horizontal acquisition window acquires.

For more background on acquisition window concepts, see *Input Conditioning Background* on page 3-13.

The oscilloscope can automatically obtain and display a stable waveform of usable size. Pushing the Autoset button automatically sets up the oscilloscope controls based on the characteristics of the input signal. Autoset is much faster and easier than a manual control-by-control setup.

The oscilloscope can also be reset to its factory default settings.

Usage of some input conditioning controls or features may be limited when other control settings are in effect. Voltage offset is incompatible with reference waveforms because offset is an acquisition control.

Connecting and Conditioning Your Signals

Read the following topics related to waveform acquisition; they provide details that can make it easier to set up and acquire your waveforms.

Probes and Signal Connection. Select the probe or cable that brings the signal into the oscilloscope. Choose the probe or cable that best fits your acquisition task, whether it's connecting an active probe to test a digital circuit, or connecting to a test fixture through BNC cables to characterize a device. The connection to the oscilloscope depends on your application.

Tektronix provides a variety of probes and cables for this product. For a list of probes available for use, see *Accessories and Options* on page 1-29. You can also check your Tektronix catalog for connection accessories that may support your application. More information about your probes can be found in your probes user manual.

Up to 4 acquisition channels are available. Each channel can be displayed as a waveform or can contribute waveform data to other waveforms (math and reference waveforms for example).

Coupling. All oscilloscopes and probes specify a maximum signal level. (See *Specifications* in your User manuals for exact limits.) Do not exceed the limit, even momentarily, as the input channel may be damaged. Use external attenuators if necessary to prevent exceeding the limits.

Coupling determines whether an input signal is directly connected to the input channel, connected through a DC blocking capacitor, or not connected at all. These three choices are referred to as DC coupling, AC coupling, and GND coupling.

The input resistance of each input channel is 1 M Ω . To properly terminate signals when using coaxial cables, or to support active probes designed for a 50 Ω environment, a 50 Ω termination resistance can be switched in parallel with the 1 M Ω input.

All probes expect a specific coupling and input termination. Both coupling and input termination resistance are displayed on screen. If the oscilloscope determines the coupling and termination required by the probe, either implicitly because of the TekProbe interface or through performing a probe calibration, the oscilloscope sets the required coupling and input termination.

Consider the following points when you use 50 Ω coupling with any channel:

- The oscilloscope does not accurately display frequencies under 200 kHz if AC coupling is selected.
- The oscilloscope reduces the maximum volts per division setting for the channel to 1 V from 10 V (to 10 V from 100 V with a X10 probe attached), since input amplitudes appropriate for the higher settings would overload the 50 Ω input.
- The oscilloscope switches to 50 Ω and DC coupling if you connect an active probe, such as the P6245 probe. Such probes also reduce the maximum volts per division.

Scaling and Positioning. These key controls determine the portion of the input signal presented to the acquisition system:

- Set vertical scaling, positioning, and DC offsets to display the features of interest on your waveform and avoid clipping. (See *Note* that follows.) *Vertical Acquisition Window Considerations* on page 3-14 describes the vertical acquisition window.

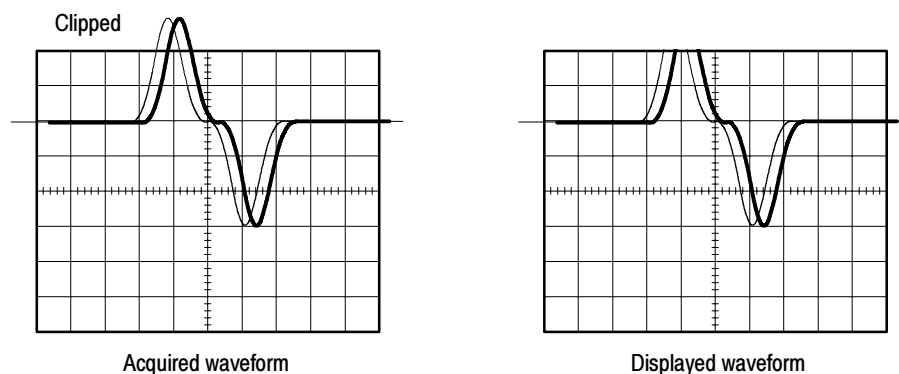

- Set horizontal scale, position, and resolution (record length) so that the acquired waveform record includes the waveform attributes of interest with good sampling density on the waveform. The settings you make define the horizontal acquisition window, described in *Horizontal Acquisition Window Considerations* on page 3-18.

NOTE. *Waveform data outside the vertical acquisition window is clipped; that is, the data is limited to the minimum or maximum boundaries of the vertical acquisition window. This limiting causes inaccuracies in amplitude-related measurements. See Vertical Acquisition Window Considerations on page 3-14.*

Trigger and Display. Set basic trigger controls to gate waveform acquisition, and use the display to interactively scale, position, and offset waveforms. See the sections *Triggering* on page 3-53 and *Displaying Waveforms* on page 3-101.



Flexible Control Access. This manual focuses on basic setup through the front panel, and then through use of the User Interface (UI) Application displayed on screen. The online help system also documents the UI.

To Set Up Signal Input

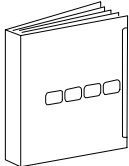
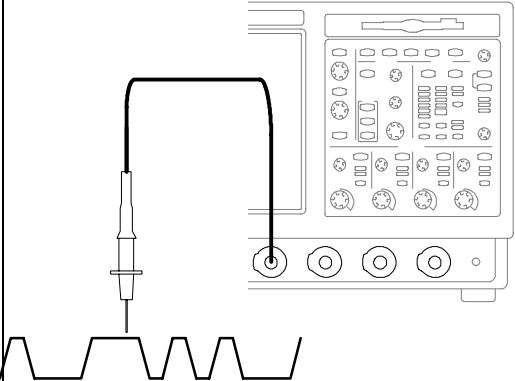
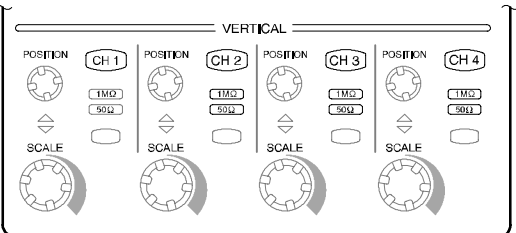
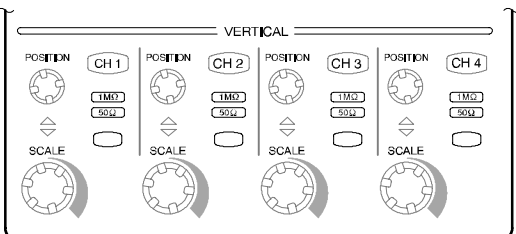
Use the procedure that follows when setting up the oscilloscope to scale and position input signals for acquisition. For more information, display online help while performing the procedure.

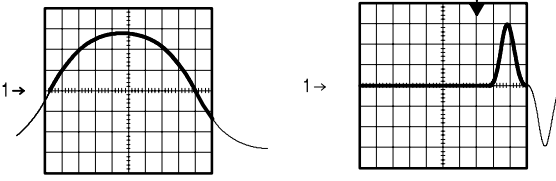
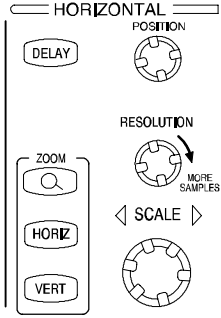

Overview	To set up signal input	Related control elements & resources
<p>Prerequisites</p>	<p>1. The acquisition system should be set to run continuously.</p>	 <p>See page page 3-27 for acquisition setup & page 3-53 for trigger setup.</p>
<p>Connect input signal</p>	<p>2. Connect to the signal to be acquired using proper probing/connecting techniques.</p> <p>Note: For more details on control over input setup, push the Vert button to display the Vertical control window, and then touch the HELP button.</p>	
<p>Select the input signal channel</p>	<p>3. Push a channel button (CH 1-CH 4) to select the signal channel.</p> <p>A channel button lights when its channel is on.</p>	
<p>Select input termination</p>	<p>4. Push an input termination button to toggle between 1 MΩ and 50 Ω input termination.</p> <p>Hint. Some probes force the oscilloscope to set the termination that the probe requires.</p>	

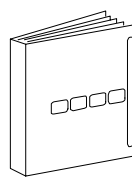
Overview	To set up signal input	Related control elements & resources
<p>Select input coupling</p>	<p>5. Touch Vert to display the Vertical control window. To change the input coupling, select the channel tab and then select from:</p> <ul style="list-style-type: none"> ■ <i>DC</i> to couple both the AC and DC components of an input signal ■ <i>AC</i> to couple only the AC components of an input signal ■ <i>GND</i> to disconnect the input signal from the acquisition <p>Touch Close to close the window.</p>	
<p>Set vertical acquisition window</p>	<p>6. Use the vertical knobs to scale and position the waveform on screen.</p> <div style="display: flex; justify-content: space-around;"> <div style="text-align: center;"> <p>Positioned vertically</p> </div> <div style="text-align: center;"> <p>Scaled vertically</p> </div> </div> <p>Dragging the waveform handle also positions the waveform.</p> <p>7. Touch Vert to display the Vertical control window. To change the offset, touch the Offset control and turn the multipurpose knob to adjust the offset.</p>	

Overview	To set up signal input	Related control elements & resources
<p>Set horizontal acquisition window</p>	<p>8. Use horizontal knobs to scale and position the waveform on screen and to set record length.</p> <p>Dragging the reference icon also positions the waveform.</p>  <p>Scaled horizontally Positioned horizontally</p> <p>The Resolution knob sets the record length. (See discussion on page 3-19.)</p> <p>If required to stabilize the display, push LEVEL to set the trigger level to 50%.</p>	
<p>For help</p>	<p>9. For more information on the controls described in this procedure, push the Vert or Horiz button. Touch the HELP button in the tool bar.</p>	
<p>Continue with acquisition setup</p>	<p>10. To finish acquisition setup, you must set the acquisition mode and start the acquisition.</p>	 <p>See <i>To Set Acquisition Modes</i> on page 3-27.</p>

To Autose the Oscilloscope

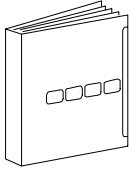
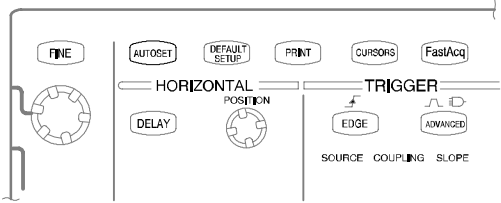
Autoset automatically sets up the oscilloscope controls (*acquisition, display, horizontal, trigger, and vertical*) based on the characteristics of the input signal. Autoset is much faster and easier than a manual control-by-control setup. When the input signal is connected, do an autoset to automatically set up the oscilloscope:

Overview	To autose the oscilloscope	Control elements & resources
<p>Prerequisites</p>	<p>1. Signals must be connected to channels. A triggering source must be provided.</p>	 <p>See page 3-53 in this manual for trigger setup information.</p>
<p>Execute</p>	<p>2. Push the Autoset button to execute an Autoset.</p> <p>If you use Autoset when one or more channels are displayed, the oscilloscope selects the lowest numbered channel for horizontal scaling and triggering. All channels in use are individually vertically scaled.</p> <p>If you use Autoset when no channels are displayed, the oscilloscope turns on channel one (CH 1) and scales it.</p>	
<p>Execute Autoset Undo</p>	<p>3. The Autoset Undo control window opens automatically after an Autoset operation. Click Undo if you want to undo the last Autoset.</p> <p>Only the parameters that were set by the last Autoset are undone. Parameters that you changed that are not controlled by Autoset retain their settings.</p> <p>If you don't want this window to appear, set the Utilities/User Preferences/Autoset Undo button to Off. You can still do an Autoset Undo using the Horiz/Acq menu.</p>	

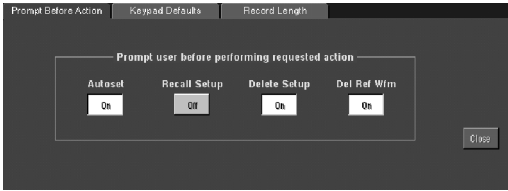
Overview	To autoset the oscilloscope	Control elements & resources
<p>Prompt</p> <p>Done</p>	<p>4. Select User Preferences in the Utilities menu to display the Prompt Before Action window. Touch Autoset to toggle between ON and OFF:</p> <ul style="list-style-type: none"> ■ OFF to setup for performing an autoset when the AUTOSET button is pushed ■ ON to set up for displaying a prompt before performing an autoset when the AUTOSET button is pushed <p>Touch Close to save your prompt selection.</p>	

NOTE. Autoset may change vertical position in order to position the waveform appropriately. It always sets vertical offset to 0 V.

To Reset the Oscilloscope

You may want to revert to the factory default setup; if so, reset the oscilloscope:

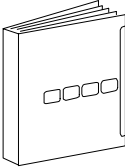
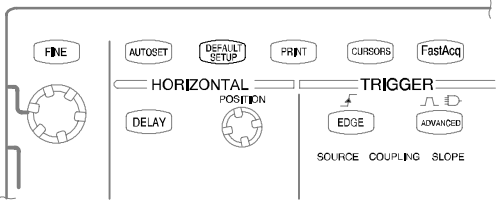
Overview	To reset the oscilloscope	Control elements & resources
<p>Prerequisites</p>	<p>1. The oscilloscope is powered up and running.</p>	 <p>See <i>Powering On Oscilloscope</i> on page 1-8.</p>
<p>Execute</p>	<p>2. Push the DEFAULT SETUP button.</p>	

To Get More Help You can get help on the vertical and acquisition controls by accessing online help:

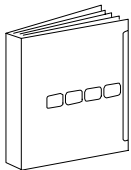
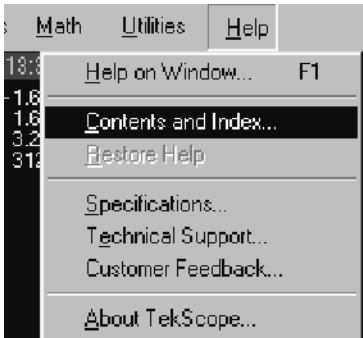
Overview	To get more help	Control elements & resources
Prerequisites	1. Oscilloscope powered up and running.	 <p>See <i>Powering On Oscilloscope</i> on page 1-8.</p>
Access vertical set up help	2. Touch the Help button in tool bar mode or select Help on Window from the Help menu in menu bar mode. 3. You can also select topics related to the vertical controls from the online help Contents/Index/Find window: select Contents and Index in the Help menu, as shown at right.	

Input Conditioning Background

This section contains background information that can help you more effectively set up the acquisition window of each channel.

Input. Keep in mind this oscilloscope samples in real-time or random equivalent-time; both sampling systems provide pre-trigger information by using the trigger to stop an already running acquisition. Both sampling systems also sample the input after it is scaled, providing improved input protection and dynamic range.



CAUTION. Do not overdrive the inputs and observe static-safe procedures

Autoset Considerations. Autoset acquires samples from the input signal and attempts to take the following actions based on the input data:

- Evaluate the amplitude range of the input signals and set the size and vertical offset of the vertical acquisition window to acquire the signal with good resolution, but without clipping.
- Set the trigger to the approximate midlevel of the signal being autoset and switches to edge trigger mode.

- Evaluate the signal transitions and set the horizontal scale to produce a waveform display of 2 or 3 cycles of the input signal.

Sometimes Autoset cannot produce a correct display due to the nature of the input signal; if so, you may have to adjust the scale, trigger, and acquisition controls manually. Some conditions that can cause Autoset to fail are:

- No signal present
- Signals with extreme or variable duty cycles
- Signals with multiple or unstable signal periods
- Signals with too low amplitude
- No recognizable trigger signal
- Signals with a frequency < 20 Hz
- Signals with a frequency above the bandwidth of the oscilloscope

Vertical Acquisition Window Considerations. You can set the vertical size, position, and offset of each channel independently of other channels. Vertical scale and offset specify the vertical acquisition window for each channel. Parts of the signal amplitude that fall within the vertical window are acquired; parts outside (if any) are not.

The offset control subtracts a constant DC level from the input signal before the vertical scale factor is applied, and the vertical position control adds a constant number of divisions of signal after the scale factor is applied to the resulting difference.

The vertical scale and position controls have the following effects on the vertical acquisition window and the displayed waveform:

- The vertical volts per division you set determines the vertical size of the acquisition window, allowing you to scale it to contain all of a waveform amplitude or only part. Figure 3-2 on page 3-16 shows two vertical acquisition windows that contain the entire waveform, but only one window contains the entire waveform in the graticule on screen.

NOTE. *Amplitude-related automatic measurements (for example, peak-to-peak and RMS) will be accurate for vertical windows like those shown in Figure 3-1a and b because neither waveform is clipped (that is, both waveforms are acquired). But if signal amplitude were to extend outside the vertical acquisition window, the data acquired is clipped. Clipped data causes inaccurate results if used in amplitude-related automatic measurements. Clipping also causes inaccurate amplitude values in waveforms that are stored or exported for use in other programs.*

If the scale of a math waveform is changed so that the math waveform is clipped, it will not affect amplitude measurements on that math waveform.

- The vertical position adjusts the display of the graticule relative to the vertical acquisition window (position is a display control). Figure 3-2b shows how vertical position moves the waveform graticule vertically in the acquisition window to place the acquired waveform in the graticule display. That is all position does; it does not determine what data is acquired as do vertical scale and offset.

- a. **SCALE setting determines the vertical acquisition window size; here 100 mV/div x 20 divisions (10 graticule divisions and ± 5 divisions of position)**

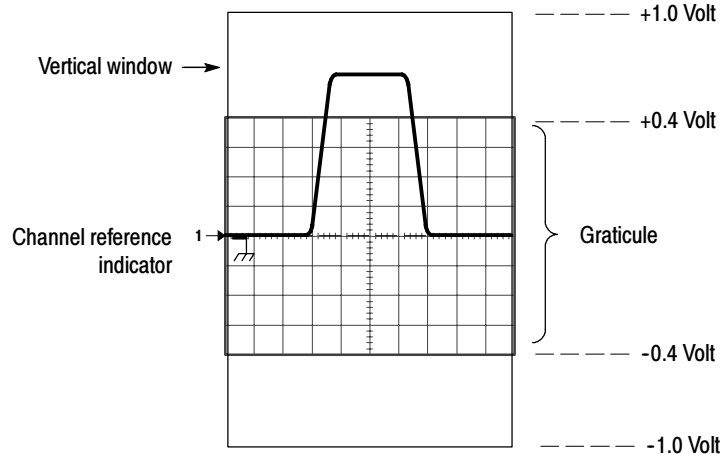

- b. **Vertical position can change the location of the display graticule within the acquisition window, repositioning it so its waveform appears in the graticule**

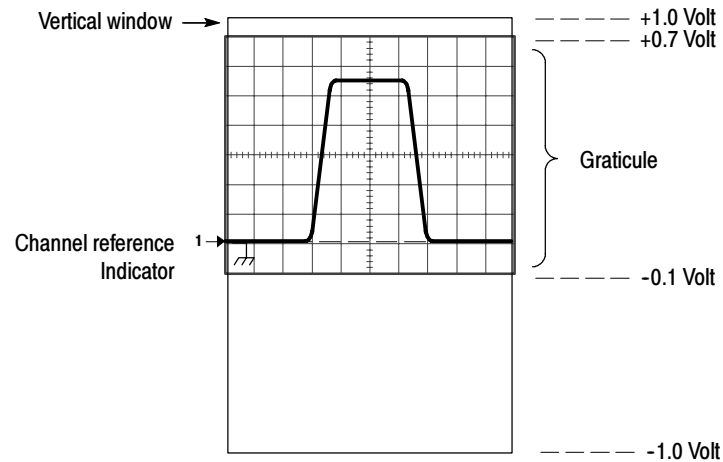

Figure 3-2: Setting vertical range and position of input channels

The vertical offset control affects the vertical acquisition window and the displayed waveform as follows:

- The vertical range (window) is always centered around the offset value. It is the voltage level at the middle of the vertical acquisition window. With no (zero) offset, as shown in Figure 3-2 a and b, that voltage level is zero (ground).

- As you vary vertical offset, the middle voltage level moves relative to zero. This moves the vertical acquisition window up and down on the waveform. With input signals that are smaller than the window, it appears the waveform moves in the window. Actually, a larger signal shows what really happens: the offset moves the middle of the vertical acquisition window up and down on the input signal. Figure 3-3 shows how offset moves the acquisition window to control the portion of the waveform amplitude the window captures.
- Applying a negative offset set moves the vertical range down relative to the DC level of the input signal. Likewise, applying a positive offset moves the vertical range up. See Figure 3-3.

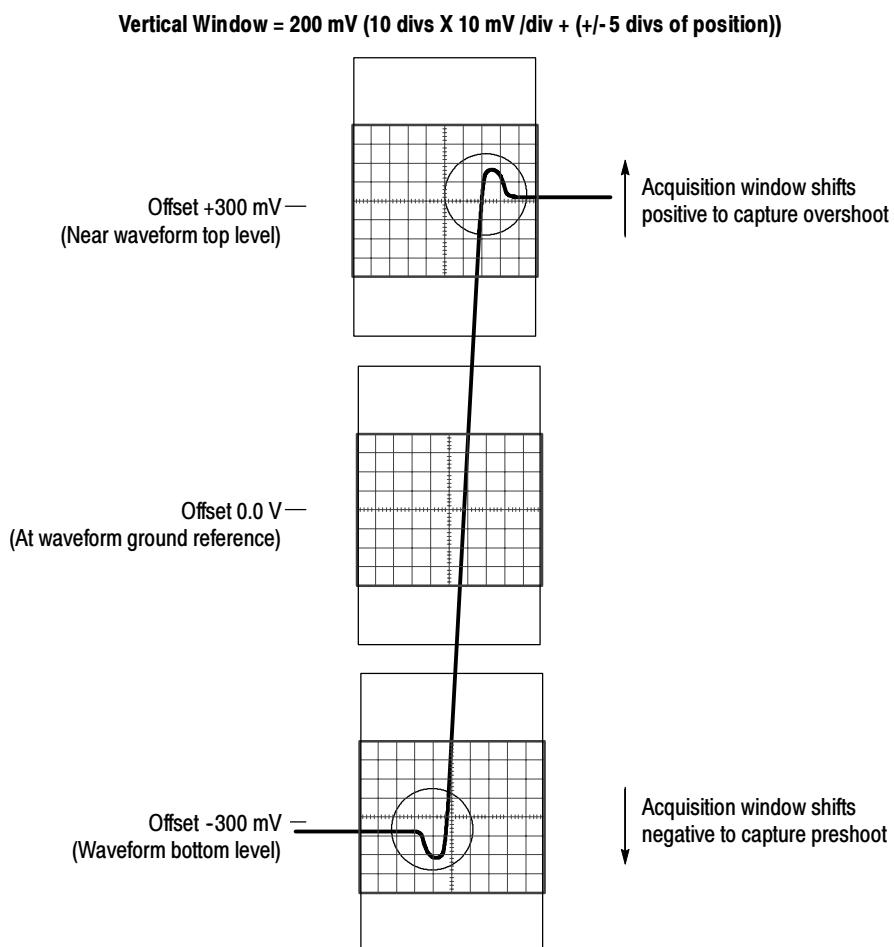

Figure 3-3: Varying offset moves the vertical acquisition window on the waveform

Horizontal Acquisition Window Considerations. The oscilloscope lets you define the horizontal acquisition window, that is, set several parameters that determine the segment of an incoming signal that becomes the waveform record when acquired. (For background, please read *Waveform Record* on page 3-34.) These common parameters specify a horizontal acquisition window that is applied to all channels in parallel. (See *Independent vs. Shared Window* on page 3-20.) These parameters are:

- The trigger condition you set up determines the point on the waveform that triggers the oscilloscope.
- Horizontal position also determines the number of pretrigger and posttrigger samples; samples before the reference point are pretrigger samples and those after the reference are posttrigger samples.
- The Horizontal Delay you set determines the time from the trigger point to the Horizontal Reference.
- The horizontal scale and waveform record length (number of samples) you set determines the horizontal size of the window relative to any waveform, allowing you to scale it to contain a waveform edge, a cycle, or several cycles.

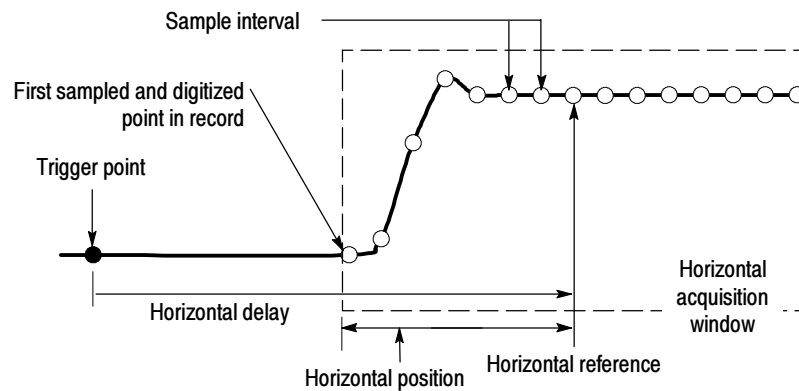

Figure 3-4: Horizontal Acquisition window definition

Horizontal Scale vs. Record Length vs. Sample Interval vs. Resolution. These parameters all relate to each other and specify the horizontal acquisition window. Because the horizontal acquisition window must fit in the 10 horizontal division display, for most cases, you just set the duration of the horizontal acquisition window (10 divs x the scale setting) as described in (1) below. By also setting a record length in samples, you indirectly set the resolution/sample interval/sample rate for the horizontal acquisition window (waveform record). The relationships between these horizontal elements follow:

1. $\text{Time Duration (seconds)} = 10 \text{ divs (window size)} \times \text{Horizontal scale (sec/div)}$
2. $\text{Time Duration (seconds)} = \text{Sample Interval (seconds/sample)} \times \text{Record Length (samples)}$,

where:

Time Duration is the horizontal acquisition window time duration

and:

$\text{Sample Interval (sec/sample)} = \text{Resolution (sec/sample)} = 1/\text{Sample Rate (samples/sec)}$

In (2) above, note that it is Sample Interval that varies to accommodate the window time duration (and its scale setting) and the Record Length setting as these later two elements can be set by you. These elements behave as follows:

- If Record Length or Time Duration vary, Sample Interval varies to accommodate, up to highest sample rate/lowest sample interval/highest resolution.
- If Sample Interval reaches its lower limit, Record Length must decrease if Time Duration decreases (you set faster scale settings), or Time Duration must increase (forcing slower scale settings) if Record Length increases (you set longer record lengths). The equation becomes:

$$\text{Maximum Record Length} = \text{Time Duration} \div \text{Min Sample Interval}$$

For example, at 200 ps/div and 10 divisions, the record length must be 500 points:

$$\text{Max Rec Length 500 samples} = (10 \text{ divs} \times 200 \text{ ps/div}) \div 4 \text{ ps/sample}$$

$$\text{Max Rec Length} = 500 \text{ samples}$$

NOTE. As implied from the operation just described, resolution and the equivalent elements, sample interval and sample rate (see equation 2 above), are not settable directly, but are derived. You can, however, check the resolution at anytime in the resolution readout. Also note, that the Resolution control actually adjusts the record length to increase sample density.

The above discussion also assumes that horizontal scale is held constant. You can, however, choose to hold the sample rate constant instead, by selecting Hold Sample Rate Constant in the Utilities, User Preferences menu.

Independent vs. Shared Window. The oscilloscope applies the same horizontal acquisition window to all channels from which it acquires data. Unlike the vertical acquisition window that you size and offset independently for each channel, the same time/div, resolution (record length), and horizontal position (from the same trigger point) apply to all channels simultaneously. In other words, one trigger, from a single trigger source, will locate a common horizontal acquisition window for all active channels, which you can shift in parallel by setting the horizontal position control.

The horizontal acquisition window determines the waveform records extracted from all signals present at all active channels. You can think of the horizontal acquisition window as cutting across any input signals present in the input channels to extract the same slice of time into waveform records. See Figure 3-5.

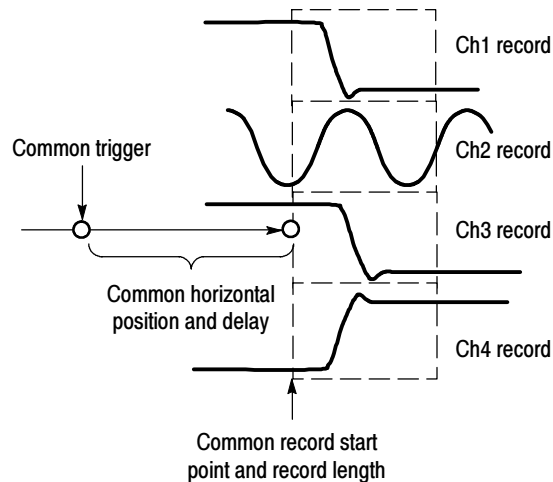
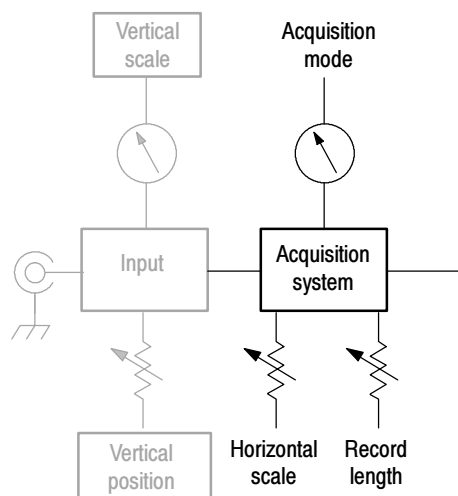

Figure 3-5: Common trigger, record length, and acquisition rate for all channels

Setting Acquisition Controls

This section overviews the oscilloscope acquisition features—those that start and stop acquisitions and those that control how the oscilloscope processes the data as it is acquired (just sampled, or averaged or enveloped). Special features, keys to using, and operation controls are covered.



Roll mode gives a strip chart recorder-like display for low frequency signals. Roll mode lets you see acquired data points without waiting for the acquisition of a complete waveform record. For example, in normal acquisition mode, when the Horizontal Scale is 1 second per division, 10 seconds are required to fill the waveform record. Without roll mode you must wait 10 seconds to see that the position control is set wrong. With roll mode you can start seeing results almost immediately.

The following table indicates which acquisition features and modes are incompatible with other features or modes:

Control/Feature	Incompatible with	Explanation
Voltage Offset	Reference Waveforms (Ref1-Ref4)	Offset is an acquisition control not a display control
Average	Single shot acquisition	Acquisitions continue until the specified number of waveforms have been acquired and averaged

Control/Feature	Incompatible with	Explanation
Envelope	Single shot acquisition	Acquisitions continue until the specified number of waveforms have been acquired for the enveloped waveform
Roll	Measurements	Measurements are not available until you stop acquisitions

Using the Acquisition Controls

Consider the mode you want to use to acquire data:

- *Sample* - the oscilloscope does no post-processing of acquired samples. The oscilloscope saves the first sample (of perhaps many) during each acquisition interval (an acquisition interval is the time covered by the waveform record divided by the record length.) Sample mode is the default mode.
- *Peak Detect* - the oscilloscope alternates between saving the lowest sample in one acquisition interval and the highest sample in the next acquisition interval. This mode only works with real-time, noninterpolated sampling.
- *Hi Res* - the oscilloscope creates a record point by averaging all samples taken during an acquisition interval. Hi Res results in a higher-resolution, lower-bandwidth waveform. This mode only works with real-time, noninterpolated sampling.

A key advantage of Hi Res is its potential for increasing vertical resolution regardless of the input signal. Table 3-1 indicates that you can obtain up to 13 significant bits with Hi res mode. The instrument uses 16-bit memory. This is allocated as 15 bits + 1 sign bit. Round-off errors and internal noise limit the effective bits for Hi Res mode and signal averaging to about 13 bits. You can calculate the theoretical number of bits of enhancement using the following formula where N_d is the number of points acquired during a sample interval:

$$\text{Bit of enhancement} = 0.5 \log_2 * N_d$$

Table 3-1: Additional resolution bits

Sample Rate (S/s)	Nd (extra samples)	Theoretical enhancement (bits)	Resulting effective bits
5.00E+00	2.50E+08	13.95	13.00
1.00E+01	1.25E+08	13.45	13.00
2.50E+01	5.00E+07	12.79	13.00
5.00E+01	2.50E+07	12.29	13.00
1.00E+02	1.25E+07	11.79	13.00
2.50E+02	5.00E+06	11.13	13.00
5.00E+02	2.50E+06	10.63	13.00
1.00E+03	1.25E+06	10.13	13.00
2.50E+03	5.00E+05	9.47	13.00
5.00E+03	2.50E+05	8.97	13.00
1.00E+04	1.25E+05	8.47	13.00
2.50E+04	5.00E+04	7.80	13.00
5.00E+04	2.50E+04	7.30	13.00
1.00E+05	1.25E+04	6.80	12.80
2.50E+05	5.00E+03	6.14	12.14
5.00E+05	2.50E+03	5.64	11.64
1.00E+06	1.25E+03	5.14	11.14
2.50E+06	5.00E+02	4.48	10.48
5.00E+06	2.50E+02	3.98	9.98
1.00E+07	1.25E+02	3.48	9.48
2.50E+07	5.00E+01	2.82	8.82
5.00E+07	2.50E+01	2.32	8.32
1.00E+08	1.25E+01	1.82	7.82
2.50E+08	5.00E+00	1.16	7.16
5.00E+08	2.50E+00	0.66	6.66
1.25E+09	1.00E+00	0.00	6.00

- *Envelope* - Continuously, as subsequent waveforms are acquired, the oscilloscope retains the running minimum (Min) and maximum (Max) values in adjacent sample intervals, creating an envelope of the number of waveforms you specify. Once the specified number of waveforms is reached, the data is cleared and the process starts over. This is similar to the Peak Detect mode, but Envelope mode, unlike Peak Detect, gathers peaks over many trigger events.

- Average** - the oscilloscope processes the number of waveforms you specify into the acquired waveform, creating a running average of the input signal. This mode reduces random noise.

Acquiring and displaying a noisy square wave signal illustrates the difference between the modes. Note how Average reduces the noise while Envelope captures its extremes:

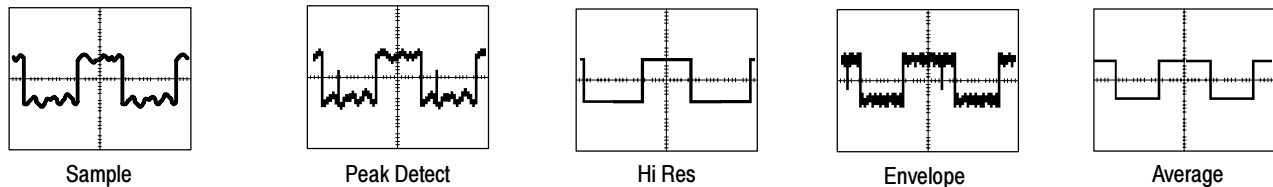

- Waveform Database.** Using waveform database technology, the oscilloscope processes a much larger sample of data. The waveform database is a three-dimensional accumulation of source waveform data over several acquisitions. In addition to amplitude and timing information, the database includes a count of the number of times a specific waveform point (time and amplitude) has been acquired. The database is 200 lines by 500 columns with a 64 bit counter for each pixel location. You can use color-graded displays based on counts to highlight waveform activity. Parametric measurements derived from the database use statistical techniques to produce more stable, accurate results.

If you select Infinite Persistence, the counts accumulate continuously. An infinite waveform data base is required for some Comm measurements.

Samples sets the minimum number of samples required to complete a single acquisition sequence and the minimum number of samples required to complete a mask test. If not using display persistence, the minimum number of samples that is required to release the waveform to the display. Similarly to FastFrame, selecting RunStop, will cause the waveform to be displayed with what has been acquired so far.

The actual number of samples acquired is determined by the Samples setting, the selected Record Length, and if in equivalent time acquisitions, the actual number of samples acquired in an acquisition. For example, in real-time acquisition mode with the entire trace displayed, if the Record Length is set to 5000 points and Samples is set to 5001 points, then two acquisitions are required and 10000 points are acquired. If Samples is set to 5000 points, one acquisition is required and 5000 points are acquired. If Samples is set to 4999 points, one acquisition is required and 5000 points are acquired.

For Single Sequence and Mask Pass/Fail Testing, a sample is only counted if the sample would be displayed in the graticule area. In Single Sequence, all

eligible samples in an acquisition are counted, and in Mask Test, all acquisitions acquired in a batch are counted.

In ET mode, fewer samples are acquired per acquisition, but more acquisitions may be acquired in a batch. Samples divided by the Record Length roughly indicates the number of waveforms in a batch of acquisitions.

Batch processing minimizes the overhead of displaying and processing other features, such as measurements and histograms. The higher the number of samples, the greater the acquisition throughput and the potential for less frequent display updates.

Also, consider how you want to control acquisition; you have two main options, settable from the Run/Stop control window (select Run/Stop from the Horiz/Acq MENU):

- **Run/Stop Button Only** - Sets the oscilloscope to start and stop the acquisition only when you push the Run/Stop button, available on the front panel, or in the Run/Stop control window. If toggled to Run, acquisition will start if a valid trigger occurs. If toggled to Stop, acquisition stops immediately.
- **Single Acquisition** - In addition to the Run/Stop Button, which can always stop acquisition, the SINGLE button (or Single Sequence control) will automatically stop acquisition when one complete acquisition sequence is completed. See step 4, *Set the Stop Mode*, on page 3-28, or access the online help from the Run/Stop control window for more information.

Untriggered Roll. Untriggered roll mode displays newly acquired data points at the right edge of the waveform record while moving older waveform data points to the left. To stop acquiring data push **RUN/STOP** (see Figure 3-6).

Use untriggered roll to continuously observe a slow process, knowing that you can always see the most recent view of that process. Math and measurements work after you push STOP.

Untriggered Roll with Single Sequence. Untriggered roll mode with single sequence displays newly acquired data points at the right edge of the waveform record while moving older waveform data points to the left. Acquisitions automatically stop after a complete waveform record is acquired (see Figure 3-6).

Use untriggered roll with single sequence to observe data for later viewing. For example, at 20 seconds per division and 30K record length there are 12000 seconds of acquired data points. Untriggered roll with single sequence would capture data over a lunch hour and hold it for later viewing.

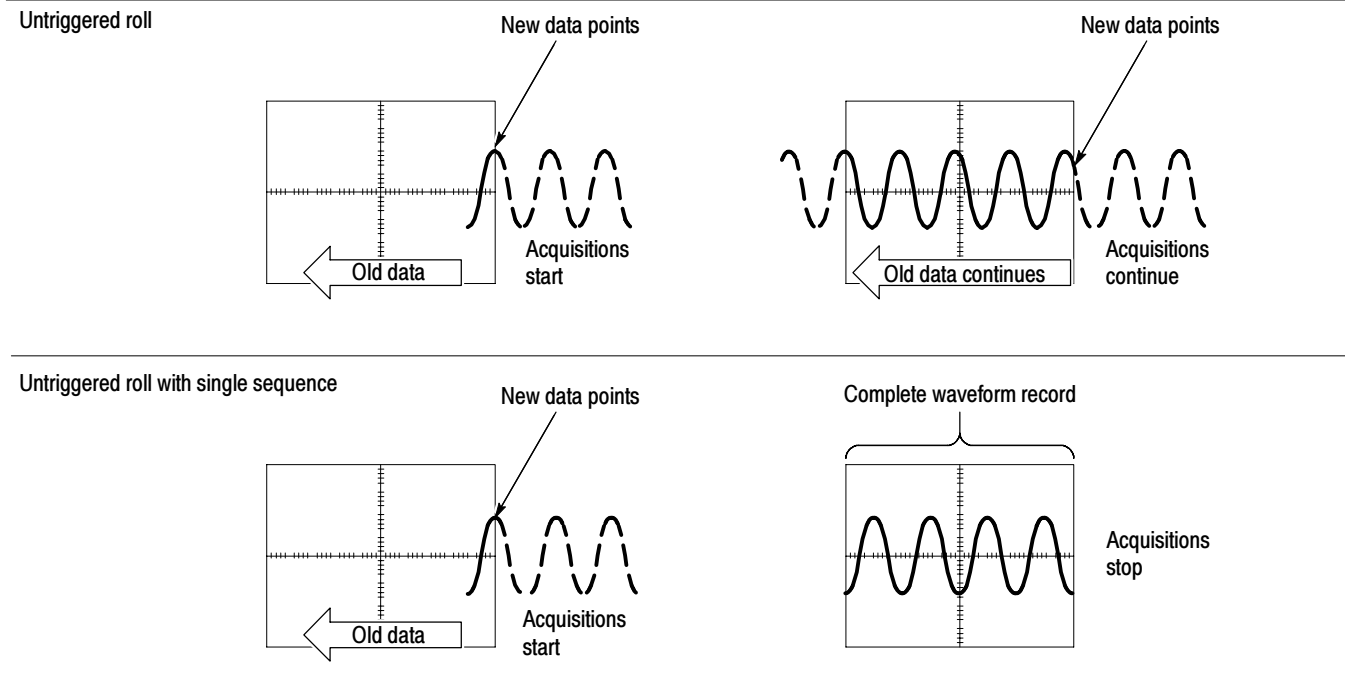

Figure 3-6: Roll mode

Global Controls. Like the horizontal controls, the acquisition controls apply to all active channels; for example, channel 1 cannot acquire in Sample mode while channel 2 acquires in Envelope mode. You cannot stop channel 4 from acquiring (if turned on) while other channels continue to acquire.

Preventing Aliasing. Under certain conditions, a waveform may be aliased on screen. Read the following description about aliasing and the suggestions for preventing it.

When a waveform aliases, it appears on screen with a frequency lower than the actual waveform being input or it appears unstable even though the **TRIG'D** light is lit. Aliasing occurs because the oscilloscope is not sampling the signal fast enough to construct an accurate waveform record. (See Figure 3-7.)

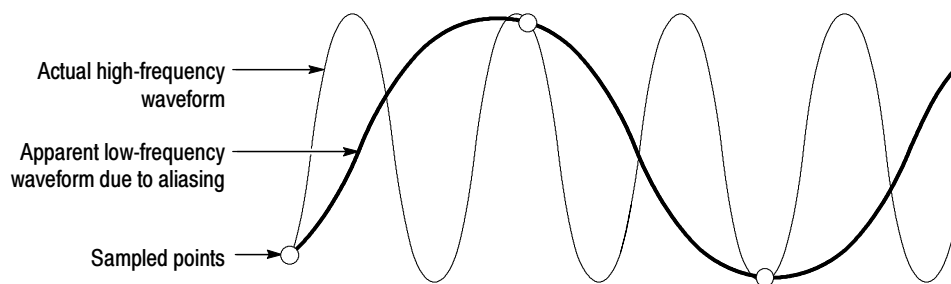

Figure 3-7: Aliasing

Methods to Check and Eliminate Aliasing. To quickly check for aliasing, slowly increase the horizontal scale (time per division setting). If the shape of the displayed waveform changes drastically or becomes stable at a faster time base setting, your waveform was probably aliased.



To avoid aliasing, be sure to sample the input signal at a rate more than twice as fast as the highest frequency component. For example, a signal with frequency components of 500 MHz would need to be sampled at a rate faster than 1 Giga-samples/second to represent it accurately and to avoid aliasing. The following tips may help you eliminate aliasing on a signal:

- Turn on Fast Acquisition mode to maximize the waveform capture rate.
- Turn on Waveform Database mode to capture more data.
- Try adjusting the horizontal scale.
- Try pushing the **AUTOSET** button.
- Try switching the acquisition to Envelope mode. Envelope searches for samples with the highest and lowest values over multiple acquisitions and can detect faster signal components over time.
- Turn on PeakDetect acquisition mode. If the waveform becomes an envelope, aliasing was occurring.

To Set Acquisition Modes

Use the procedure that follows to set the data acquisition mode and specify acquisition start/stop methods. For more information, display online help when performing the procedure.

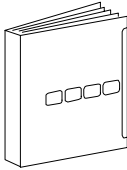
Overview	To set acquisition modes	Control elements & resources
----------	--------------------------	------------------------------

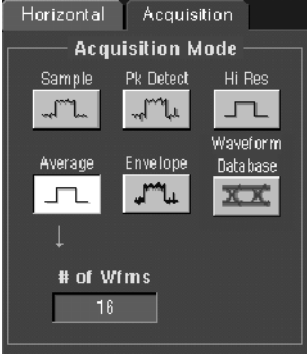
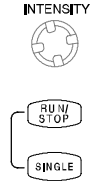
Overview	To set acquisition modes	Control elements & resources
<p>Prerequisites</p>	<p>1. Oscilloscope must be powered up, with horizontal and vertical controls setup. Triggering should also be set up.</p>	 <p>See page 3-53 for trigger setup.</p>
<p>To select an acquisition mode</p>	<p>2. Touch the Horiz button. Select the Acquisition tab from the Horiz/Acq setup window.</p>	
<p>Select the acquisition mode</p> <p>Set waveform count (average and envelope only)</p>	<p>3. Touch an Acquisition Mode button to set the acquisition mode; choose from the following modes:</p> <ul style="list-style-type: none"> ■ Sample ■ Peak Detect ■ Hi Res ■ Envelope ■ Average ■ Waveform Database <p>For Average and Envelope modes only, select the number of acquisitions to average or envelope. For Waveform Database mode, select the number of samples desired.</p>	
<p>Set the stop mode</p>	<p>4. Push the RUN/STOP button (or touch Run/Stop in the Run/Stop control window) to toggle between starting (Running) and stopping acquisitions.</p> <p>5. Push the SINGLE button (or touch Single Sequence in the Run/Stop control window) to acquire enough waveforms to satisfy the acquisition mode and then stop.</p>	

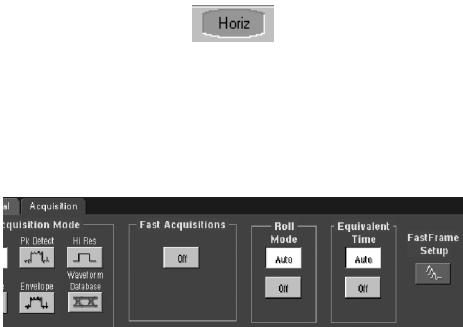

Overview	To set acquisition modes	Control elements & resources
<p>To select real-time or equivalent-time sampling</p>	<p>To limit the oscilloscope to real-time sampling or let it choose between real-time or equivalent-time sampling:</p> <ol style="list-style-type: none"> 6. Touch the Horiz button. Select the Acquisition tab from the Horiz/Acq control window, <p>Or select Horizontal/Acquisition Setup from the Horiz/Acq menu to display the Acquisition Mode control window. Select the Acquisition tab.</p> <ol style="list-style-type: none"> 7. Select Equivalent Time Auto or OFF: <ul style="list-style-type: none"> ■ Auto (Enable Equivalent Time) uses both the real-time and the equivalent-time sampling as appropriate (see Table 3-2 on page 3-36). ■ OFF (Real Time Only) limits the oscilloscope to real-time sampling. If the oscilloscope cannot accurately get enough samples for a complete waveform, it will interpolate. <p><i>Note: The oscilloscope will use the interpolation method selected in the display menu to fill in the missing record points — either linear or sin(x)/x interpolation. See Interpolation on page 3-37 for a discussion of interpolation.</i></p>	

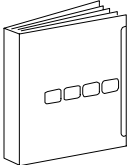
To Start & Stop Acquisition Use the procedure that follows to start and stop acquisition.

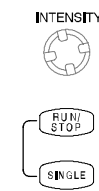
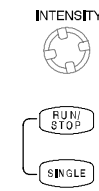
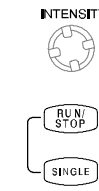
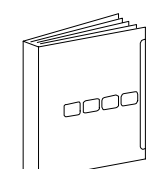
Overview	To start and stop acquisition	Control elements & resources
<p>Prerequisites</p>	<ol style="list-style-type: none"> 1. The horizontal and vertical controls must be set up. Triggering should also be set up. 	 <p>See page 3-27 for acquisition setup & page 3-53 for trigger setup.</p>

Overview	To start and stop acquisition	Control elements & resources
<p>To start acquiring</p>	<p>2. Make sure all the channels to be acquired are turned on (use channel buttons; see page 3-8 if needed). Then push the RUN button to begin acquiring.</p>	<p>INTENSITY</p> 
<p>To stop acquiring</p>	<p>3. Push the RUN/STOP button to stop acquisition. Acquisition will also stop if triggering ceases while in Normal trigger mode.</p>	<p>INTENSITY</p> 
<p>To take a single acquisition</p>	<p>4. Push the SINGLE button to start acquiring and acquire enough waveforms to satisfy the acquisition mode and then stop.</p>	<p>INTENSITY</p> 
<p>For more help</p>	<p>5. See references listed at right.</p>	 <p>See <i>To Set Up Acquisition Modes</i> on page 3-27 and <i>To Get More Help</i> on page 3-13.</p>

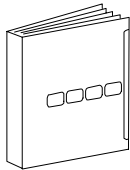
To Set Roll Mode Use the procedure that follows to set up roll mode acquisitions.

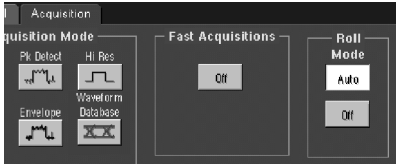
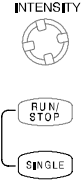
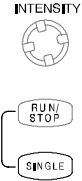
Overview	To set Roll Mode	Control elements & resources
<p>Prerequisites</p>	<p>1. The horizontal and vertical controls must be set up. Triggering should also be set up.</p>	 <p>See page 3-27 for acquisition setup & page 3-53 for trigger setup.</p>
<p>To enable roll mode</p>	<p>2. Touch the Horiz button. Select the Acquisition tab from the Horiz/Acq control window, or select Horizontal/Acquisition Setup from the Horiz/Acq menu to display the Acquisition Mode control window. Select the Acquisition tab.</p> <p>3. Select Roll Mode AUTO to enable roll mode.</p> <p>When the horizontal scale is 100 ms per division at a record length of 500 points and the acquisition mode is Sample or Pk Detect, roll mode turns on. As the record length becomes larger, the time per division required to enter roll mode becomes slower.</p> <p>Note: <i>Envelope, Average, FastAcq and Waveform Database acquisition modes inhibit roll mode.</i></p>	 
<p>To single sequence roll mode</p>	<p>4. Push the SINGLE button to start acquiring and acquire enough waveforms to satisfy the acquisition mode and then stop.</p>	
<p>To turn off roll mode acquisitions</p>	<p>5. Do the following step to stop acquisitions in roll mode:</p> <ul style="list-style-type: none"> ■ If you are not in Single Sequence, push RUN/STOP to stop roll mode. ■ If you are in Single Sequence, roll mode acquisitions stop automatically when a complete record is acquired. 	

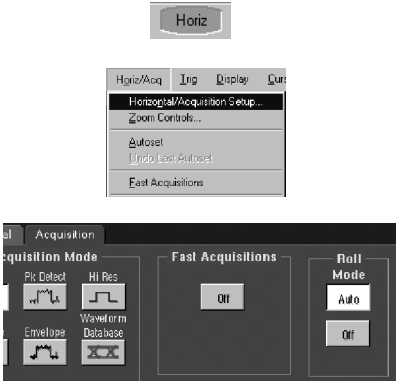
Overview	To set Roll Mode	Control elements & resources
<p>To disable roll mode</p>	<p>6. Touch the Horiz button. Select Acquisition tab from the Horiz/Acq control window, or select Horizontal/Acquisition Setup from the Horiz/Acq menu to display the Acquisition Mode control window. Select the Acquisition tab.</p> <p>7. Select Roll Mode OFF to disable roll mode.</p> <p>Or, whenever you set the Horizontal SCALE to 40 ms per division or faster, roll mode turns off. At record lengths greater than 500 points, the time per division required to turn off roll mode becomes slower.</p> <p>Note: <i>Envelope, Average, Fast Acquisition, and Waveform Database acquisition modes inhibit roll mode.</i></p>	

Acquisition Control Background

This section contains background information on the data sampling and acquisition process that can help you more effectively setup the acquisition window of each channel. This section:

- Describes the acquisition hardware.
- Defines the sampling process, sampling modes, and the waveform record.
- Describes both the normal and Fast Acquisitions acquisition cycles.

Acquisition Hardware

Before a signal can be acquired, it must pass through the input channel where it is scaled and digitized. Each channel has a dedicated input amplifier and digitizer as shown in Figure 3-8; each channel can produce a stream of digital data from which waveform records can be extracted. See *Signal Connection and Conditioning* on page 3-4 for further description of scaling, positioning, and DC offsetting of channels.

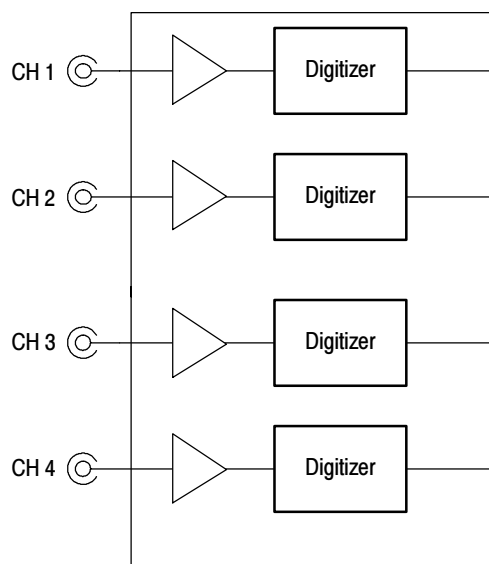

Figure 3-8: Digitizer configuration

Sampling Process

Acquisition is the process of sampling the analog input signal of an input channel, converting it into digital data, and assembling it into a waveform record, which is then stored in acquisition memory. Sampling, then, is the process that provides a waveform record per trigger event (see Figure 3-10 on page 3-34). The signal parts within the vertical range of the amplifier are digitized. See Figure 3-9.

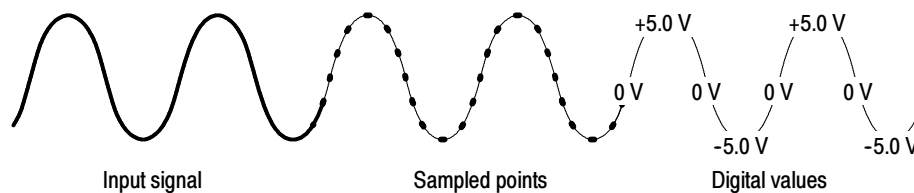

Figure 3-9: Digital acquisition — sampling and digitizing

Sampling Modes

The oscilloscope acquisition system can process the data as it is acquired, averaging or enveloping the waveform data to produce enhanced waveform records. Once the waveform record exists (enhanced or not), you can use the post-processing capabilities of the oscilloscope to further process that record: perform measurements, waveform math, and so on. Refer to *Keys to Using* on page 3-22 for a description of the acquisition modes.

Waveform Record

While sampling on the input signal provides the data that makes up the waveform record for any given channel, the oscilloscope builds the waveform record through use of some common parameters (“common” means they affect the waveforms in all channels).

Figure 3-10 shows how these common parameters define the waveform record; as shown in the figure, they define where in the data stream and how much data is taken. Locate the following parameters in the figure:

- **Sample Interval.** The time between sample points taken during acquisition.
- **Record Length.** The number of samples required to fill a waveform record.
- **Trigger Point.** The trigger point marks the time zero in a waveform record. All waveform samples are located in time with respect to the trigger point.
- **Horizontal Position.** If horizontal delay is off, the time lapse from the first sample taken (first point in the waveform record) to the trigger point (in percent of samples before the trigger). When horizontal delay is off, the trigger point and the horizontal reference are at the same point in the waveform record.

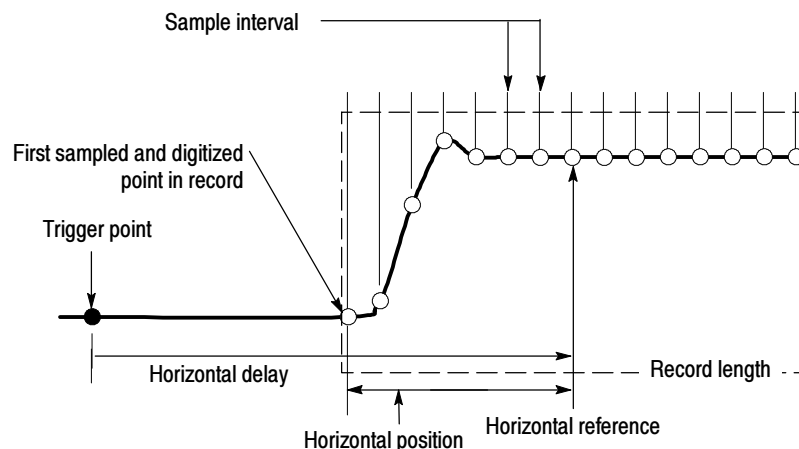

Figure 3- 10: The waveform record and its defining parameters

As Figure 3-10 shows, the oscilloscope acquires points in order from left to right.

When all the points in the waveform record have been sampled and digitized, the waveform record is in acquisition memory and becomes available for display (or use in math waveforms, storage, and so on). See *Acquisition Cycle*, which follows.

For a control-oriented discussion of the waveform record, see *Horizontal Acquisition Window Considerations* on page 3-18 and *Horizontal Scale vs. Record Length vs. Sample Interval vs. Resolution* on page 3-19.

Real-time Sampling

The two general methods of sampling are *real-time* and *equivalent-time*. This oscilloscope uses both real- and equivalent-time sampling.

In real-time sampling, the oscilloscope digitizes all the points it acquires after *one* trigger event (see Figure 3-11). Always use real-time sampling to capture single-shot or transient events.

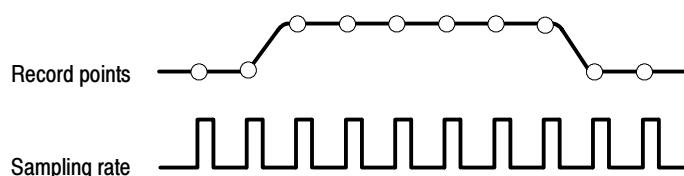

Figure 3-11: Real-time sampling

Equivalent-time Sampling

The oscilloscope uses equivalent time sampling to extend its sample rate beyond its real-time maximum sampling rate, but only under two conditions:

- You must have turned equivalent-time on in the Acquisition Setup control window.
- You must have set the oscilloscope to a sampling rate that is too fast to allow it to get enough samples with which to create a waveform record using real-time sampling.

If both conditions are the case, the oscilloscope takes a few samples with each trigger event and eventually obtains enough samples to construct a waveform record. In short, the oscilloscope makes *multiple* acquisitions of a *repetitive* waveform to obtain the sample density required for a waveform record. (See Figure 3-12.) Equivalent-time sampling should only be used on repetitive signals.

The sampling speeds and the number of channels you choose affect the mode the oscilloscope uses to sample waveforms:

- The oscilloscope always real-time samples at slower time base settings; faster time settings force the oscilloscope to switch from real-time sampling to equivalent-time sampling or interpolation, depending on whether Equivalent Time is on or off.
- The oscilloscope extends the limit at which it must switch from real-time sampling by using the digitizers of channels that are turned off to sample the channel or channels that are turned on.

Check Table 3-2 below to determine the time base setting(s) at which the switch from real-time sampling (RT) to equivalent time sampling or interpolation (ETI) occurs for your oscilloscope.

Table 3-2: Sampling mode selection

Model	TDS7054			TDS7104		
	1	2	3 or 4	1	2	3 or 4
Time base¹						
> 20 ns	RT ²	RT	RT	RT	RT	RT
10 ns	RT	RT	ETI	RT	RT	ETI
5 ns	ETI	ETI	ETI	RT	ETI	ETI
< 2 ns	ETI ³	ETI	ETI	ETI ³	ETI	ETI

- 1 “>” means “slower than”; “<” means “faster than.”
- 2 “RT” abbreviates “Real-Time Sampling” throughout this table.
- 3 “ETI” abbreviates “Equivalent-Time Sampling” throughout this table.

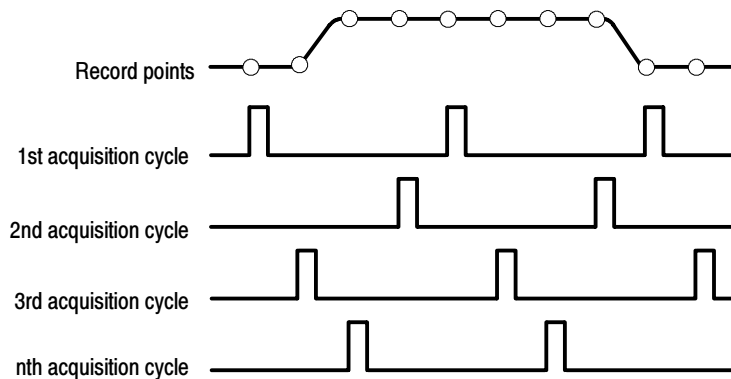

Figure 3- 12: Equivalent-time sampling

The type of equivalent-time sampling the oscilloscope uses is called *random equivalent-time sampling*. Although it takes the samples sequentially in time, it takes them randomly with respect to the trigger. Random sampling occurs because the oscilloscope sample clock runs asynchronously with respect to the input signal and the signal trigger. The oscilloscope takes samples independently of the trigger position and displays them based on the time difference between the sample and the trigger.

Interpolation

Your oscilloscope can interpolate between the samples it acquires. Like for equivalent time sampling, it does so only when it does not have all the *real* samples it needs to fill its displayed waveform. For instance, setting ZOOM to progressively larger amounts of expansion. The oscilloscope then interpolates to create the intervening points in the displayed waveform. If the time per division is set fast enough to require equivalent time but equivalent time is disabled, the instrument interpolates points. There are two options for interpolation: linear or $\sin(x)/x$. (The oscilloscope can also equivalent-time sample to acquire more samples; see *Equivalent-Time Sampling* on page 3-35.)

Linear interpolation computes record points between actual acquired samples by using a straight line fit. It assumes all the interpolated points fall in their appropriate point in time on that straight line. Linear interpolation is useful for many waveforms such as pulse trains.

Sin(x)/x interpolation computes record points using a curve fit between the actual values acquired. It assumes all the interpolated points fall along that curve. $\sin(x)/x$ is particularly useful when acquiring more rounded waveforms such as sine waves. Actually, it is appropriate for general use, although it may introduce some overshoot or undershoot in signals with fast rise times, especially if you use zoom and the waveform edges are undersampled.

NOTE. *When using either type of interpolation, you may want to set the display style so that the real samples are displayed intensified and interpolated samples are dimmed. The instructions under Select the Display Style on page 3-118 explain how to turn on intensified samples.*

Interleaving

The oscilloscope can interleave its channels to attain higher digitizing rates without equivalent time sampling. The oscilloscope applies the digitizing resources of unused channels (that is, channels that are turned off) to sample those that are in use (turned on). Table 3-3 lists how interleaving more than one digitizer to sample a channel extends the maximum digitizing rate.

Once you set horizontal scale to exceed the maximum digitizing rate for the number of channels in use (see Table 3-3), the oscilloscope will not be able to get enough samples to create a waveform record. At that point, the oscilloscope will switch from real to equivalent time sampling to obtain additional samples. (See *Equivalent-time Sampling* on page 3-35.)

Table 3-3: How interleaving affects sample rate

Number of channels in use	Maximum digitizing rate when real-time sampling	
	TDS7054	TDS7104
One	5 GS/sec	10 GS/sec
Two	5 GS/sec	5 GS/sec
Three or Four	2.5 GS/sec	2.5 GS/sec

Using Fast Acquisition Mode

This section describes how to use Fast Acquisition mode and how it differs from normal acquisition mode.

Fast acquisition mode reduces the dead time between waveform acquisitions that normally occur when digitizing storage oscilloscopes (DSOs) acquire waveforms. This dead-time reduction enables Fast Acquisition mode to capture and display transient events, such as glitches or runt pulses, often missed during longer dead times that accompany normal DSO operation. Fast Acquisition mode can also display waveform phenomena at an intensity that reflects their rate-of-occurrence.

Fast XY and XYZ modes also provide intensity information by accepting continuous, non-triggered data from the input channels.

Measurements and histograms are done directly on the two dimensional array of display pixels. In infinite persistence mode, the array accumulates more information and measurements are more accurate.

Several modes/features are incompatible with Fast Acquisitions mode and if you select them they will inhibit Fast Acquisitions:

- FastFrame and Zoom modes
- Envelope, Average, waveform database, Hi Res, and Single Acquisition Sequence acquisition modes
- Intensified time base
- Interpolation (equivalent time sampling is used instead)
- Vectors when in equivalent time mode (waveforms are displayed as Dots instead). (To determine under what conditions the oscilloscope normally interpolates or uses equivalent time, see *Equivalent-time Sampling* on page 3-35.)
- Math waveforms
- Measurements on channels when in Fast XY or XYZ

If you select any of these modes before or while Fast Acquisitions is on, they will inhibit, temporarily turn off, Fast Acquisitions mode.

Using Fast Acquisitions

Consider the mode you want to use to acquire data:

Automatic Selection. Fast Acquisitions automatically selects record length and sample rate to optimize the displayed image by optimizing live time and minimizing dead time. Fast Acquisitions selects sample rates up to 1.25 GS/s and record lengths up to 1000000 and compresses them to 500 pixels to produce the maximum display content.

Waveform Capture Rate. Figures 3-13 and 3-14 illustrate how Fast Acquisitions mode differs from the normal acquisition mode used by digital storage oscilloscopes. Note that normal mode follows a “capture waveform-digitize waveform-update waveform memory-display waveform” cycle. Normal mode misses short term events occurring during the long dead times. Typical waveform capture rates are 50 waveforms per second.

Fast Acquisitions mode increases the waveform capture rate to up to 200,000 waveforms per second, updating the waveform array many times between displays. This very fast capture rate greatly increases the probability that runts, glitches, and other infrequent events will accumulate in waveform memory. The oscilloscope then displays the waveform at the normal display rate. You can control the waveform intensity using adjustable or automatic brightness (see page 3-44 for more information).

Fast Acquisitions mode adds intensity or gray scale information, like an analog oscilloscope, to each point in the waveform array. The waveform array is a two dimensional array of display pixels. Display pixel values are incremented each time they are written by a waveform acquisition.

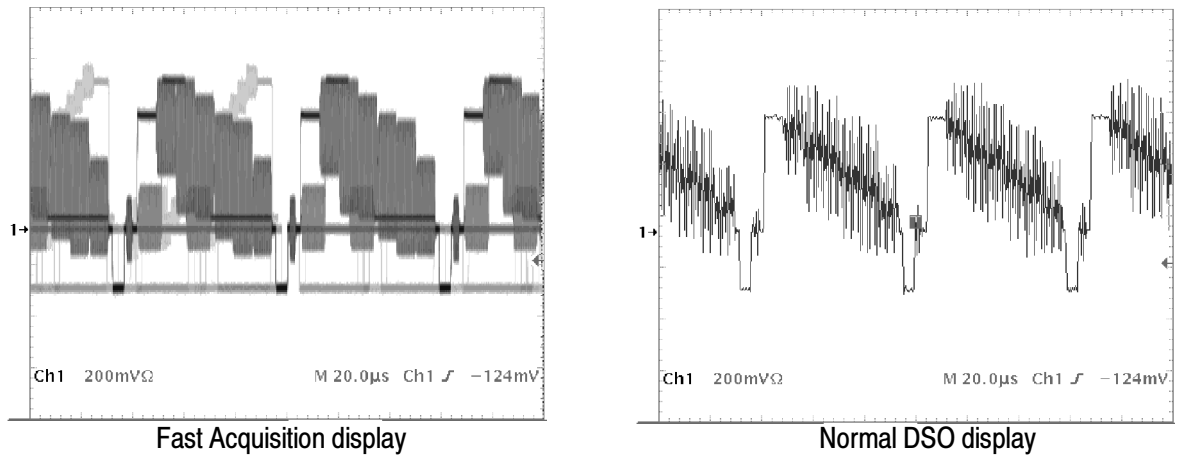
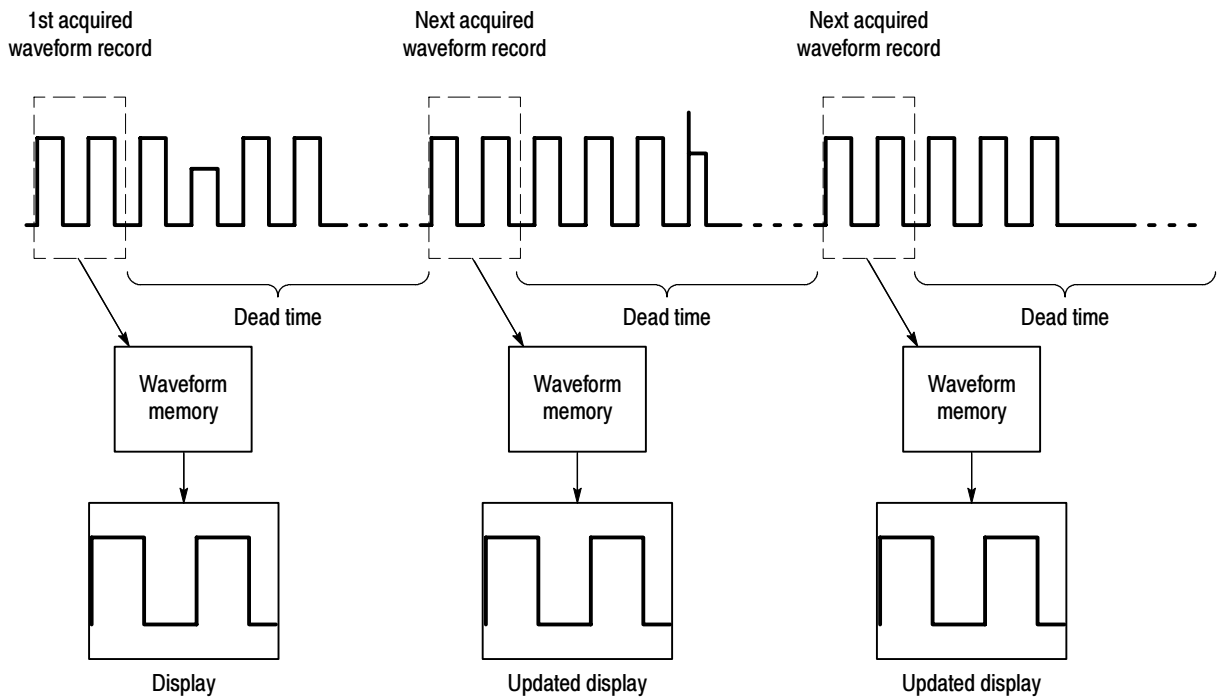

Figure 3- 13: Normal DSO and Fast Acquisition displays

Normal DSO Mode



Fast Acquisition Mode

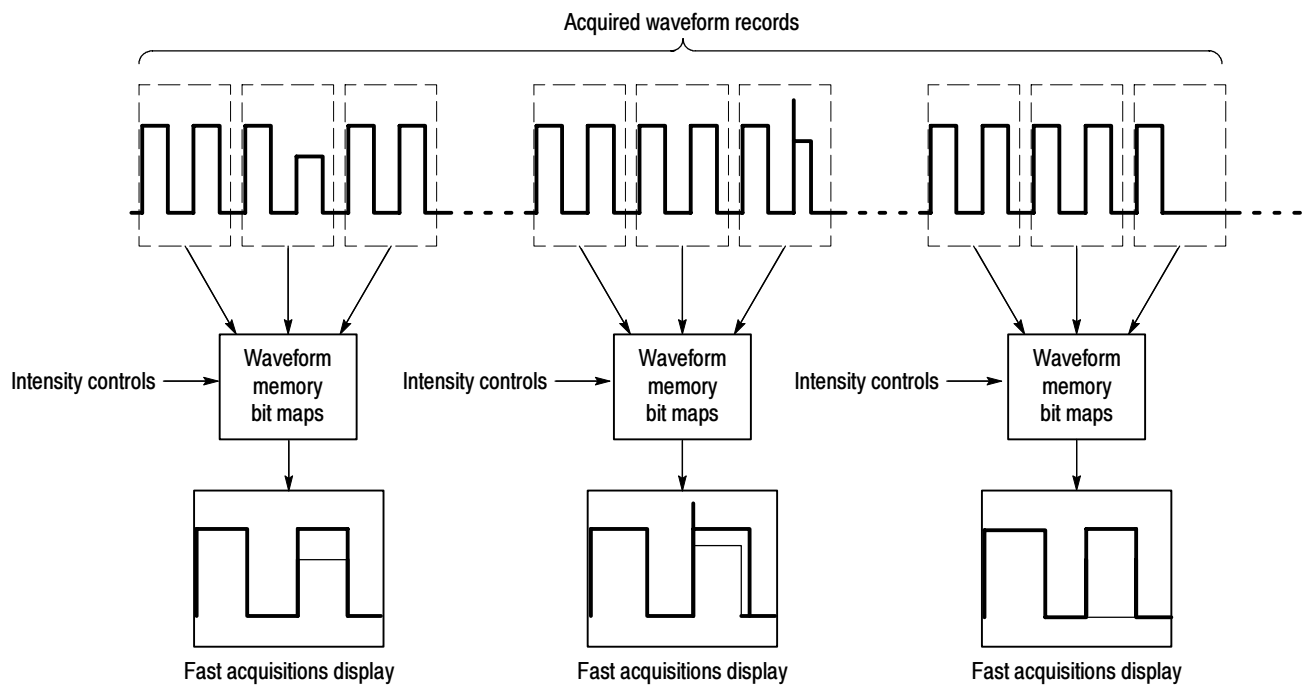
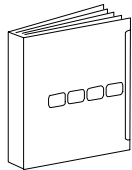
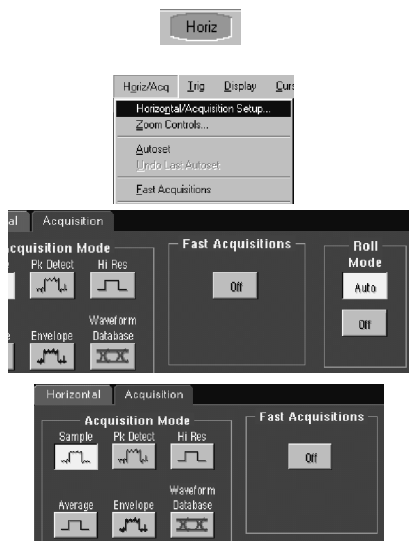

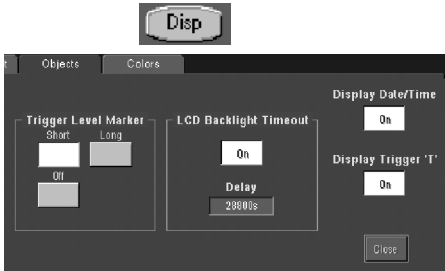
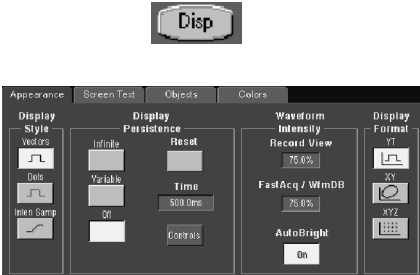
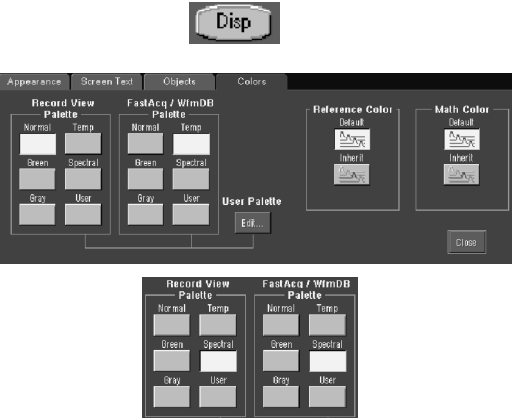

Figure 3-14: Normal DSO Acquisition and Display mode versus Fast Acquisition mode

To Turn Fast Acquisitions On and Off Use the procedure that follows to set up Fast Acquisitions mode.

Overview	To turn Fast Acquisitions on and off	Control elements & resources
<p>Prerequisites</p>	<p>1. The horizontal and vertical controls must be set up. Triggering should also be set up.</p>	 <p>See page 3-27 for acquisition setup.</p>
<p>To enable fast acquisitions mode</p>	<p>2. Touch the Horiz button. Select the Acquisition tab from the Horiz/Acq control window, Or select Horizontal/Acquisition Setup from the Horiz/Acq menu to display the Acquisition Mode control window. Select the Acquisition tab.</p> <p>3. Touch Fast Acquisitions to toggle Fast Acquisitions to ON. Or push the front-panel FastAcq button.</p> <p>Fast Acquisitions mode will stay on until you turn it off or until you select an incompatible mode that temporarily inhibits fast acquisitions.</p>	

Overview	To turn Fast Acquisitions on and off	Control elements & resources
<p>To set the style</p>	<ol style="list-style-type: none"> 4. Touch the DISP button, and select the Appearance tab. 5. Select between Vectors, Dots, or Intens display styles. (Dots is the default setting when in Equivalent Time (ET) acquisition mode. Vectors is the default when not in ET acquisition mode.) 6. Select between Off and Variable Display Persistence. (Off is the factory default setting.) <p>Variable persistence is explained on page 3-116. No Persistence erases the display each time a new waveform array is displayed.</p> <p>Mask Autofit can affect persistence. When enabled Autofit moves the waveform vertically and horizontally to reduce the number of hits within a given mask. If infinite or variable persistence is enabled, the movements will clear any persisted data. If Autofit makes frequent adjustments, there can be very little or even no persisted data displayed.</p> 7. If you select Variable, touch Persist Time and adjust the persistence time (decay rate). 	
<p>To set the display readout options</p>	<ol style="list-style-type: none"> 8. Touch the DISP button, and select the Objects tab. 9. Touch Display Date/Time to toggle between On and Off. (On displays the date and time.) 10. Touch Display Trigger T to toggle between On and Off. (On displays the trigger T at the trigger location.) 	

Overview	To turn Fast Acquisitions on and off	Control elements & resources
<p>To adjust the intensity</p>	<p>11. Touch the DISP button, and select the Appearance tab.</p> <p>12. Touch Waveform AutoBright to toggle between On and Off.</p> <ul style="list-style-type: none"> ■ On automatically sets the intensity maximum to the value of the most frequent event. ■ Off lets the displayed brightness depend on the trigger rate, creating a display like an analog oscilloscope. <p>13. Rotate the INTENSITY knob to adjust the intensity of displayed waveforms.</p> <p>Or touch Intensity and enter the intensity value with the keypad or the general purpose knob.</p> <p>14. To change the intensity setting for fast acquisition and waveform database waveforms, touch FastAcq/WfmDB and enter the intensity value with the keypad or the multipurpose knob.</p>	 <p>The screenshot shows the 'Disp' button at the top. Below it is the 'Appearance' tab with sub-tabs for 'Screen Text', 'Objects', and 'Colors'. The 'Display Persistence' section has 'Infinite' selected. The 'Waveform Intensity' section shows 'Record View' at 75.0% and 'FastAcq / WfmDB' at 75.0%. The 'AutoBright' option is set to 'On'.</p>
<p>To select the color palette</p>	<p>15. Touch the DISP button, and select the Colors tab.</p> <p>Normal, Green, and Gray give the appearance of an intensity-graded display similar to an analog oscilloscope.</p> <p>Spectral and Temp use hue to indicate the frequency of occurrence and to highlight events.</p> <p>User and User Palette let you create a custom color palette.</p> <p>16. Choose the Spectral color palette.</p> <p>In Fast Acquisition mode, Temp and Spectral show more detail than the other color palettes.</p> <p>For a definition of each color palette, see <i>Color Palette</i> on page 3-115.</p>	 <p>The screenshot shows the 'Colors' tab with sub-tabs for 'Appearance', 'Screen Text', and 'Objects'. It features 'Record View Palette' and 'FastAcq / WfmDB Palette', each with 'Normal', 'Temp', 'Green', 'Spectral', and 'Gray' options. There is also a 'User Palette' with an 'Edit...' button, 'Reference Color' (Default), and 'Multi Color' (Default) sections.</p>

To Set Display Format The oscilloscope displays waveforms in one of three formats: YT, XY, or XYZ. Use the procedure that follows to set the display format.

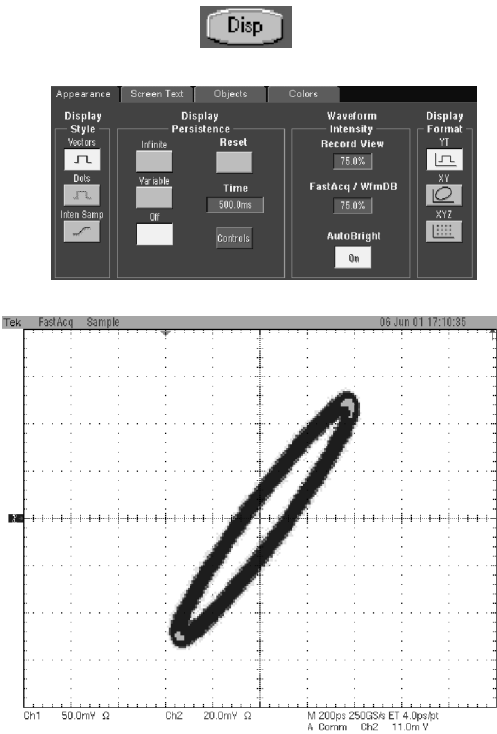
Overview	To set display format	Control elements & resources
<p>To select the format</p>	<ol style="list-style-type: none"> To set the display axis format, touch the DISP button, and select the Appearance tab. Select between YT, XY, and XYZ display formats: <p>YT. This format is the conventional oscilloscope display format. It shows a signal voltage (the vertical axis) as it varies over time (the horizontal axis).</p> <p>XY. This format compares the voltage levels of two waveform records point by point (see Figure 3-15). That is, the oscilloscope displays a graph of the data of one channel versus another. The data is a continuous stream, and there are no waveform records. XY requires Fast Acquisitions mode. This mode is particularly useful for studying phase relationships. XY format is not triggered. When you set the VERTICAL POSITION and Vertical Offset to center the display in YT mode, the XY display is at center screen, and each division of display in YT mode produces a division of display in XY mode.</p> <p>When you choose the XY format, any channel displayed is assigned to the axis indicated in Table 3-4 and displayed as part of an XY pair. If only one source in an XY pair is displayed, the oscilloscope automatically turns on the other source to complete the XY pair. Moreover, once XY is on, selecting either source in a pair turns the pair on; turning either waveform of a pair off removes both sources from the display.</p> <p>XY format is a dot-only display, although it can have persistence. The Vector style selection has no effect when you select XY format.</p> <p>If in XY or XYZ, histograms are allowed. The HORIZONTAL controls still control the timebase, sample rate, and so forth, but the changes are not reflected in the horizontal axis as in YT display format.</p> <p>XYZ. This format compares the voltage levels of the CH 1 (X) and CH 2 (Y) waveform records point by point as in XY format. XYZ requires Fast Acquisitions mode. The displayed waveform intensity is modulated by the CH 3 (Z) waveform record. XYZ format is not triggered. A -5 division signal (including position and offset) on CH 3 produces a blank screen; a +5 division signal produces full intensity.</p> 	 <p>Figure 3-15: Fast Acquisition XY display</p>

Overview	To set display format	Control elements & resources
For help	3. For more information on the controls described in this procedure, touch the Disp or Horiz button. Touch the HELP button in the tool bar.	

Table 3-4: XY format pairs

XY Pair	X-Axis source	Y-Axis source
Ch 1 and Ch 2	Ch 1	Ch 2
Ch 3 and Ch 4	Ch 3	Ch 4

Using FastFrame

FastFrame is an acquisition mode that lets you capture many records in a larger record, and then view and measure each record individually.

FastFrame lets you quickly capture multiple acquisitions in the acquisition memory of a single channel. Figure 3-16 shows how FastFrame combines the desired captured frames into one larger waveform. For example, FastFrame would let you store 4000 frames (depending on the record length option installed) of 500 samples each into one waveform.

FastFrame mode lets you jump to and view the desired frame. Time Stamps can display the absolute trigger time for a specific frame and the relative time between triggers of two specified frames. FastFrame lets you compare different waveforms. Math is done on each frame.

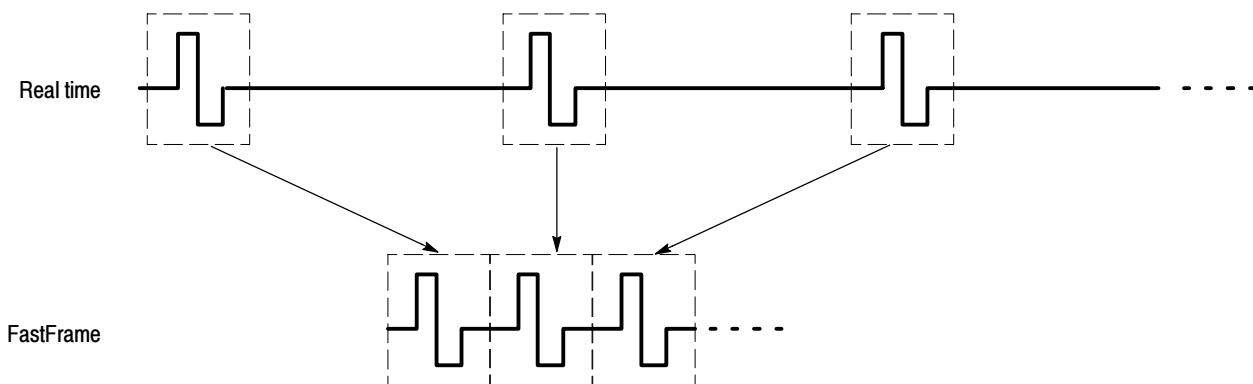

Figure 3-16: FastFrame

FastFrame is not compatible with other features or modes:

- Equivalent Time
- Histograms
- Fast Acquisitions
- Average
- Envelope
- Waveform Database

Using FastFrame Acquisitions

Consider the following operating characteristics when using FastFrame:

- You can push **RUN/STOP** to terminate a FastFrame sequence. If any frames were acquired, they are displayed. If no frames were acquired, the previous FastFrame waveform is displayed.
- Because FastFrame introduces additional processing time into the operation cycle of acquire, process, and display, its best to use Single Sequence Acquisition (see Acquire menu, Stop After menu). With Single Sequence selected, you will see the current acquisition sequence; otherwise, the display lags the current sequence by one sequence. You can also see the current sequence by pushing the RUN/STOP button to stop the acquisition.
- FastFrame reduces the time required before the trigger is rearmed, while preserving the individual subrecords, a detail lost in Fast Acquisitions which writes all acquired records to a single pixel map.

To Set FastFrame Mode Use the procedure that follows to set up FastFrame mode acquisitions.

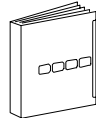
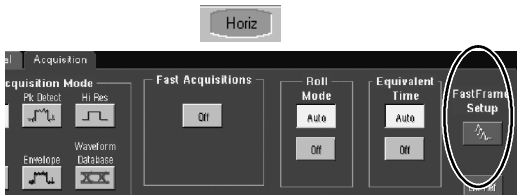
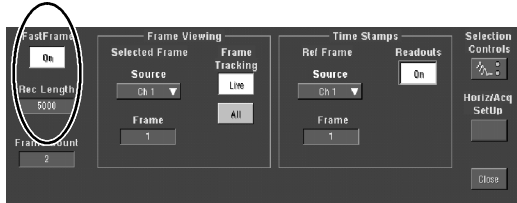
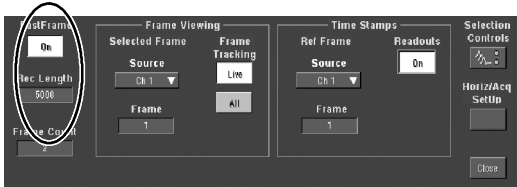
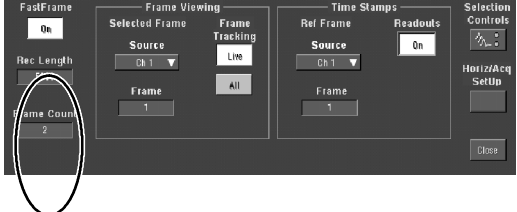
Overview	To set FastFrame mode	Control elements & resources
<p>Prerequisites</p>	<p>1. The horizontal and vertical controls must be set up. Triggering should also be set up.</p>	 <p>See page page 3-27 for acquisition setup & page 3-53 for trigger setup.</p>
<p>To set FastFrame mode</p>	<p>2. Touch the Horiz button. Select the Acquisition tab from the Horiz/Acq control window. Touch FastFrame Setup to display the FastFrame Setup control window.</p> <p>3. Touch FastFrame to toggle FastFrame to On.</p>	 
<p>Set frame length</p>	<p>4. Touch Rec Length, and set the number of samples per frame.</p> <p>Record length is the number of samples in each acquisition.</p>	
<p>Set frame count</p>	<p>5. Touch Frame Count, and enter the number of frames to acquire per waveform record.</p> <p>Frame count is the number of acquisitions to store in the acquisition memory of the channel. The oscilloscope will set the record length to a value greater than or equal to the product of the frame count and the frame length. If the product of the record length and the frame count exceeds the available memory, the oscilloscope will reduce the record length or frame count in size such that the product will fit the amount of memory available. Available memory is a combination of acquisition memory and system memory.</p>	

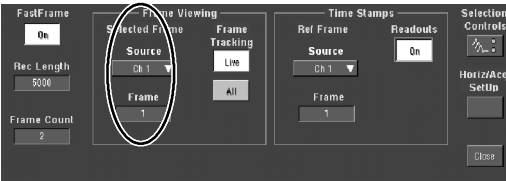
Overview	To set FastFrame mode	Control elements & resources
<p>Select the frame to view</p>	<ol style="list-style-type: none"> In the Frame Viewing controls, touch Source and select the source of the frame you want to view. In the Frame Viewing control, touch Frame and use the general purpose knob or keypad to enter the number of the specific frame you want to view. The frame that you select appears on the display. 	

Time Stamping Frames Use Time Stamps to display the absolute trigger time for a specific frame and the relative time between triggers of two specified frames. To start FastFrame Time Stamps, do the following steps:

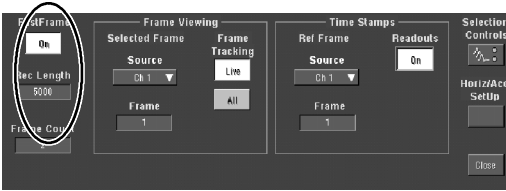
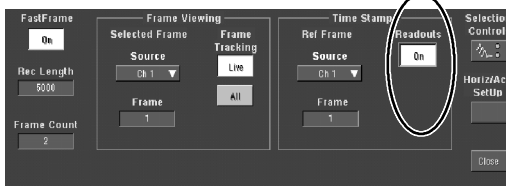
Overview	Time stamping frames	Control elements & resources
<p>Prerequisites</p>	<ol style="list-style-type: none"> FastFrame mode should be set up as described in the previous example. Turn on FastFrame as described starting on page 3-48. 	
<p>Turn readouts on or off</p>	<ol style="list-style-type: none"> In the Time Stamps controls, touch Readouts to toggle time stamp readouts on or off: <ul style="list-style-type: none"> On displays time stamp readouts (see Figure 3-17) Off turns off the display of time stamp readouts <p>The displayed time uses the following format:</p> <pre>Sel Ch# F xxx DD MMM YYYY HH:MM:SS.mmm μμμ nnn ppp Ref Ch# F xxx DD MMM YYYY HH:MM:SS.mmm μμμ nnn ppp Δ DD MMM YYYY HH:MM:SS.mmm μμμ nnn ppp</pre> <p>Where:</p> <p>Sel and Ref Ch# F xxx are the selected or reference frame number DD MMM YYYY is the date (day, month, and year) HH:MM:SS.mmm, is the clock time (hours, minutes, seconds, and milliseconds) μμμ,nnn,ppp is a fraction of a second (to picoseconds)</p> 	

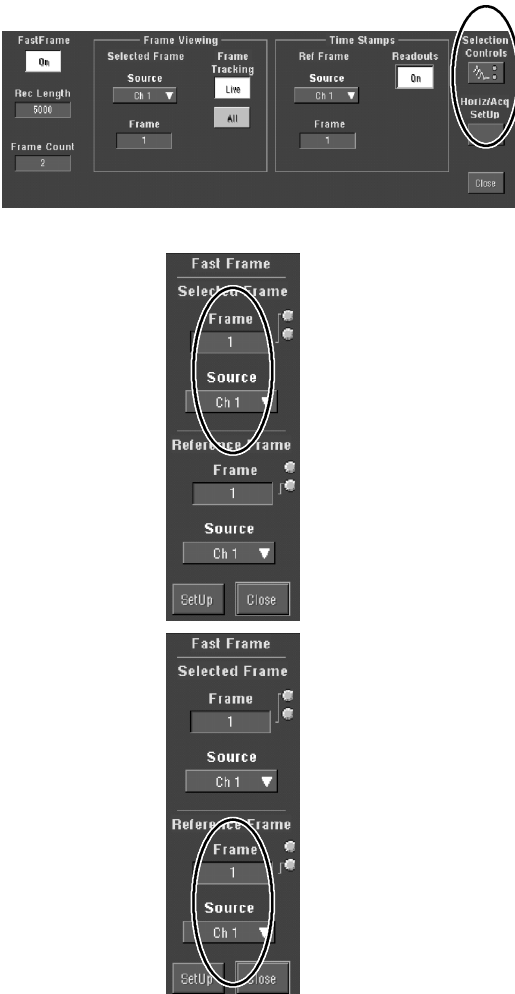
Overview	Time stamping frames	Control elements & resources
<p>Select the reference frame</p>	<ol style="list-style-type: none"> In the Time Stamps controls, touch Source and select the source of the reference frame. In the Time Stamps controls, touch Frame and use the general purpose knob or keypad to enter the number of the reference frame. This value sets the starting frame when measuring the relative time between two frames. 	
<p>Select the FastFrame and time stamps selection controls</p>	<p>You may set the Selected Frame and Reference Frame as previously shown or you can set them from the Selection Controls window.</p> <ol style="list-style-type: none"> Touch Selection Controls from the Time Stamps control window to display the FastFrame controls. In the FastFrame controls window, touch Selected Frame Source and select the source of the frame you want to view. Touch Selected Frame Frame and use the general purpose knob or keypad to enter the number of the specific frame you want to view and take time stamps on. The frame you select appears on the display. <p>Note: The Δ is the selected time stamp - the reference time stamp.</p> <ol style="list-style-type: none"> Touch the Reference Frame Source and select the source of the reference frame. Touch Frame and use the general purpose knob or keypad to enter the number of the reference frame. 	

Overview	Time stamping frames	Control elements & resources
<p>To lock the reference position frames</p>	<p>10. Touch the Horiz button. Select the Acquisition tab from the Horiz/Acq control window. Touch FastFrame Setup to display the FastFrame Setup control window.</p> <p>Note: You can also get the FastFrame Setup control window by pushing the Set Up button on the Selection Controls window.</p> <p>11. Touch either Frame Tracking Live or All to lock the reference and position frames together. When the frames are locked, they maintain the same relative distance from each other when either frame is adjusted:</p> <ul style="list-style-type: none"> ■ Live locks together the channel and math waveforms. All reference waveforms are locked together, but they are separate from the channel and math waveforms. ■ All locks together all channel, math, and reference waveforms; adjusting one waveform adjusts all waveforms. 	

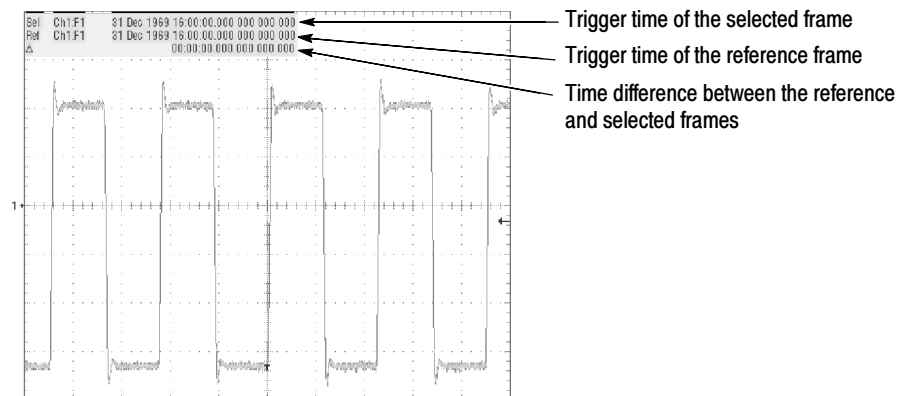
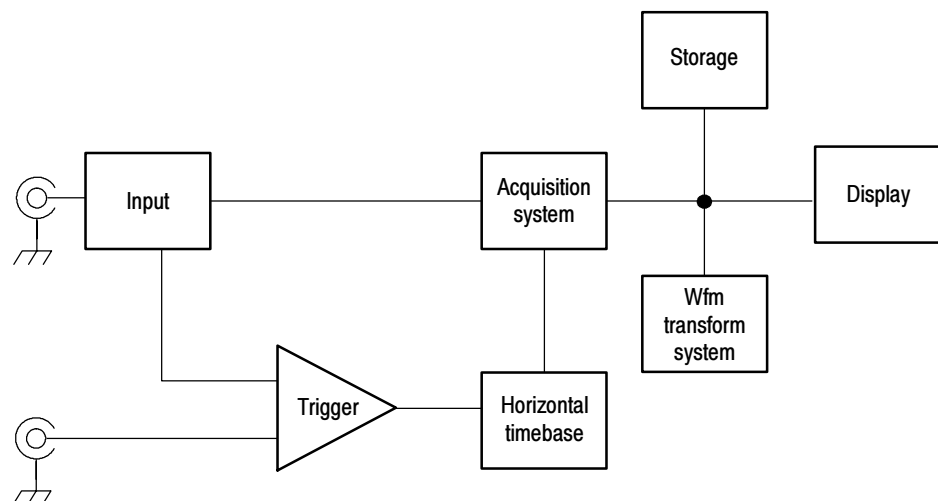

Figure 3-17: FastFrame time stamp

Triggering

To properly acquire data, that is, to use the oscilloscope to sample a signal and digitize it into a waveform record that you want to measure or otherwise process, you need to set up the trigger conditions. This section provides background on, and the procedures for using, the basic elements of triggering: source, holdoff, mode, and so on. This section covers the following topics:

- *Trigger Concepts* which describes some basic principles of triggering and the following trigger elements: *type, source, coupling, holdoff, mode*, and so on
- *Triggering from the Front Panel* which describes how to use the front-panel triggering controls each of which is common to most of the trigger types the oscilloscope provides
- *Additional Trigger Parameters* which describes how to access common trigger functions in the Trigger control window
- *Advanced Triggering* which describes trigger types that you can use to isolate specific signal phenomena
- *Sequential Triggering* which describes how to combine the A (Main) and B (Delayed) trigger systems to capture unique events
- *Comm Triggering* (Option SM only) which describes triggering on communications signals



Triggering Concepts

Triggers determine when the oscilloscope stops acquiring and displays a waveform. They help create meaningful waveforms from unstable jumbles or blank screens. (See Figure 3-18.) The oscilloscope has simple edge triggers as well as a variety of advanced triggers you can use.

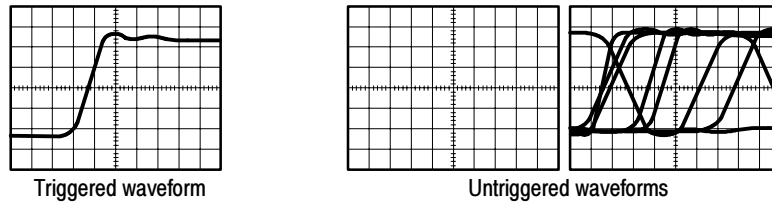

Figure 3-18: Triggered versus untriggered displays

The Trigger Event

The trigger event establishes the time-zero point in the waveform record. All points in the record are located in time with respect to that point. The oscilloscope continuously acquires and retains enough sample points to fill the pretrigger portion of the waveform record (that part of the waveform that is displayed *before*, or to the left of, the triggering event on screen). When a trigger event occurs, the oscilloscope starts acquiring samples to build the posttrigger portion of the waveform record (displayed *after*, or to the right of, the trigger event). Once a trigger is recognized, the oscilloscope will not accept another trigger until the acquisition is complete and the holdoff time has expired.

Trigger Sources

The trigger source provides the signal that triggers acquisition. Use a trigger source that is synchronized with the signal you are acquiring and displaying. You can derive your trigger from the following sources:

Input channels are the most commonly used trigger sources. You can select any one of the four input channels. The channel you select as a trigger source will function whether it is displayed or not.

AC Line Voltage is a convenient trigger source when you are looking at signals related to the power line frequency. Examples include devices such as lighting equipment and power supplies. Because the oscilloscope generates the trigger from the power line, you do not have to use a channel input.

Auxiliary Trigger (AUX IN) provides a fifth source you can use as a trigger input when you need to use the four input channels for other signals. For example, you might want to trigger on a clock while displaying four other logic signals. To use the auxiliary trigger, connect the signal to the Auxiliary Trigger input connector on the front panel. The Auxiliary Trigger input is not compatible with most probes, nor can you display the auxiliary trigger signal.

Trigger Types

The oscilloscope provides two categories of trigger types:

Edge is the simplest and most commonly used trigger type. You can use it with analog or digital signals. An edge trigger event occurs when the trigger *source* (the signal the trigger circuit is monitoring) passes through a specified voltage level in the specified direction (the trigger slope).

Advanced triggers are a collection of trigger types that are primarily used with digital signals to detect specific conditions. The *glitch*, *runt*, *width*, *transition*, and *timeout* types trigger on unique properties of pulses that you can specify. The *pattern* and *state* types trigger on logic combinations of several signals. The *setup/hold* type triggers on the relative timing between two signals. The advanced triggers are available on the A (Main) trigger only.

Comm (Option SM only) is a special trigger used on communication signals. You may use Comm triggers to test communications signals, and Mask testing automatically uses Comm triggers to set up signals for mask testing.

Trigger Modes

The trigger mode determines how the oscilloscope behaves in the absence of a trigger event:

Normal trigger mode enables the oscilloscope to acquire a waveform only when it is triggered. If no trigger occurs, the oscilloscope will not acquire a waveform, rather the last waveform record acquired remains “frozen” on the display. If no last waveform exists, none is displayed. See Figure 3-19, *Normal trigger mode*. (You can push FORCE TRIGGER, in the Trigger control window, to force the oscilloscope to make a single acquisition.)

Auto trigger mode (automatic mode) enables the oscilloscope to acquire a waveform even if a trigger does not occur. Auto mode uses a timer that starts after a trigger event occurs. If another trigger event is not detected before the timer times out, the oscilloscope forces a trigger. The length of time it waits for a trigger event depends on the time base setting.

Be aware that auto mode, when forcing triggers in the absence of valid triggering events, does not synchronize the waveform on the display. See Figure 3-19, *Automatic trigger mode*. In other words, successive acquisitions will not be triggered at the same point on the waveform; therefore, the waveform will appear to roll across the screen. Of course, if valid triggers occur the display will become stable on screen.

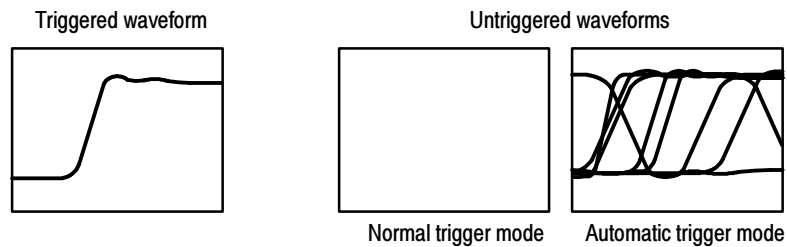

Figure 3-19: Triggered versus untriggered displays

Trigger Holdoff

Trigger holdoff can help stabilize triggering. When the oscilloscope recognizes a trigger event, it disables the trigger system until acquisition is complete. In addition, the trigger system remains disabled during the holdoff period that follows each acquisition. You adjust holdoff to obtain stable triggering when the oscilloscope is triggering on undesired trigger events as shown in Figure 3-20.

A digital pulse train is a good example of a complex waveform. (See Figure 3-20.) Each pulse looks like any other, so many possible trigger points exist. Not all of these will result in the same display. The holdoff period allows the oscilloscope to trigger on the correct edge, resulting in a stable display.

Holdoff is adjustable from 250 ns (minimum holdoff available) to 12 seconds (maximum holdoff available). To see how to set holdoff, see *To Set Holdoff* on page 3-64.

You can also set a default holdoff. The default holdoff is the general purpose holdoff for most applications and varies with the horizontal scale. It is equal to 5 divisions times the current time/division setting.

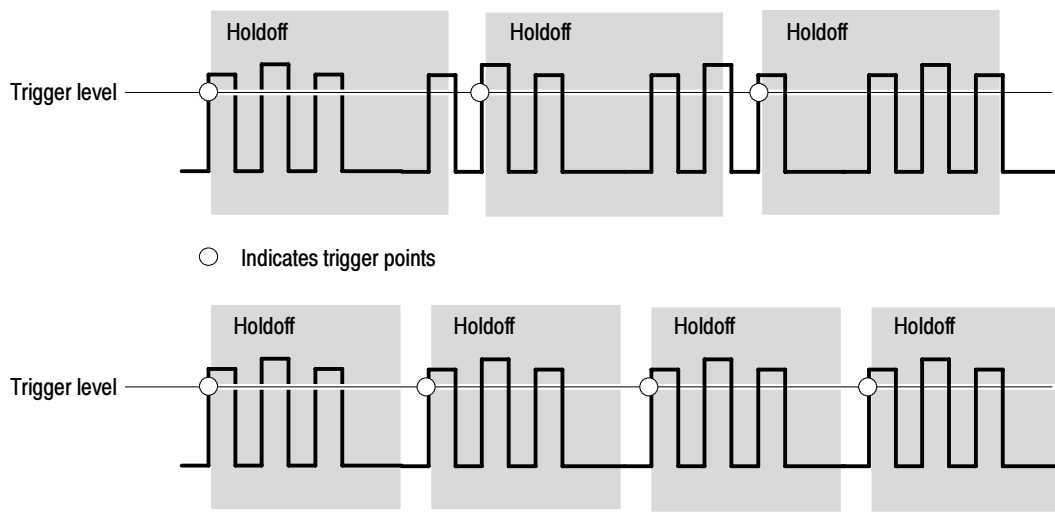

At the longer holdoff time for the top waveform, unstable triggering occurs. With a shorter holdoff set for the bottom waveform, triggers all occur on the first pulse in the burst to remedy the unstable trigger.

Figure 3-20: Holdoff adjustment can prevent false triggers

Trigger Coupling

Trigger coupling determines what part of the signal is passed to the trigger circuit. Edge triggering can use all available coupling types: AC, DC, Low Frequency Rejection, High Frequency Rejection, and Noise Rejection. All the advanced trigger types use only DC coupling. See *To Set the Trigger Coupling* on page 3-61 for a description of each coupling type.

Horizontal Position

Horizontal position is adjustable and defines where on the waveform record the trigger occurs. It lets you choose how much the oscilloscope acquires before and after the trigger event. The part of the record that occurs *before* the trigger is the pretrigger portion. The part that occurs *after* the trigger is the posttrigger portion.

When horizontal delay is off, the reference marker shows the trigger position in the waveform.

Displaying pretrigger information can be valuable when troubleshooting. For example, if you are trying to find the cause of an unwanted glitch in your test circuit, you can trigger on the glitch and make the pretrigger period large enough to capture data before the glitch. By analyzing what happened before the glitch, you may uncover clues about its source.

Slope and Level

The slope control determines whether the oscilloscope finds the trigger point on the rising or the falling edge of a signal. (See Figure 3-21.)

You set trigger slope by pushing the SLOPE button on the front panel to toggle between the positive-going and negative-going edge.

The level control determines where on that edge the trigger point occurs. (See Figure 3-21.) You can set the trigger level with the LEVEL knob on the front panel. Push the LEVEL knob to automatically set the trigger level to the 50% amplitude point of the signal.

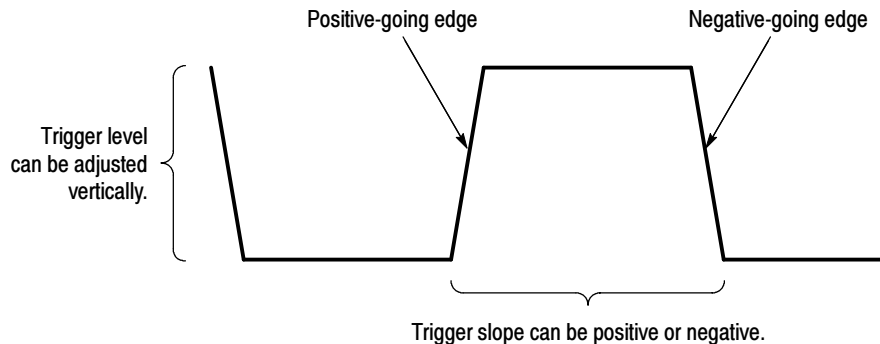

Figure 3-21: Slope and level controls help define the trigger

Delayed Trigger System

You can trigger with the A (Main) trigger system alone or you can combine the A (Main) trigger with the B (Delayed) trigger to trigger on sequential events. When using sequential triggering, the A trigger event arms the trigger system and then the B trigger event triggers the oscilloscope when the B trigger conditions are met. A and B triggers can (and typically do) have separate sources. The B trigger condition can be based on a time delay or a specified number of counted events. See *Sequential Triggering* on page 3-92 to learn how to use the delayed trigger system.

Triggering from the Front Panel

The front panel provides quick access to the most frequently used trigger controls. The trigger readout shows you the state of the trigger system.

The slope, coupling, and source controls only work for edge triggering. To access the advanced trigger controls, display the Trigger Control window by pushing the ADVANCED button (See *Advanced Triggering* on page 3-68 for more information).

Access Procedures

Use the procedure that follows when setting up the oscilloscope to trigger using the front-panel controls.

Overview	Triggering from the front panel	Control elements & resources
----------	---------------------------------	------------------------------

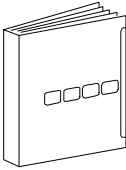
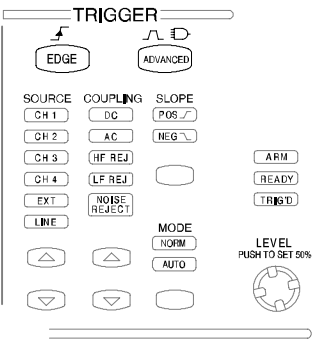
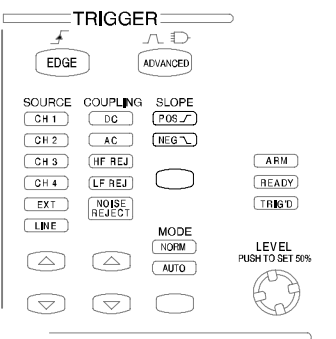
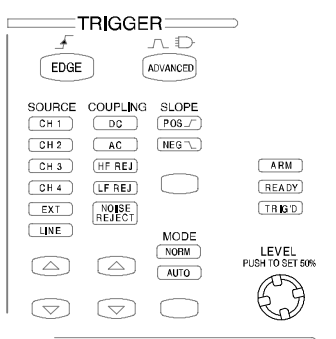
Overview	Triggering from the front panel	Control elements & resources
<p>Prerequisites</p>	<p>1. The oscilloscope must be installed and operating. Acquisition system should be set to Run, and the vertical and horizontal controls should be set appropriately for the signal to be acquired.</p>	 <p>See page 3-21 for acquisition setup</p>
<p>To select the trigger type</p>	<p>2. Push the EDGE button to select edge type triggering. Push ADVANCED to bring up the Trigger control window where you can select and set up other trigger types.</p>	
<p>To select the trigger slope</p>	<p>3. Push the TRIGGER SLOPE button to toggle between POS and NEG:</p> <ul style="list-style-type: none"> ■ POS triggers on a rising edge (positive going) signal ■ NEG triggers on a falling edge (negative going) signal <p>You can also set the slope in the Trigger control window.</p>	
<p>To set level</p>	<p>4. To manually change the trigger level when edge triggering (or certain threshold levels when logic or pulse triggering), turn the trigger LEVEL knob. You can also set the level in the Trigger control window.</p>	

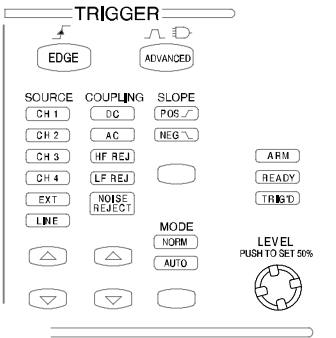
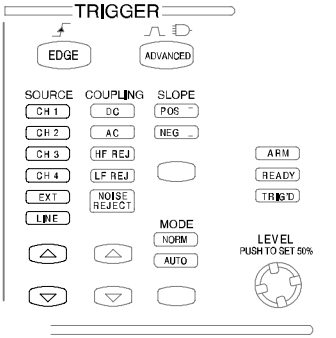
Overview	Triggering from the front panel	Control elements & resources
<p>To set to 50%</p>	<p>5. To quickly obtain an edge, glitch, or width trigger, push the trigger LEVEL knob. The oscilloscope sets the trigger level to the halfway point between the peaks of the trigger signal. This function has no effect for the other advanced trigger types.</p> <p>You can also set the level to 50% in the Trigger control window.</p> <p>When the phased locked loop is active (Comm Trigger only), pushing the trigger LEVEL knob recycles the clock-recovery trigger circuit. The instrument will attempt to acquire lock once. If the input data is disrupted, removed, or heavily distorted, the instrument may not acquire lock or may lose lock. If the recovered clock is not locked to the incoming data, the waveform display will not be stable. Once the input data is available, press the PUSH TO SET 50% knob to force the instrument to reacquire lock.</p> <p>When using Comm triggering, pushing the trigger PUSH TO SET 50% knob sets the levels for the selected code.</p>	
<p>To select the trigger source</p>	<p>6. Push the up and down arrow buttons to toggle through the possible trigger sources:</p> <ul style="list-style-type: none"> ■ <i>CH 1 - CH 4</i> are the input channels. The channel you select as a trigger source will function whether it is displayed or not. ■ <i>LINE</i> is the AC Line Voltage. Because the oscilloscope generates the trigger, you do not have to input a signal to create the trigger. ■ <i>AUX</i> is a fifth, nondisplayable trigger source. To use the auxiliary trigger, connect the external triggering signal to the Auxiliary Trigger input connector on the front panel. 	

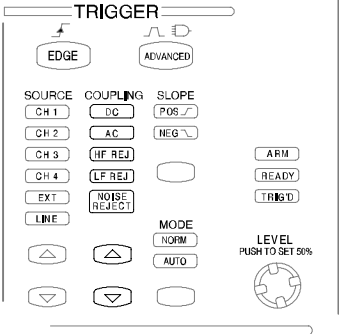
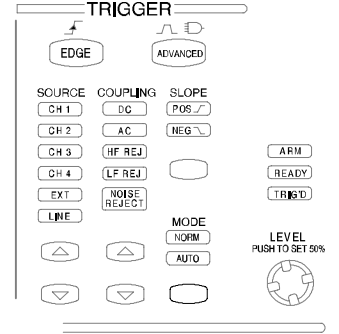
Overview	Triggering from the front panel	Control elements & resources
<p>To set the trigger coupling</p>	<p>7. Push the up and down arrow buttons to toggle through the possible trigger couplings:</p> <ul style="list-style-type: none"> ■ <i>DC</i> passes all (both AC and DC components) of the input signal. ■ <i>AC</i> passes only the AC components of an input signal. ■ <i>HF REJ</i> attenuates signals above 30 kHz. ■ <i>LF REJ</i> attenuates signals below 80 kHz. ■ <i>NOISE REJ</i> provides lower sensitivity, reducing the chance of falsely triggering on noise. 	 <p>The diagram shows the TRIGGER control panel with the following settings: SOURCE (CH 1), COUPLING (DC), SLOPE (POS), and MODE (NORM). The TRIGGER MODE button is highlighted with a white background.</p>
<p>To select the trigger mode</p>	<p>8. Push the TRIGGER MODE button to toggle between NORMAL and AUTO trigger modes:</p> <ul style="list-style-type: none"> ■ <i>NORMAL</i> trigger mode requires a trigger to acquire a waveform. ■ <i>AUTO</i> trigger mode acquires a waveform even if a trigger does not occur (after a time out). <p>Be aware that in <i>AUTO</i> mode, the acquired waveforms may not be triggered.</p>	 <p>The diagram shows the TRIGGER control panel with the following settings: SOURCE (CH 1), COUPLING (DC), SLOPE (POS), and MODE (AUTO). The TRIGGER MODE button is highlighted with a white background.</p>

To Check Trigger Status To see the state and setup of the triggering circuit, use the trigger status lights, readout, and screen.

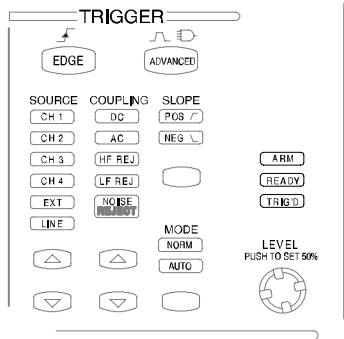
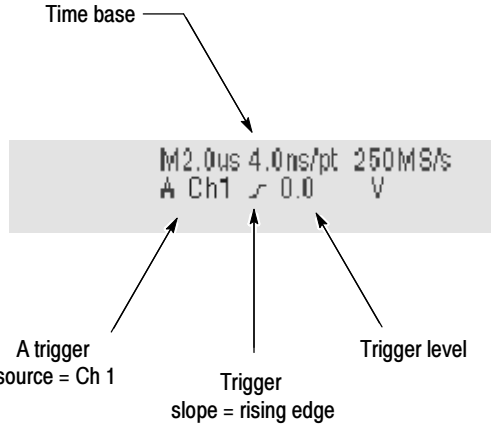
Overview	To check trigger status	Control elements & resources
<p>Trigger status from trigger status lights</p>	<p>1. To quickly determine trigger status, check the three status lights TRIG'D, READY, and ARM in the Trigger control area.</p> <ul style="list-style-type: none"> ■ TRIG'D on: the oscilloscope has recognized a valid trigger and is filling the posttrigger portion of the waveform. ■ READY on: the oscilloscope can accept, and is waiting for, a valid trigger to occur. ■ ARM on: the trigger circuitry is filling the pretrigger portion of the waveform record. ■ TRIG'D and READY on: valid A trigger recognized, waiting for a delayed trigger. When a delayed trigger is recognized, the posttrigger portion of the delayed waveform will fill. ■ ARM, TRIG'D, and READY off: the digitizer is stopped. 	 <p>The screenshot shows the TRIGGER control panel with the following settings: SOURCE (CH 1), COUPLING (DC), SLOPE (POS), CH 2 (AC), CH 3 (HF REJ), CH 4 (LF REJ), EXT (NOISE), LINE (RESIST), MODE (NORM), and AUTO. Status lights for ARM, READY, and TRIG'D are visible on the right side.</p>
<p>Trigger status from acquisition readout</p>	<p>2. To quickly determine the settings of some key trigger parameters, check the Trigger readout at the bottom of the display. The readouts differ for edge and the advanced triggers.</p>	 <p>The screenshot shows the Trigger readout with the following parameters: Time base (M2.0us 4.0ns/pt 250MS/s), A trigger source = Ch 1, Trigger slope = rising edge, and Trigger level (0.0 V).</p>

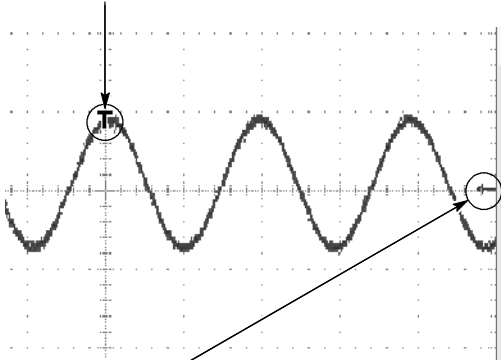
Overview	To check trigger status	Control elements & resources
<p>Trigger location and level from display</p>	<p>3. To see the trigger point and level on the waveform display, check the graphic indicators <i>Trigger Point</i> and <i>Trigger Level Indicator</i>.</p> <p>Both the trigger point indicator and level bar are displayed from the Display menu. See <i>Customizing the Display</i> on page 3-114 for more information.</p> <p>The trigger point indicator shows horizontal position. It can be positioned horizontally off screen when horizontal delay is on. The trigger level indicator shows only the trigger level. It remains on screen, regardless of the horizontal position, as long as the channel providing the trigger source is displayed. You can choose between two types of trigger level indicators: a horizontal bar or an arrow at the right side of the graticule.</p>	<p>Trigger point indicator shows the trigger position on the waveform record</p>  <p>Trigger level indicator shows the trigger level on the waveform record. You can drag the indicator to set the trigger level.</p>

Additional Trigger Parameters

Some additional trigger parameters are accessible only through the Trigger control window:

- Holdoff
- Trigger level presets
- Force trigger
- Single sequence

Use the procedures that follow to set up these additional trigger parameters. For more information, display online help while performing the procedure.

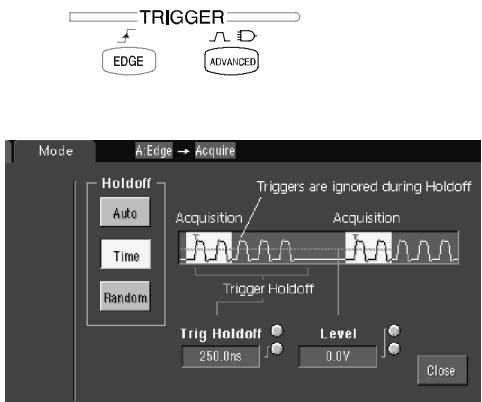
Overview	Additional trigger parameters	Control elements & resources
<p>To set holdoff</p>	<p>You can change the holdoff time to help stabilize triggering. See <i>Trigger Modes</i> and <i>Trigger Holdoff</i> beginning on page 3-55 for a description of trigger holdoff. To set holdoff, do the following steps:</p> <ol style="list-style-type: none"> 1. Push the ADVANCED button, and select the Mode tab. 2. Select Auto, Time, or Random: <ul style="list-style-type: none"> ■ The Auto holdoff is random when A only, Edge triggering is selected; otherwise, the holdoff varies with the horizontal scale and is equal to 5 divisions times the current time/division setting. Auto maintains a good value for general purpose triggering. ■ Time lets you enter a holdoff that may allow more stable triggering than the Auto holdoff. This time is used at all horizontal scale settings. ■ Random selects a new random holdoff time for each acquisition cycle. 3. To change the holdoff time when Time is selected, select Trig Holdoff, and enter a value in time using the multipurpose knob or the keypad. <p>You can set holdoff from 250 ns (minimum holdoff available) to 12 s (maximum available).</p>	 <p>The diagram shows the TRIGGER control window with two buttons: EDGE and ADVANCED. Below it is a screenshot of the Mode window. The Mode window has a 'Mode' dropdown set to 'A:Edge' and 'Acquire' mode. On the left, there is a 'Holdoff' menu with 'Auto', 'Time', and 'Random' options. The 'Auto' option is selected. The main display shows a waveform with 'Acquisition' and 'Trigger Holdoff' regions. A note says 'Triggers are ignored during Holdoff'. At the bottom, there are controls for 'Trig Holdoff' (set to 250.0ns) and 'Level' (set to 0.0V), along with a 'Close' button.</p>

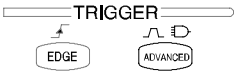
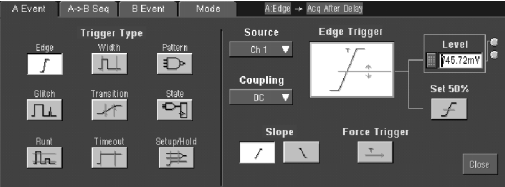
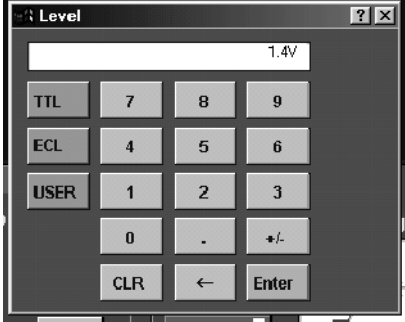
Overview	Additional trigger parameters	Control elements & resources
<p>To select a preset trigger level</p>	<ol style="list-style-type: none"> 1. Push the ADVANCED button, and select the A Event tab. 2. Select a Trigger Type, such as Edge, that uses a level adjustment. 3. Select Level and click the keyboard icon to display the keyboard. Select either TTL, ECL, or USER: <ul style="list-style-type: none"> ■ TTL fixes the trigger level at +1.4 V. ■ ECL fixes the trigger level at -1.3 V. ■ USER fixes the trigger level at the USER preset voltage. <p>When you set the volts/div smaller than 200 mV, the oscilloscope reduces the TTL or ECL trigger levels below standard TTL and ECL levels. This reduction occurs because the trigger level range is fixed at ± 12 divisions from the center. At 100 mV (the next smaller setting after 200 mV) the trigger range is ± 1.2 V, which is smaller than the typical TTL (+1.4 V) or ECL (-1.3 V) level.</p> 	  

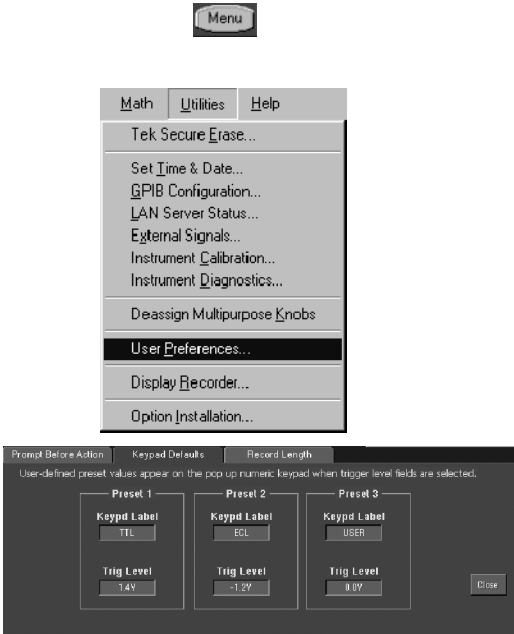
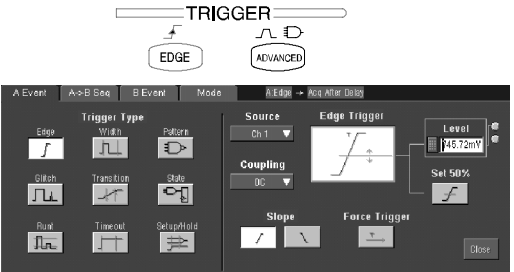
Overview	Additional trigger parameters	Control elements & resources
<p>To define new trigger level presets</p>	<ol style="list-style-type: none"> If the Menu Bar is not displayed, touch the Menu button to display the Menu Bar. Touch Utilities, and select User Preferences to display the User Preferences control window. Select the Keypad Defaults tab. Select a Trigger Level, and adjust the Trigger Level preset using the multipurpose knob or keypad. Select a Keypad Label, and change the label of the preset using the keypad. 	 <p>The top image shows a 'Menu' button and a dropdown menu with 'User Preferences...' highlighted. The bottom image shows the 'Keypad Defaults' window with three presets: Preset 1 (TTL, 1.4V), Preset 2 (ECL, -1.2V), and Preset 3 (USER, 0.0V).</p>
<p>To force a trigger</p>	<ol style="list-style-type: none"> Push the ADVANCED front-panel button to display the trigger control window. Select the A Event or B Event tab, and select the Edge trigger type. To force the oscilloscope to immediately acquire one waveform record even without a trigger event, touch the Force Trigger button. <p>Forcing a trigger is useful when in normal trigger mode and the input signal is not supplying a valid trigger. By touching Force Trigger, you can quickly confirm that there is a signal present for the oscilloscope to acquire. Once that is established, you can determine how to trigger on it (push PUSH TO SET 50%, check trigger source setting, and so on).</p> <p>The oscilloscope recognizes and acts on Force Trigger even when you touch it before the end of pretrigger holdoff. However, the button has no effect if the acquisition system is stopped.</p>	 <p>The top image shows the 'TRIGGER' control window with 'EDGE' and 'ADVANCED' buttons. The bottom image shows the 'Edge Trigger' configuration window with 'Force Trigger' button highlighted.</p>

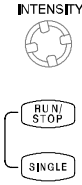
Overview	Additional trigger parameters	Control elements & resources
<p>To single trigger</p>	<ol style="list-style-type: none"> <li data-bbox="362 365 950 485">1. To trigger on the next valid trigger event and then stop, push the SINGLE front-panel button. Push the SINGLE button each time you want to initiate the single sequence of acquisitions. <li data-bbox="362 510 906 569">2. To leave Single Trigger mode, push the front-panel RUN/STOP button. <p data-bbox="407 594 963 961">The exact function of the SINGLE button depends on the acquisition mode. In Sample, Peak Detect, or Hi Res acquisition modes, acquisition stops after a single waveform is acquired. In Average or Envelope acquisition modes, acquisition stops after N waveforms are acquired, where N is the number of averages or envelopes specified. In equivalent time, it takes several triggers to partially fill a record. In Waveform Database mode, acquisition stops after N samples are acquired, where N is the number of samples specified. It may take a number of sequences of acquisitions to fill a waveform to the desired number of samples.</p> <p data-bbox="407 987 898 1045">Single sequence triggering is not available in Fast Acquisition mode.</p>	 <p>The diagram shows three control elements. At the top is a circular button labeled 'INTENSITY' with a four-pointed star icon. Below it is a rectangular button labeled 'RUN/STOP' with a curved line on its left side. At the bottom is another rectangular button labeled 'SINGLE' with a curved line on its left side, connected to the 'RUN/STOP' button.</p>

Advanced Triggering

The oscilloscope can trigger on glitch or runt pulses, or it can trigger based on the width, slew rate, or timeout period of a pulse. These capabilities make the oscilloscope suitable for such tasks as unattended monitoring for, and capturing of, a power supply glitch or GO/NO GO slew rate testing of operational amplifiers. This subsection describes how to use advanced triggers: *glitch*, *runt*, *width*, *transition* (slew rate), and *timeout* triggering.

The oscilloscope can also trigger on a logic or binary pattern and on the state of a logic pattern at the time it is clocked. The oscilloscope can trigger on data that violates setup and hold times relative to a clock. This subsection also describes how to use the advanced triggers: *pattern*, *state*, and *setup/hold*.

You can check the advanced trigger status in the readout. The readout indicates the trigger type and then shows sources, levels, or any other parameters that are important for the particular trigger type. Figure 3-22 shows an example readout for the state trigger type.

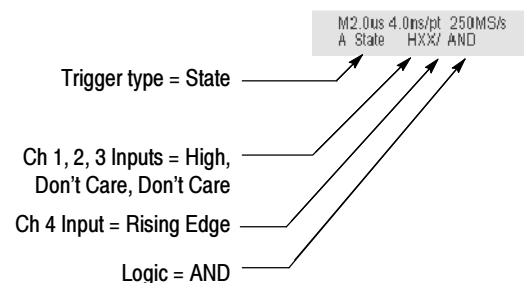

Figure 3-22: Example advanced trigger readout

Read the following topics; they provide details that can help prevent false steps in setting up to trigger on your waveforms.

Glitch Trigger. A *glitch* trigger occurs when the trigger source detects a pulse narrower (or wider) than some specified time. It can trigger on glitches of either polarity. Or you can set the glitch trigger to reject glitches of either polarity.

Runt Trigger. A *runt* trigger occurs when the trigger source detects a short pulse that crosses one threshold but fails to cross a second threshold before recrossing the first. You can set the oscilloscope to detect any positive or negative runt pulse, or only those wider than a specified minimum width.

Width Trigger. A *width* trigger occurs when the trigger source detects a pulse that is inside or, optionally, outside some specified time range (defined by the upper limit and lower limit). The oscilloscope can trigger on positive or negative width pulses.

Transition Trigger. A *transition* (slew rate) trigger occurs when the trigger source detects a pulse edge that transitions (slews) between two amplitude levels at a rate faster or slower than you specify. The oscilloscope can trigger on positive or negative transitions. You can also think of transition triggering as triggering based on the slope (change in voltage/change in time) of a pulse edge.









Timeout Trigger. A *timeout* trigger occurs when the trigger source does *not* detect an expected pulse transition. If the pulse transition occurs prior to a specified timeout time (the expected case) then no trigger results.

Pattern Trigger. A *pattern* trigger occurs when the logic inputs to the logic function you select cause the function to become TRUE (or at your option FALSE). When you use a pattern trigger, you define:

- The precondition for each logic input — logic high, low, or do not care (the logic inputs are channels 1, 2, 3, and 4)
- The Boolean logic function — select from AND, NAND, OR, and NOR
- The condition for triggering — whether the trigger occurs when the Boolean function becomes TRUE (logic high) or FALSE (logic low), and whether the TRUE condition is time qualified

The pattern (and state) logic choices are summarized in Table 3-5.

Table 3-5: Pattern and state logic

Pattern	State	Definition ^{1, 2}
 AND	 Clocked AND	If <i>all</i> the preconditions selected for the logic inputs ³ are TRUE, then the oscilloscope triggers.
 NAND	 Clocked NAND	If <i>not all</i> of the preconditions selected for the logic inputs ³ are TRUE, then the oscilloscope triggers.
 OR	 Clocked OR	If <i>any</i> of the preconditions selected for the logic inputs ³ are TRUE, then the oscilloscope triggers.
 NOR	 Clocked NOR	If <i>none</i> of the preconditions selected for the logic inputs ³ are TRUE, then the oscilloscope triggers.

- ¹ For state triggers, the definition must be met at the time the clock input changes state.
- ² The definitions given here are correct for the Goes TRUE setting in the Trigger When menu. If that menu is set to Goes False, swap the definition for AND with that for NAND and for OR with NOR for both pattern and state types.
- ³ The logic inputs are channels 1, 2, 3, and 4 when using Pattern triggers. For State triggers, channel 4 becomes the clock input, leaving the remaining channels as logic inputs.

State Trigger. A *state* trigger occurs when the logic inputs to the logic function cause the function to be TRUE (or at your option FALSE) *at the time* the clock input changes state. When you use a state trigger, you define:

- The precondition for each logic input, channels 1, 2, and 3
- The direction of the state change for the clock input, channel 4
- The Boolean logic function — select from clocked AND, NAND, OR, and NOR
- The condition for triggering — whether the trigger occurs when the Boolean function becomes TRUE (logic high) or FALSE (logic low)

The state (and pattern) logic choices are summarized in Table 3-5.

Setup/Hold Trigger. A *setup/hold* trigger occurs when a logic input changes state inside of the setup and hold times relative to the clock. When you use setup/hold triggering, you define:

- The channel containing the logic input (the data source) and the channel containing the clock (the clock source)
- The direction of the clock edge to use
- The clocking level and data level that the oscilloscope uses to determine if a clock or data transition has occurred
- The setup and hold times that together define a time range relative to the clock

Data that changes state within the setup/hold violation zone triggers the oscilloscope. Figure 3-23 shows how the setup and hold times you choose position this zone relative to the clock.

Setup/hold triggering uses the setup/hold violation zone to detect when data is unstable too near the time it is clocked. Each time trigger holdoff ends, the oscilloscope monitors the data and clock sources. When a clock edge occurs, the oscilloscope checks the data stream it is processing (from the data source) for transitions occurring within the setup/hold violation zone. If any occur, the oscilloscope triggers *with the trigger point located at the clock edge*.

Positive settings for both setup and hold times (the most common application) locate the setup/hold violation zone so it *spans* the clocking edge. (See the top waveform in Figure 3-23.) The oscilloscope detects and triggers on data that does not become stable long enough before the clock (setup time violation) or that does not stay stable long enough after the clock (hold time violation).

Negative settings for setup or hold times skew the setup/hold violation zone to locate it before or after the clocking edge. (See the bottom and center waveforms of Figure 3-23.) The oscilloscope can then detect and trigger on violations of a time *range* that occurs *before* or one that occurs *after* the clock.

NOTE. Keep the hold-time setting to no more than 2.5 ns less than one-half the clock period ($\text{hold time} \leq (\text{period}/2) - 2.5 \text{ ns}$) or the oscilloscope cannot trigger (this assumes a 50% duty cycle clock).

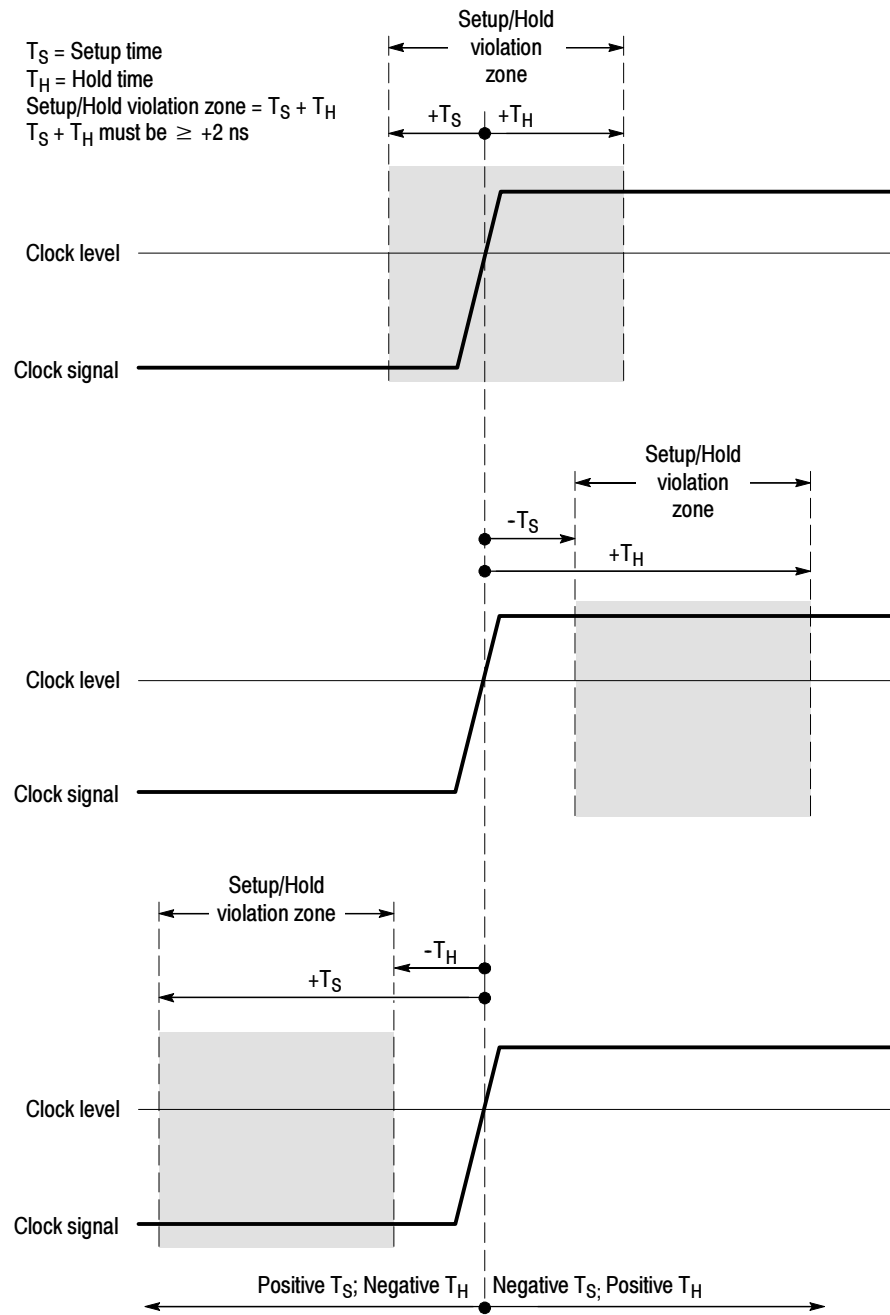
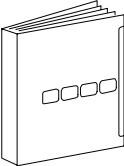
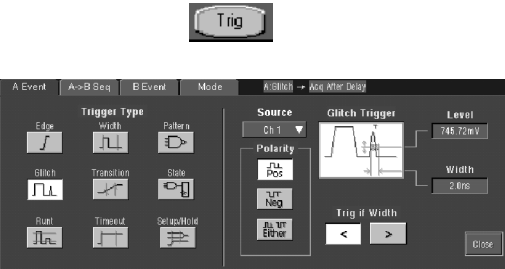
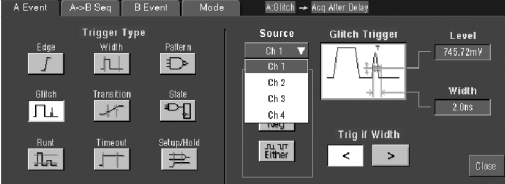

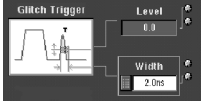

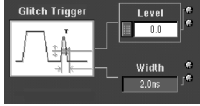
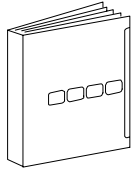

Figure 3-23: Violation zones for Setup/Hold triggering

To Trigger on a Glitch When you select the type **Glitch**, the oscilloscope will trigger on a pulse narrower (or wider) in width than some specified time. To set up for glitch triggering, do the following procedures.

Overview	To trigger on a glitch	Control elements & resources
<p>Prerequisites</p>	<p>1. The oscilloscope must be installed with a signal connected to an input channel. Acquisition system should be set to Run, and the vertical and horizontal controls should be set appropriately for the signal to be acquired.</p>	 <p>See page <3-21> for acquisition setup</p>
<p>Select glitch triggering</p>	<p>2. From the tool bar, touch Trig and select the A Event tab of the Trigger control window. 3. Touch Glitch.</p>	
<p>Select the source</p>	<p>4. To specify which channel becomes the trigger source, touch Source and select the source from the list.</p>	
<p>Select the polarity & width</p>	<p>5. To specify the glitch polarity, touch Pos (positive), Neg (negative) or Either from the Polarity window. Pos looks at positive-going pulses. Neg looks at negative-going pulses. Either looks at both positive and negative pulses.</p> <p>6. To specify the width of the glitch, touch Width, and set the glitch width using the multipurpose knob or keypad.</p>	 

Overview	To trigger on a glitch	Control elements & resources
<p>Set to trigger if width</p>	<p>7. To specify whether to trigger on glitches narrower or greater than the width you specify, touch < or >.</p> <p>Trig if Width < will trigger only on pulses narrower than the width you specified.</p> <p>Trig if Width > will trigger only on pulses wider than the specified width.</p>	
<p>Set the level</p>	<p>8. To set the Level, that the glitch must cross to be recognized by the oscilloscope touch Glitch Trigger Level and use the multipurpose knobs, keypad, or front-panel LEVEL knob to set the glitch trigger level.</p> <p>Note: you can set the level to a value appropriate to either TTL or ECL logic families. To do so touch Level and select the keypad; touch either TTL or ECL.</p>	
<p>To set mode and holdoff</p>	<p>9. Mode and holdoff can be set for all standard trigger types. To set mode and holdoff, refer to <i>To Set Holdoff</i> on page 3-64 and <i>To Select Trigger Mode</i> on page 3-61. To learn more about trigger mode and holdoff, see the descriptions <i>Trigger Modes</i> on page 3-55 and <i>Trigger Holdoff</i> on page 3-56.</p>	 <p>See <i>To Set Holdoff</i> on page 3-64 and <i>To Select Trigger Mode</i> on page 3-61 for mode and holdoff setup.</p>

To Trigger on a Runt Pulse When you select the type **Runt**, the oscilloscope will trigger on a short pulse that crosses one threshold but fails to cross a second threshold before recrossing the first. To set up for runt triggering, do the following procedures.

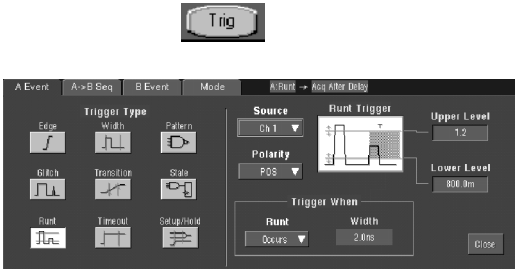
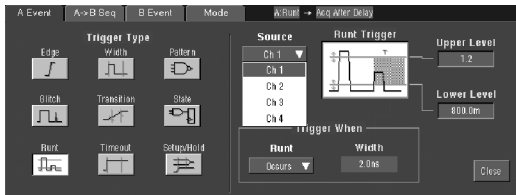
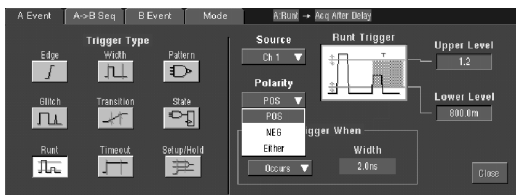
Overview	To trigger on a runt pulse	Control elements & resources
<p>Select runt triggering</p>	<ol style="list-style-type: none"> From the tool bar, touch Trig and select the A Event tab of the Trigger control window. Touch Runt. 	 <p>The screenshot shows the Trigger control window with the 'Runt' trigger type selected. The 'Source' is set to 'Ch 1', 'Polarity' is 'Pos', and 'Trigger When' is set to 'Occurs' with a width of '2.0ns'. The 'Upper Level' is 1.2 and the 'Lower Level' is 800.0m.</p>
<p>Select the source</p>	<ol style="list-style-type: none"> To specify which channel becomes the pulse trigger source, touch Source and select the source from the list. The source selected becomes the trigger source for Glitch, Runt, Width, and Transition. 	 <p>The screenshot shows the Trigger control window with the 'Source' set to 'Ch 1'. The 'Runt' trigger type is still selected, and other settings remain the same as in the previous screenshot.</p>
<p>Select the polarity</p>	<ol style="list-style-type: none"> To specify the direction of the runt pulse, touch Polarity and select Pos (positive), Neg (negative) or Either from the window. <ul style="list-style-type: none"> Pos looks at positive-going pulses. Neg looks at negative-going pulses. Either looks at both positive and negative pulses. 	 <p>The screenshot shows the Trigger control window with the 'Polarity' set to 'Pos'. The 'Runt' trigger type and other settings remain the same.</p>

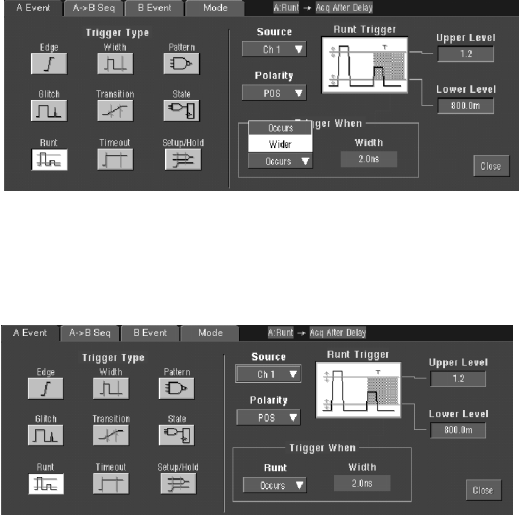
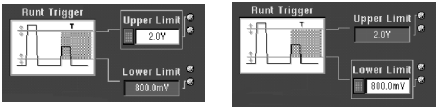
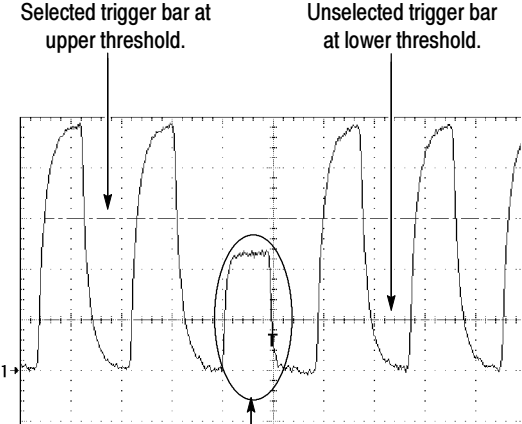
Overview	To trigger on a runt pulse	Control elements & resources
<p>Set to trigger when</p>	<p>To determine how wide a runt pulse the oscilloscope will trigger on:</p> <ol style="list-style-type: none"> 5. Touch Trigger When Runt and select from the list: <ul style="list-style-type: none"> ■ Occurs triggers on all runt pulses regardless of width. ■ Wider triggers only on runt pulses that exceed the width you set. Enter the width using the general purpose knob or keypad. 6. To specify the minimum width of the runt pulse, touch Width, and set the value using the multipurpose knob or keypad. 	
<p>Set the thresholds</p>	<ol style="list-style-type: none"> 7. To set the two threshold levels used in detecting a runt pulse, touch Upper Limit or Lower Limit and use the multipurpose knob or keypad to set the values for the upper and lower thresholds. <p>Hint: To use the trigger bar to set the threshold levels, touch the Disp button and select the Objects tab, and then touch Long to display the long trigger bar.</p> <p>Note the position of the trigger indicator. Triggering occurs at the point the pulse returns over the first (lower) threshold going negative without crossing the second threshold level (upper). The polarity selected in the Polarity window determines the order that the threshold must be crossed for a runt trigger to occur:</p> <p>Positive requires that the <i>lower</i> threshold must be first crossed going <i>positive</i>, then recrossed going <i>negative</i> without the <i>upper</i> threshold being crossed at all.</p> <p>Negative requires that the <i>upper</i> threshold must be first crossed going <i>negative</i>, then recrossed going <i>positive</i> without the <i>lower</i> threshold being crossed at all.</p> <p>Either requires only that either <i>one</i> of the thresholds must be first crossed going in <i>either</i> direction, then recrossed going in the <i>opposite</i> direction without the <i>other</i> threshold being crossed at all.</p> <p>For all three polarity settings, triggering occurs at the point the runt pulse <i>recrosses</i> its first threshold.</p>	 <p>Selected trigger bar at upper threshold. Unselected trigger bar at lower threshold.</p>  <p>Runt pulse crosses first threshold only, recrosses first threshold level, and triggers acquisition</p>

Overview	To trigger on a runt pulse	Control elements & resources
<p>To set mode and holdoff</p>	<p>8. Mode and holdoff can be set for all standard trigger types. To set mode and holdoff, refer to <i>To Set Holdoff</i> on page 3-64 and <i>To Select the Trigger Mode</i> on page 3-61. To learn more about trigger mode and holdoff, see the descriptions <i>Trigger Modes</i> on page 3-55 and <i>Trigger Holdoff</i> on page 3-56.</p>	<div data-bbox="1166 365 1289 533" style="text-align: center;"> </div> <p style="text-align: center;">See <i>To Set Holdoff</i> on page 3-64 and <i>To Select the Trigger Mode</i> on page 3-61 for mode and holdoff setup.</p>

Trigger Based on Pulse Width

When you select the type Width, the oscilloscope will trigger on a pulse narrower (or wider) than some specified *range* of time (defined by the upper limit and lower limit). To set up for width triggering, do the following procedures.

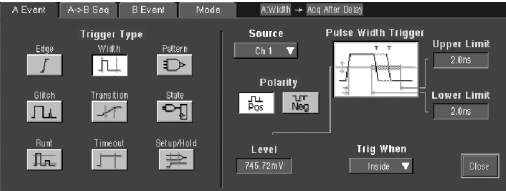
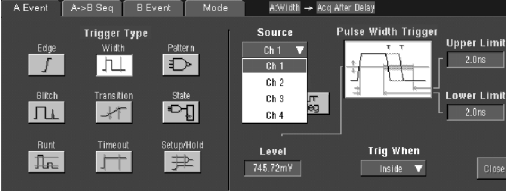
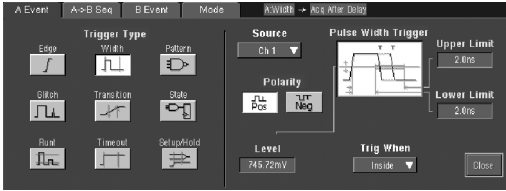
Overview	Trigger based on pulse width	Control Elements & Resources
<p>Select width triggering</p>	<p>1. From the tool bar, touch Trig and select the A Event tab of the Trigger control window. 2. Touch Width.</p>	<div data-bbox="1179 1003 1263 1045" style="text-align: center;"> </div> 
<p>Select the source</p>	<p>3. To specify which channel becomes the trigger source, touch Source and select the source from the list.</p>	
<p>Select the polarity</p>	<p>4. To specify the polarity of the pulse, touch Pos (positive) or Neg (negative) from the window. Pos looks at positive-going pulses. Neg looks at negative-going pulses.</p>	

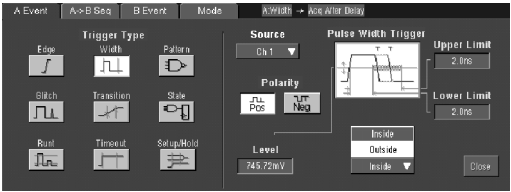
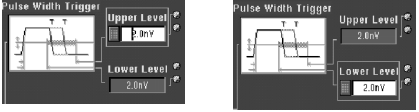
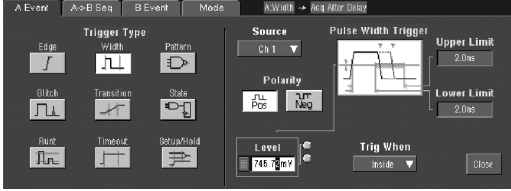
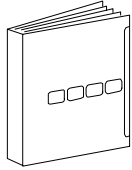
Overview	Trigger based on pulse width	Control Elements & Resources
<p>Set to trigger when</p>	<p>To set the range of widths (in units of time) the trigger source will search for and to specify whether to trigger on pulses that are outside this range or within this range, do the following steps:</p> <ol style="list-style-type: none"> 5. Touch Trigger When and select from the list: <ul style="list-style-type: none"> Inside triggers on pulses that fall within the specified range. Outside triggers on pulses that are outside the range. 6. To set the range of pulse widths in units of time, touch Upper or Lower Limit and enter the values with the general purpose knob or keypad: <ul style="list-style-type: none"> Upper Limit is the maximum valid pulse width the trigger source will look for. Lower Limit is the minimum valid pulse width. The oscilloscope will always force the Lower Limit to be less than or equal to the Upper Limit. 	 
<p>Set the level</p>	<ol style="list-style-type: none"> 7. Touch Level and use the multipurpose knob or keypad to set the trigger level. 	
<p>To set mode and holdoff</p>	<ol style="list-style-type: none"> 8. Mode and holdoff can be set for all standard trigger types. To set mode and holdoff, refer to <i>To Set Holdoff</i> on page 3-64 and <i>To Select the Trigger Mode</i> on page 3-61. To learn more about trigger mode and holdoff, see the descriptions <i>Trigger Modes</i> on page 3-55 and <i>Trigger Holdoff</i> on page 3-56. 	 <p>See <i>To Set Holdoff</i> on page 3-64 and <i>To Select the Trigger Mode</i> on page 3-61 for mode and holdoff setup.</p>

To Trigger Based on Transition Time

When you select the type Transition Time (slew rate), the oscilloscope will trigger on a pulse edge that traverses between an upper and lower threshold faster or slower than a transition time you specify. To set up for transition time triggering, do the following procedures.

Overview	To trigger based on transition time	Control elements & resources
<p>Select transition triggering</p>	<ol style="list-style-type: none"> From the tool bar, touch Trig and select the A Event tab of the Trigger control window. Touch Transition. 	
<p>Select the source</p>	<ol style="list-style-type: none"> To specify which channel becomes the trigger source, touch Source and select the source from the list. 	
<p>Select polarity</p>	<ol style="list-style-type: none"> To specify the direction of the pulse edge, touch Polarity and select Pos (positive), Neg (negative) or Either from the window: <p>Pos monitors the transition time (slew rate) of the positive-going edges of pulses. The edge must first cross the lower threshold and then cross the upper threshold.</p> <p>Neg monitors the transition time (slew rate) of the negative-going edges of pulses. The edge must first cross the upper threshold and then cross the lower threshold.</p> <p>Either monitors positive- and negative-going edges of pulses. The edge may first cross either threshold and then cross the other.</p> 	

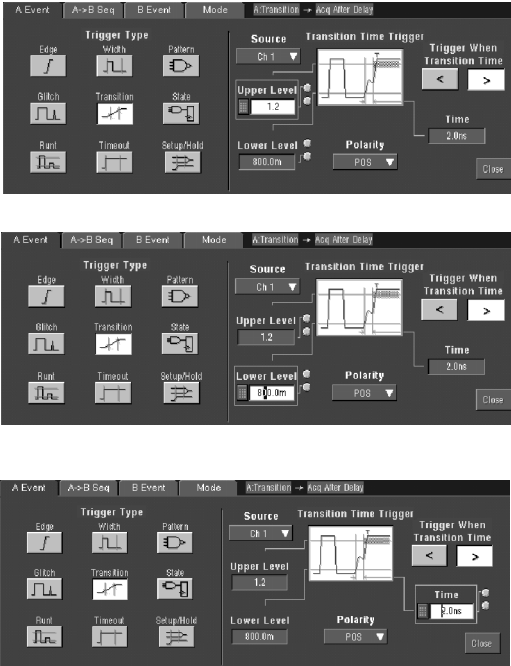
Overview	To trigger based on transition time	Control elements & resources
<p>Set the transition time</p>	<p>The threshold levels and the delta time setting determine the transition time (slew rate) setting. To set these parameters:</p> <ol style="list-style-type: none"> 5. Touch the Upper Level or Lower Level button and use the multipurpose knob or keypad to set the values for the upper and lower levels. <p>Note: you can set the level to a value appropriate to either TTL or ECL logic families. To do so touch Level and select the keypad; touch either TTL or ECL.</p> <p>Hint: To use the Trigger Bar to set the threshold levels, touch the Disp button, select the Objects tab, and then touch Long to display the long trigger bar.</p> <p>The level settings determine the voltage component of slew rate (Volts/Second). To finish specifying the slew rate (transition time), set the time component by doing the following steps:</p> <ol style="list-style-type: none"> 6. Touch Time and use the multipurpose knob or keypad to set the delta time value. 	 <p>The screenshots illustrate the configuration steps for a Transition Time Trigger. The first image shows the 'Upper Level' set to 1.2V and 'Lower Level' set to 800.0mV. The second image shows the 'Time' set to 2.0ns. The third image shows the 'Time' set to 1.0ns.</p>

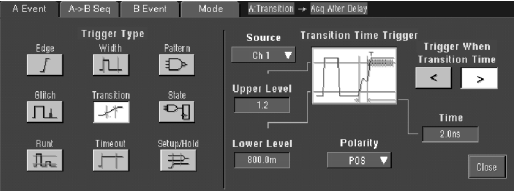
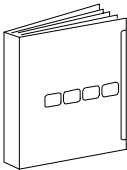
Overview	To trigger based on transition time	Control elements & resources
<p>Set to trigger when</p>	<p>The oscilloscope compares the pulse edge of the trigger source against the transition time (slew rate) set by the upper and lower threshold settings and the delta time set in the window. To select whether to trigger on edges with transitions times (slew rates) faster than or slower than that set by these controls, do the following step:</p> <p>7. Touch Trigger When Transition Time < or Trigger When Transition Time >.</p> <p>< triggers when the transition time is greater than the time you set.</p> <p>> triggers when the transition time is less than the time you set</p> <p>If you select Trigger When Transition Time > (greater than) and the oscilloscope does not trigger, it may be because the pulse edge is too fast rather than too slow. To check the edge speed, switch to edge triggering. Then trigger on the pulse edge and determine the time the edge takes to travel between the levels set in the slew rate Thresholds menu. The oscilloscope cannot transition trigger on pulse edges that traverse between threshold levels in 600 ps or less.</p> <p>Also, to reliably transition trigger, a pulse must have a width of 8.5 ns or more. A pulse of less width may trigger on the wrong slope or not trigger at all. Switch to edge triggering and check the pulse width if you can't transition trigger as expected.</p>	
<p>To set mode and holdoff</p>	<p>8. Mode and holdoff can be set for all standard trigger types. To set mode and holdoff, refer to <i>To Set Holdoff</i> on page 3-64 and <i>To Select the Trigger Mode</i> on page 3-61. To learn more about trigger mode and holdoff, see the descriptions <i>Trigger Modes</i> on page 3-55 and <i>Trigger Holdoff</i> on page 3-56.</p>	 <p>See <i>To Set Holdoff</i> on page 3-64 and <i>To Select Trigger Mode</i> on page 3-61 for mode and holdoff setup.</p>

Trigger Based on Pulse Timeout

When you select the type Timeout, the oscilloscope will trigger when a pulse transition does NOT occur within a specified time limit. That is, the trigger will occur when, depending on the polarity you select, the signal stays higher or stays lower than the trigger level for the timeout value. To set up for timeout triggering, do the following procedures.

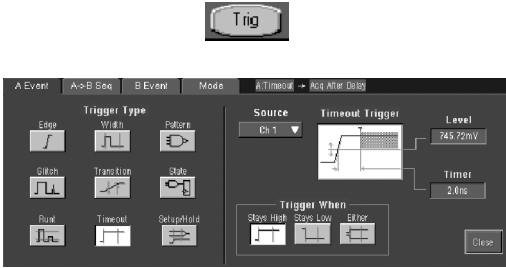
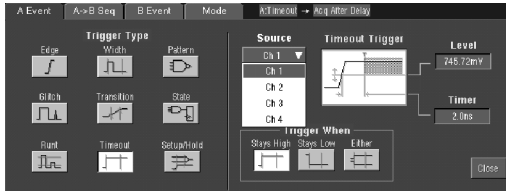
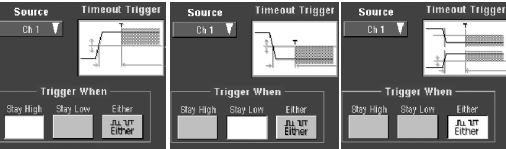
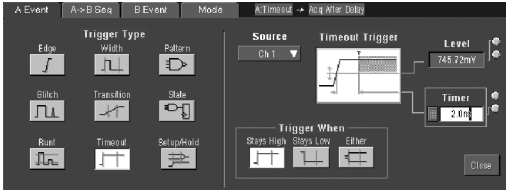
Overview	Trigger based on pulse timeout	Control elements & resources
<p>Select timeout triggering</p>	<ol style="list-style-type: none"> From the tool bar, touch Trig and select the A Event tab of the Trigger control window. Touch Timeout. 	
<p>Select the source</p>	<ol style="list-style-type: none"> To specify which channel becomes the trigger source, touch Source and select the source from the list. 	
<p>Set to trigger when</p>	<ol style="list-style-type: none"> Touch Stay High, Stay Low, or Either from the Trigger When window: <p>Stay High causes a trigger if the signal stays higher than the trigger level for longer than the timeout value.</p> <p>Stay Low causes a trigger if the signal stays lower than the trigger level for longer than the timeout value.</p> <p>Either causes a trigger if the signal stays lower or stays higher than the trigger level for longer than the timeout value.</p> 	
<p>Set the timer</p>	<ol style="list-style-type: none"> To set the timeout timer, touch Timer and use the multipurpose knob or keyboard to set the time. 	

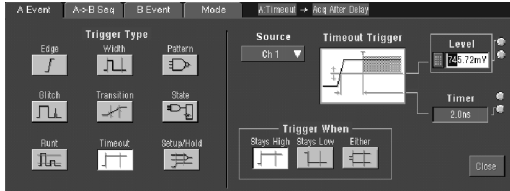
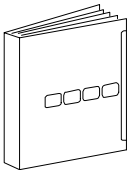
Overview	Trigger based on pulse timeout	Control elements & resources
<p>Set the level</p>	<p>6. To set the Level, touch Level and use the multipurpose knobs or keypad to set the timeout trigger level.</p> <p>Note: you can set the level to a value appropriate to either TTL or ECL logic families. To do so touch Level and select the keypad; touch either TTL or ECL.</p>	
<p>To set mode and holdoff</p>	<p>7. Mode and holdoff can be set for all standard trigger types. To set mode and holdoff, refer to <i>To Set Holdoff</i> on page 3-64 and <i>To Select the Trigger Mode</i> on page 3-61. To learn more about trigger mode and holdoff, see the descriptions <i>Trigger Modes</i> on page 3-55 and <i>Trigger Holdoff</i> on page 3-56.</p>	 <p>See <i>To Set Holdoff</i> on page 3-64 and <i>To Select the Trigger Mode</i> on page 3-61 for mode and holdoff setup.</p>

Trigger on a Pattern

When you select the type Pattern, the oscilloscope will trigger when the inputs to the logic function you select cause the function to become TRUE (or at your option FALSE). To setup pattern trigger, do the following procedures.

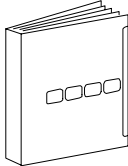
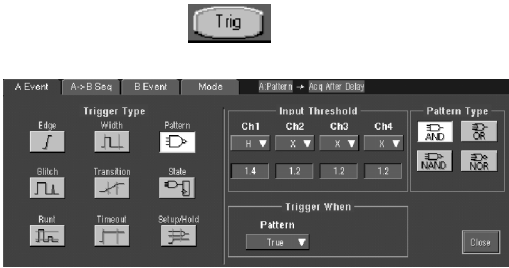
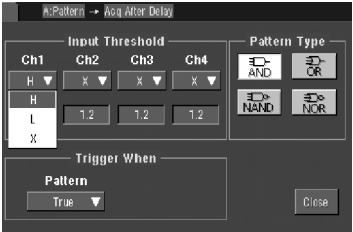
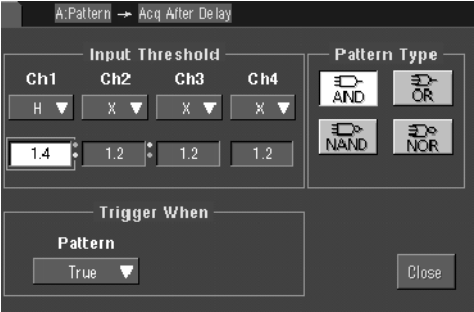
Overview	Trigger on a pattern	Control elements & resources
<p>Prerequisites</p>	<p>1. The oscilloscope must be installed and operating. Acquisition system should be set to Run, and the vertical and horizontal controls should be set appropriately for the signal to be acquired.</p>	 <p>See page <3-21> for acquisition setup</p>
<p>To Trigger on a pattern</p>	<p>2. From the tool bar, touch Trig and select the A Event tab of the Trigger control window.</p> <p>3. Touch Pattern.</p>	
<p>To define pattern inputs</p>	<p>4. To set the logic state for each of the input channels (Ch1, Ch2, . . .), touch each Input Threshold and select either High (H), Low (L), or don't care (X) from the menu.</p>	
<p>To set thresholds</p>	<p>5. To set the logic threshold for each channel, select the channel threshold and use the multipurpose knob or keypad to set each threshold.</p>	

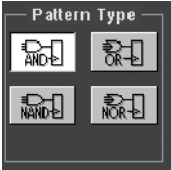
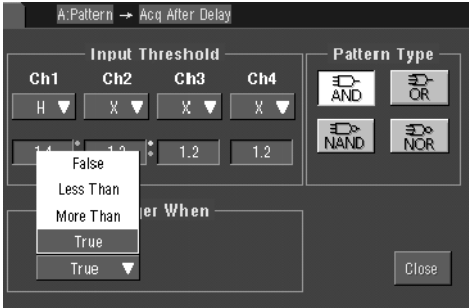
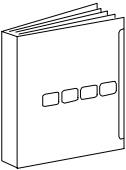
Overview	Trigger on a pattern	Control elements & resources
<p>To define the logic</p>	<p>6. To choose the logic pattern type you want applied to the input channels, touch an available type from the Pattern Type window. (See page 3-70 for definitions of the logic functions for both pattern and state triggers.)</p>	
<p>To set trigger when</p>	<p>7. To choose to trigger when the logic condition is met (goes TRUE) or when the logic condition is not met (goes FALSE), touch Trigger When Pattern and select False, Less Than, More Than, or True from the list.</p> <p>The list items More Than and Less Than are used to time qualify a pattern trigger. See the procedure <i>Define a Time Qualified Pattern Trigger</i> that follows for instructions.</p>	
<p>To set mode and holdoff</p>	<p>8. Mode and holdoff can be set for all standard trigger types. To set mode and holdoff, refer to <i>To Set Holdoff</i> on page 3-64 and <i>To Select the Trigger Mode</i> on page 3-61. To learn more about trigger mode and holdoff, see the descriptions <i>Trigger Modes</i> on page 3-55 and <i>Trigger Holdoff</i> on page 3-56.</p>	 <p>See <i>To Set Holdoff</i> on page 3-64 and <i>To Select the Trigger Mode</i> on page 3-61 for mode and holdoff setup.</p>

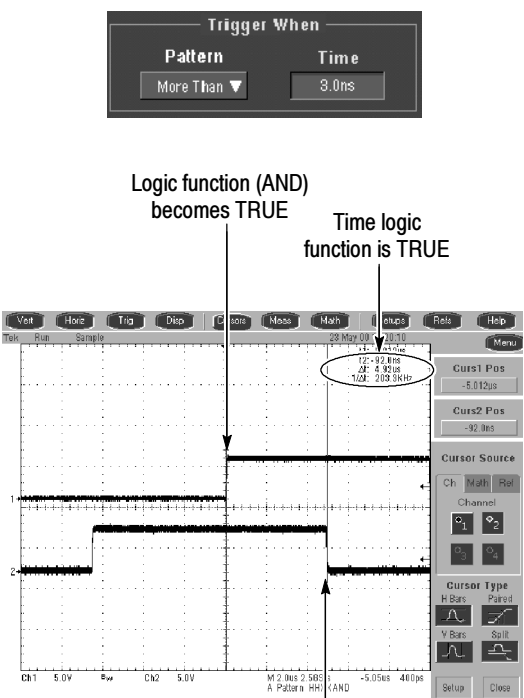
Overview	Trigger on a pattern	Control elements & resources
<p>To define a time qualified pattern trigger</p> <p>You can time qualify a pattern logic trigger. That is, you specify a time that the boolean logic function (AND, NAND, OR, or NOR) must be TRUE. To specify the time limit as well as the type of time qualification (More Than or Less Than the time limit specified) for a pattern trigger, do the following step:</p> <p>9. Select Trigger When Time and set the time using the multipurpose knob or keypad.</p> <p>When you select TRUE for Less Than and specify a time, the input conditions you specify must drive the logic function high (TRUE) for less than the time you specify. Conversely, the TRUE for More Than item requires the boolean function to be TRUE for longer than the time you specify.</p> <p>Note the position of the trigger indicator. Triggering occurs at the point that the oscilloscope <i>determines</i> that the logic function you specify is TRUE within the time you specify. The oscilloscope determines the trigger point in the following manner:</p> <ul style="list-style-type: none"> ■ It waits for the logic condition to become TRUE. ■ It starts timing and waits for the logic function to become FALSE. ■ It compares the times and, if the time TRUE is longer (for TRUE for more than) or shorter (for TRUE for less than), then it triggers a waveform display <i>at the point the logic condition became FALSE</i>. This time can be, and usually is, different from the time set. <p>In the figure, the delay between the vertical bar cursors is the time the logic function is TRUE. Since this time is more (4.9 ns) than that set in the TRUE for More Than item (3 ns), the oscilloscope issues the trigger at that point, not at the point at which it has been TRUE for 3 ns.</p>		 <p>The figure illustrates the triggering mechanism. At the top, a 'Trigger When' dialog box shows 'Pattern' set to 'More Than' and 'Time' set to '3.0ns'. Below, an oscilloscope waveform shows two channels. A vertical bar cursor marks the start of a pulse, labeled 'Logic function (AND) becomes TRUE'. Another vertical bar cursor marks the end of the pulse, labeled 'Time logic function is TRUE'. A third vertical bar cursor marks the end of the pulse, labeled 'Logic function becomes FALSE and triggers acquisition'. A text box below the waveform states 'Time Logic Function Must be TRUE = 3 ns'.</p>

To Trigger on a State When you select the type State, the oscilloscope uses channel 4 as a clock and triggers on a logic circuit made from the rest of the channels (page 3-70 describes how state triggers work). To use state triggering, do the following procedures.

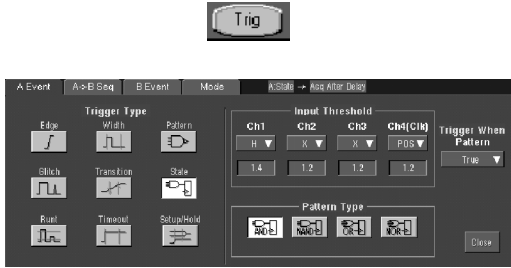
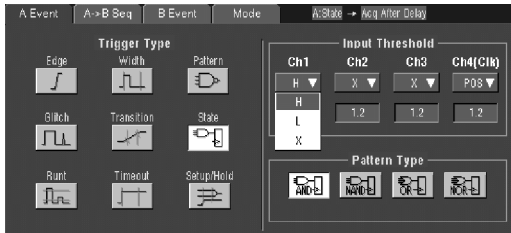
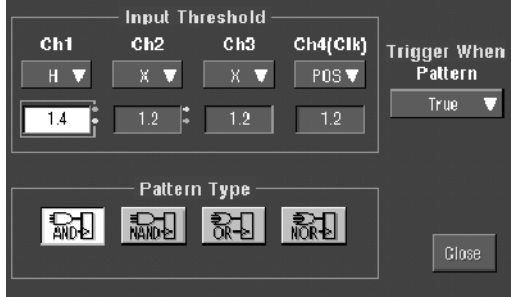
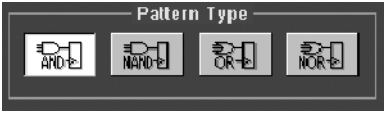
Overview	To trigger on a state	Control elements & resources
<p>Select state triggering</p>	<ol style="list-style-type: none"> From the tool bar, touch Trig and select the A Event tab of the Trigger control window. Touch State. 	
<p>Define inputs</p>	<ol style="list-style-type: none"> To set the logic state for each of the input channels (Ch1, Ch2, Ch3, and Ch4), touch each Input Threshold and select either High (H), Low (L), or don't care (X) from the menu. The choices for Ch4 are rising (POS) edge and falling (NEG) edge. 	
<p>Set thresholds</p>	<ol style="list-style-type: none"> To set the logic threshold for each channel, select the channel threshold and use the multipurpose knob or keypad to set each threshold. 	
<p>Define logic</p>	<ol style="list-style-type: none"> To choose the logic pattern type you want applied to channels 1 through 3, touch an available type from the Pattern Type window. (See page 3-70 for definitions of the logic functions for both pattern and state triggers.) 	

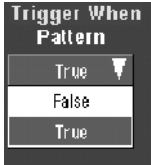
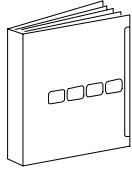

Overview	To trigger on a state	Control elements & resources
<p>Set trigger when</p>	<p>6. To choose to trigger when the logic condition is met (goes TRUE) or when the logic condition is not met (goes FALSE), touch Trigger When Pattern and select False or True from the list.</p> <p>For simplest operation, leave this control set to TRUE. Setting the control to FALSE complements the output of the chosen pattern function, for example, from AND to NAND or NOR to OR.</p>	
<p>To set mode and holdoff</p>	<p>7. Mode and holdoff can be set for all standard trigger types. To set mode and holdoff, refer to <i>To Set Holdoff</i> on page 3-64 and <i>To Select the Trigger Mode</i> on page 3-61. To learn more about trigger mode and holdoff, see the descriptions <i>Trigger Modes</i> on page 3-55 and <i>Trigger Holdoff</i> on page 3-56.</p>	 <p>See <i>To Set Holdoff</i> on page 3-64 and <i>To Select Trigger Mode</i> on page 3-61 for mode and holdoff setup.</p>

To Trigger on Setup/ Hold Time Violations

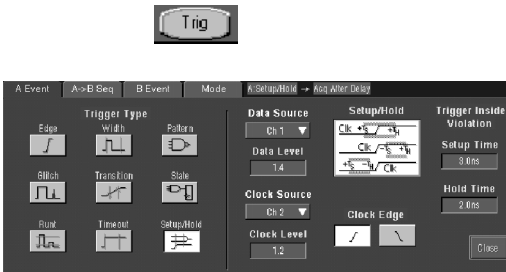
When you select the type Setup/Hold, the oscilloscope uses one channel as a data channel (the factory default setting is Ch1), another channel as a clock channel (default is Ch2), and triggers if the data transitions within the setup or hold time of the clock. (Pages 3-71 and 3-71 describe how setup/hold triggers work). To use setup and hold triggering, do the following procedures.

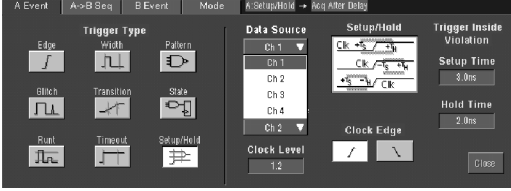
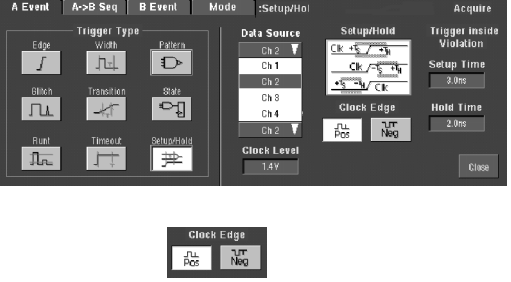
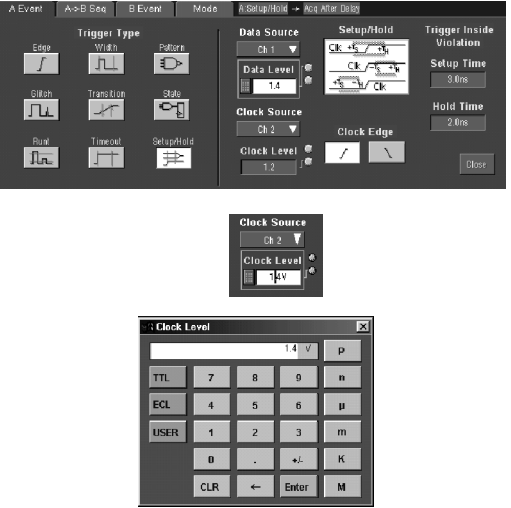
Overview	To trigger on setup/hold time violations	Control elements & resources
<p>Select setup/ hold triggering</p>	<ol style="list-style-type: none"> From the tool bar, touch Trig and select the A Event tab of the Trigger control window. Touch Setup/Hold. 	

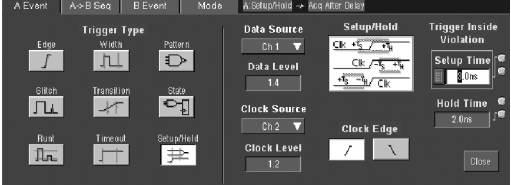
Overview	To trigger on setup/hold time violations	Control elements & resources
<p>Define the data source</p>	<p>3. To select the channel that is to contain the data signal, touch Data Source and select the source from the list. Do <i>not</i> select the same channel for both the data and clock sources.</p>	
<p>Define the clock source and edge</p>	<p>4. To select the channel that is to contain the clock signal and the edge to use to clock, touch Clock Source and select the source from the list.</p> <p>Do <i>not</i> select the same channel for both the data and clock sources.</p> <p>5. To select the edge to use to clock, select either Pos or Neg from the Clock Edge window.</p>	
<p>Set the data and clock levels</p>	<p>To set the transition levels that the clock and data must cross to be recognized by the oscilloscope:</p> <p>6. Touch Data Level and use the multipurpose knobs or keypad to set the data level.</p> <p>7. Touch Clock Level and use the multipurpose knobs or keypad to set the clock level.</p> <p>8. Note: you can set the levels to a value appropriate to either TTL or ECL logic families. To do so touch either the Data Level or Clock Level and select the keypad; touch either TTL or ECL.</p> <p>The oscilloscope uses the clock level you set to determine when a clock edge occurs. The oscilloscope uses the point the clock crosses the clock level as the reference point from which it measures setup and hold time settings.</p>	

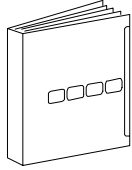
Overview	To trigger on setup/hold time violations	Control elements & resources
<p>Set the setup and hold times</p>	<p>To set the setup time and the hold time relative to the clock:</p> <ol style="list-style-type: none"> 9. Touch Setup Time and use the multipurpose knobs or keypad to set the setup time. 10. Touch Hold Time and use the multipurpose knobs or keypad to set the hold time. See Figure 3-24. <p>Positive setup time always leads the clock edge; positive hold time always follows the clocking edge. Setup time always leads the hold time by at least 2 ns ($T_S + T_H \geq 2 \text{ ns}$). <i>Attempting to set either time to reduce the 2 ns limit adjusts the other time to maintain the limit.</i></p> <p>In most cases, you will enter positive values for both setup and hold time. Positive values set the oscilloscope to trigger if the data source is still settling inside the setup time before the clock or if it switches inside the hold time after the clock. You can skew this “setup/hold violation zone” that the setup and hold times form by entering negative values. See Figure 3-23 on page 3-72.</p>	 
<p>To set mode and holdoff</p>	<ol style="list-style-type: none"> 11. Mode and holdoff can be set for all standard trigger types. To set mode and holdoff, refer to <i>To Set Holdoff</i> on page 3-64 and <i>To Select the Trigger Mode</i> on page 3-61. To learn more about trigger mode and holdoff, see the descriptions <i>Trigger Modes</i> on page 3-55 and <i>Trigger Holdoff</i> on page 3-563-55. 	 <p>See <i>To Set Holdoff</i> on page 3-64 and <i>To Select the Trigger Mode</i> on page 3-61 for mode and holdoff setup.</p>

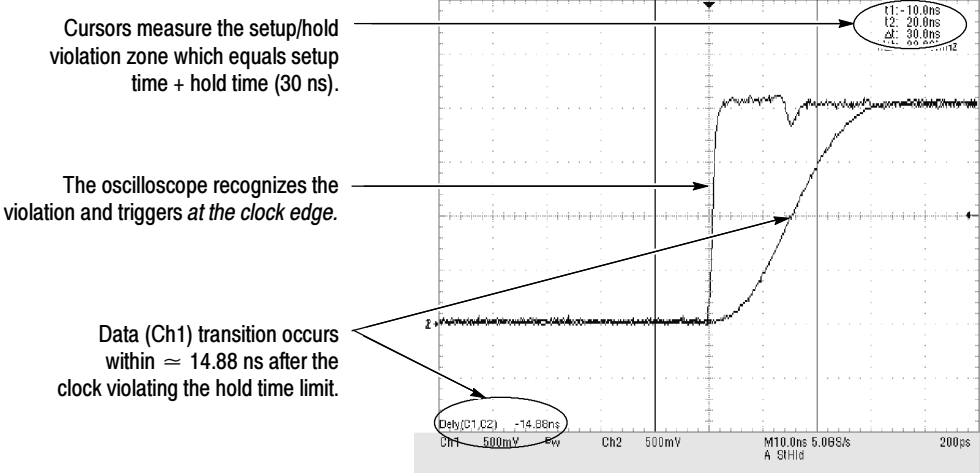

Figure 3-24: Triggering on a Setup/Hold time violation

Sequential Triggering

In applications that involve two or more signals, you may be able to use sequential triggering to capture more complex events. Sequential triggering uses the A (Main) trigger to arm the trigger system, and then uses the B (Delayed) trigger to trigger the oscilloscope if a specific condition is met. You can choose one of two trigger conditions:

- *Trig After Time:* After the A trigger arms the trigger system, the oscilloscope triggers on the next B-trigger event that occurs after the Trigger Delay Time. You can set the trigger delay time with the keypad or the multipurpose knobs.
- *Trigger on n^{th} Event:* After the A trigger arms the trigger system, the oscilloscope triggers on the n^{th} B event. You can set the number of B events with the keypad or the multipurpose knobs.

NOTE. *The traditional delayed trigger mode called “Runs After” is served by the TDS7000 feature Horizontal Delay. You can use horizontal delay to delay acquisition from any trigger event, whether from the A (Main) trigger alone or from a sequential trigger that uses both the A (Main) and B (Delayed) triggers. See Triggering with Horizontal Delay On on page 3-94 for more information.*

Using Sequential Triggering

Read the following topics; they provide details that can help prevent false steps in setting up to trigger on your waveforms.

Trigger Sources. In most cases, it makes sense to set separate trigger sources for the A (Main) and B (Delayed) triggers. Line is not available as a source for the B trigger.

Trigger Types. When using sequential triggering, the A trigger must be set to one of the following types: Edge, Glitch, or Width. The B trigger is always Edge type.

Triggering with Horizontal Delay Off. Figure 3-25 compares the sequential trigger choices A-Only, Trig After Time, and Trig on n^{th} Event when horizontal delay is off. Each illustration shows where pretrigger and posttrigger data is acquired relative to the trigger event.

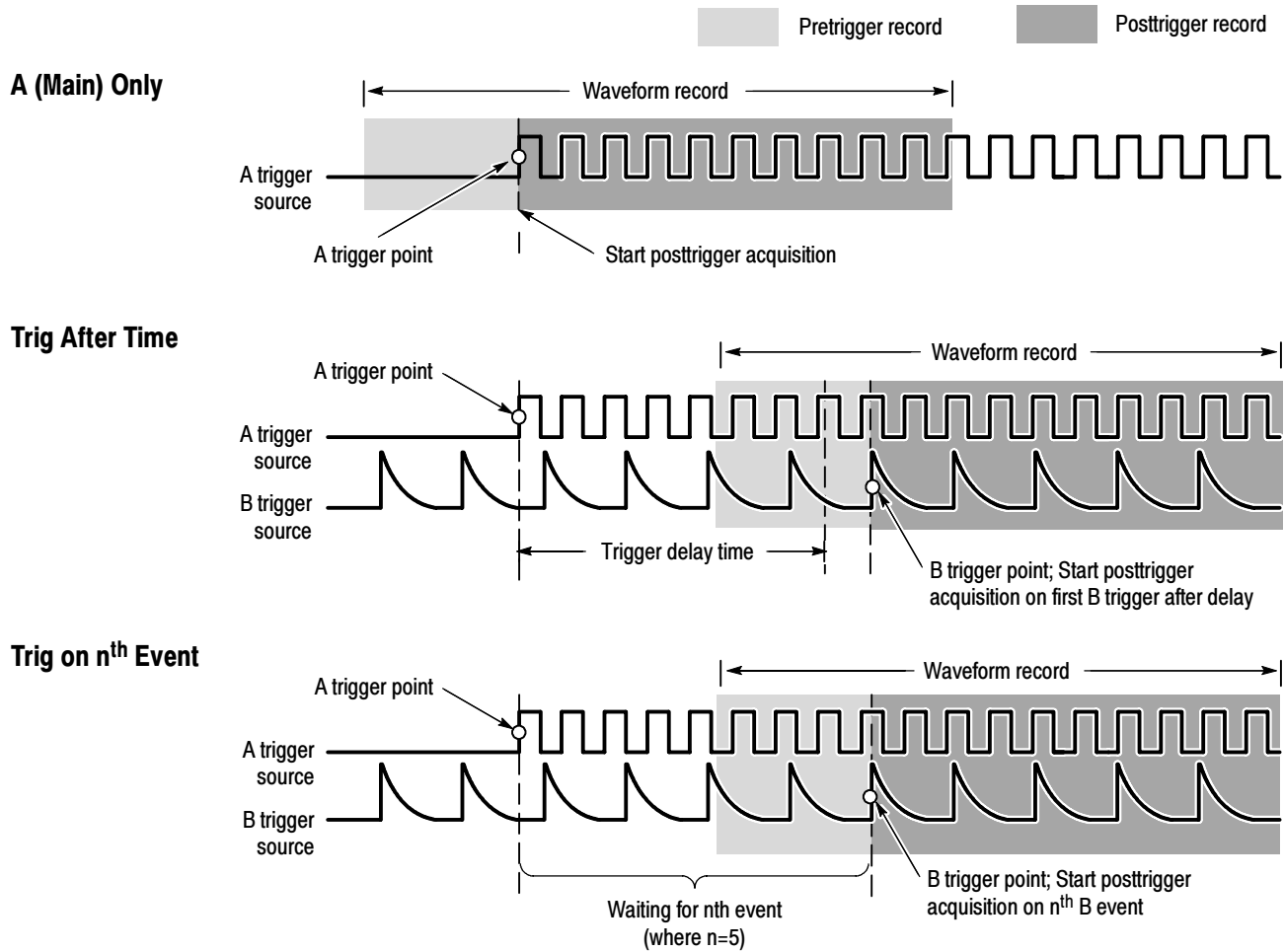

Figure 3-25: Triggering with Horizontal Delay off

Triggering with Horizontal Delay On. You can use horizontal delay when you want to acquire a waveform record that is separated from the trigger event by a significant interval of time. The horizontal delay function can be used with any trigger setup. You can turn horizontal delay on and off from the front panel, the Horizontal/Acquisition control window, and many of the Trigger control windows. Figure 3-26 compares the sequential trigger choices A-Only, Trig After Time, and Trig on n^{th} Event when horizontal delay is on. Each illustration shows where pretrigger and posttrigger data is acquired relative to the trigger event.

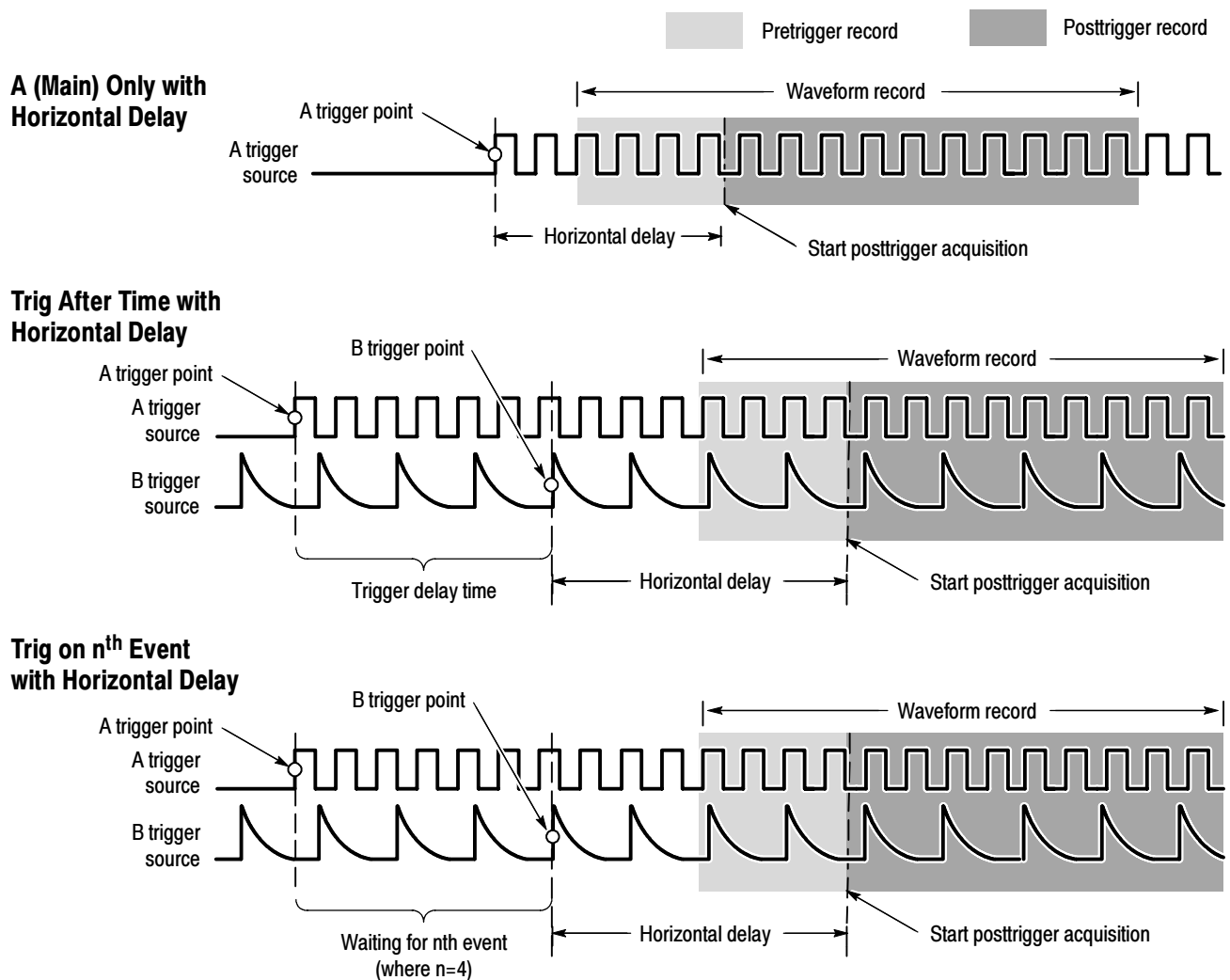

Figure 3-26: Triggering with Horizontal Delay on

The flow diagram in Figure 3-27 summarizes all combinations of triggering and horizontal delay.

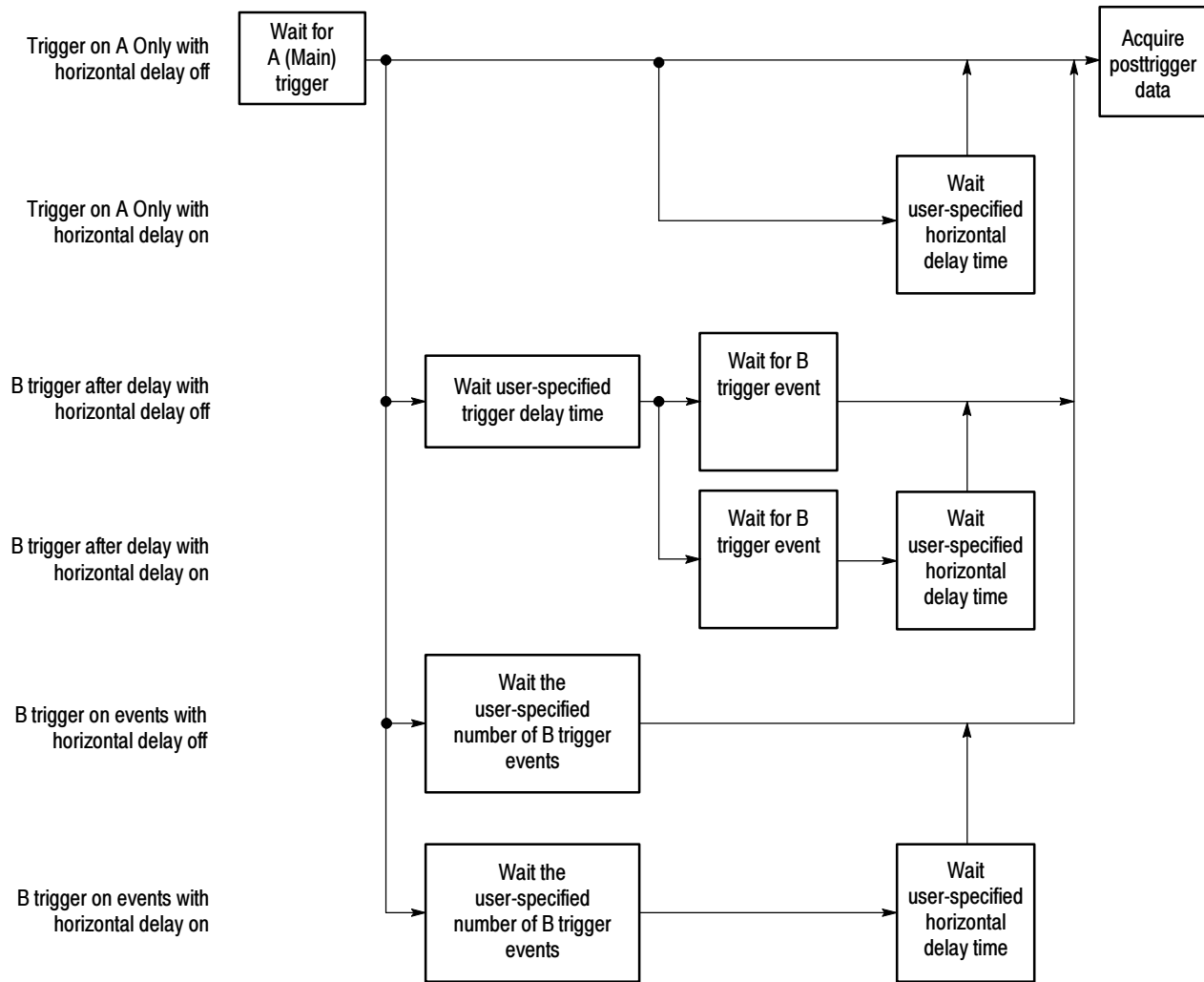
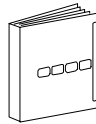

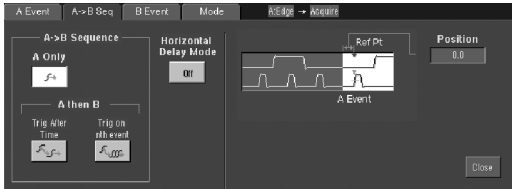

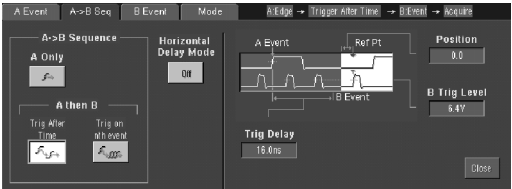
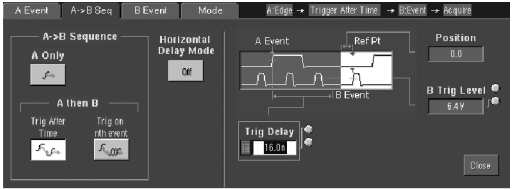
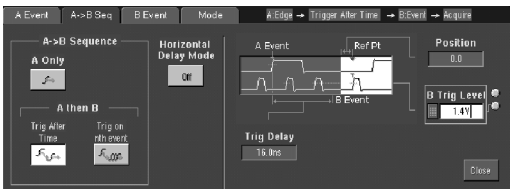

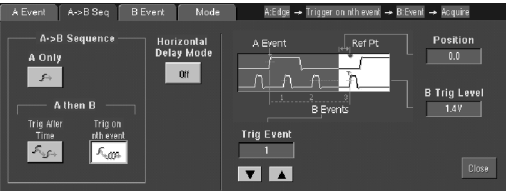
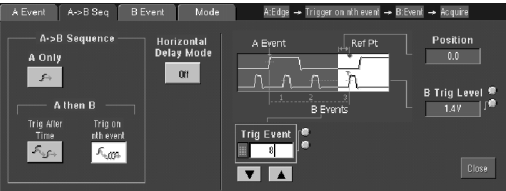
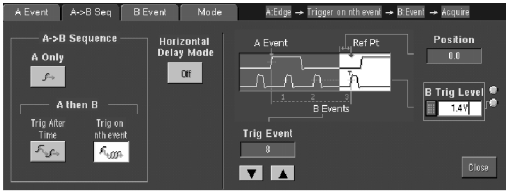

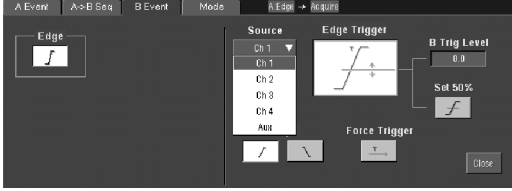
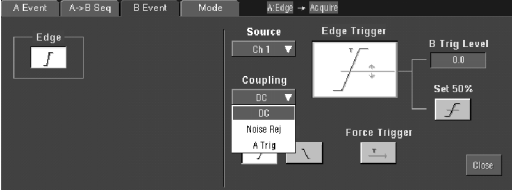
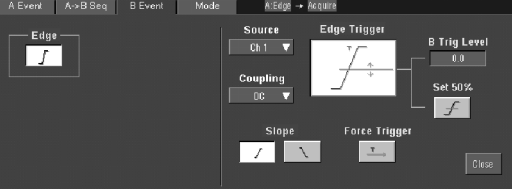
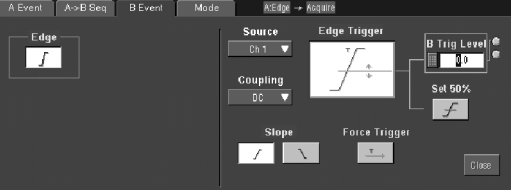



Figure 3-27: Trigger and Horizontal Delay summary

To Trigger on a Sequence Use the procedure that follows when setting up the oscilloscope to trigger on a sequence. For more information, display online help while performing the procedure.

Overview	To trigger on a sequence	Control elements & resources
<p>Prerequisites</p>	<ol style="list-style-type: none"> The oscilloscope must be installed with a signal connected to an input channel. Acquisition system should be set to Run, and the vertical and horizontal controls should be set appropriately for the signal to be acquired. 	 <p>See page <3-21> for acquisition setup</p>
<p>To trigger on a (main) only</p>	<ol style="list-style-type: none"> From the tool bar, touch Trig and select the A->B Seq tab of the Trigger control window. Touch A Only to turn off sequential triggering. 	 
<p>To trigger on b after time</p>	<ol style="list-style-type: none"> To set the time base to run after an A trigger, a trigger delay, and a B trigger, from the tool bar, touch Trig and select the A->B Seq tab of the Trigger control window Touch Trig After Time. To set the trigger delay, touch Trig Delay and use the multipurpose knob or keypad to set the time. To set the B trigger level, touch B Trig Level and use the multipurpose knob or keypad to set the level. 	   

Overview	To trigger on a sequence	Control elements & resources
<p>To trigger on b events</p>	<ol style="list-style-type: none">1. To set the time base to trigger after an A trigger and a specified number of B trigger events, from the tool bar, touch Trig and select the A->B Seq tab of the Trigger control window2. Touch A Then B Trig on nth Event3. To set the number of B trigger events, touch Trig Event and use the multipurpose knob, keyboard, or up and down arrows to set the number of events.4. To set the B trigger level, touch B Trig Level and use the multipurpose knob or keypad to set the level.	   

Overview	To trigger on a sequence	Control elements & resources
<p>To set up b triggering</p>	<ol style="list-style-type: none"> To set the B Event trigger, from the tool bar, touch Trig and select the B Event tab of the Trigger control window. To specify which channel becomes the B trigger source, touch Source and select the source from the list. Touch COUPLING and select the trigger coupling to match your trigger signal. To specify the direction of the edge, touch Slope and select Pos (positive) or Neg (negative) from the window: Pos monitors positive-going edges. Neg monitors negative-going edges. To set the B trigger level, touch B Trig Level and use the multipurpose knob or keypad to set the level. Note: you can also touch Set 50% to set the B trigger level to the midpoint between the positive and negative peak of the B trigger signal. 	    
<p>For further assistance</p>	<ol style="list-style-type: none"> Touch the Help button in the Trigger control window to access the online assistance specific to triggering commands. 	 <p>See page 3-245 for information on online assistance</p>

Comm Triggering

The oscilloscope can trigger on communication signals. For detailed information on using comm triggering to trigger on your communications signals see the *CSA7000, TDS7000 & TDS6000 Series Options SM Serial Mask Testing and Option ST Serial Triggering User Manual*.

NOTE. *The instrument will attempt to acquire lock once. If the input data is disrupted, removed, or heavily distorted, the instrument may not acquire lock or may lose lock. If the recovered clock is not locked to the incoming data, the waveform display will not be stable. Once the input data is available, press the PUSH TO SET 50% knob to force the instrument to reacquire lock.*

Displaying Waveforms

This oscilloscope includes a flexible, customizable display that you can control to display the waveforms you acquire. This section presents the following topics:

- *Using the Waveform Display*
- *Setting Zoom Controls*
- *Customizing the Display*

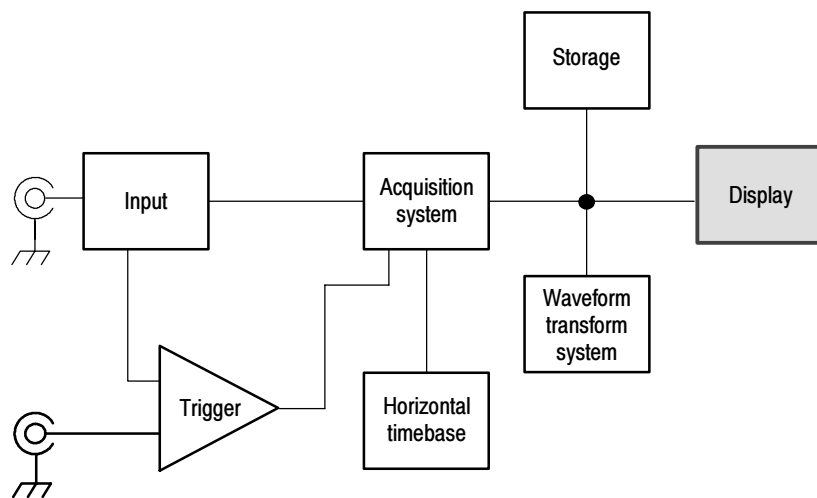

Using the Waveform Display

The waveform shown below is displayed as part of the User Interface (UI) application. The UI application takes up the entire screen of the oscilloscope and the graticule takes up most of the UI application. Some terms that are useful in discussing the display follow.

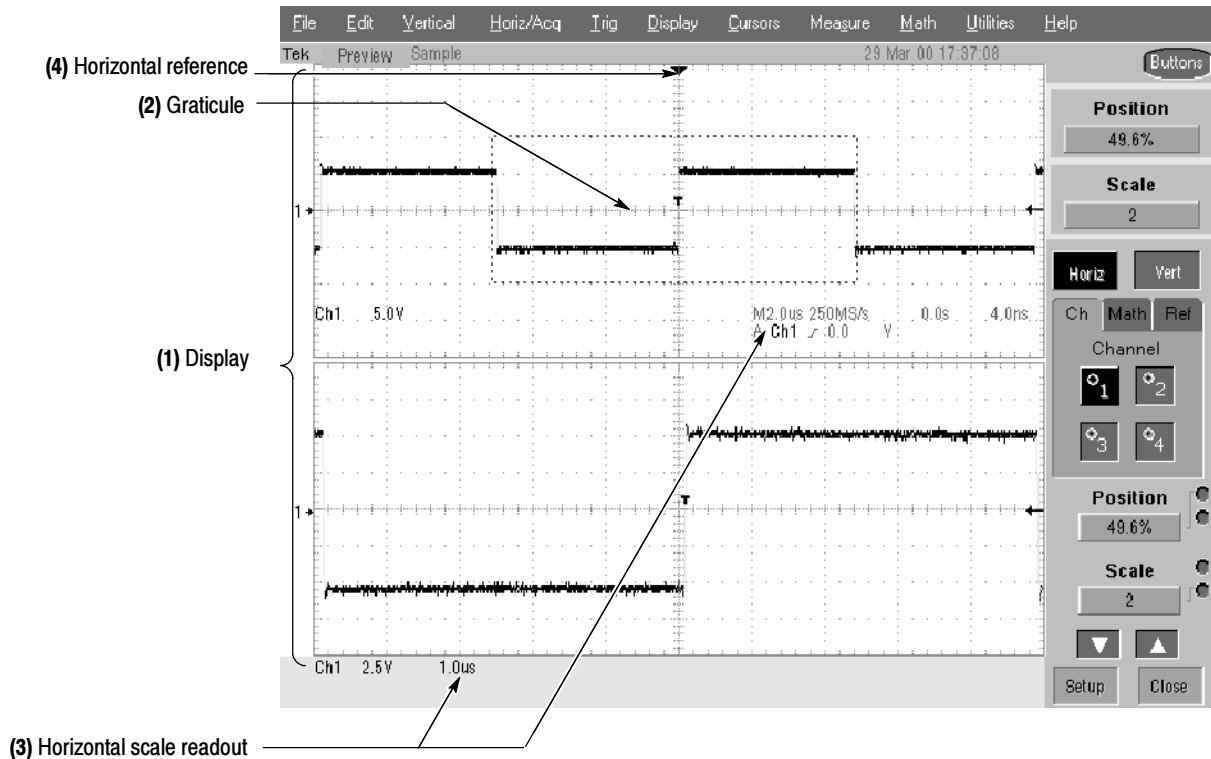

Figure 3-28: Display elements

(1) Display area: the area where the waveforms appear. The display comprises the timebase and graticules, the waveforms, histograms, and some readouts.

(2) Graticule: a grid marking the display area. When Zoom is on, the upper graticule displays unmagnified waveforms and the lower graticule displays magnified waveforms.

(3) Horizontal-scale readout: for magnified and unmagnified waveforms.

(4) Horizontal reference: a control that you can position to set the point around which channel waveforms expand and contract horizontally on screen as you change the Horizontal Scale control or push the ZOOM button. The reference is also the trigger point when the horizontal delay is 0%.

Touch Screen (not shown): a feature that lets you touch on-screen controls or touch and drag screen objects to operate the oscilloscope.

Some features of the display follow.

Flexible Display Control: Front-panel knobs and buttons support quick access to the most often used adjustments — those that display, position, and scale waveforms. Mouse, keyboard, and touchscreen interfaces support complete setup of all the display parameters. Anything you can do with the mouse, you can do with the touch screen.

Fast Access to Zoom: Waveform inspection has never been easier. Just touch and drag a box around the feature of interest and select zoom from the choices offered, and the feature of interest displays zoomed in the magnified graticule.

Acquisition Preview: When the next acquisition is delayed due to slow triggers or long acquisition duration, acquisition preview attempts to show what the next acquisition will look like. Acquisition preview does not re-calculate math waveforms or represent changes in trigger levels, trigger modes, or different acquisition modes. Acquisition preview waveforms can't be saved as data.

Using the Display

Read the following topics; they provide the details that can help you set up the oscilloscope display so that it best supports your data-analysis tasks.

Waveform Display. In general, the method of displaying a waveform is to *define the waveform, if necessary (math and reference waveforms), and then turn it on*. Table 3-6 summarizes this process as it applies to the different waveforms.

Table 3-6: Defining and displaying waveforms

Waveform	To define:	To turn on:
Channel: Ch1 - Ch4	Channels are predefined	Push the Vertical CH button to toggle the channel on or off.
Reference: Ref1 - Ref4	<p>Define an active reference waveform by:</p> <ul style="list-style-type: none"> ■ Saving a channel, reference, or math waveform to one of locations Ref1 - Ref4. ■ Recalling a waveform previously saved to a file into one of locations Ref1 - Ref4. <p>Both of these operations can be performed from the File menu.</p>	From the Refs setup control window, touch Display to toggle display of the selected reference on or off.
Math: Math1 - Math4	<p>Define a math waveform by creating a math waveform using existing sources (channel, math, and reference waveforms, and measurements).</p> <p>This operation can be performed by touching the Math button and then selecting Define/Edit Expression.</p>	When defining a math waveform, you turn it on in the Math setup control window.

Operations on Waveforms. In general, the method of adjusting (vertically scaling, offsetting, positioning, and so on) is from the front panel: adjust a waveform using its Vertical Scale and Position knobs.

Table 3-7 summarizes operations you can perform for the three waveform types.

Table 3-7: Operations performed based on the waveform type

Control function	Waveform supports			Operating notes
	Ch	Ref	Math	
Vertical Scale	Yes	Yes	Yes	Math and reference waveforms are scaled and positioned from their setup control windows.
Vertical Position	Yes	Yes	Yes	
Vertical Offset	Yes	No	No	
Horizontal Scale	Yes	Yes	Yes	Waveforms are adjusted according to the Zoom Lock setting.
Horizontal Position	Yes	Yes	Yes	
Horizontal Record Length	Yes	No	No	
Quick Horizontal and Vertical Scale Adjust (Zoom)	Yes	Yes	Yes	Dragging a box around a portion of the selected waveform adjusts horizontal scale to fill the zoom graticule with the boxed portion (see <i>Setting Zoom Controls</i> on page 3-109).

Graticules. Touch a Graticule Size button in the Zoom Setup window to change the size of the acquisition waveform and zoomed waveform windows. The 50-50 button allocates half of the available display for the zoomed graticule and half of the available display for the acquisition window. The 80-20 button allocates 80% of the available display for the zoomed graticule and 20% for the acquisition window. Touch 100 to use the entire display for the zoomed graticule.

Figure 3-28 on page 3-102 shows the elements of the graticules; the elements are the same for each graticule displayed.

Operations on the Timebase. In general, the method of adjusting (horizontally scaling, setting resolution/record length, positioning, etc.) is from the front panel: *adjust the timebase using the Horizontal Scale, Resolution, and Position knobs*. Only channel waveforms can be set directly:

Table 3-7 shows how horizontal operations relate to the waveform types; the key points to remember follow:

- The oscilloscope displays a reference waveform with horizontal settings in effect at the time it was saved. You cannot adjust these settings. See *Saving and Recalling Waveforms* on page 3-213 for more information on reference waveforms.
- The oscilloscope displays a math waveform with the horizontal settings derived from the math expression that creates it. You cannot change these directly. See *Creating and Using Math Waveforms* on page 3-153 for more information on math waveforms.
- All waveforms are displayed fit-to-screen; that is, within the horizontal divisions that the graticule provides. However, some waveforms may be wider or narrower than the full graticule due to acquisition rate/time scale combinations and acquisition preview.

Display and Acquisition Controls. For channel waveforms, the vertical and horizontal controls you set also adjust the oscilloscope acquisition parameters. See the following descriptions for more information:

- *Vertical Acquisition Window Considerations* on page 3-14
- *Horizontal Acquisition Window Considerations* on page 3-18

Horizontal Position and the Horizontal Reference. The time values you set for horizontal position are from the trigger point to the horizontal reference point. This is not the time from the trigger point to the start of the waveform record unless you set the horizontal reference to 0%. See Figure 3-29.

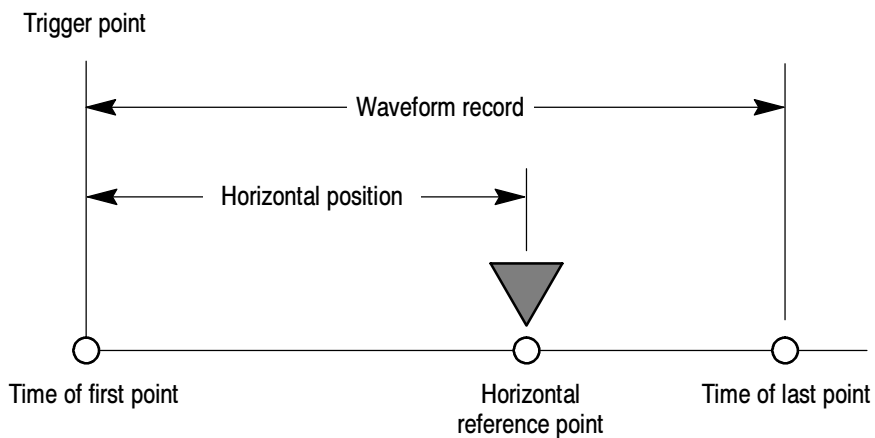

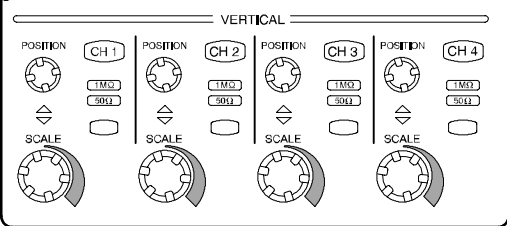
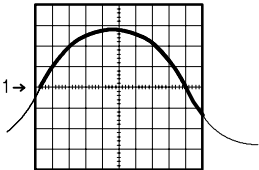
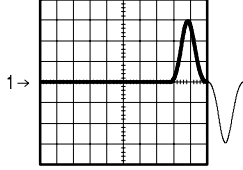
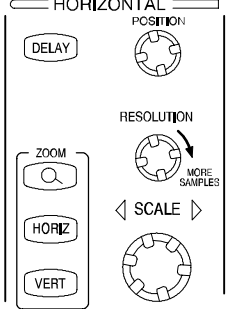



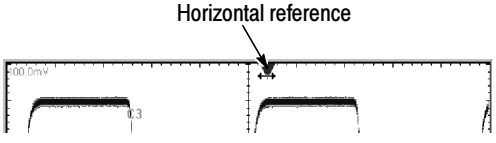
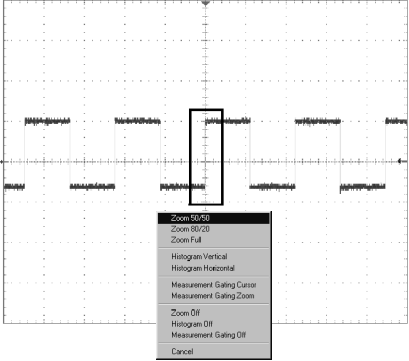

Figure 3-29: Horizontal Position includes time to Horizontal Reference

Mouse and Touch Screen Operation. In general, anything you can do with the mouse, you can do by touching the screen, if the touch screen is on. You can select or change all menus and buttons that are displayed on screen by mouse clicks or touching the on-screen control while the touch screen is on.

To Display Waveforms in the Main Graticule

Use the procedure that follows to become familiar with the display adjustments you can make.

Overview	To display waveforms in the main graticule	Related control elements & resources
<p>Prerequisites</p>	<ol style="list-style-type: none"> 1. The oscilloscope must be installed and operating. 2. The acquisition system should be set to run continuously. 	 <p>See page 3-27 for acquisition setup and page 3-53 for trigger setup.</p>
<p>Set vertical display parameters</p>	<ol style="list-style-type: none"> 3. Push a channel button to select the waveform (it displays). A channel button lights when its channel is on. <p>Hint. For information on math waveforms, see <i>To Define a Math Waveform</i> on page 3-160. For information on reference waveforms, see <i>Saving and Recalling Waveforms</i> on page 3-213.</p> <ol style="list-style-type: none"> 4. Use the Vertical knobs to achieve a good display of each waveform you select. 	
<p>Set horizontal display parameters</p>	<ol style="list-style-type: none"> 5. To make sure the main graticule is selected, push the Zoom button to toggle it off. Use the horizontal knobs to scale and position the waveform on screen and to set sample resolution. <div style="display: flex; justify-content: space-around;"> <div style="text-align: center;"> <p>Scaled Horizontally</p>  </div> <div style="text-align: center;"> <p>Positioned Horizontally</p>  </div> </div> <p>The Sample Density knob sets the record length. (See discussion on page 3-19.)</p> <p>Push PUSH TO SET TO 50% if required to stabilize display.</p>	 <p style="text-align: center;">LEVEL PUSH TO SET 50%</p> 

Overview	To display waveforms in the main graticule (Cont.)	Related control elements & resources
<p>Adjust the horizontal reference</p>	<p>6. To adjust the point around which the waveforms expand and contract, touch the Horizontal Reference and drag it left or right on screen.</p> <p>Move the Horizontal Reference along the horizontal axis until it aligns to the point on the waveform you want to be stationary on screen.</p> <p>Note: if Delay is off, Horizontal Reference is the same as Horizontal Position.</p> <p>7. Release the Horizontal Reference, and then adjust the Horizontal Scale.</p>	
<p>Quick-adjust the timebase (zoom)</p>	<p>8. To quickly rescale a portion of a channel waveform so it expands to fill the 10 divisions on screen, touch and drag across the segment of the waveform that you want to see in greater detail. Then select Zoom 50/50%, Zoom 80/20%, or Zoom 100% from the drop-down list to magnify the highlighted waveform segment.</p> <p>Note. The oscilloscope displays the box-enclosed area on the waveform magnified in the graticule.</p>	
<p>Explore the zoom controls</p>	<p>9. The next procedure deals with setting up and controlling Zoom.</p>	 <p>See Setting Zoom Controls on page 3-109.</p>

Setting Zoom Controls

The oscilloscope can expand or compress (zoom in or out) on a waveform without changing the acquisition parameters (sample rate, record length, and so on). This section describes how to use Zoom and how it interacts with the selected waveform.

Use Zoom (push the ZOOM button) when you want to expand a waveform to inspect small feature(s) on that waveform or compare the feature to the non-zoomed waveform(s). For example, to temporarily expand the front corner of a pulse to inspect its aberrations, use Zoom to expand it horizontally and vertically.

Using with Waveforms

To help you use zoom effectively, consider how it operates on waveforms. When in zoom mode, the oscilloscope vertically expands or contracts one waveform at a time. Also, the oscilloscope only vertically positions one waveform at a time when in Zoom.



When zooming horizontally, Zoom expands either the waveform you select, all live waveforms, or all live and reference waveforms, depending on the setting for Horizontal Lock in the Zoom menu.





When zooming horizontally or vertically, Zoom expands or contracts the waveform by the zoom scale factor.

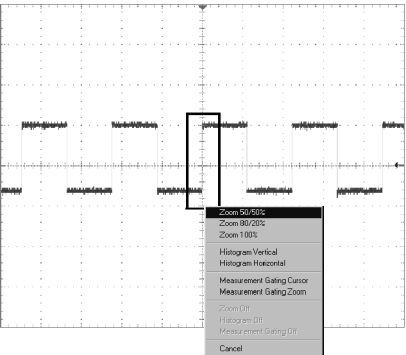

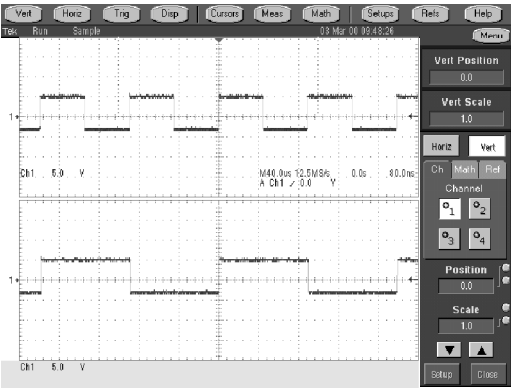
To Zoom Waveforms

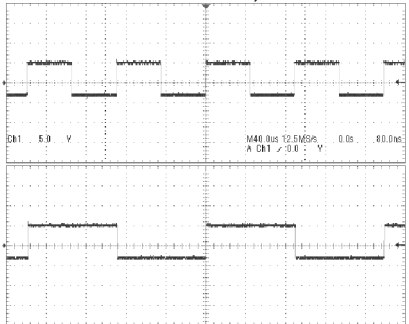

Use the procedure that follows to zoom a waveform. For more information, display online help when performing the procedure.

Overview	To zoom waveforms	Control elements & resources
<p>Prerequisites</p>	<p>1. The oscilloscope must be installed and operating. Oscilloscope must be powered up, with horizontal and vertical controls and triggering set up.</p>	<div data-bbox="1170 1352 1269 1461" data-label="Image"> </div> <p data-bbox="1097 1486 1377 1514">See page 3-53 for trigger setup.</p>

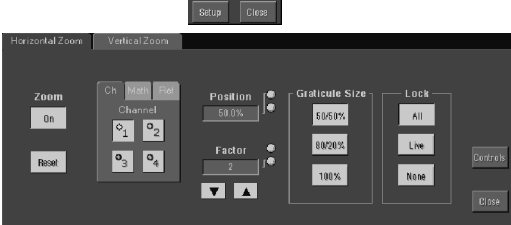
Overview	To zoom waveforms	Control elements & resources
<p>Select zoom</p>	<p>2. You can select zoom in two ways:</p> <ul style="list-style-type: none"> ■ To zoom a waveform, touch and drag across the segment of the waveform that you want to see in greater detail. Then select Zoom 50/50%, Zoom 80/20%, or Zoom 100% from the drop-down list to magnify the highlighted waveform segment. ■ Zoom 50/50% creates two half-height graticules and displays the magnified waveform(s) in the lower graticule, and the unmagnified waveform(s) in the upper graticule ■ Zoom 80/20% creates two graticules and displays the magnified waveform(s) in the larger lower graticule, and the unmagnified waveform(s) in the upper graticule ■ Zoom 100% displays the magnified waveform(s) in a single graticule <p>Note. The oscilloscope displays the box-enclosed area on the waveform magnified in the graticule. If two graticules are shown, the magnified waveform is shown in the bottom graticule.</p> <ul style="list-style-type: none"> ■ Push the ZOOM button to split the screen and add a zoom graticule. <p>If the oscilloscope creates two graticules, the magnified waveform(s) is displayed in the lower graticule, and the unmagnified waveform(s) in the upper graticule. Use the Zoom Setup menu to change the graticule size.</p>	  

Overview	To zoom waveforms	Control elements & resources
<p>Zoom a waveform</p>	<p>3. To zoom a waveform, start by using one of two methods to select the axis that you want to adjust:</p> <ul style="list-style-type: none"> ■ Push the HORIZ button or the VERT button to select the axis that you want to adjust in the zoom graticule. ■ Touch the HORIZ button or the VERT button in the control window to select which axis is controlled by the multipurpose knobs. <p>4. Use the multipurpose knobs to adjust zoom factor and position of the magnified waveform.</p> <p><i>Note.</i> As you change the zoom factor or move the unmagnified waveform relative to the box, the oscilloscope alters the magnified display accordingly to include only the waveform portion within the box.</p> <p>As you change the zoom factor or move the magnified waveform, the oscilloscope scales or moves the box relative to the unmagnified waveform, so that the box encloses only the magnified portion of the waveform.</p> <p>5. To select the waveform that you want to change, select the channel (Ch), Math, or reference (Ref) tab, and then select the channel, math, or reference number for the waveform that you want to change, or touch its level-marker with the mouse or touch screen.</p>	   <p>Nonzoomed waveforms, with box</p>  <p>Zoomed (magnified) waveforms</p> 

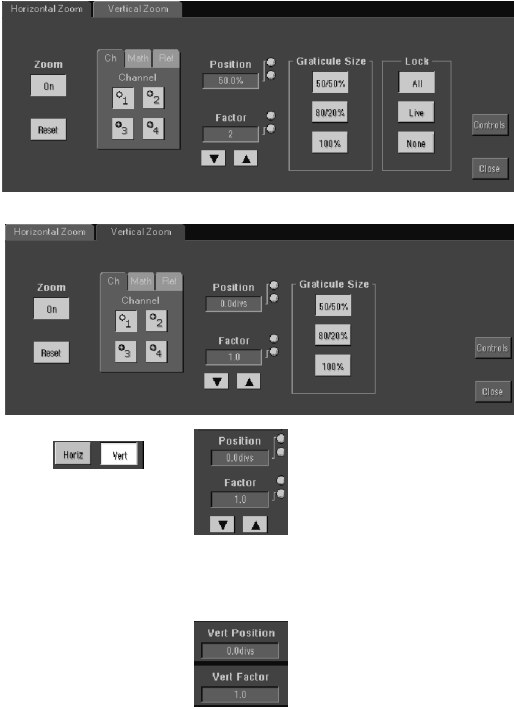
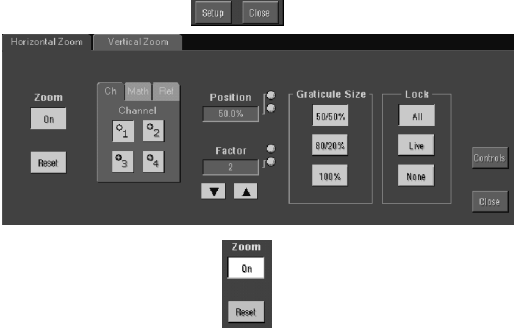
Overview	To zoom waveforms	Control elements & resources
<p>Set up zoom</p>	<p>6. To display the Zoom setup window, touch Setup in the controls window.</p> <p><i>Note: To reduce the Zoom setup window to the controls window, touch Controls.</i></p> <p>7. Touch a Graticule Split button to change the size of the unmagnified (Acquisition) and Zoom windows:</p> <ul style="list-style-type: none"> ■ 50-50 allocates half of the available display for the zoomed graticule and half of the available display for the acquisition window. ■ 80-20 allocates 80% of the available display for the zoomed graticule and 20% for the acquisition window. ■ 100 uses the entire display for the zoomed graticule. <p>8. Depending on the selection for Zoom Lock, Zoom affects the selected waveform, live waveforms, or all live, math, and reference waveforms. To set which controls the horizontal zoom controls affect, touch Zoom Lock All, Live, or None.</p> <p><i>None</i> — the selected waveform in the zoomed graticule is individually adjusted.</p> <p><i>Live</i> — all channels and “live” math waveforms in the zoomed graticule are adjusted and horizontally positioned at the same time.</p> <p><i>All</i> — all waveforms are adjusted at the same time.</p>	 <p>The screenshot shows the 'Zoom Setup' window with the following controls:</p> <ul style="list-style-type: none"> Zoom: On, Off, Reset buttons. Channel: Ch, Math, Ref buttons. Position: 50.0% value with up/down arrows. Graticule Size: 50/50%, 80/20%, 100% options. Lock: All, Live, None buttons. Buttons: Setup, Close, Controls, Close.  <p>The 'Zoom Lock' dialog box shows three options: All, Live, and None.</p>

Overview	To zoom waveforms	Control elements & resources
<p>Checking the zoom scale and position</p>	<p>9. To quickly determine the zoom scale and position of a zoomed waveform, check the readouts:</p> <ul style="list-style-type: none"> ■ The Horizontal Zoom setup window displays the horizontal position and zoom factor of the (Zoom) window. ■ The Vertical Zoom setup window displays the vertical position and zoom factor of the (Zoom) window. ■ From the Zoom control window, touch Vert or Horiz to display the vertical or horizontal zoom factor and position in the control window. ■ From the Zoom control window, touch Position or Factor and use the multipurpose knobs to change the zoom position and factor. The knob readout also displays the zoom position and factor. 	
<p>Reset zoom</p>	<p>10. To reset all Horizontal zoom factors to their defaults, from the Zoom control window, touch Setup, and select the Horizontal Zoom tab.</p> <p>11. Touch Reset to reset the Horizontal zoom factor and position.</p>	
<p>For further assistance</p>	<p>1. Click the Help button while in the Zoom setup window to access a context-sensitive overview of the Zoom controls and their set up.</p>	 <p>See <i>Accessing Online Help</i> on page 3-245 for overview of the online help system.</p>

Customizing the Display

Use the display customizing features this oscilloscope provides to present the display elements — color, graticule style, waveform representation, and so on — according to your preferences.

From the Color Palette, you can select temperature, spectral, or gray scale color grading of a waveform so that its data color or intensity reflects the sample density of the data in that area of the waveform.

Using Display Controls

Read the following topics; they provide the details that can help you set up the the display system so that it displays waveforms and other display elements as you prefer.

Display Settings. Table 3-8 lists display attributes that you can set and where they are accessed.

Table 3-8: Customizable display elements

Display attribute	Access		Options
	Menu name ¹	Entry	
Graticule Style	Display	Graticule Style	Choose from: Full, Grid, Cross-hair, and Frame styles.
	Disp	Objects	
Display Mode	Display	Display Persistence	Choose from Off, Infinite Persistence, and Variable Persistence Modes.
	Disp	Appearance	
Display Style	Display	Display Style	Choose Dots to display each waveform as a series of dots. Choose Vectors to display vectors or lines between the dots.
	Disp	Appearance	Choose Intensified Samples to display actual samples as bright dots; interpolated dots are dimmed.
Screen Text	Display	Screen Text	Enter text that you can display and position on screen. Also see <i>Label The Waveform</i> on page 3-215
	Disp	Screen Text	

Table 3-8: Customizable display elements (Cont.)

Display attribute	Access		Options
	Menu name ¹	Entry	
Color Palette (Graticule and Waveform)	Display	Colors	Choose Normal to use system colors for best viewing. Choose Green to display variable persistence waveforms in shades of green. Choose Gray to display variable persistence waveforms in shades of gray. Choose Temp (temperature) to display variable persistence waveforms with the highest sample density points appearing in warmer colors (reds).
	Disp	Colors	Choose Spectral to display variable persistence waveforms with the highest sample density points appearing in blue shades. Choose User to use custom palette colors for the selected source. Choose User Palette Edit. . . to display the window in which you can set custom hue, lightness, and saturation for the selected source.
Reference Colors	Display	Colors	Choose Default to use the default system color (white) for reference waveforms.
	Disp	Colors	Choose Inherit to use the same color for the reference waveform as the original waveform.
Math Colors	Display	Colors	Choose Default to use the default system color (red) for math waveforms.
	Disp	Colors	Choose Inherit to use the same color for the math waveform as the waveform the math function is based on.
Waveform Interpolation	Display	Appearance	Choose from Sin(x)/x or Linear interpolation.
	Disp	Appearance	
Waveform Intensity	Display	Appearance	Toggle AutoBright On to set the brightness maximum to the value of the most frequent event. Toggle AutoBright Off to let the brightness depend on the trigger rate, creating a display like an analog oscilloscope.
	Disp	Appearance	Touch Record View or FastAcq/WfmDB, and use the keypad or multipurpose knobs to adjust the intensity of waveforms.
Display format	Display	Appearance	Choose YT, XY, or XYZ display formats. For additional information see <i>To Set Display Format</i> on page 3-45.
	Disp	Appearance	
Trigger Level Marker	Disp	Objects	Choose a Short level marker at the right side of the graticule, a Long level marker the width of the graticule, or Off for no trigger level marker.
Trigger T	Display	Display Trigger T	Toggle on and off the display of a T at the trigger point.
	Disp	Objects	

Table 3-8: Customizable display elements (Cont.)

Display attribute	Menu name ¹	Access Entry	Options
LCD Backlight Timeout	Display	Backlight Timeout Enabled	Toggle the backlight timeout on and set the delay time before it becomes active. When on, the back light and LCD (liquid crystal display) turn off and the Windows screen saver will not display. When off the Windows screen saver will display if it is enabled.
	Disp	Objects	
Date and Time	Display	Display Date and Time	Toggle on and off the display of the system date and time.
	Disp	Objects	
Set Date and Time	Utilities	Set Date and Time	Set the date and time using the Set Time and Date setup window that is displayed.

¹ The Menu Names refer to the menus found in the menu bar or tool bar at the top of the oscilloscope screen.

Normal and Persistence Displays. Use the display persistence to control how waveform data ages:

- *Off* style displays waveforms without persistence: each new waveform record replaces the previously acquired record for a channel. You can choose to display normal waveforms as vectors, which displays lines between the record points or dots (vectors off) which displays the record points only. You can also choose an interpolation mode. See *Interpolation* below.
- *Variable Persistence* style accumulates the waveform-record points on screen and displays them only for a specific time interval. Previous waveform data continuously fades from the display as new waveform records acquire.
- *Infinite Persistence* style accumulates the data record points until you change some control (such as scale factor) causing the display to be erased. Waveform data builds up as new data records acquire.

Persistence style is only available for live waveforms (waveforms with data that is being updated); reference waveforms are static and do not use persistence. Math waveforms use persistence if their sources are live waveforms.



Interpolation. When, due to preview or zoom, the available sample density falls to less than 1 sample per display column, the oscilloscope calculates intermediate points by either the linear or sine algorithms, and uses them to produce points. There are two options for interpolation:



- *Sin(x)/x interpolation* computes record points using a curve-fit between the actual values acquired. The curve-fit assumes all the interpolated points fall along that curve. Sin(x)/x interpolation is particularly useful when acquiring more rounded waveforms such as sine waves. It is also appropriate for general use, although it may introduce some overshoot or undershoot in signals with fast rise times.
- *Linear interpolation* computes record points between actual acquired samples by using a straight-line-fit. The straight-line-fit assumes all the interpolated points fall in their appropriate point in time on that straight line. Linear interpolation is useful for many waveforms such as pulse trains.

Interpolation is used whenever the displayed sample density falls below 1 sample per column. If the acquired record length is 500 points, zoom of 2x requires interpolation. If instead, the record length of the acquisition is 100K, horizontal zoom of 200x produces 1 sample per column ($100,000/500 = 200$); therefore, you will see interpolated samples starting at the next scale setting.

Set Display Styles

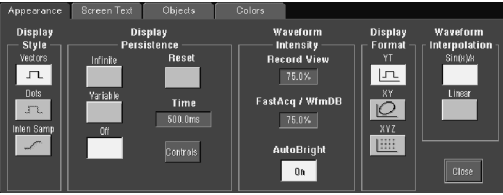
Use the procedure that follows to become familiar with the display adjustments you can make.

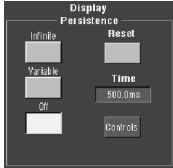
Overview	Set display styles	Related control elements & resources
<p>Prerequisites</p>	<p>1. The oscilloscope must be powered up, with any waveform you want to display on screen.</p>	<div style="text-align: center;">  <p>See page 3-27 for acquisition setup & page 3-53 for trigger setup.</p> </div>
<p>Access the display setup dialog box</p>	<p>2. From the tool bar, touch Disp, and then select the Appearance tab. See right.</p>	<div style="text-align: center;">  </div> 

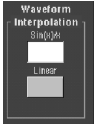
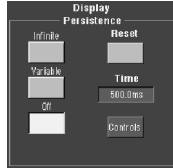

Overview	Set display styles	Related control elements & resources
<p>Select the display style and persistence and waveform interpolation mode</p>	<p>3. From the Display Persistence group, choose Off to select a display with no acquisition data persistence.</p> <p>Off displays Waveforms with new data replacing the data from previous waveform acquisitions.</p> <p>Infinite persistence continuously accumulates record points until you change an acquisition setting.</p> <p>Variable persistence accumulates record points for a specified time. Each point decays in a set time interval.</p> <p>4. From Display Style, select an available style:</p> <p>Vectors displays lines between waveform dots.</p> <p>Dots displays waveform record points as dots.</p> <p>Inten Samp displays actual samples as bright dots and blacks out interpolated samples.</p> <p><i>Note: adjustment of display intensity may be necessary to set display intensity to the desired level.</i></p> <p>5. Select an Interpolation mode by choosing Sin(x)/x or Linear. For more information see <i>Interpolation</i> on page 3-117.</p>	  
<p>Select a persistence mode</p>	<p>6. From the the Display setup control window (see right), choose:</p> <ul style="list-style-type: none"> ■ Infinite Persistence to make data persist indefinitely. Waveform displays accumulate data as new waveform records acquire, resulting in a build up of data in the displayed waveforms. ■ Variable Persistence to make data persist momentarily, but also decay. New waveform displays accumulate data as new waveform records acquire, but with continuous replacement of the oldest data. <p>If you select Variable Persistence, set a time at which the oldest data fades away.</p> <ul style="list-style-type: none"> ■ Off to make data display for the current acquisition only. ■ Reset to restart the accumulation of data. 	

Overview	Set display styles	Related control elements & resources
<p>Continue with next procedure</p>	<p>7. For more ways to customize the display, follow up with the next procedure.</p>	<div data-bbox="1175 365 1276 478" data-label="Image"> </div> <p>See <i>Customize Graticule & Waveforms</i> on page 3-119.</p>

Customize Graticule & Waveforms

Use the procedure that follows to become familiar with the display adjustments that you can make.

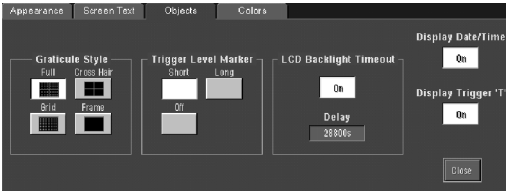
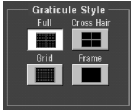
Overview	Customizations you can make	Related control elements & resources
<p>Prerequisites</p>	<p>1. Display the waveforms to be measured on screen. The waveform may be a channel, reference, or math waveform.</p>	<div data-bbox="1166 814 1266 928" data-label="Image"> </div> <p>See page 3-27 for acquisition setup & page 3-53 for trigger setup.</p>
<p>Change waveform color</p>	<p>2. From the Display setup control window, select the Colors tab.</p> <p>3. Choose a color palette from the Color Palette list.</p> <p>Normal, Green, and Gray give the appearance of an intensity-graded display similar to an analog oscilloscope.</p> <p>Spectral and Temp use hue to indicate the frequency of occurrence and to highlight events.</p> <p>User and User Palette let you create a custom color palette.</p>	<div data-bbox="987 1073 1507 1264" data-label="Image"> </div> <div data-bbox="1075 1289 1367 1472" data-label="Image"> </div>

Overview	Customizations you can make (Cont.)	Related control elements & resources
<p>Change graticule style</p>	<ol style="list-style-type: none"> From the Display setup control window, select the Objects tab. See right. Touch the Full, Grid, Cross Hair, or Frame button to select that style of graticule. 	 
<p>For further assistance</p>	<ol style="list-style-type: none"> Click the Help button in the tool bar to access a context-sensitive overview of the display controls and their set up. 	 <p>See <i>Accessing Online Help</i> on page 3-245 for overview of the online help system.</p>

Measuring Waveforms

The oscilloscope comes equipped with cursors and automatic measurements to assist you in analyzing your waveforms. This section describes these tools and how you use them:

- *Taking Automatic Measurements*, on page 3-122, describes how you can setup the oscilloscope to automatically measure and display a variety of waveform parameters. See Figure 3-30.
- *Taking Cursor Measurements*, on page 3-132, describes using cursors to make measurements on waveforms. See Figure 3-30.
- *Taking Histograms*, on page 3-138, describes how to take histograms to view the horizontal or vertical distribution of data on your waveforms.
- *Optimizing Measurement Accuracy*, on page 3-141, tells you how to run compensation routines and how to deskew channels to optimize the accuracy of your measurements.

NOTE. *You can also make graticule measurements, counting graticule divisions and multiplying them by the vertical or horizontal scales set for the waveform you are measuring.*

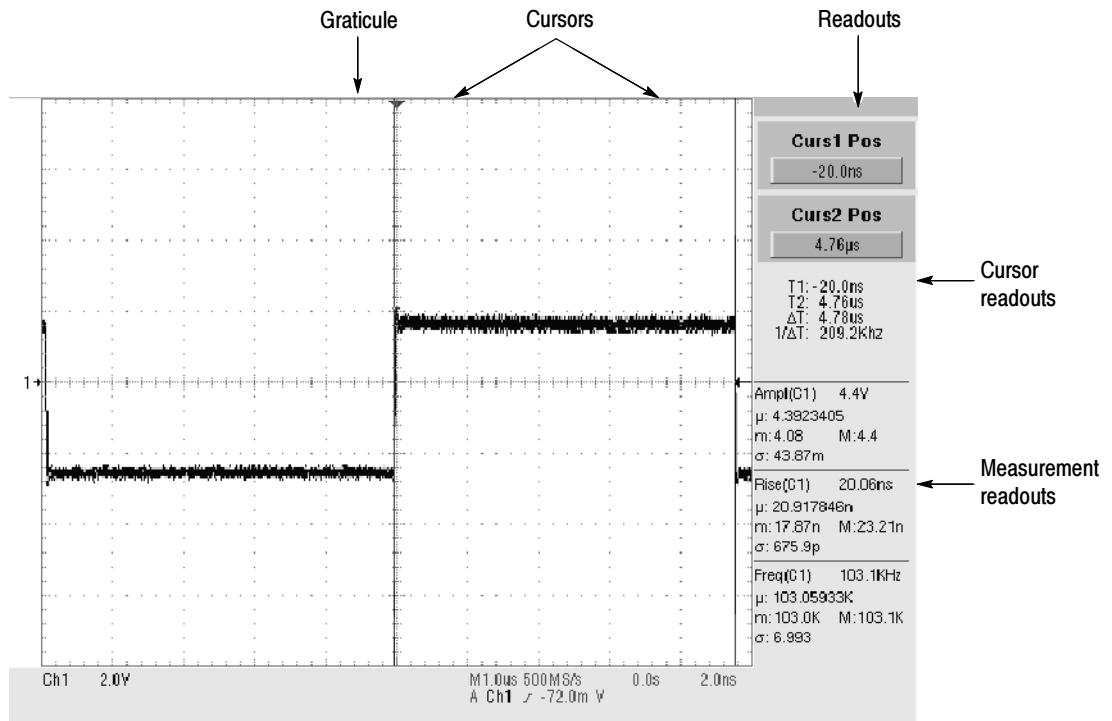

Figure 3-30: Graticule, Cursor, and Automatic measurements

Taking Automatic Measurements

The oscilloscope automatically takes and displays waveform measurements. This section describes how to set up the oscilloscope to let it do the work of taking measurements for you.

Because automatic measurements use the waveform record points, and in Fast Acquisitions mode measurements use a two dimensional array of points, automatic measurements are usually more accurate than cursor and graticule measurements. And the oscilloscope does the work, continuously taking, updating, and displaying these measurements.

Some features of automatic measurements follow.

Annotate Waveforms On Screen. You can create text to mark characterization levels that each measurement uses to compute results. See Customizing the Display on page 3-114 additional information.

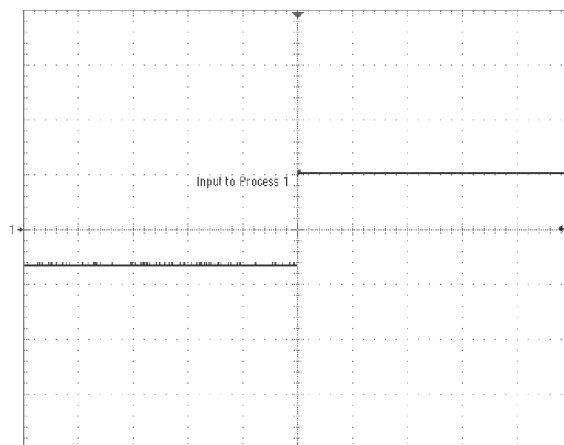

Figure 3-31: Annotated display

Customize Measurements. To allow you control over how your waveform data is characterized by measurements, the oscilloscope lets you set the methods used for measurement. See *High/Low Method* on page 3-124 and *Reference Levels Method* on page 3-125.

See Statistics on Measurement Results. To see how automatic measurements vary statistically, you can display a readout of the Min, Max, Mean, and Standard Deviation of the measurement results. See page 3-128 for more information.

Select Measurement Parameters. You can select from an extensive range of parameters to measure; for a list, see *Appendix B: Automatic Measurements Supported*.

Measure Part of a Waveform. You can feed the entire waveform to a measurement or limit the measurement to a segment of the waveform. By default, the oscilloscope takes each automatic measurement over the entire waveform record, but you can use measurement gates and zoom to localize each measurement to a section of a waveform (see *To Localize a Measurement* on page 3-130).

Select Measurement Sources. Select from these measurement sources: channel, Reference, and math waveforms.

Take Measurements on a Frame. In FastFrame, measurements are taken only on the displayed frame.

Using Automatic Measurements

Read the following topics; they provide the details that can help you set up automatic measurements so that they best support your data-analysis tasks.

Measurement Selection. The oscilloscope takes automatic measurements of the following categories: Amplitude, Timing, More, and Histogram. Check *Appendix B: Automatic Measurements Supported* for a listing of the measurements that you can choose from in each category.

Number of Measurements. The oscilloscope can take and update up to eight measurements at one time. You can apply measurements to any combination of sources (described below). You can take all eight measurements on Ch1 for example or you can take measurements on Ch1 - Ch4, Math1 - Math4, Ref1 - Ref4, or a histogram.

Measurement Sources. All channel, reference, and math waveforms can serve as sources for automatic measurements.

Some measurements, such as delay and phase, require two sources. For example, delay would be used to measure an input from one measurement source (for example, C1) with respect to an output in another source (C2).

High/Low Method. The levels that the automatic measurement system derives as the High (Top) or Low (Bottom) for a waveform influence the fidelity of amplitude and aberration measurements. You can select among the modes the oscilloscope provides for determining these levels:

- *Histogram* sets the values statistically. It selects the most common value either above or below the midpoint (depending on whether it is defining the high or low reference level). Since this statistical approach ignores short term aberrations (overshoot, ringing, etc.), Histogram is the best setting for examining pulses. See Figure 3-32.

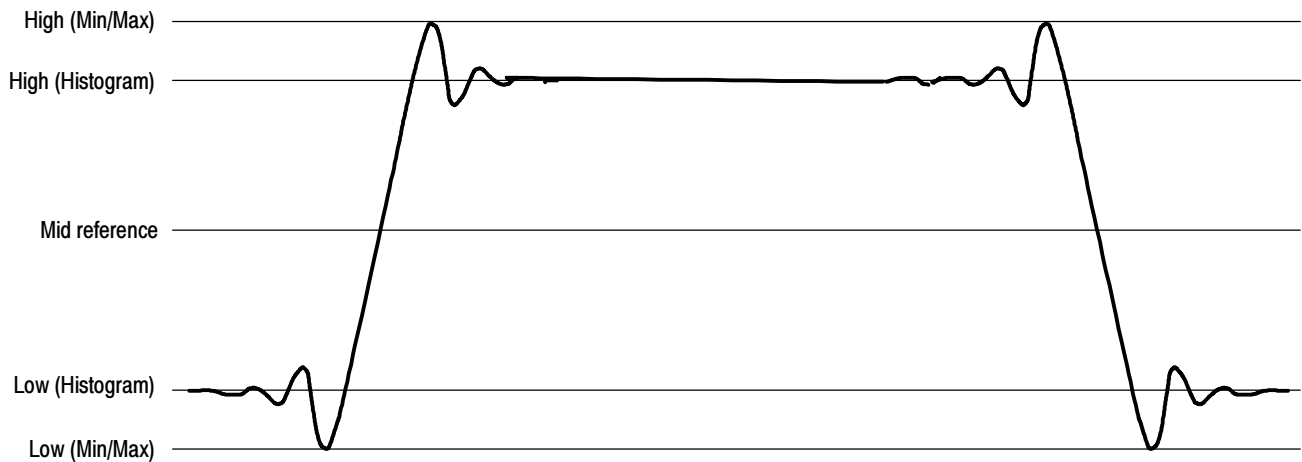

Figure 3-32: High/Low tracking methods

- *Min-max* uses the highest and lowest values of the waveform record. This setting is best for examining waveforms that have no large, flat portions at a common value, such as sine waves and triangle waves — almost any waveform except for pulses. See Figure 3-32.

Reference Levels Method. A second set of levels affect the fidelity of time-related measurements, the Hi, Mid, and Lo references. For example, the measurement system takes risetime measurements from the waveform-edge that transitions from the Low to High reference levels.

The oscilloscope provides the following calculation methods; refer to Figure 3-33 as you read about each method:

1. *Relative Reference* is calculated as a percentage of the High/Low range.
2. *Absolute Reference* is set by absolute values in user units.

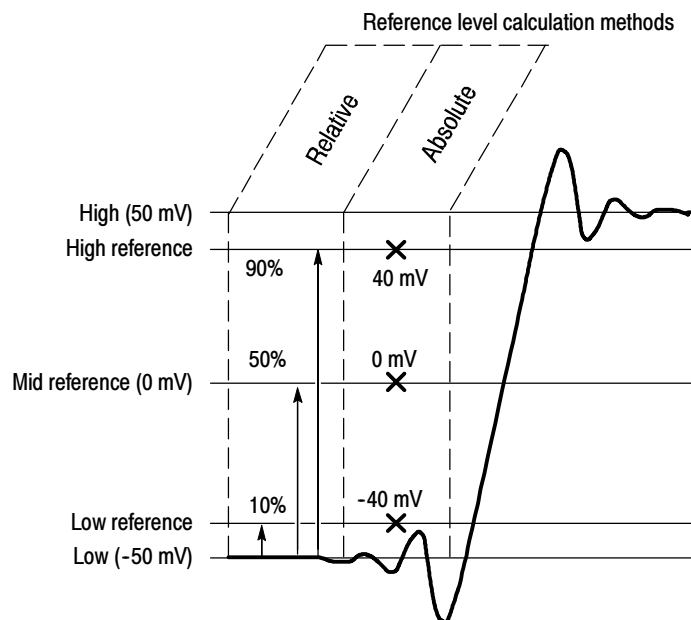



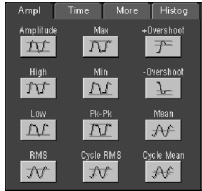
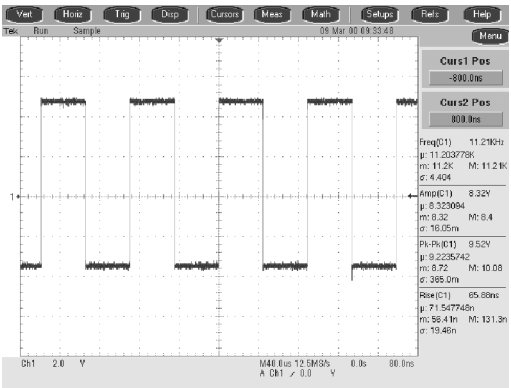

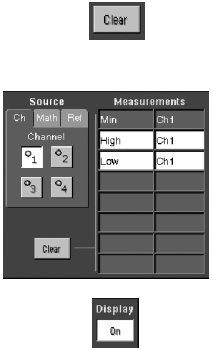

Figure 3-33: Reference-level calculation methods





The High and Low levels from which the reference levels are calculated are the levels established using the selected Hi/Low method described on page 3-124.



To Take Automatic Measurements

Use the procedure that follows to quickly take a measurement based on the default settings for High/Low and for reference-levels.

Overview	To take automatic measurements	Related control elements & resources
<p>Prerequisites</p>	<p>1. Obtain a stable display of the waveform to be measured.</p>	 <p>See page 3-27 for acquisition setup & page 3-53 for trigger setup.</p>
<p>Select the waveform</p>	<p>2. From the tool bar touch Meas to display the Measurement setup control window.</p> <p>3. To select the source waveform you want to measure, select the Ch, Math, or Ref Source tab, and then touch the Channel, Math, or Reference button for the waveform you want to measure.</p> <p>The waveform may be a channel, reference, or math waveform.</p>	 
<p>Take automatic measurements</p>	<p>4. From the Measurement setup control window, select the Ampl, Time, More, or Histog tab that contains the measurement you want to take.</p> <p>5. Touch the button for the measurement you want to take. For a list of the measurements this oscilloscope can take, see Appendix B: Automatic Measurements Supported.</p> <p>The readout for the measurement is automatically displayed, and the measurement is added to the measurement list in the control window.</p> <p>Measurements are displayed in the right control window area as show here. If the window is occupied or there are too many measurements to fit in that area, measurements are displayed in the lower graticule area.</p> <p>In Roll mode measurements are not available until after you stop acquisitions.</p>	 

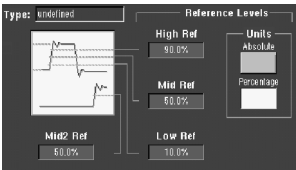

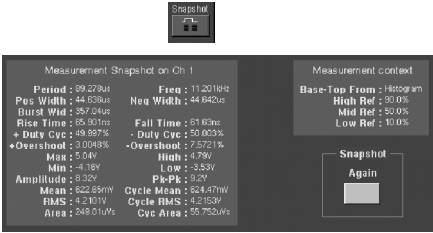
Overview	To take automatic measurements	Related control elements & resources
<p>Remove measurements</p>	<p>6. To remove the measurement touch Clear and the last measurement selected is removed.</p> <p>7. To remove any measurement in the measurement list touch the measurement prior to touching the Clear button. More than one measurement can be selected by touching the first measurement to remove and then dragging across all measurements you wish to select and then touching the Clear button.</p> <p>8. You can also toggle the display of measurements on and off by touching the Display button.</p>	
<p>Display measurement statistics</p>	<p>9. From the Measurements setup control window, touch Setup Statistics.</p> <p>10. From the Statistics control window, select Off, Mean, or All.</p> <p><i>Off</i> turns off measurement statistics</p> <p><i>Mean</i> displays the mean of measurements</p> <p><i>All</i> displays the Mean, Min, Max, and Standard Deviation of measurements</p> <p>11. To set the number of measurements included in the measurement statistics, touch Weight n=, and use the multipurpose knobs or keypad to set the weighting.</p>	

Overview	To take automatic measurements	Related control elements & resources
<p>Set measurement reference levels</p>	<p>12. From the Measurements control window, touch Setup Ref Levs to display the Reference Levels setup control window.</p> <p>13. To use these settings for all measurements, toggle the Use On All Meas button to On. To set different values for some measurements, toggle the Use On all Meas button to Off.</p> <p>14. To select how the oscilloscope determines the base and top of the waveform, touch Determine Base, Top Form Min-Max, Histogram, or Histogram mean.</p> <ul style="list-style-type: none"> ■ <i>Min-max</i> uses the highest and lowest values of the waveform record. This setting is best for examining waveforms that have no large, flat portions at a common value, such as sine waves and triangle waves — almost any waveform except for pulses. See Figure 3-32 on page 3-125. ■ <i>Histogram</i> selects the most common values above or below the midpoint. Since this approach ignores short term aberrations (overshoot, ringing, and so on), Histogram is the best setting for examining pulses. See Figure 3-32 on page 3-125. ■ Histogram mean. Calculates the mean value using all values either above or below the midpoint (depending on whether it is defining the high or low reference level). Histogram mean is best for examining eye patterns and optical signals. <p>15. To select the reference level units, touch Units Absolute or Percentage.</p> <ul style="list-style-type: none"> ■ Absolute sets the units to absolute values in user units. ■ Percentage sets the units as a percentage of the High/Low range. <p>16. To set the reference levels, touch HighRef, Mid Ref, Low Ref, or Mid2 Ref, and use the multipurpose knobs or keypad to set the levels.</p>	    

Overview	To take automatic measurements	Related control elements & resources
<p>Take a snapshot of measurements</p>	<p>17. From the Measurement setup control window, touch the Snapshot button to display a window of all single waveform measurements.</p> <p>Note: Snapshot measurements are taken on the selected waveform. The Snapshot window tells you the channel that the measurements are being taken on and the reference levels used.</p> <p>18. Snapshot measurements are not continuously updated. To update snapshot measurements, touch the Snapshot Again button.</p> <p>Phase, Delay, and Histogram measurements are not included in a snapshot.</p>	 
<p>For further assistance</p>	<p>19. Touch the Help button in the Measurements setup control window to access the online assistance.</p> <p>20. See <i>Appendix B: Automatic Measurements Supported</i>, on page B-1 for a list of the measurements and their definitions.</p>	 <p>See page 3-245 to learn about using online help.</p>

To Localize a Measurement

Use the procedure that follows to take a measurement over a segment of the waveform (otherwise, the entire waveform feeds the measurement).

Overview	To gate a measurement	Related control elements & resources
<p>Prerequisites</p>	<p>1. Set up as from last procedure.</p>	 <p>See <i>To Take Automatic Measurements</i> on page 3-127</p>
<p>Access gating</p>	<p>2. From the tool bar, select Meas, and then select Gating from the Measurement setup control window. See right.</p>	 

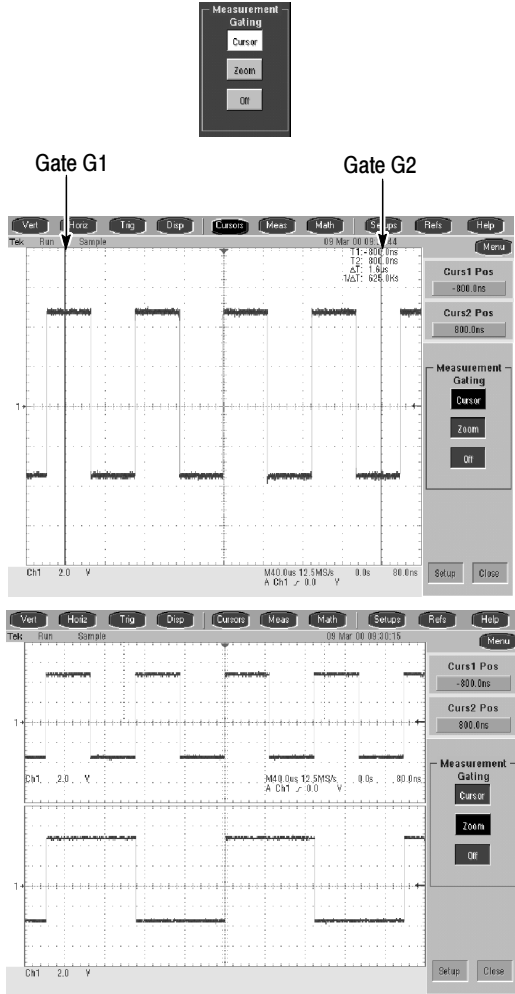
Overview	To gate a measurement	Related control elements & resources
<p>Enable & position the gates</p>	<p>3. To select how to control the gated area, touch Measurement Gating Cursor, Zoom, or Off:</p> <p><i>Cursor</i> sets the gated area to the area between the cursors. Use the multipurpose knobs to adjust the cursors on screen such that the area to measure is between the cursors.</p> <p><i>Zoom</i> sets the gated area to the waveform area contained in the Zoom graticule.</p> <p><i>Off</i> turns off measurement gating.</p> <p>Tip. Turning V Bar cursors off will not turn gating off. You must turn gating off in the Measurement Gating control window or the Zoom drop-down list.</p>	

Taking Cursor Measurements

Because cursor measurements give immediate feedback of the amplitude or time values they measure, they are usually quick to take and are more accurate than graticule measurements. Because you position cursors wherever you want them on the waveform, they are easier to localize to a waveform segment or feature than automatic measurements.

You can measure time or amplitude or both. Vertical cursors measure time or distance on screen, horizontal cursors measure voltage or amplitude, and paired cursors measure both. Table 3-9 expands on these definitions.

Table 3-9: Cursor functions (types)

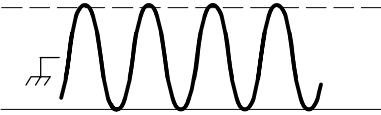
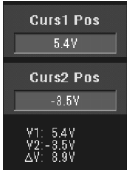
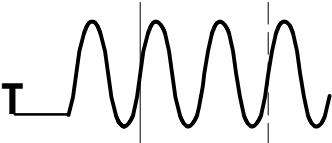
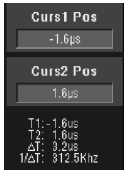
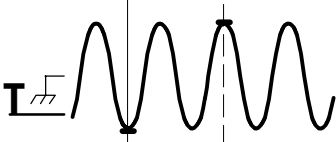
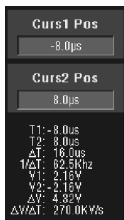
Cursor function	Parameter measured	Cursor readout
 <p>Horizontal cursors</p>	<p>Horizontal cursors measure amplitude (volts, watts). Each cursor measures with respect to:</p> <ul style="list-style-type: none"> ■ V1 = Level @ Cursor 1 with respect to its source ground level ■ V2 = Level @ Cursor 2 with respect to its source ground level ■ ΔV = Level @ Cursor 2 - Level at Cursor 1 <p>Level is cursor displacement from the source ground times the source volts/div. Note that the two cursors may have different sources and therefore can have different volts/div settings.</p>	
 <p>Vertical cursors</p>	<p>Vertical cursors measure distance (time in seconds or bits). Each cursor measures with respect to:</p> <ul style="list-style-type: none"> ■ T1 = Time @ Cursor 1 with respect to the trigger point ■ T2 = Time @ Cursor 2 with respect to the trigger point ■ ΔT = Time @ Cursor 2 - Time @ Cursor 1 <p>Time is divisions of displacement of the cursor from its source trigger point times the source time/div.</p>	
 <p>Paired (and Split) cursors</p>	<p>Paired cursors measure both voltage and time. Each cursor is, in effect, both a vertical and horizontal cursor. These paired cursors cannot be moved off the waveform.</p> <p>Note that Split cursors are the same as paired cursors except that the second cursor is on a different waveform than the first cursor. The sources can have different volts/div settings.</p>	

Cursors can measure channel, reference, and math waveforms. You must set the source of each cursor explicitly in the Cursor Setup control window.

Cursors are not available with histograms, XY, or XYZ modes.

Using Cursors

Cursor operation is easy, you move the cursors on screen and read the results in the cursor readouts. The following key points will help you use the cursors effectively:

Cursor Types. The cursor types are described in Table 3-9 on page 3-132. There are two cursors displayed for all types, Cursor 1 and Cursor 2. You can move cursors with the multipurpose knobs or the cursor position controls in the Cursor Setup control window.

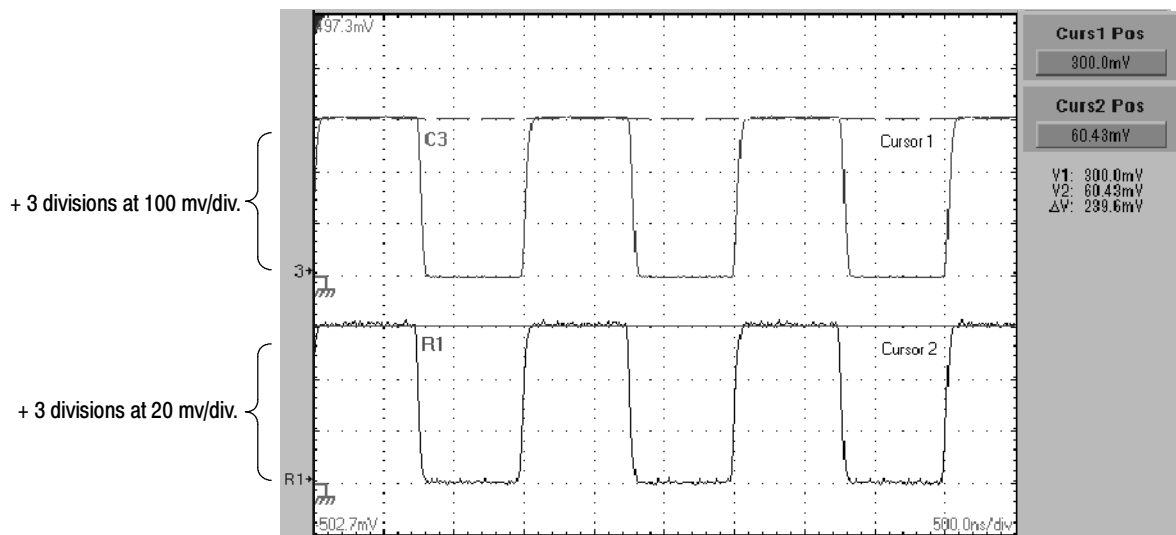

Figure 3-34: Horizontal cursors measure amplitudes

Cursors are Display-Limited. You cannot move a cursor off screen. Also, if you resize waveforms, the cursors do not track. That is, a cursor stays at its screen position, ignoring changes to horizontal and vertical scale and position, and vertical offset (paired and split cursors will track a waveform vertically).

Cursors Ignore the Selected Waveform. Each cursor measures its source, defined in the Cursors Setup dialog box. Selecting a waveform for scaling on screen (by pushing the CH 3 front-panel button, for example) does not change the source that each cursor measures.

After you have selected the source from the Cursors Setup control window, you can operate the cursor from the front-panel knobs and buttons.

Cursors Treat Sources Independently. Each cursor can take a different, independent source, with each source having its own amplitude scale. Consider the example presented by Figure 3-34 on page 3-133:

- Cursor 1 is set to measure channel 3 (Ch3), which is set to 100 mV per division, so cursor readout v1 measures Ch3 relative to its ground as 3 divisions x 100 mV/div, or about 300 mV.
- Cursor 2 is set to measure reference 4 (Ref4), which is set to 20 mV per division, so cursor readout v2 measures R4 relative to its ground as 3 divisions x 20 mV/div, or about 60 mV.
- Note that the value of each graticule division is not readily apparent relative to the delta readout, because the delta-amplitude readout (Δv) must account for the different amplitude-scale settings of the sources. To do so, the Δv readout displays the results of $v2 - v1$ ($60 \text{ mV} - 300 \text{ mV} = -240 \text{ mV}$), automatically accounting for the different scales of the cursor sources.

NOTE. If a cursor readout does not seem correct, check the source of each cursor in the Cursor setup dialog box. Each cursor readout relates to the amplitude and timebase settings of its source.

Vertical Cursors Measure from the Trigger Point. Remember that each vertical cursor measures the time from the trigger point to itself. This relationship is shown in Figure 3-35 on page 3-134.

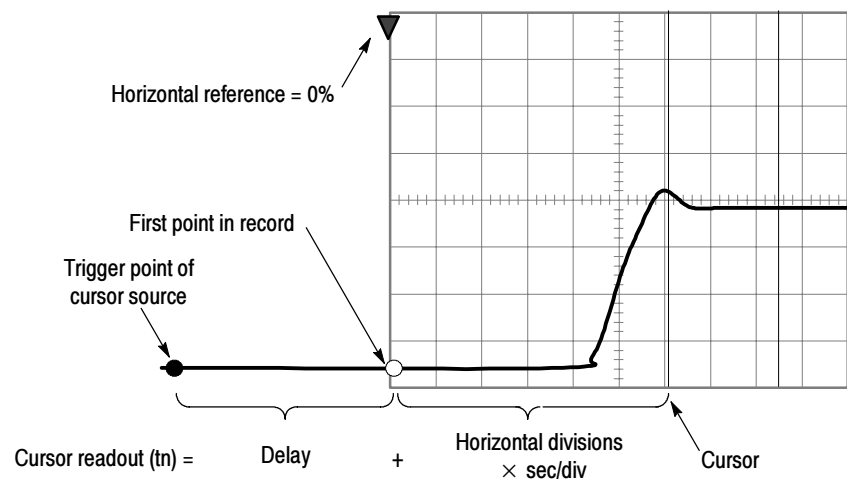

Figure 3-35: Components determining Time cursor readout values

Note that a vertical cursor readout includes and varies directly with the Time-to-First-Point component, which varies directly with the horizontal position set for the timebase. To see the amount of time to the first point, set Horizontal DELAY to 0.0 and set Horizontal Ref to 0%. Now the Horizontal position readout shows

the time following the first point, and adding this value to the cursor readout yields the cursor position on screen relative to first point. (You can find the horizontal readout both in the control window and in the readout at the bottom of the screen.) The following relationships hold:

Time from First Point = Horiz. Position (when Horiz. Delay and Ref Position are zero)

T1 readout = Time to First Point + Additional Time to Cursor

Cursor Units Depend on Sources. A cursor that measures amplitude or time will read out in the units of its source as indicated in Table 3-10. Note mixed sources require Delta-Cursor readouts to follow units of the cursor 1 source.

Table 3-10: Cursor units

Cursors	Standard units¹	Readout names
Horizontal	volts, watts	V1, V2, ΔV
Vertical	seconds, bits	T1, T2, ΔT , F, ΔF
Paired, Split	volts, watts, seconds, bits	V1, V2, ΔV , T1, T2, ΔT





¹ **If the V1 and V2 units do not match, the ΔV readout defaults to the units used by the V1 readout.**





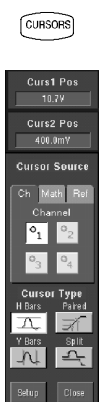

Multipurpose knobs. You can change cursor position using the position controls in the Cursor setup window, dragging the cursor into position using the touch screen or mouse, or by turning the front-panel multipurpose knobs.

The multipurpose knobs also work with other controls. If a setup window item has an adjustable value, you can adjust it with the multipurpose knob or keypad after touching the setup control.

NOTE. *To make small changes with the multipurpose knobs, push the FINE button before turning the knob. When a FINE button is illuminated, its multipurpose knob makes smaller adjustments.*

To Set the Cursor Sources You must target the cursors to the source they are to measure. (See *Cursors Treat Sources Independently* on page 3-133). To do so, use the procedure that follows.

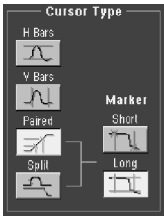
Overview	To set the cursor sources	Related control elements & resources
<p>Prerequisites</p>	<p>1. Display the waveforms to measured on screen. The waveform may be a channel, reference, or math waveform.</p>	 <p>See page 3-27 for acquisition setup & page 3-53 for trigger setup.</p>
<p>Display the cursor controls window</p>	<p>2. Push the CURSORS front-panel button, or from the tool bar, touch Cursors.</p>	
<p>Select the cursor sources</p>	<p>3. From the Cursor Source menu, select the channel, math, or reference tab and then the waveform to take cursor measurements on (see right). If you are using Split cursors, you must select a source for both cursors by first touching a cursor button before selecting a source.</p> <p>Tip. If a waveform is not available, its source button is grayed out.</p>	
<p>Select a cursor type</p>	<p>4. From the Cursor Type menu, select the H Bars, V Bars, Paired, or Split cursor type. See Table 3-9 on page 3-132 for an explanation of the cursor types.</p>	
<p>Change cursor position</p>	<p>5. To change the position of a cursor, use the multipurpose knobs or the keypad to move a cursor.</p>	

Overview	To set the cursor sources (Cont.)	Related control elements & resources
<p>Set cursor tracking</p>	<p>6. To change the cursor tracking mode, from the Cursor controls window select Setup.</p> <p>7. Touch Track Mode Indep or Tracking: <i>Indep</i> makes each cursor positionable without regard to the position of the other cursor. <i>Tracking</i> makes both cursors move in unison and maintain a fixed horizontal or vertical distance between each other.</p> <p>8. To return to the Cursor controls window, touch the Controls button.</p> <p>9. To toggle the display of cursors on or off, touch the Cursor button.</p> <p>Tip. All adjustments that you can make in the Cursor controls window can also be made in this window.</p>	   
<p>Set cursor length</p>	<p>10. To change the paired and split cursor marker length, from the Cursor controls window, select Setup.</p> <p>11. Touch Cursor Type Marker Short or Long.</p>	 
<p>For further assistance</p>	<p>12. Touch the Help button in the Cursor setup control window or the Cursor controls window to access the online assistance.</p>	 <p>See page 3-245 to learn about using online help.</p>

Taking Histograms

The oscilloscope can display histograms constructed from the selected waveform data. You can display both vertical (voltage) and horizontal (time) histograms, but only one at a time. Use histogram measurements to get statistical measurement data for a section of a waveform along one axis.

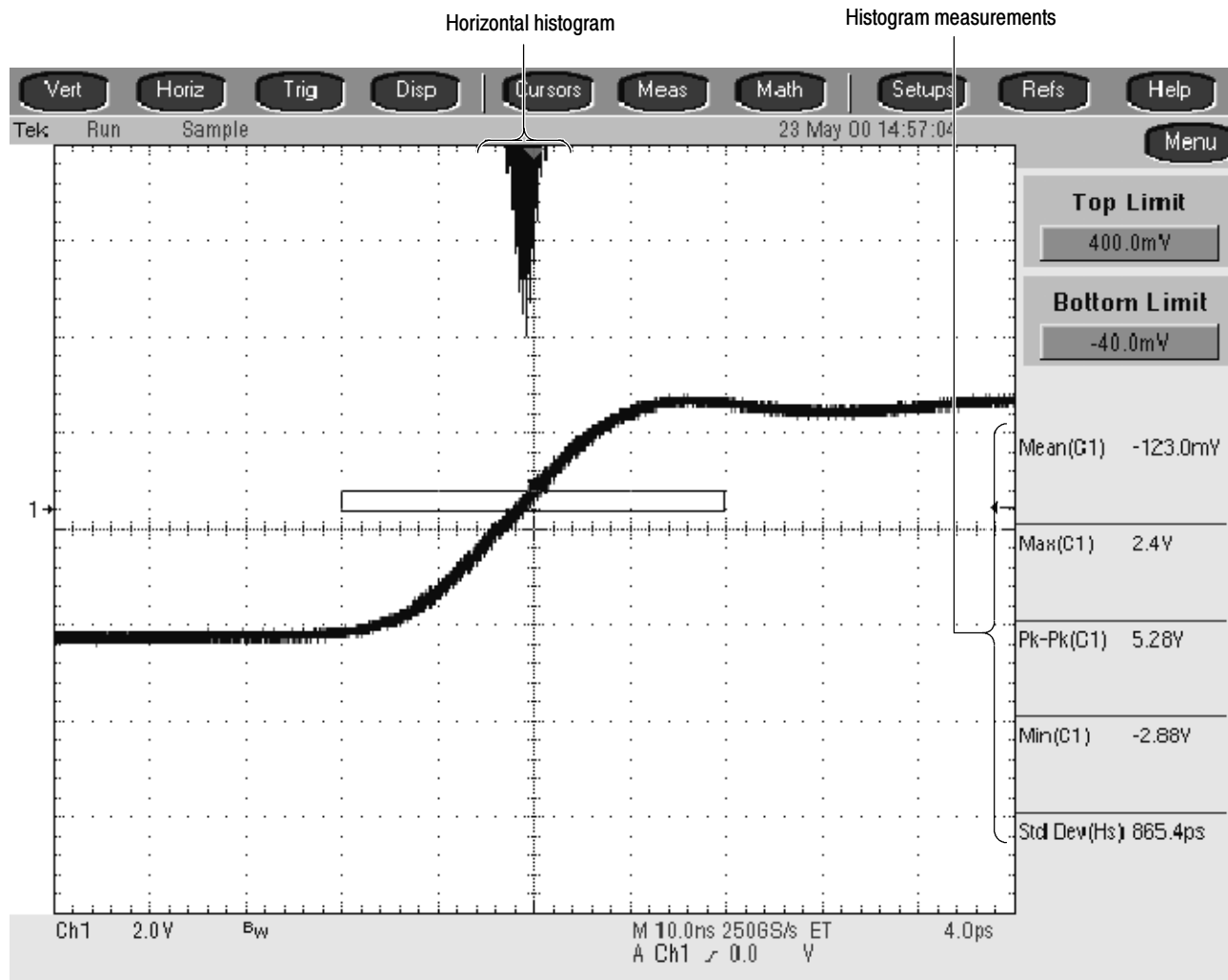

Figure 3-36: Horizontal histogram view and measurement data

A histogram source can be any waveform (channel or math), including a reference waveform.

In addition to using limit controls to set histogram box boundaries, you can also use standard Windows drag-and-drop to resize and reposition the histogram box.

Histograms are not available in FastFrame or Zoom modes.





Using Histograms

Histogram Size. The maximum vertical histogram size is 200. The maximum horizontal size is 500.

Histogram Counting Stays On. Turning on histograms starts histogram counting and data accumulation. A sample histogram display is shown in Figure 3-36. Histogram data is continuously accumulated until you explicitly turn off histograms. This allows you to continue collecting histogram data even when you turn off the histogram display.

To Start and Reset Histogram Counting

Use the procedure that follows to quickly take a measurement based on the default settings for histograms.

Overview	To start and reset histogram counting	Related control elements & resources
<p>Prerequisites</p>	<p>1. The oscilloscope must have a waveform displayed.</p>	 <p>See page 3-102 for information on displaying waveforms.</p>
<p>Open histogram setup window</p>	<p>2. From the tool bar, touch the Meas button, and then touch the Histogram button to display the Histogram setup window.</p>	
<p>Set, display, and reset histogram source and type</p>	<p>3. Select either the Source Ch, Math, or Ref tab and then select the waveform source for the histogram.</p> <p>4. Touch either Histogram Mode Horiz or Vert to start histogram counting and display the histogram data:</p> <p><i>Horiz</i> displays a horizontal histogram that shows how time varies in the histogram box</p> <p><i>Vert</i> displays a vertical histogram that shows how your vertical units vary in the histogram box</p> <p><i>Off</i> turns off histogram counting and display</p> <p>Note that this control turns on histogram counting and data display. You can only display one type of histogram at a time.</p> <p>5. Touch Reset to reset the histogram count. Histograms track numbers of counts. Clicking Reset resets those counts to zero and begins counting from zero.</p>	  

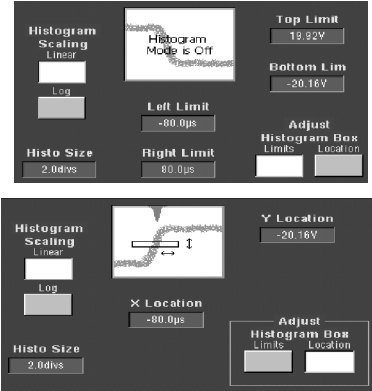
Overview	To start and reset histogram counting	Related control elements & resources
<p>Set histogram display options</p>	<p>6. Touch Display to toggle the display of the selected histogram on and off.</p> <p>7. Select Linear to display histogram data linearly. Bin counts smaller than the maximum counts are scaled linearly by dividing the bin count by the maximum bin count.</p> <p>8. Select Log to display histogram data logarithmically. Bin counts smaller than the maximum counts are scaled logarithmically. Logarithmic scaling provides better visual details for bins with low counts.</p>	
<p>Set histogram limit controls</p>	<p>9. Touch Adjust Histogram Box Limits and use the Top Limit, Bottom Limit, Left Limit, and Right Limit controls to set the size of the histogram box. The histogram box selects the section of the waveform used for histograms.</p> <p>10. Touch Adjust Histogram Box Location and use the X Location and Y Location controls to set the location of the histogram box.</p>	

Histogram Measurements

Table B-1 on page B-1 includes a list of the available histogram measurements and a brief description of each.



Optimizing Measurement Accuracy

The procedures given here will increase the accuracy of the measurements you take.

This oscilloscope can compensate itself and the attached probes, optimizing the internal signal path used to acquire the waveforms you measure. Compensation optimizes the capability of the oscilloscope to take accurate measurements based on the ambient temperature.

To Compensate the Oscilloscope

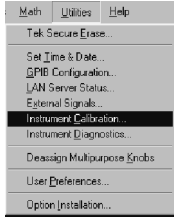
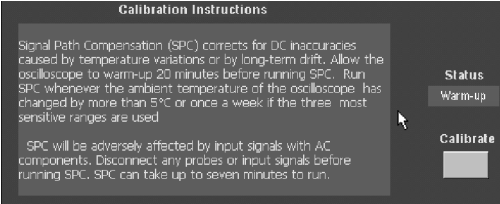
To compensate the oscilloscope so that it can take accurate measurements based on the ambient temperature, use the procedure that follows.



Overview	To compensate the oscilloscope	Related control elements & resources
<p>Prerequisites</p>	<p>1. Oscilloscope should be powered on. Allow a 20 minute warm up. Remove all input signals.</p>	 <p>See page 3-27 for acquisition setup & <i>Power on the Oscilloscope</i> on page 1-8.</p>
<p>Display the calibration instructions</p>	<p>2. From the menu bar, select Utilities, and then select Instrument Calibration. See right.</p>	
<p>Check the calibration status</p>	<p>3. The calibration status should be Pass. If the status is Warm-up, wait until the status changes. If the status does not change to Pass, use the following steps to calibrate the oscilloscope.</p> <p>Note: Signal Path Compensation is the only calibration that is accessible to users.</p>	
<p>Calibrate the oscilloscope</p>	<p>4. Touch Calibrate to start the calibration. Calibration may take several minutes. Calibration is complete after Working is no longer displayed in the Calibrate button and Running is no longer displayed in the Status readout.</p>	
<p>Check the calibration status</p>	<p>5. The calibration status should be Pass. If not, recalibrate the oscilloscope, or have the oscilloscope serviced by qualified service personnel.</p>	
<p>For further assistance</p>	<p>6. Touch the Help button to access the online assistance.</p>	 <p>See page 3-245 to learn about using online help.</p>

To Connect the Probe Calibration Fixture

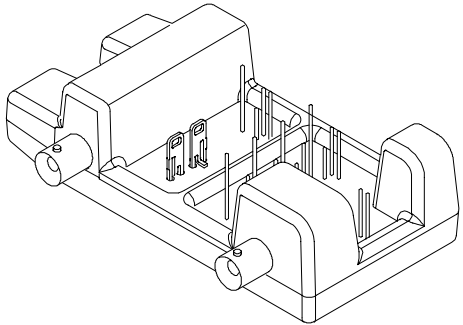
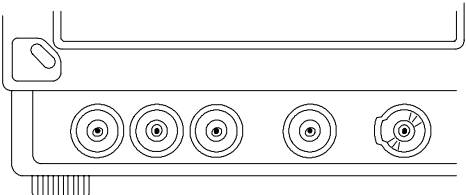
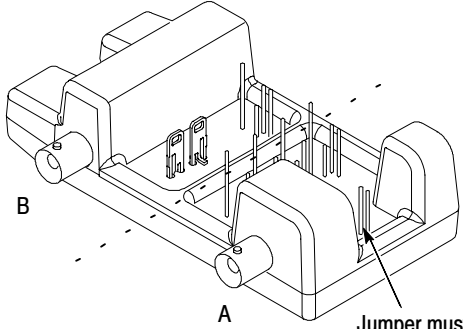
To compensate or calibrate probes you must connect the Probe Calibration and Deskew Fixture to the oscilloscope; use the procedure that follows.

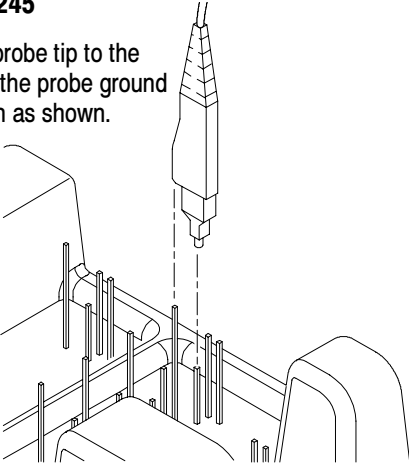
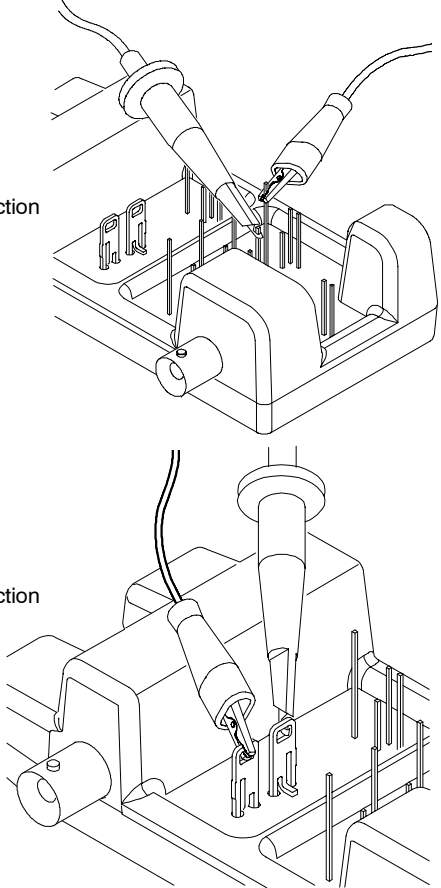

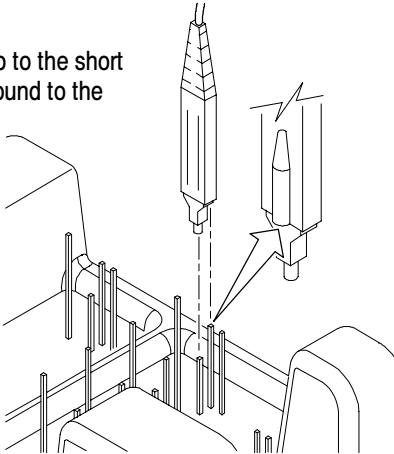
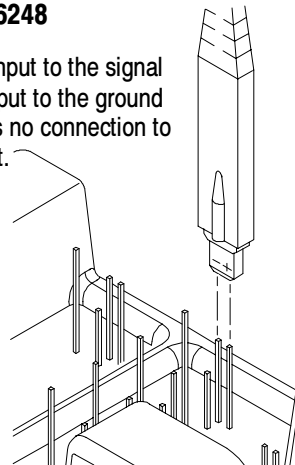
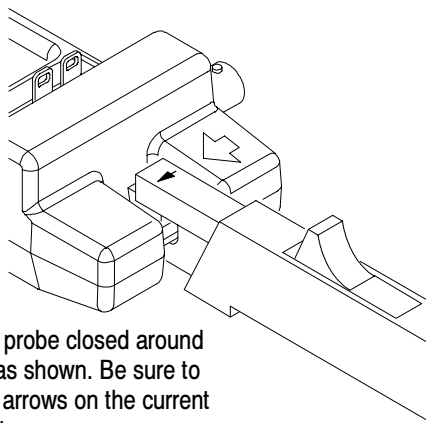
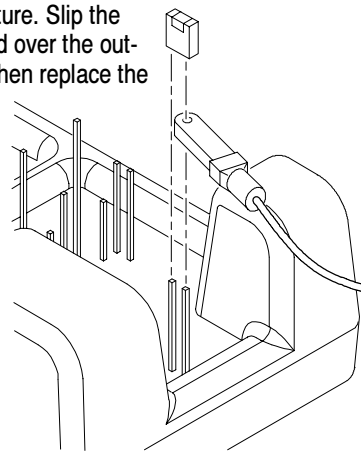
Overview	To connect the probe calibration fixture	Related control elements & resources																												
<p>Prerequisites</p>	<p>1. Oscilloscope should be powered on. Allow a 20 minute warm up.</p>	 <p>See page 3-27 for acquisition setup & <i>Power on the Oscilloscope</i> on page 1-8.</p>																												
<p>Overview</p>	<p>This fixture converts the TDS7000 Series PROBE COMPENSATION output into a set of test points that give you a convenient way to:</p> <ul style="list-style-type: none"> ■ Optimize the oscilloscope gain and offset accuracy at the probe tip (see <i>To Calibrate Probes</i> on page 3-146). ■ Compensate (low-frequency) a passive probe (see <i>To Compensate Passive Probes</i> on page 3-148). ■ Compensate for timing differences (deskew) between probes (see <i>To Deskew Channels</i> on page 3-148). 																													
<p>Connect the fixture</p>	<p>2. Connect the oscilloscope PROBE COMPENSATION output to either the A or B input using the included BNC cable. The input you use depends on the type of probes you have and the operation you want to perform:</p> <table border="1" data-bbox="362 1245 963 1812"> <thead> <tr> <th>Probe</th> <th>Operation</th> <th>Input</th> </tr> </thead> <tbody> <tr> <td rowspan="4">Passive voltage probes, P6139A</td> <td>Low frequency compensation</td> <td>A</td> </tr> <tr> <td>Gain and offset calibration</td> <td>A</td> </tr> <tr> <td>Deskew voltage probes</td> <td>A</td> </tr> <tr> <td>Deskew TCP202 probe</td> <td>B</td> </tr> <tr> <td rowspan="5">Active voltage probes, P6243 P6245 P6246 P6247 P6248 P6249</td> <td>Deskew CT-6 probe</td> <td>A</td> </tr> <tr> <td>Gain and offset calibration</td> <td>A</td> </tr> <tr> <td>Deskew voltage probes</td> <td>A</td> </tr> <tr> <td>Deskew TCP202 probe</td> <td>B</td> </tr> <tr> <td>Deskew CT-6 probe</td> <td>A</td> </tr> <tr> <td rowspan="2">Current probes TCP202 CT-6</td> <td>Deskew voltage probes</td> <td>B</td> </tr> <tr> <td>Deskew voltage probes</td> <td>A</td> </tr> </tbody> </table>	Probe	Operation	Input	Passive voltage probes, P6139A	Low frequency compensation	A	Gain and offset calibration	A	Deskew voltage probes	A	Deskew TCP202 probe	B	Active voltage probes, P6243 P6245 P6246 P6247 P6248 P6249	Deskew CT-6 probe	A	Gain and offset calibration	A	Deskew voltage probes	A	Deskew TCP202 probe	B	Deskew CT-6 probe	A	Current probes TCP202 CT-6	Deskew voltage probes	B	Deskew voltage probes	A	 <p style="text-align: center;">PROBE COMPENSATION output</p>  <p style="text-align: right;">Jumper must be installed</p> <p>Note: The P6339A probe is not supported.</p>
Probe	Operation	Input																												
Passive voltage probes, P6139A	Low frequency compensation	A																												
	Gain and offset calibration	A																												
	Deskew voltage probes	A																												
	Deskew TCP202 probe	B																												
Active voltage probes, P6243 P6245 P6246 P6247 P6248 P6249	Deskew CT-6 probe	A																												
	Gain and offset calibration	A																												
	Deskew voltage probes	A																												
	Deskew TCP202 probe	B																												
	Deskew CT-6 probe	A																												
Current probes TCP202 CT-6	Deskew voltage probes	B																												
	Deskew voltage probes	A																												



Overview	To connect the probe calibration fixture (Cont.)	Related control elements & resources
<p>Connect the probe</p>	<p>WARNING. To avoid personal injury, use care while connecting probe tips to the square pins on the fixture. The ends of the square pins are sharp.</p> <p>Refer to these diagrams to attach your probe tip to the fixture. Refer to the ground symbols on the fixture to establish the correct polarity.</p> <p>P6243 or P6245</p> <p>Connect the probe tip to the short pin and the probe ground to the long pin as shown.</p> 	<p>P6139A</p> <p>Connect the probe tip and the ground lead to the two terminals as shown.</p>  <p>A side connection</p> <p>B side connection</p>

Overview	To connect the probe calibration fixture (Cont.)	Related control elements & resources
	<p>P6249</p> <p>Connect the probe tip to the short pin and the probe ground to the long pin as shown.</p> 	<p>P6246, P6247, or P6248</p> <p>Connect the probe + input to the signal pin and the probe - input to the ground pin as shown. There is no connection to the probe ground input.</p> 
	<p>TCP-202</p>  <p>Snap the current probe closed around the current loop as shown. Be sure to align the polarity arrows on the current probe and the fixture.</p>	<p>CT-6</p> <p>Remove the small jumper on the A side of the fixture. Slip the CT-6 probe head over the out-board pin, and then replace the jumper.</p>  <p>After you are finished with this probe, be sure to replace the small jumper. The A side of the fixture will not operate without it.</p>
<p>For further assistance</p>	<ol style="list-style-type: none"> 3. To optimize the oscilloscope gain and offset accuracy at the probe tip, see <i>To Calibrate Probes</i> on page 3-146. 4. To compensate (low-frequency) a passive probe, see <i>To Compensate Passive Probes</i> on page 3-148. 5. To compensate for timing differences (deskew) between probes, see <i>To Deskew Channels</i> on page 3-148. 	 <p>See page 3-245 to learn about using online help.</p>

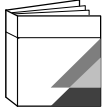
To Calibrate Probes

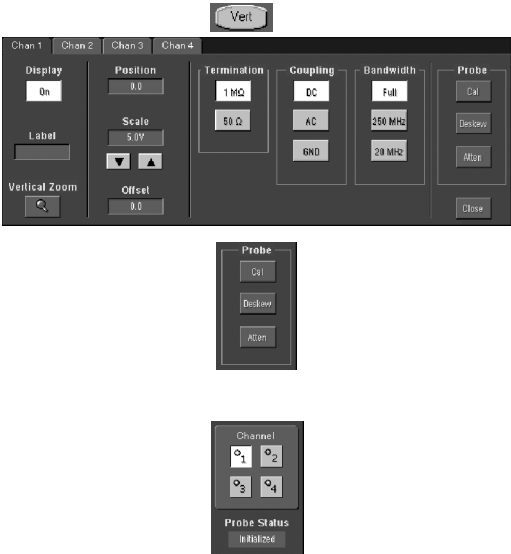

To compensate the oscilloscope so that it can take accurate measurements based on the ambient temperature, use the procedure that follows.

Overview	To calibrate probes	Related control elements & resources
<p>Prerequisites</p>	<p>1. Oscilloscope should be powered on. Allow a 20 minute warm up.</p> <p>Note: Probes with an attenuation factor of greater than 20X cannot be compensated. Probes with >2% gain errors or >50 mV offset errors cannot be compensated.</p>	 <p>See page 3-27 for acquisition setup & <i>Power on the Oscilloscope</i> on page 1-8.</p>
<p>Optimize gain and offset accuracy</p>	<ol style="list-style-type: none"> 2. Connect fixture to the oscilloscope (see <i>To Connect Probe Calibration Fixture</i> on page 3-143). 3. Remove the small jumper from the fixture. 4. Connect one probe to the fixture. 5. If compensating a passive probe, first perform the <i>To Compensate Passive Probes</i> procedure on page 3-148. 6. From the tool bar, touch the VERT button to display the oscilloscope Vertical setup control window. 7. Touch the Probe Cal button to display the vertical Probe Cal control window. 8. Select the oscilloscope channel to which the probe is attached. 9. Touch Clear Probecal Erase to erase any previous calibration data. 10. Touch the Calibrate Probe button. 11. When the routine is finished, remove the connections and replace the small jumper. 	 <p>The image shows two screenshots from an oscilloscope interface. The top screenshot is the 'Vertical' setup window, which includes sections for 'Display' (On), 'Position' (0.0), 'Scale' (5.0V), 'Offset' (0.0), 'Termination' (1 MΩ, 50 Ω, GND), 'Coupling' (DC, AC, GND), 'Bandwidth' (Full, 250 MHz, 20 MHz), and 'Probe' (Cal, DeCal, Auto). The bottom screenshot is the 'Probe Cal' control window, showing 'Channel' selection (1-4), 'Probe Status' (Initialized), 'Clear Probecal' (Erase), and 'Calibrate Probe' buttons.</p>

Overview	To calibrate probes (Cont.)	Related control elements & resources
<p>Check the calibration status</p>	<p>12. From the tool bar, touch the VERT button to display the oscilloscope Vertical setup control window.</p> <p>13. Touch the Probe Cal button to display the vertical Probe Cal control window.</p> <p>14. Select the oscilloscope channel to which the probe is attached.</p> <p>15. Check the Probe Status readout. See right.</p> <p><i>Initialized</i> indicates that the probe has not been calibrated on the selected channel.</p> <p><i>Pass</i> indicates that the probe has been calibrated on the selected channel.</p> <p>Note: Probes without a TekProbe interface cannot be calibrated.</p>	
<p>For further assistance</p>	<p>16. Touch the Help button to access the online assistance.</p>	 <p>See page 3-245 to learn about using online help.</p>

To Compensate Passive Probes

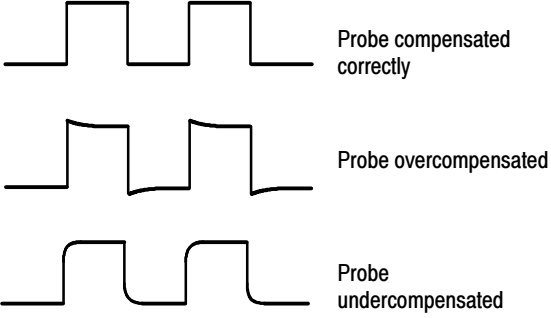
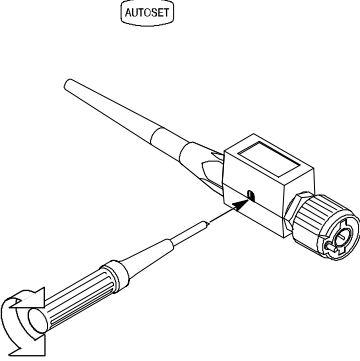



To compensate the passive probes to ensure maximum distortion-free input to the oscilloscope and to avoid high frequency amplitude errors, use the procedure that follows.

Overview	To compensate passive probes	Related control elements & resources
<p>Prerequisites</p>	<p>1. Oscilloscope should be powered on. Allow a 20 minute warm up.</p>	 <p>See page 3-27 for acquisition setup & <i>Power on the Oscilloscope</i> on page 1-8.</p>
<p>Low frequency compensation</p>	<p>2. Connect fixture to the oscilloscope (see <i>To Connect Probe Calibration Fixture</i> on page 3-143).</p> <p>3. Connect one probe to the fixture.</p> <p>4. Push the AUTOSET button on the oscilloscope.</p> <p>5. Adjust the probe compensation box for best square corner:</p>  <p>6. Remove the connections.</p>	
<p>For further assistance</p>	<p>7. Touch the Help button to access the online assistance.</p>	 <p>See page 3-245 to learn about using online help.</p>

To Deskew Channels

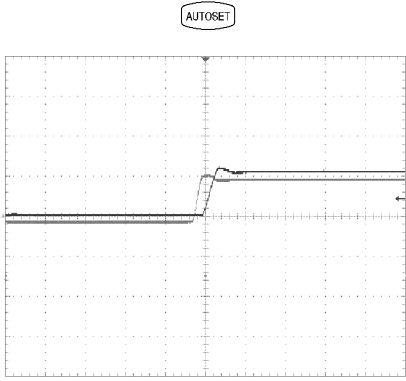
You can adjust a relative time delay for each channel. This lets you align the signals to compensate for signals that may come in from cables of differing lengths. The oscilloscope applies deskew values after it completes each acquisition; therefore, the deskew values do not affect logic triggering. Also, deskew has no affect on XY and XYZ display formats.

Overview	To deskew channels	Related control elements & resources
<p>Prerequisites</p>	<p>1. Oscilloscope should be powered on. Allow a 20 minute warm up.</p>	<div data-bbox="1166 369 1268 478" data-label="Image"> </div> <p>See page 3-27 for acquisition setup & <i>Power on the Oscilloscope</i> on page 1-8.</p>

Overview	To deskew channels	Related control elements & resources
<p>Compensate probe timing (deskew)</p>	<ol style="list-style-type: none"> 2. Connect fixture to the oscilloscope (see <i>To Connect Probe Calibration Fixture</i> on page 3-143). The fixture's jumper must be installed. 3. Connect up to four probes to the fixture. 4. Display all the channels that you want to deskew. 5. Push the AUTOSET button on the oscilloscope. 6. Adjust Vertical SCALE and POSITION for each channel so that the signals overlap and are centered on screen. 7. Adjust horizontal POSITION so that a triggered rising edge is at center screen. 8. Adjust horizontal SCALE so that the differences in the channel delays are clearly visible. 9. Adjust horizontal POSITION again so that the first rising edge is exactly at center screen. The fastest probe is connected to this channel. (The fastest probe is probably the one with the shortest cable or the highest bandwidth.) 10. From the tool bar, touch the VERT button to display the Vertical setup control window. 11. Touch the Probe Deskew button to display the channel-deskew control window. 12. Select one of the slower channels. NOTE. Do the next step at a signal amplitude within the same attenuator range (vertical scale) as your planned signal measurements. Any change to the vertical scale after deskew is complete may introduce a new attenuation level (you can generally hear attenuator settings change) and therefore a slightly different signal path. This different path may cause a 200 ps variation in timing accuracy between channels. 13. Touch Deskew Time and use the multipurpose knobs or keypad to adjust the deskew time for that channel so that its signal aligns with that of the fastest channel. 14. Repeat steps 12 and 13 for each additional channel that you want to deskew. 15. Remove the connections. 	   

Overview	To deskew channels	Related control elements & resources
<p>For further assistance</p>	<p>16. Touch the Help button to access the online assistance.</p>	<div data-bbox="1166 367 1295 472" data-label="Image"> </div> <p data-bbox="1036 499 1437 529">See page 3-245 to learn about using online help.</p>

Serial Mask Testing (Option SM Only)

The oscilloscope provides a portfolio of masks for verifying compliance to optical and electrical standards. You can verify circuit design performance and perform interface compliance testing. Mask testing results are reported live, providing real time feedback. Mask hits are highlighted on the display and accompanied by readouts indicating the number of waveforms tested, pass/fail results, and hit counts.

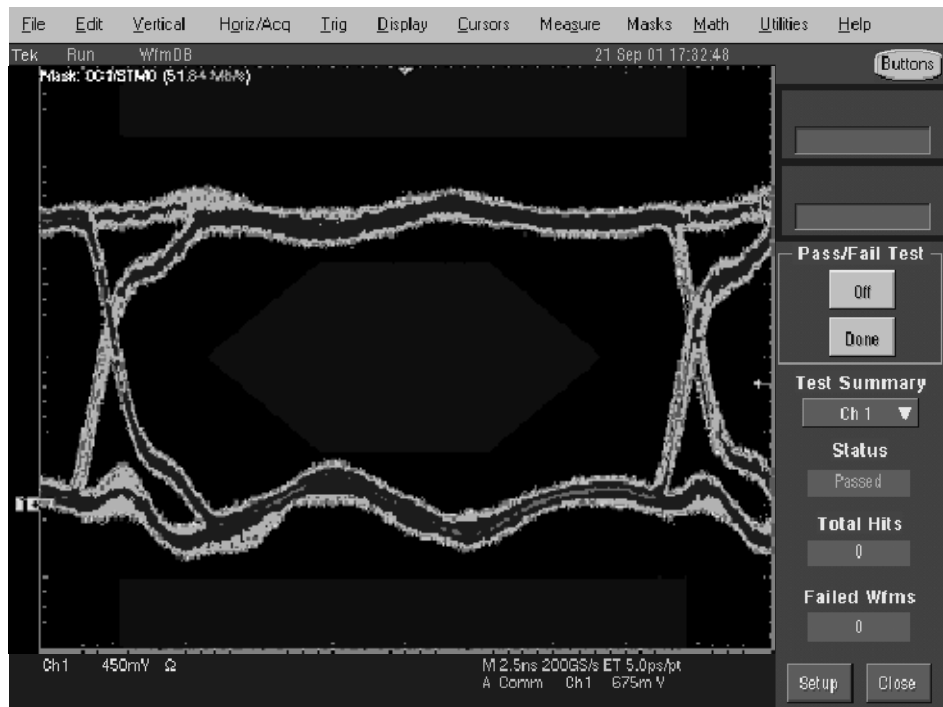

Figure 3- 37: Pass/Fail mask testing

If the Bessel-Thompson filter is on, the instrument is an optical reference receiver.

For detailed information on using Serial Mask Testing to test your signals for compliance to optical and electrical standards see the *CSA7000, TDS7000 & TDS6000 Series Option SM Serial Mask Testing and Option ST Serial Triggering User Manual*.

Creating and Using Math Waveforms

Once you have acquired waveforms or taken measurements on waveforms, the oscilloscope can mathematically combine them to create a waveform that supports your data-analysis task. For example, you might have a waveform clouded by background noise. You can obtain a cleaner waveform by subtracting the background noise from your original waveform (note that the background noise you subtract must be identical to the noise in your signal). Or, you can integrate a single waveform into an integral math waveform as shown below.

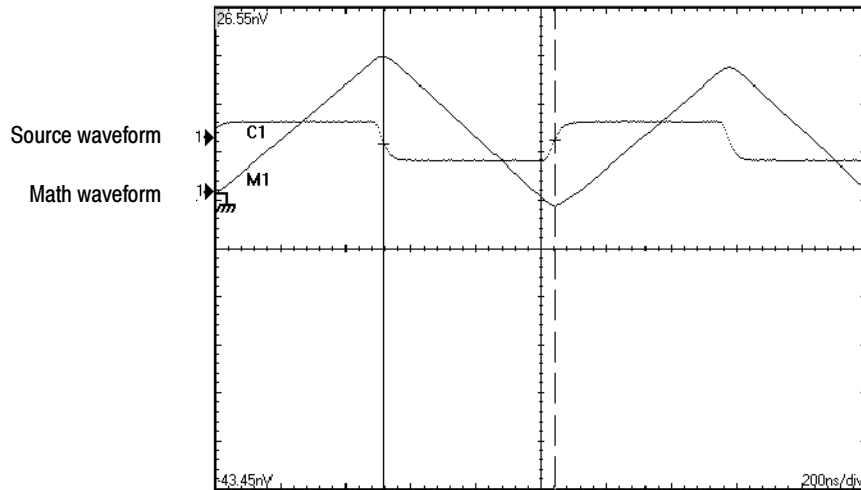

With spectral analysis you can analyze waveforms in the frequency domain. The interface is similar to a dedicated spectrum analyzer, relieving you of the burden of knowing the details of the underlying algorithms (see Figure 3-38).

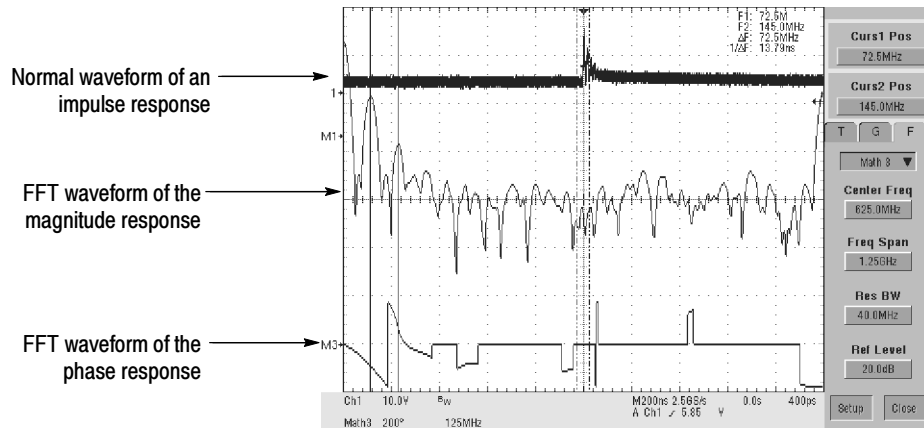

Figure 3-38: Spectral analysis of an impulse

Defining Math Waveforms

This oscilloscope supports mathematical combination and functional transformations of waveforms it acquires. Figure 3-39 shows this concept:

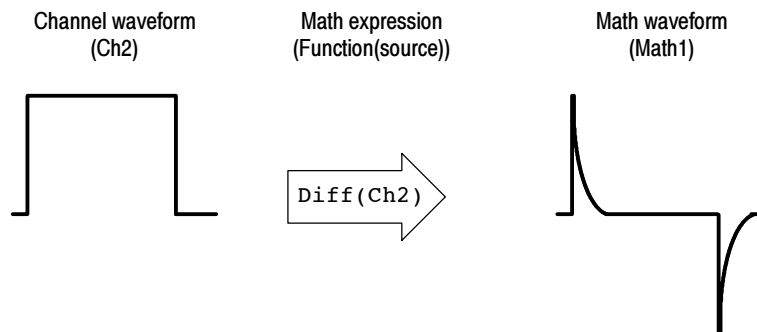

Figure 3-39: Functional transformation of an acquired waveform

You create math waveforms to support the analysis of your channel and reference waveforms. By combining and transforming source waveforms and other data into math waveforms, you can derive the data view that your application requires. You can create math waveforms that result from:

- Mathematical operations on one or several waveforms: add, subtract, multiply, and divide.
- Function transforms of waveforms, such as integrating, differentiating, and so on.

- spectral analysis of waveforms, such as an impulse.

You can create up to four math waveforms; see *Using Math* on page 3-155 for more examples.

Math waveforms can be used in other math. Math waveforms autoscale when the math waveform is first defined and turned on. Advanced functions, such as integrate, differentiate, average, square root, and log, can be taken on single waveforms or complicated expressions.

Measurement scalars can be used in expression; for example, you can use the measurement feature this oscilloscope provides to measure the average of a waveform and subtract it from the original waveform to define a new math waveform.

In FastFrame, math is applied to each frame.

Some operations that you cannot use with math waveforms follow:

- **Circular Math-on-Math, Measurements in Math, and Measurements on Math** - You cannot use circular definitions of math waveforms. For example, if you define $\text{Math2} = \text{Ch1} - \text{Math1}$, and then define a second math waveform as $\text{Math3} = \text{Ch2} + \text{Math2}$, you cannot define a third math waveform as $\text{Math1} = \text{Math2} + \text{Ch3}$. If you do, the Math1 definition is rejected with an error because a circular definition is not allowed.
- **Fast Acquisition** - Math is not allowed in Fast Acquisition mode.
- **Roll Mode** - Math is not allowed in Roll mode until you push stop.
- **Different Length Sources** - If you use two waveforms (channel and reference waveforms) of different lengths, the length of the math waveform will be the shorter of the two lengths.
- **Measurements** - Meas1 - Meas8 are allowed in a math definition, but not measurement functions (such as $\text{rise}(\text{Ch1})$).

Using Math

Read the following topics; they provide details, that if you know of them, can help you create the math waveform that best supports your data-analysis tasks.

How to Create. You create math waveforms when you create a math expression. You do so by applying numerical constants, math operators and functions to operands, which can be channel waveforms, reference waveforms, math waveforms, or measurements (scalars). You can display and manipulate these derived math waveforms much like you can the channel and reference waveforms (see *Operations on Math Waveforms* on page 3-163).

Some examples of typical math waveforms follow:

Table 3-11: Math expressions and the math waveforms produced

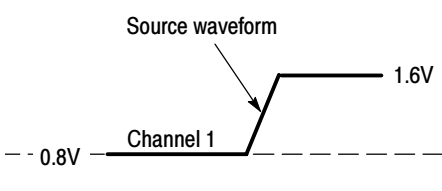
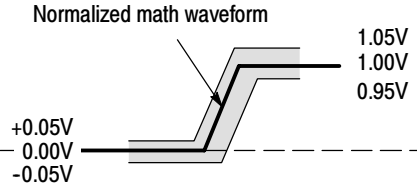
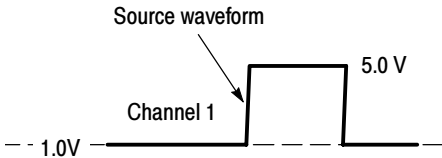
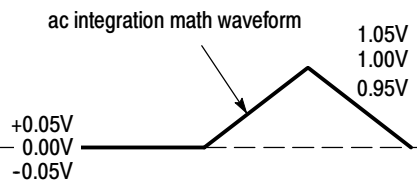
To . . .	Enter this math expression . . .	and get this math waveform . . .
<p>normalize a waveform</p> 	<p>...</p> <p>$(Ch1 - Meas1) / Meas2$, where Ch1 is the waveform shown at left Meas1 = Low of Ch1 Meas2 = amplitude of Ch1</p>	<p>shifted and scaled to fit a template</p> 
<p>simulate ac coupling</p> 	<p>...</p> <p>$Intg(Ch1 - Avg(Ch1))$, where Ch1 is the waveform shown at left Avg is the average function</p>	<p>ac component removed before integration</p> 

Sources. Math Waveforms can incorporate the following sources:

- Channel waveforms
- Reference waveforms
- Measurements (automated measurements) that measure channel, reference, histogram, or math waveforms.
- Math waveforms

Source Dependencies. In general, be aware that math waveforms that include sources as operands are affected by updates to those sources:

- Shifts in amplitude or DC level of input sources that cause the source to clip also clips the waveform data supplied to the math waveform.
- Changes to the vertical offset setting for a channel source that clip its data also clip the waveform data supplied to the math waveform.
- Changes to the acquisition mode globally affects all input channel sources, thereby modifying any math waveforms using them. For example, with the acquisition mode set to Envelope, a Ch1 + Ch2 math waveform will receive enveloped channel 1 and channel 2 data and, therefore, will also be an envelope waveform.

- Clearing the data in a waveform source causes a baseline (ground) to be delivered to any math waveform that includes that source until the source receives new data.

Expression Syntax. You build math waveforms using the Define/Edit Expression control window. To help you create valid math waveforms, this window blocks most illegal entries by disabling any window element that would create an invalid entry in the math waveform expression.

The syntax that follows describes valid math expressions, which can be quite complex (in excess of 100 characters long):

```

<MathWaveform> := <Expression>

<Expression> := <UnaryExpression> | <BinaryExpression>

<UnaryExpression> := <UnaryOperator> ( <Term> )
                  | <UnaryOperator> ( <Expression> )

<BinaryExpression> := <Term> <BinaryOperator> <Term> | <Scalar>
                   <BinaryOperator> <Term> | <Term> <BinaryOperator> <Scalar>

<Term> := <Waveform> | ( <Expression> )

<Scalar> := <Integer> | <Float> | <Meas-Result>

<Waveform> := <ChannelWaveform> | <ReferenceWaveform> | <MathWaveform>

<ChannelWaveform> := Ch1 | Ch2 | Ch3 | Ch4

<ReferenceWaveform> := Ref1 | Ref2 | Ref3 | Ref4

<MathWaveform> := Math1 | Math2 | Math3 | Math4

<UnaryOperator> := Invert | Derivative | Integral | Average | Max | Min
                | Filter | Vmag | Exp | log 10 | log e | sqrt | Spectral Magnitude
                | Spectral Phase | Spectral Real | Spectral Imag

<BinaryOperator> := + | - | / | * | == | != | < | <= | > | >= |

<Meas-Result> := meas1 | meas2 | meas3 | meas4 | meas5 | meas6 | meas7 | meas8
    
```

Waveform Differentiation. The math capabilities of the oscilloscope include *waveform differentiation*. This allows you to display a derivative math waveform that indicates the instantaneous rate of change of the waveform acquired.

Derivative waveforms are used in the measurement of slew rate of amplifiers and in educational applications. You can create a derivative math waveform and then use it as a source for another derivative waveform. The result is the second derivative of the waveform that was first differentiated.

The math waveform, derived from the sampled waveform, is computed based on the following equation:

$$Y_n = (X_{(n+1)} - X_n) \frac{1}{T}$$

- Where:
- X is the source waveform
 - Y is the derivative math waveform
 - T is the time between samples

Since the resultant math waveform is a derivative waveform (See Figure 3-40), its vertical scale is in volts/second (its horizontal scale is in seconds). The source signal is differentiated over its entire record length; therefore, the math waveform record length equals that of the source waveform.

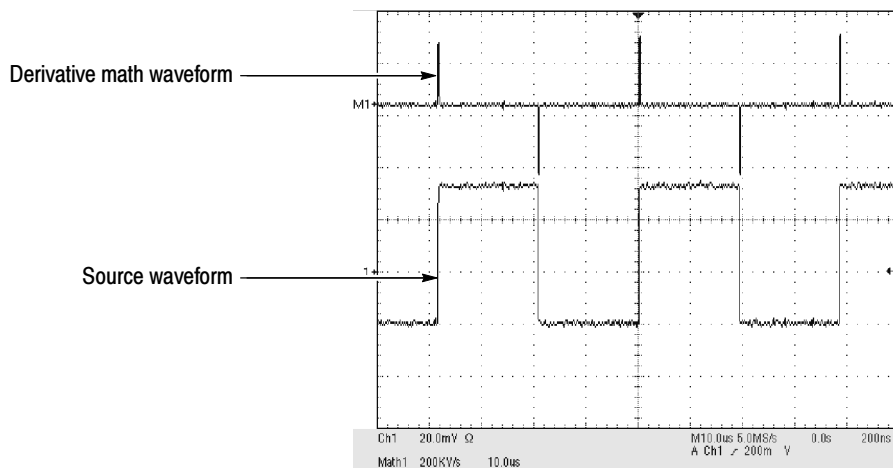

Figure 3- 40: Derivative math waveform

Cursor Measurements. You can also use cursors to measure derivative waveforms. Use the same procedure as is found under *Take Cursor Measurements* on page 3-167. When using that procedure, note that the amplitude measurements on a derivative waveform will be in volts per second rather than in volt-seconds as is indicated for the integral waveform measured in the procedure.

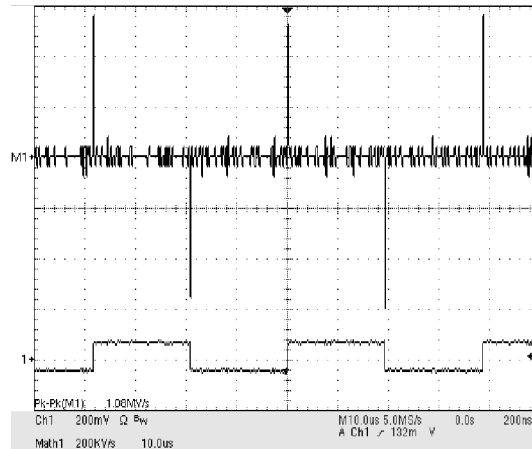

Figure 3-41: Peak-peak amplitude measurement of a derivative waveform

Offset, Position, and Scale. The settings you make for offset, scale, and position affect the math waveform you obtain. Note the following tips for obtaining a good display:

- You should scale and position the source waveform so it is contained on screen. (Off screen waveforms may be clipped, resulting in errors in the derivative waveform).
- You can use vertical position and vertical offset to position your *source* waveform. The vertical position and vertical offset will not affect your derivative waveform unless you position the source waveform off screen so it is clipped.

Waveform Integration. The Math capabilities of the oscilloscope include *waveform integration*. This allows you to display an integral math waveform that is an integrated version of the acquired waveform.

Integral waveforms find use in the following applications:

- Measuring power and energy, such as in switching power supplies
- Characterizing mechanical transducers, as when integrating the output of an accelerometer to obtain velocity

The integral math waveform, derived from the sampled waveform, is computed based on the following equation:

$$y(n) = scale \sum_{i=1}^n \frac{x(i) + x(i-1)}{2} T$$

Where:

- x(i) is the source waveform
- y(n) is a point in the integral math waveform
- scale is the output scale factor
- T is the time between samples

Since the resultant math waveform is an integral waveform, its vertical scale is in volt-seconds (its horizontal scale is in seconds). The source signal is integrated over its entire record length; therefore, the math waveform record length equals that of the source waveform.





Offset and Position. When creating integrated math waveforms from live channel waveforms, consider the following topics:

- You should scale and position the source waveform so it is contained on screen. (Off screen waveforms may be clipped, which will result in errors in the integral waveform).
- You can use vertical position and vertical offset to position your source waveform. The vertical position and vertical offset will not affect your integral waveform unless you position the source waveform off screen so it is clipped.

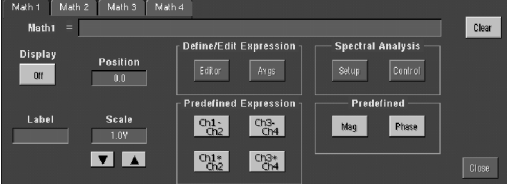

DC Offset. The source waveforms that you connect to the oscilloscope often have a DC offset component. The oscilloscope integrates this offset along with the time varying portions of your waveform. Even a few divisions of offset in the source waveform may be enough to ensure that the integral waveform saturates (clips), especially with long record lengths.

To Define a Math Waveform

Use the procedure that follows when defining a math waveform. Remember, you should first ensure that the sources you use exist. Acquisitions should be running or the channels should already be on, and reference waveform sources should contain saved waveforms, and so on. These sources do not have to be displayed to be used.

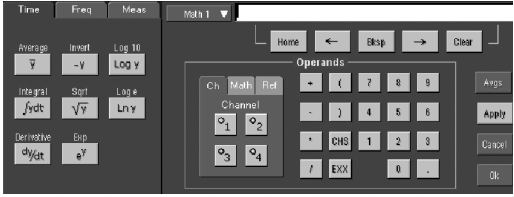
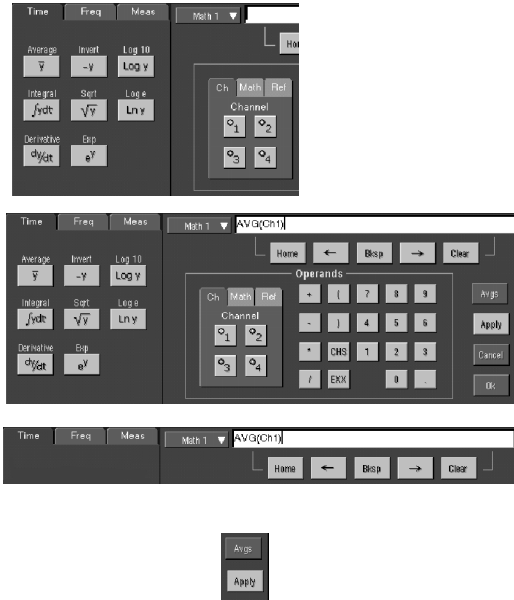
Overview	To define a math waveform	Related control elements & resources
<p>Prerequisites</p>	<p>1. All channel and reference Waveforms and automatic measurement scalars that you will use in your math waveform must be available (channels and references contain data, measurement scalars are defined, and so on.)</p>	 <p>See page 3-27 for acquisition setup & page 3-53 for trigger setup.</p>
<p>Display the math control window</p>	<p>2. From the tool bar, touch the Math button to display the Define Math control window.</p>	
<p>Select a math waveform</p>	<p>3. Select the Math(x) tab for the math waveform you want to define. Be sure to touch Display to toggle it on, so that the waveform displays.</p> <p>Tip. If the waveform you select already exists, its math expression appears in the window. You can still use the waveform by touching the Clear button, which discards its previous math expression. Or repeat step 3 to select another waveform.</p>	
<p>To define an expression</p>	<p>4. Touch one of the Predefined Expression buttons to use a predefined math expression, or touch Editor to Define/Edit a new math expression.</p>	

Overview	To define a math waveform	Related control elements & resources
<p>To define/edit a math expression</p>	<p>5. Use the control window at right to define a math expression. See Table 3-11 on page 3-156 for expression examples; some guidelines for creating your expression follow:</p> <ul style="list-style-type: none"> ■ Sources — Ch1 - Ch4, Ref1 - Ref4, and Meas1 - Meas8 — should be set up before you use them (channels acquired or acquisitions running, references and automated measurement scalars defined). ■ Math definitions are not implemented if sources or other elements of the definition are not valid. ■ Use the backspace button to remove the last entry; use the clear key to remove the entire expression and start over. ■ Use parentheses to group terms in the expression to control execution order, e.g. 5(Ch1 + Ch2). 	
<p>Select a function</p>	<p>6. Select the Time, Freq, or Meas tabs to display the available functions.</p> <p>7. Touch a function button to enter the function in the math expression. Select an operand for the function to operate on.</p> <p>8. Use the Home and arrow buttons to move within the math expression. Use the Bksp (backspace) button to delete portions of the expression.</p> <p>9. Touch Apply to apply your new math expression to the math waveform.</p>	

Overview	To define a math waveform	Related control elements & resources
<p>Apply averaging</p>	<p>10. Touch Avgs to display the Math Averaging control window. The controls in the window apply to the math waveform defined by the expression.</p> <p>11. Select one of the Math(x) n = controls and set the number of averages using the multipurpose knobs or keypad. This number of averages affect math waveforms if the Avg() function is used.</p> <p>12. Touch Close to close the window, touch Editor to open the Define/Edit Expression window, touch Setup to open the math control window, or touch Spect to open the Spectral control window</p>	
<p>Finished</p>	<p>13. Once you have defined the math expression to your satisfaction, click the the apply button. Then click on the OK button to dismiss the dialog box. See <i>To Use Math Waveforms</i> on page 3-164 for more procedures.</p>	
<p>For further assistance</p>	<p>14. Touch the Help button in the tool bar to access context-sensitive help on math waveforms.</p>	 <p>See <i>Accessing Online Help</i> on page 3-245 for overview of the online help system.</p>

Operations on Math Waveforms

This oscilloscope supports many of the same operations for math waveforms that it provides for channel (live) and reference waveforms. For example, you can measure math waveforms with cursors. This section introduces these operations.

- Vertical display scaling and positioning
- Taking automatic measurements
- Taking cursor measurements
- Histograms on math waveforms

Many of the same oscilloscope tools that prove to be powerful adjuncts for displaying, processing, and analyzing other waveforms also work on math waveforms. For example, in addition to the operations listed above, you can save math waveforms as references.

Independent horizontal scaling. Each math waveform that you create derives its horizontal scale and position from the sources you include in its math expression. You can adjust these controls for the source waveforms and your adjustments will reflect in the math waveform as the sources update. You can also magnify all waveforms, including math waveforms, using zoom.

Using Math Waveforms

Basically, you use the same techniques to work with math waveforms that work with channel waveforms.



Consider the Source. In general, be aware that changes to source waveforms that you include as math-expression operands are reflected in the math waveform. However, if Ch1 is 4 divisions high at 100 mV per division, then at 50 mV per division Ch1 is 8 divisions high. Any math using Ch1 will not be affected by this change because the Ch1 voltage levels have not changed. See *Source Dependencies* on page 3-156.

How to manage displaying. Turn on and off the display of math waveforms from the Math control window. Use the same control-window controls (waveform selection buttons, vertical position and scale knobs). Mouse operations for positioning waveforms on screen work also.



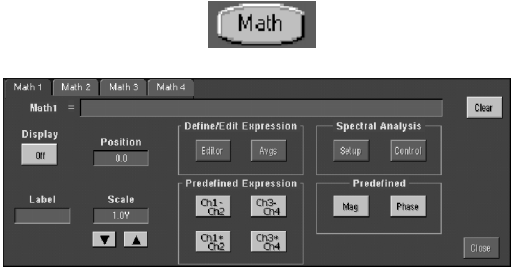

To Use Math Waveforms

The procedure that follows demonstrates some common operations you can perform on math waveforms:

Overview	To use math waveforms	Related control elements & resources
<p>Prerequisites</p>	<p>1. The Math waveform must be defined and displayed. See the reference listed at right.</p>	<div style="text-align: center;">  <p>See To Define Math Waveforms on page 3-160</p> </div>

Overview	To use math waveforms	Related control elements & resources
<p>Select and display</p>	<p>2. Touch the Math button to display the Math control window.</p> <p>3. Touch any Math(x) tab to make that math waveform the selected waveform.</p> <ul style="list-style-type: none"> ■ If the waveform you select is not defined, use the <i>To Define a Math Waveform</i> procedure starting on page 3-160 to define the math waveform. ■ If the waveform is not displayed, touch Display to toggle it on. 	
<p>Set scale and position</p>	<p>4. Touch Position or Scale and use the multipurpose knobs or keypad to size and position the waveform on screen as you want it.</p> <p>Note: <i>Position is in divisions, so changing the scale can make the math waveform disappear until position is also changed (the same effect happens with channel waveforms).</i></p> <p>Tip. You can touch and drag a waveform handle to change the waveform vertical position.</p> <p>Tip. You can adjust the waveform vertical position and scale by first touching the waveform handle and then using the multipurpose knobs to adjust the scale and position.</p> <p>Tip. You can not adjust the offset of a math waveform.</p> <p>Tip. You can not adjust horizontal scale, position, and sample density (resolution) of math waveforms; different length source waveforms result in a math waveform of the shortest source record length. If you adjust these settings for sources for a math waveform, the adjustment is reflected in the math waveform.</p>	

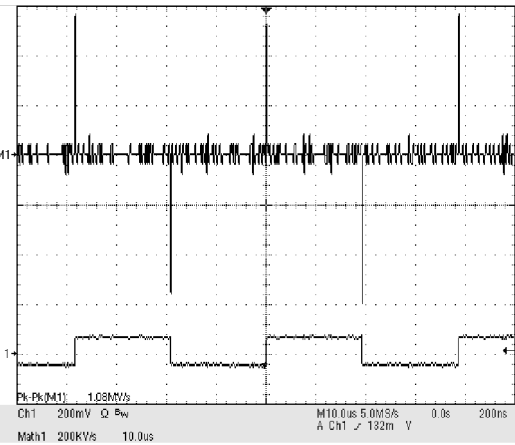
Overview	To use math waveforms	Related control elements & resources
<p>Take automatic measurements</p>	<p>5. Touch the Meas button, select the Math tab, and touch a channel button to choose a math waveform from Math1 - Math4. (See right.)</p> <p>6. Select a measurement (for more information, see <i>Taking Automatic Measurements</i> on page 3-122).</p> <p>Tip. Click the Help button in the menu bar for more information.</p> <p>7. To display the measurement, touch Display to toggle it to on.</p> <p>8. Read the results in the measurements readout.</p>	

Overview	To use math waveforms	Related control elements & resources
<p>Take cursor measurements</p>	<p>You can also use cursors to measure math waveforms. Use the same procedure as is found under <i>To Take Cursor Measurements</i> on page 3-167.</p> <ol style="list-style-type: none"> 9. From the tool bar, touch the Cursor button to display the cursors and the cursor control window. 10. Select the Math tab and touch the numbered button for the math waveform you want to measure. 11. Select the cursor type by touching either the H Bars, V Bars, Paired, or Split buttons (for more information, see <i>Taking Cursor Measurements</i> starting on page 3-132): 12. Turn the multipurpose knobs to position each cursor on the math waveform to measure the feature that interests you. 13. Read the results in the cursor readout. The cursor readout is displayed under the multipurpose readouts or in the upper right corner of the graticule area. <p>Note that amplitude measurements on a derivative waveform are in volts per second and volt-seconds for an integral waveform measurement.</p>	  
<p>For further assistance</p>	<ol style="list-style-type: none"> 14. Touch the Help button in the tool bar to access context-sensitive help on math waveforms, or see <i>Measuring Waveforms</i> on page 3-121. 	 <p>See <i>Accessing Online Help</i> on page 3-245 for overview of the online help system.</p>

Defining Spectral Math Waveforms

The math capabilities of the oscilloscope include spectrum analysis of a waveform. This section describes a spectral analyzer that allows you to control the analysis intuitively with time domain and frequency domain controls. These controls merge the time domain controls with the frequency domain controls to provide a complete spectral analyzer.

Signals may be represented by their characteristics in both the time and the frequency domain. By combining and transforming source waveforms into spectral math waveforms, you can simultaneously view signal characteristics in both domains.

This spectral analyzer provides a complete set of controls and features that allow you to make time and frequency domain measurements without the need to learn extensive details about FFT algorithms.

- **Frequency Domain Controls:** You can operate the spectral analyzer using traditional spectrum analyzer controls. You can set the center frequency, span, and resolution bandwidth directly.
- **Time Domain Controls:** The spectral analyzer has time domain controls for the acquired waveform. These controls set the time duration and the resolution time between samples. You can easily set the required sample rate and record length.
- **Gating Controls:** These controls are the bridge that connect the time domain to the frequency domain. You can perform spectral analysis on a gated region of the input waveform. This gating also determines the resolution bandwidth of the analyzer.
- **Window Functions:** There are eight different window functions that shape the filter response of the spectral analyzer.
- **Magnitude Versus Frequency:** You may choose to display log data in dB or linear mode. You may display the real or imaginary parts of the spectral magnitude only. Ref level offset and reference level controls give complete control over the vertical position and offset of the spectrum. The log zero db ref level may be dialed in manually or set to dBm with a single button touch.
- **Phase Versus Frequency:** You may display phase data as a function of frequency in radians or degrees. You may zero the noise phase for magnitudes below a threshold level. Finally, you may select Phase unwrap and $d\theta/d\omega$, group delay.
- **Spectral Averaging:** You may turn on averaging in the frequency domain for phase and magnitude waveforms.

- **Multiple analyzer control locks:** Up to four spectral analyzers may be used simultaneously. They may all be assigned to different gates on the same source waveform or to different channel sources. The controls of Math1 and Math2 may be locked and the controls of Math3 and Math4 may be locked. that is, turning a control on one analyzer changes the control on the other analyzer to the same value. Other combinations of locking, including all four analyzers, are available using GPIB commands.

The same exclusions for math waveforms apply to spectral math waveforms. In addition, sources for spectral math waveforms must be channel waveforms.

Using Spectral Math Controls

Read the following topics; they provide details that can help you create the spectral waveform that best supports your data-analysis tasks.

The spectral analyzer contains five primary control categories. These are shown in Table 3-12.

Table 3-12: Spectral analyzer controls

Time controls	Gate controls	Frequency controls	Magnitude controls	Phase controls
Source	Position	Center	dB, dBm linear, real imaginary	degrees, radians, group delay
Duration, record length	Duration	Span	Ref level	Zero threshold
Duration, sample rate	Window	Resolution bandwidth	Ref level offset	Phase Unwrap
Resolution				

Using the time controls. The operation of the time domain controls for the spectral analyzer is summarized by the following rules:

- Duration selects the time from the beginning to the end of the acquired waveform. You may set duration using the record length control or the sample rate control.
- Resolution determines the time between samples. Duration is kept constant as resolution is changed. Therefore, the Resolution control affects both the sample rate and the record length simultaneously.
- Most often, you will want to use a short record length because long record lengths can slow oscilloscope response. However, long record lengths lower the noise relative to the signal and increase the frequency resolution for the spectral math waveform. More important, they might be needed to capture the waveform feature you want to include in the waveform.

Examples of how duration and resolution affect the acquired waveform are shown in Figure 3-42.

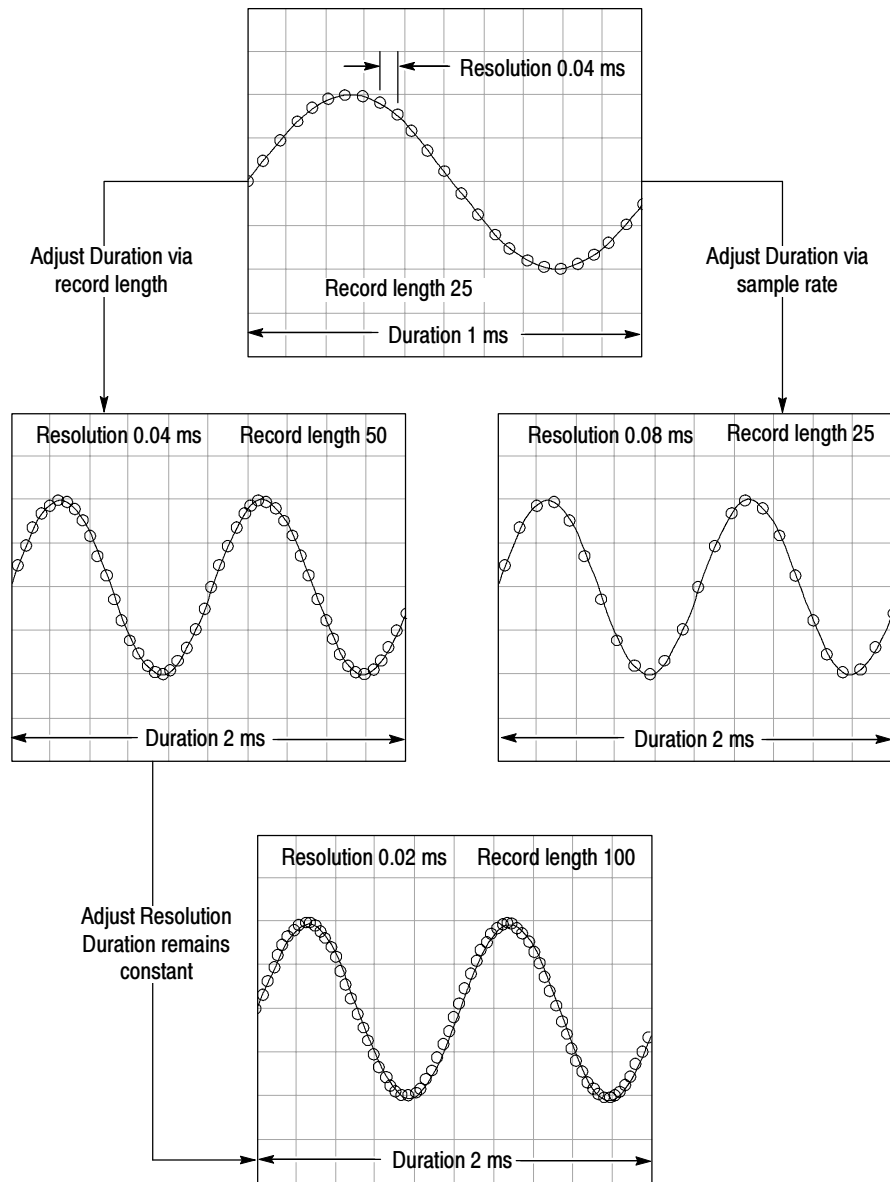

Figure 3-42: Duration and resolution control effects

Using the gate controls. Gating determines what portion of the acquired waveform is transformed into the frequency domain. The gate has a position and a width control.

The gate position is the time in seconds from the trigger location to the center 50% position of the gate interval (see Figure 3-43). The position and width units are seconds.

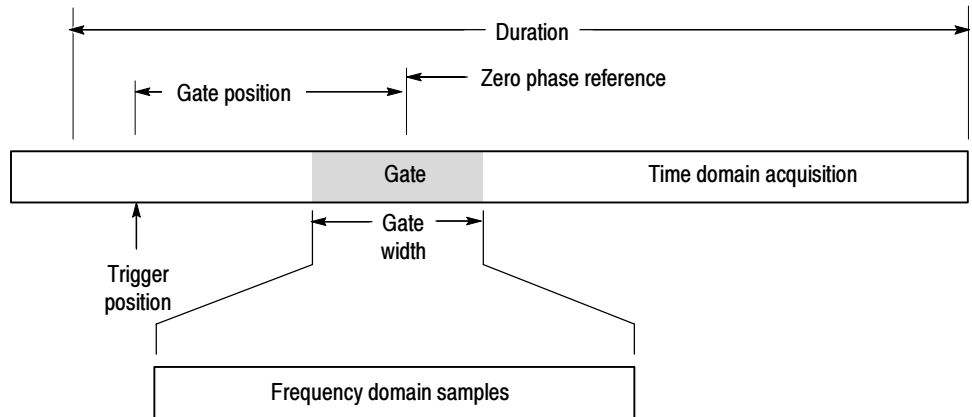

Figure 3-43: Definition of gate parameters

The gate must reside within the duration interval of the source waveform. If the source waveform duration is adjusted and the gate position and width would result in the gate being outside of that duration then the gate position or width is set within the limits.

The width of the gate affects the resolution bandwidth of the spectral analyzer. See *Using Spectral Math Controls* on page 3-169 for more details.

The data contained in the gated region is transformed to the frequency domain.

The gate is identified on the display using dashed markers (similar to cursors). The default gate width setting is equal to the duration of the source waveform.

Using the Frequency Domain controls. The gated region of the source waveform is transformed by the spectral analyzer to a spectral waveform. This may be a phase or magnitude waveform. The horizontal units are always Hz. The vertical units depend on whether phase or magnitude is selected. The frequency domain controls for the spectral waveform are span, center, and resolution bandwidth. The spectrum normally appears on the display fit to a screen width of 10 divisions.

Span: The span is the stop frequency at the end of the spectral waveform minus the start frequency at the beginning of the waveform. The span control maximum value is equal to the current sample rate divided by two. Therefore, if you are unable to increase the span to the desired value and if you want to keep the same source waveform duration, go to the timebase controls and increase the sample rate using the resolution control. Or, if you want to also decrease the source waveform duration, adjust the sample rate control. If you decrease the sample rate, the span setting may decrease, if necessary, to keep the span less than the sample rate divided by two.

Center: This is the frequency at the center of the spectral waveform. Center is equal to the start frequency plus one half of the span. The adjustment range depends on the sample rate and the current span setting. Remember that the span must always be in the interval of zero to one half of the sample rate. Where one end of the span goes to DC or Nyquist, depending on which direction the center frequency is adjusted, the span decreases to allow the center frequency to go further in the direction it is being adjusted. If you are unable to increase the center to the desired value then increase the sample rate using either the sample rate or resolution controls. You may also change sample rate by using the HORIZONTAL SCALE knob on the oscilloscope front panel.

Resolution Bandwidth, RBW: This is the 3 dB down bandwidth of the spectral analyzer frequency response to a sine wave input. The resolution bandwidth is affected by two parameters.

- Different window functions produce different filter response shapes in the spectrum and result in different resolution bandwidths.
- The gate width, of the input data, affects the resolution bandwidth (RBW). Gate width has units of seconds. The resolution bandwidth directly controls the gate width, but the numerical value is entered in units of Hz. Therefore, the time domain gate markers move as you adjust the RBW control.

$$RBW = \frac{\text{Window Bin Width}}{\text{Gate Width}}$$

Where the Window Bin Width is the resolution bandwidth in units of bins. It depends on what window function in use. The gate width is in units of seconds.

Figure 3-44 demonstrate the affects of adjusting center frequency and span. Center frequency is a horizontal position control for the spectrum. Span is a horizontal scale control. Resolution bandwidth usually adjusts the bandwidth of the analyzer filters without affecting the span and center frequency.

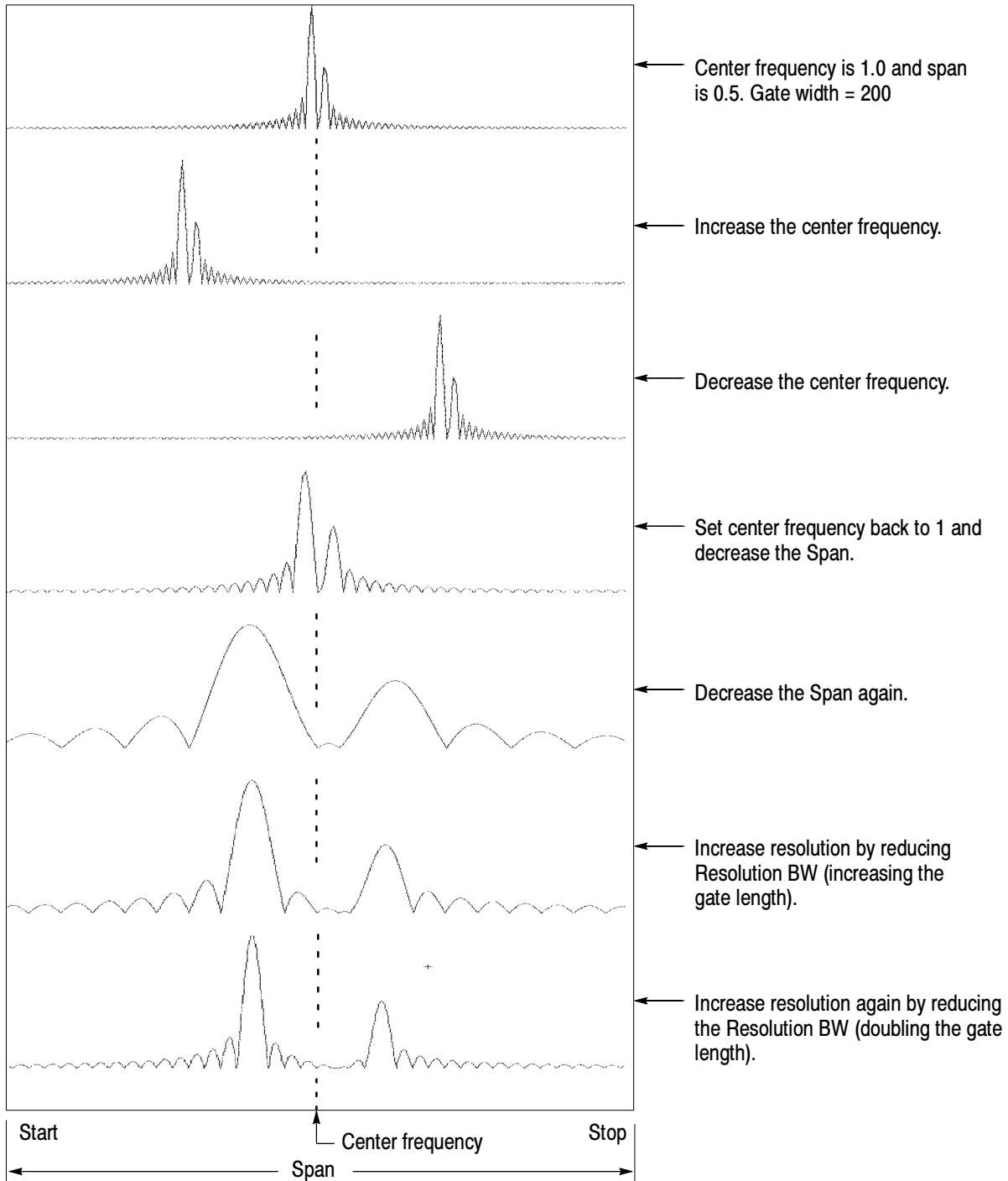

Figure 3-44: Affects of frequency domain control adjustments

Using the magnitude controls. Vertical units can be either linear or log. You may select these choices by touching Math menu button. Then touch the Spectral Analysis Setup button. Then select the Mag tab. Then select the desired scale type from Linear, dB, or dBm.

Linear: When the spectrum is linear magnitude the vertical units are the same as the source waveform. Usually this is volts. However, it may also be watts or amperes.

dB: This sets the vertical scale of the magnitude spectrum to dB. Use the Reference Level Offset to set what vertical position in the magnitude spectrum will be zero dB. The following equation applies:

$$dB = 20 \log\left(\frac{|X|}{Ref}\right)$$

If the input units are watts, the the following equation applies:

$$dB = 10 \log\left(\frac{|X|}{Ref}\right)$$

Where X is a complex data point in the spectrum and Ref is the Reference-Level Offset value.

dBm: This selects dB as described in the above equation, but it also sets the Reference-Level Offset to a value that is equivalent to 1 mW of power into 50 ohms. Therefore, if the input units are volts, then the value is set to 223.6 mV. If the input units are amperes, then the value is set to 40 μA. If the input units are watts, then the value is set to 1 mW.

Reference Level: This sets the vertical position of the displayed spectrum. Its value is the magnitude at the top of the display screen. When this control is adjusted, the spectral waveform along with its zero reference marker move vertically on the screen (see Figure 3-45). This control does not change the spectral data.

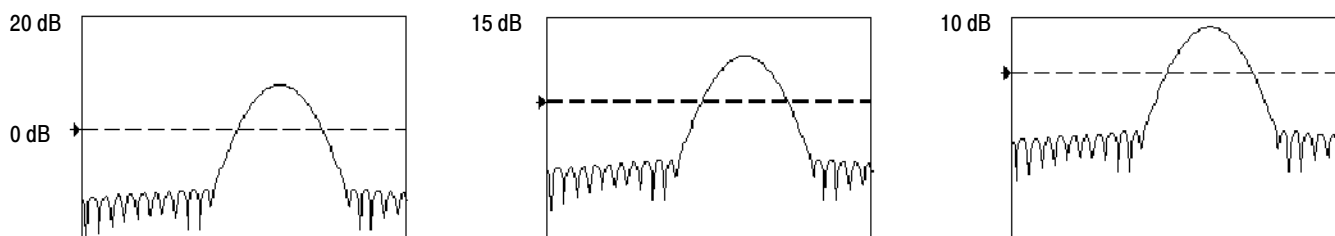

Figure 3-45: Effects of adjusting the reference level

Reference Level Offset: This changes the value of Ref in the equation for dB shown above. Unlike the Reference Level control, this control actually changes the output data values in the spectrum. Zero dB is shown on the display screen by the marker associated with the spectral waveform. Adjusting the reference-level offset causes the spectral waveform to move vertically with respect to the waveform reference marker. This moves the waveform without changing the Reference-Level control setting. Sometimes it is beneficial to adjust this control so that the peak of a fundamental is at zero dB. Then you can measure other harmonics in terms of how many dB they are down from the fundamental. Touch the dBm button to preset this level to the equivalent of 1 mW into 50 ohms.

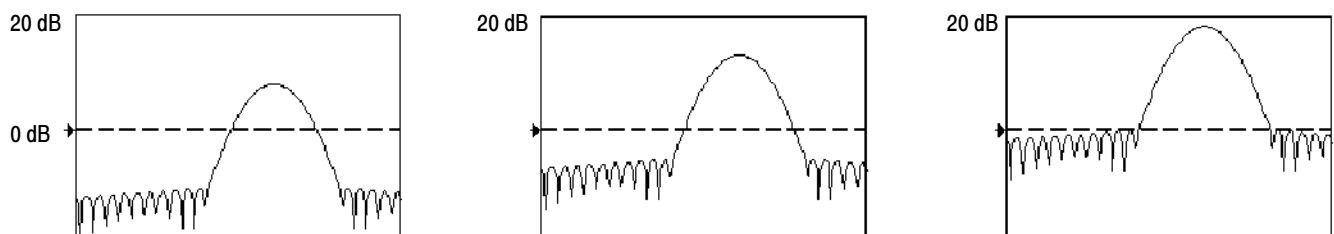

Figure 3-46: Effects of adjusting the reference level offset control

Real and Imaginary Magnitudes: You may set the spectral analyzer to display the linear magnitude of the real data or the imaginary data in the spectrum.

This is useful if you process the spectrum off line and transform it back into a time domain trace. You could save the real and the imaginary spectrum into a reference memory. You can export the waveforms directly into Mathcad, Matlab, and Excel documents and update in real time.

To turn on a real or imaginary spectrum, first touch the Math button, then the Define/Edit Expression Editor button, and then select the Freq tab. Then touch either the Real or the Imag menu items to enter an expression. Then touch the Ch tab and one of the channel buttons. Then touch apply.

Using the Phase Controls. You can set the vertical units to degrees, radians, or seconds of group delay. You select these choices by touching the Math button, the Spectral Analysis Setup button, and then selecting the Phase tab. Then select the desired scale type from Degrees, Radians, or Group Delay.

Phase Reference Position: Phase is a relative measurement that must have a time domain reference point. The phase value is specified with respect to this phase reference position.

For the spectral analyzer, the phase reference position is the 50% position of the gate, that is, the middle of the gate interval of the data that is input to the spectral

analyzer. This is true for all window functions except for the Tek Exponential window. This window has the reference point at the 20% position of the gate.

Phase Unwrap: The spectral analyzer produces phase values from $-\pi$ to π radians or -180 to 180 degrees. However, when you perform impulse response testing and the phase is continuous, then phase values outside these ranges may occur. The spectral analyzer then wraps the data with discontinuities in the display from $+180$ to -180 degrees. Phase unwrap will display the correct result by unwrapping the phase.

Phase unwrap is only valid when the phase spectrum is a continuous function of frequency. Therefore, do not use it when analyzing the harmonic content of the typical repetitive signal.

Suppression Threshold: Random noise in the spectrum may have phase values over the entire range. This could make the phase display unusable. However, you can set the suppression threshold control to a level in dB. The phase of any complex spectral points with a magnitude below this threshold is set to zero.

Phase Unwrap Algorithm. The algorithm searches for the largest magnitude in the current span. Phase unwrap is then performed in both directions in frequency from that point. This results in a stable phase unwrap.

Phase Spectrum dejitter. An instrument acquisition system jitters by one sample interval. Signals at the Nyquist frequency only have two samples per cycle. This would cause 180° of phase jitter if it were not corrected. The instrument phase spectrum is dejittered so that accurate measurements of phase are obtained from DC to the Nyquist frequency.

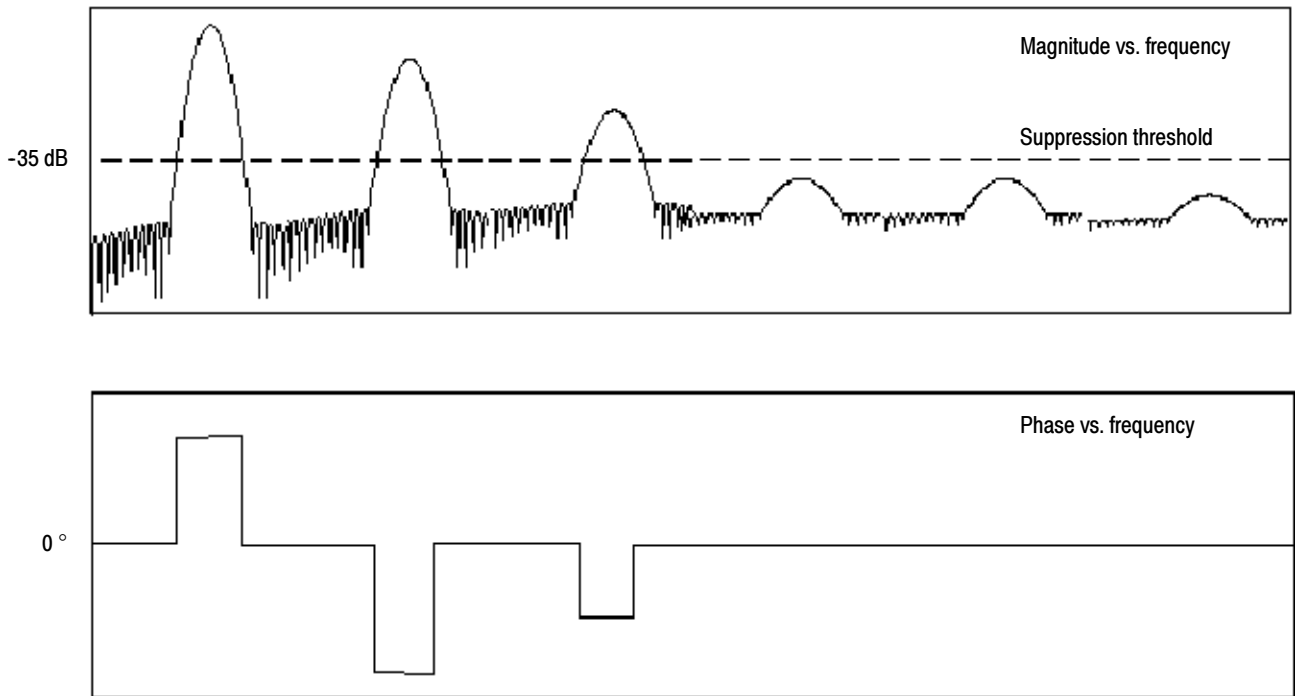

Figure 3-47: Example of the effects of setting the phase suppression threshold

Group Delay: When the phase spectrum is a continuous function of frequency, group delay may be computed. This is true of impulse response testing where an impulse is fed into the system and the spectrum of the response of the system output is computed.

Group delay measures how well a system passes a signal in terms of phase distortion. Group delay is the negative derivative of the phase with respect to frequency.

This feature is not useful for analysis of harmonic content of signals where the phase response is not continuous.

Impulse Response Testing: When performing impulse response testing of a system, place the impulse at the zero-phase reference position of the acquisition. This produces a correct phase display. Because the Tek Exponential window has its zero phase reference position at the 20% point, more of the impulse response is captured. All other window functions have their phase reference position at the 50% position in the gated region.

There are several ways to adjust the position of the zero phase reference point with respect to your input signal:

- Adjust the spectral analyzer gate position

- Perform fine adjustment using the front-panel trigger level control
- Adjust the front-panel HORIZONTAL POSITION control

Using windows to filter. There are eight different spectral analyzer windows:

- Rectangular
- Hamming
- Hanning
- Kaiser-Bessel
- Gaussian
- Blackman-Harris
- Flattop2
- TekExponential

In the time domain a window is a “bell” shaped function equal in length to the gate duration. For most windows this function tapers to zero at both ends of the gate region. Before computation of the spectral transform, the window is multiplied, sample by sample, times the input data in the gate region. The window function affects the shape of the spectral analyzer response in the frequency domain. The window functions affect the ability to resolve frequency in the output spectrum and can affect the accuracy of the magnitude and phase measurements. Figure 3-48 shows how the time domain record is processed.

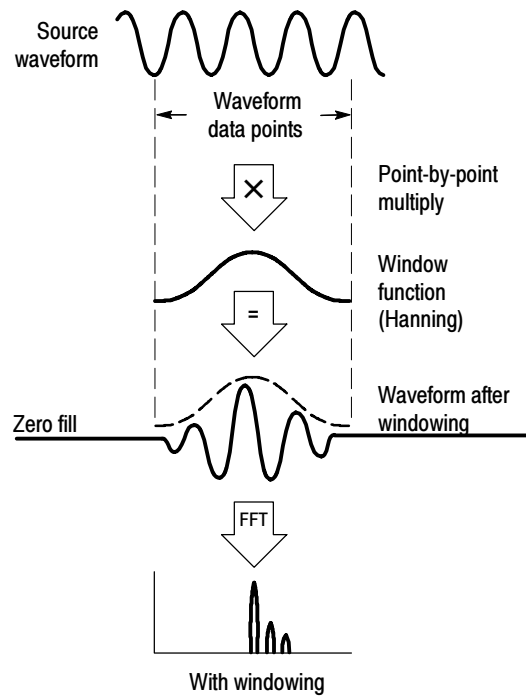

Figure 3-48: Windowing the time domain record

Accurate magnitude measurements require that the input source waveform be stationary within the gate region. This means that waveform parameters such as frequency and amplitude not change significantly as a function of time within the gate region that is input to the spectral analyzer. Also, the gate width must be greater than or equal to the period of the start frequency of the span of the spectral analyzer, that is, there must be at least one cycle of the harmonic being measured within the gate region.

Choice of a window: Your choice of window function will depend on the input source characteristics which you want to observe and the characteristics of the window function. The window characteristics are shown in Table 3-13.

FFT length. The FFT length is controlled so that the gate width in samples is never more than 0.8 of the FFT length. Thus, zero fill is always in effect. This essentially eliminates scallop loss errors in magnitude that would occur without zero fill.

Table 3- 13: Window characteristics

Window	3 dB BW in bins	Scallop loss	Nearest side lobe	Zero phase reference	Coefficients
Rectangular	0.89	3.96 dB	-13 dB	50%	1.0
Hamming	1.3	1.78 dB	-43 dB	50%	0.543478, 0.456522
Hanning	1.44	1.42 dB	-32 dB	50%	0.5, 0.5
Kaiser-Bessel	1.72	1.02 dB	-69 dB	50%	0.40243, 0.49804, 0.09831, 0.00122
Blackman - Harris	1.92	0.81 dB	-92 dB	50%	0.35875, 0.48829, 0.14128, 0.01168
Gaussian	2.0	0.76 dB	-79 dB	50%	a = 3.75 (not cosine series)
Flatop2	3.8	0.0065 dB	-90 dB	50%	0.213348, -0.206985, 0.139512, -0.043084, 0.003745
Tek Exponential	1.42	0.60 dB	-67 dB	20%	na

3 dB BW in Bins: This is the bandwidth of the filter response of the spectral analyzer to a sine wave input for a given window function. It is given in units of bins. A bin is the interval between spectral samples when the interpolation ratio due to FFT zero fill is one. The bandwidth is measured between the points on the lobe that are 3 dB down from the peak of the lobe. The bandwidth in Hz may be computed by dividing the BW in bins by the gate duration in seconds. This is also referred to as resolution bandwidth (RBW).

Coherent gain: The gain factor normally associated with different window functions is correctly scaled into the magnitude spectrum output. Therefore, the magnitudes in the output spectrum do not change as different windows are selected.

Scallop Loss: This is the magnitude error of an FFT when the frequency of the observed signal is exactly half way between two frequency samples of the spectrum when the interpolation ratio due to zero fill of the FFT is one. The spectral analyzer FFT length is controlled so that zero fill is always in effect. This essentially eliminates scallop loss because zero fill in the time domain causes interpolation in the frequency domain. This results in accurate magnitude measurements for all window functions.

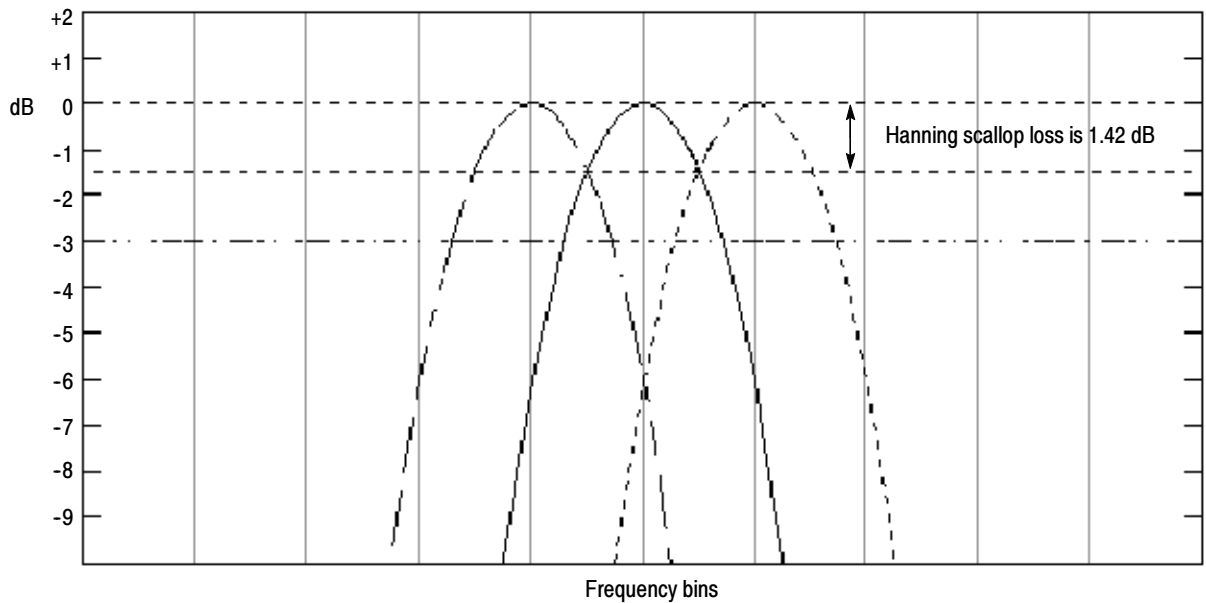

Figure 3-49: Example of scallop loss for a Hanning window without zero fill

Nearest Side Lobe: This is the difference in magnitude between the spectral lobe peak in the spectrum and the next side lobe that occurs due to energy leakage. Different windows have different leakage characteristics. The more narrow the resolution bandwidth of the window the more leakage in the spectrum.

Zero Phase Reference: This is the position in the time domain gate that is the reference point for phase in the output spectrum, that is, if a sine wave input has its peak at the zero phase reference position then it reads out as zero phase in the spectrum. If the phase is to be correct when doing impulse response testing, the impulse in the time domain must be located at this position in the gate interval.

Coefficients: These are used to generate the windows which are constructed from a cosines series. For the Gaussian window the value of 'a' is given instead of a set of coefficients. You can find descriptions of cosine series windows in *Handbook of Digital Signal Processing Engineering Applications* by Elliot. ISBN 0-12-237075-9.

Gaussian Window: This is the default window function (see Figure 3-50). It is unique in that the time-domain shape of an exponential Gaussian function transforms into a Gaussian exponential shape in the frequency domain. This window provides optimal localization in both the time and the frequency domain. This is the filter shape most commonly used in spectrum analyzers.

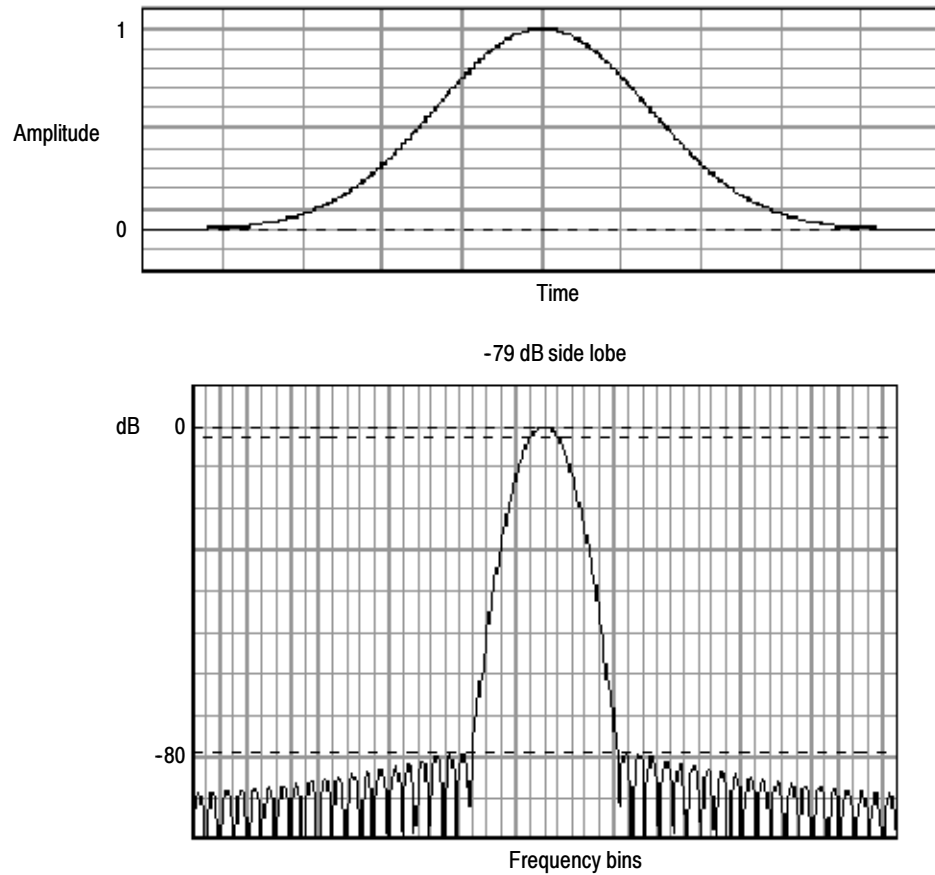

Figure 3- 50: Time and frequency graphs for the Gaussian window

Rectangular Window: This window is equal to unity (see Figure 3-51). This means the data samples in the gate are not modified before input to the spectral analyzer. This window has the narrowest resolution bandwidth of any of the windows, but it also has the most spectral leakage and the highest side lobes.

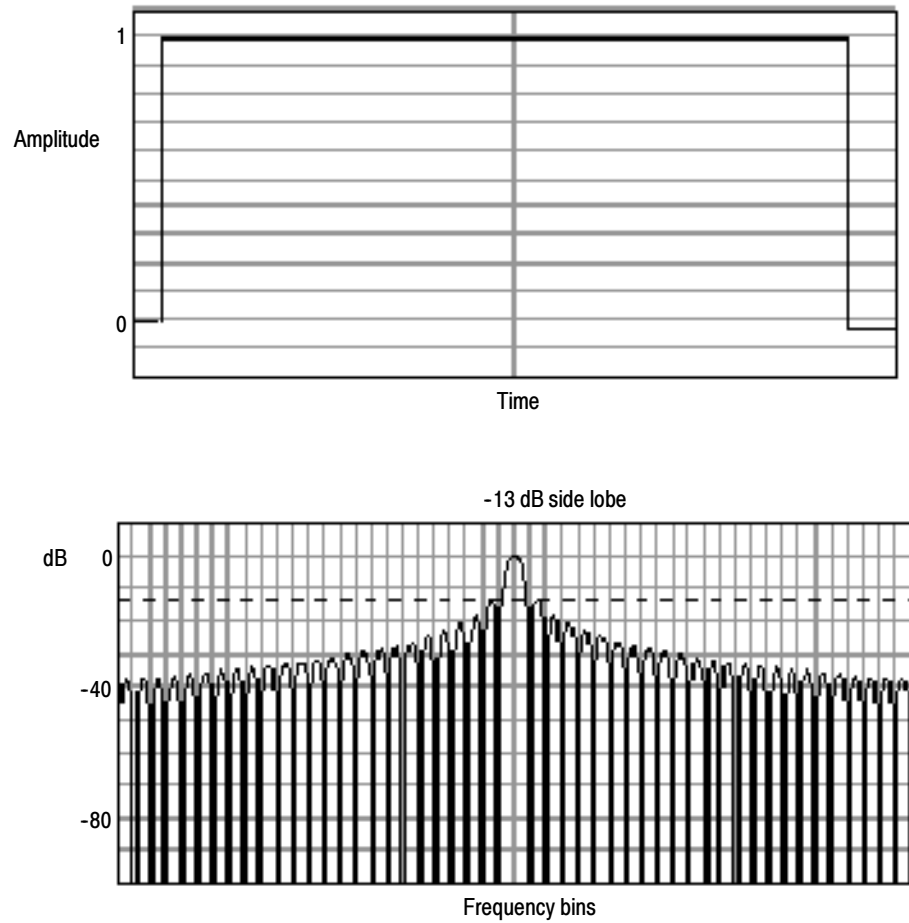

Figure 3-51: Time and frequency domain graphs for the Rectangular window

Hamming Window: This window is unique in that the time domain shape does not taper all the way to zero at the ends. This makes it a good choice if you wanted to process the real and imaginary parts of the spectrum off line and inverse transform it back to the time domain. Because the data does not taper to zero you could then remove the effect of the window function from the result.

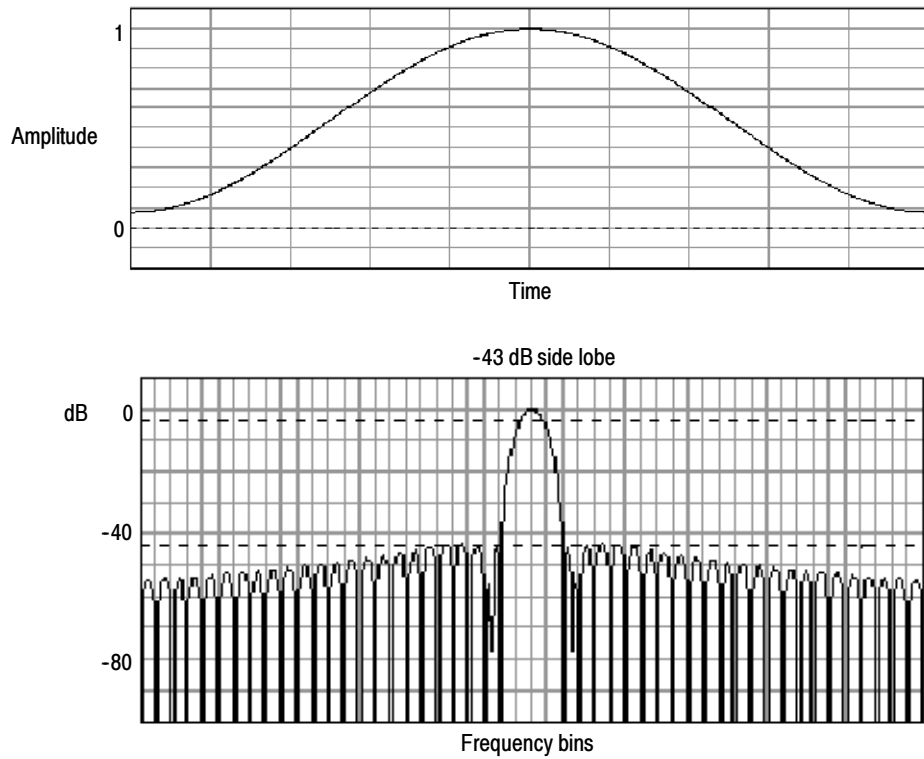

Figure 3- 52: Time and frequency graphs of the Hamming window

Hanning, Kaiser-Bessel, and Blackman-Harris Windows: These windows have various resolution bandwidths and scallop losses (see figures 3-53, 3-54, and 3-55). Choose the one that best allows you to view the signal characteristics you are interested in. The Blackman-Harris has a low amount of energy leakage compared to the other windows. The Hanning has the narrowest resolution bandwidth, but higher side lobes.

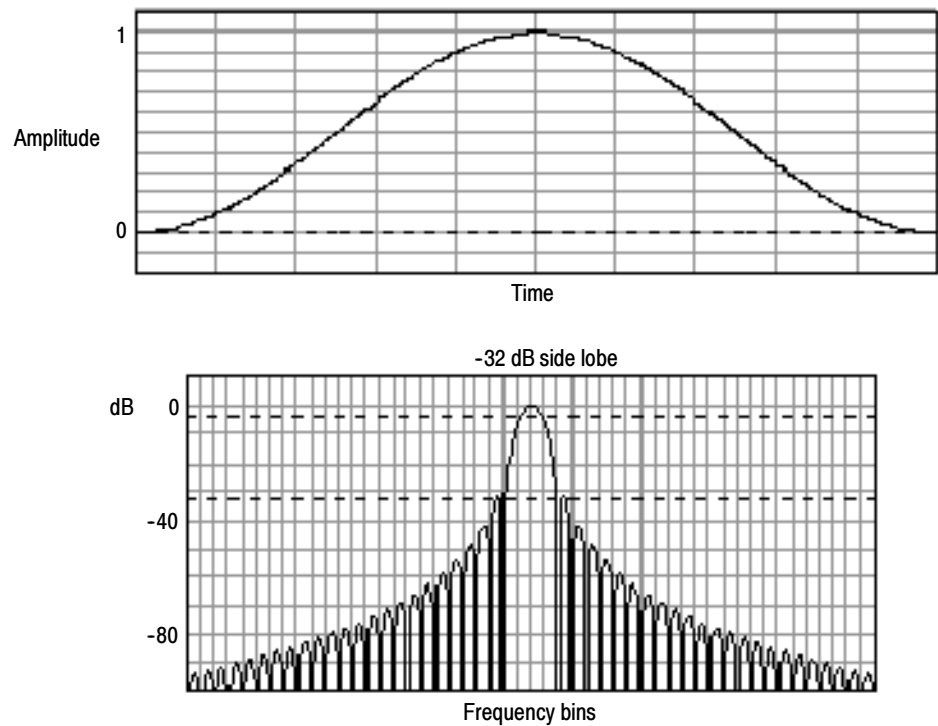

Figure 3-53: Time and frequency graphs for the Hanning window

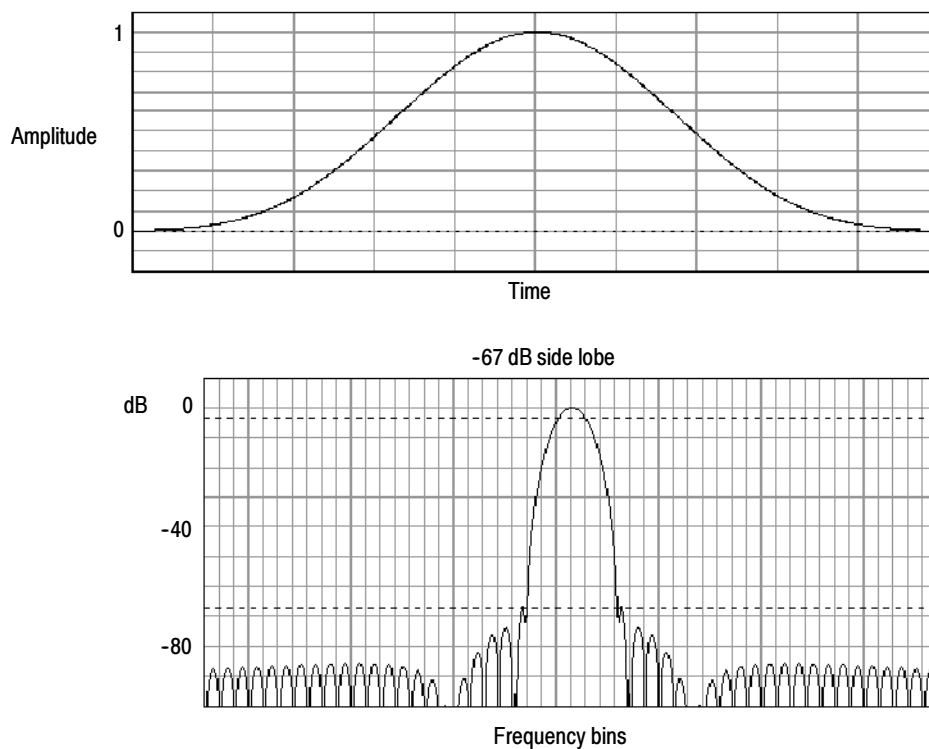

Figure 3- 54: Time and frequency graphs for the Kaiser-Bessel window

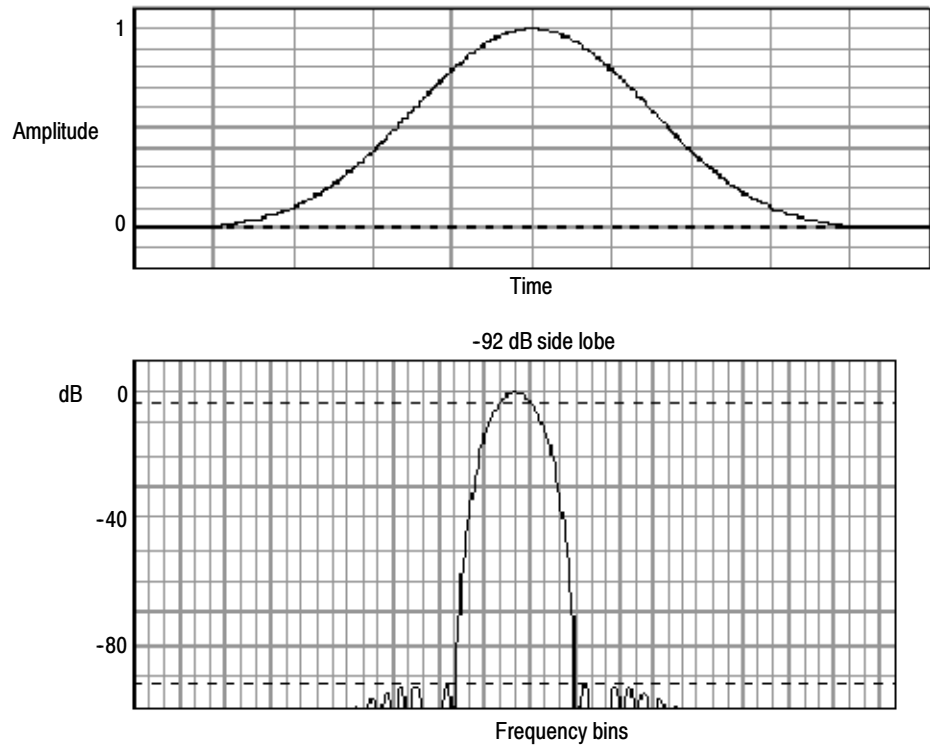

Figure 3-55: Time and frequency graphs of the Blackman-Harris window

Flattop2 Window: This window has the lowest scallop loss of any of the windows. It also has a wider resolution bandwidth but lower side lobe attenuation. Also, it is unique because the time domain shape has negative values.

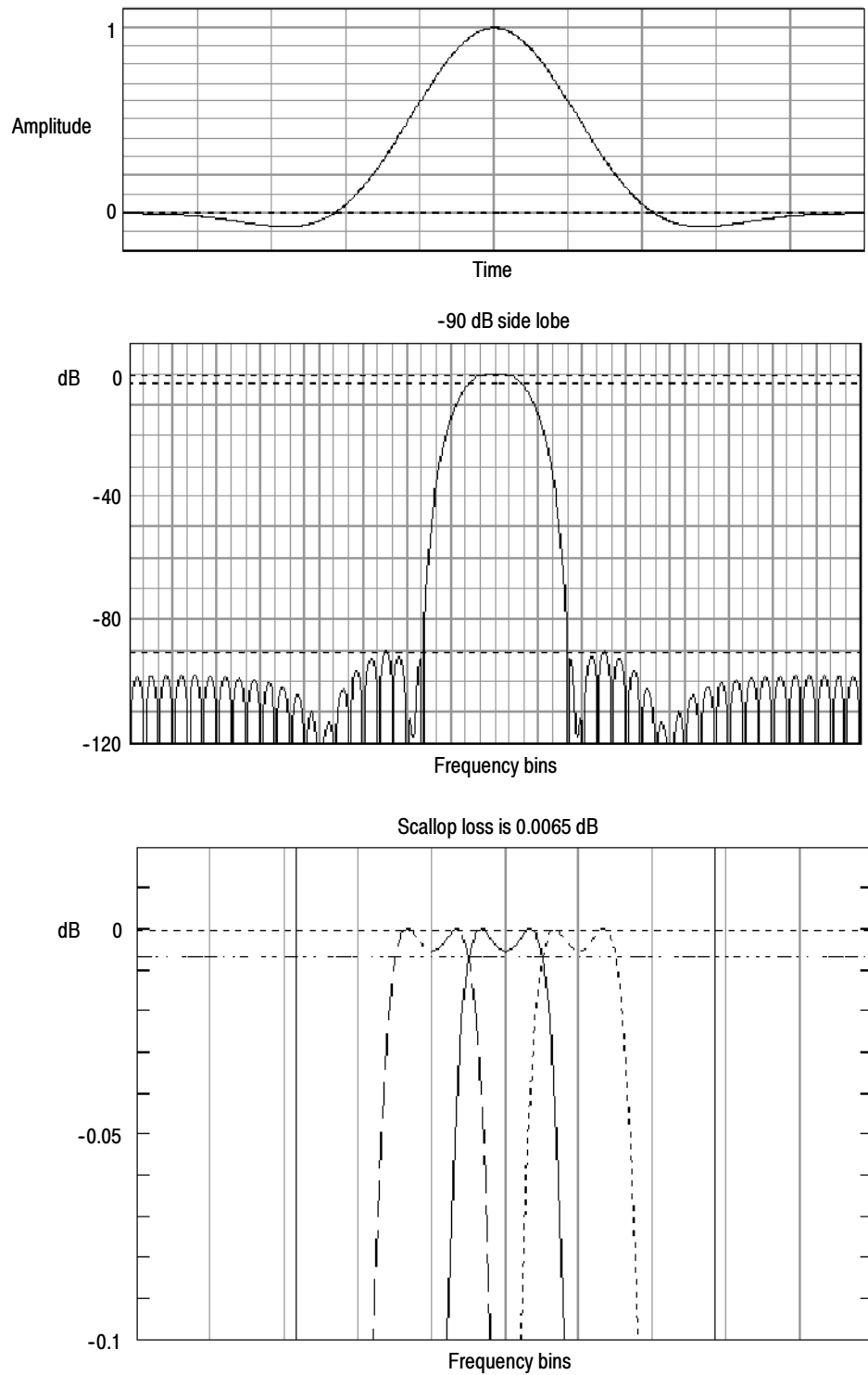

Figure 3- 56: Time and frequency domain graphs for the Flattop2 window

Tek Exponential Window: The Tek Exponential window was invented at Tektronix. In the time domain, it is not a symmetrical bell shape as is the case with the other windows. Instead, it is exponential with a peak at the 20% position of the time domain gate. The frequency domain shape is triangular. Use this window for impulse response testing where the 20% position is the zero phase reference point. More of the acquired data record length is used to capture the impulse response. Exact details of how to compute its values were published in the article, *Impulse-response testing lets a single test do the work of thousands* by John Pickerd in EDN magazine, April 27, 1995, page 95.

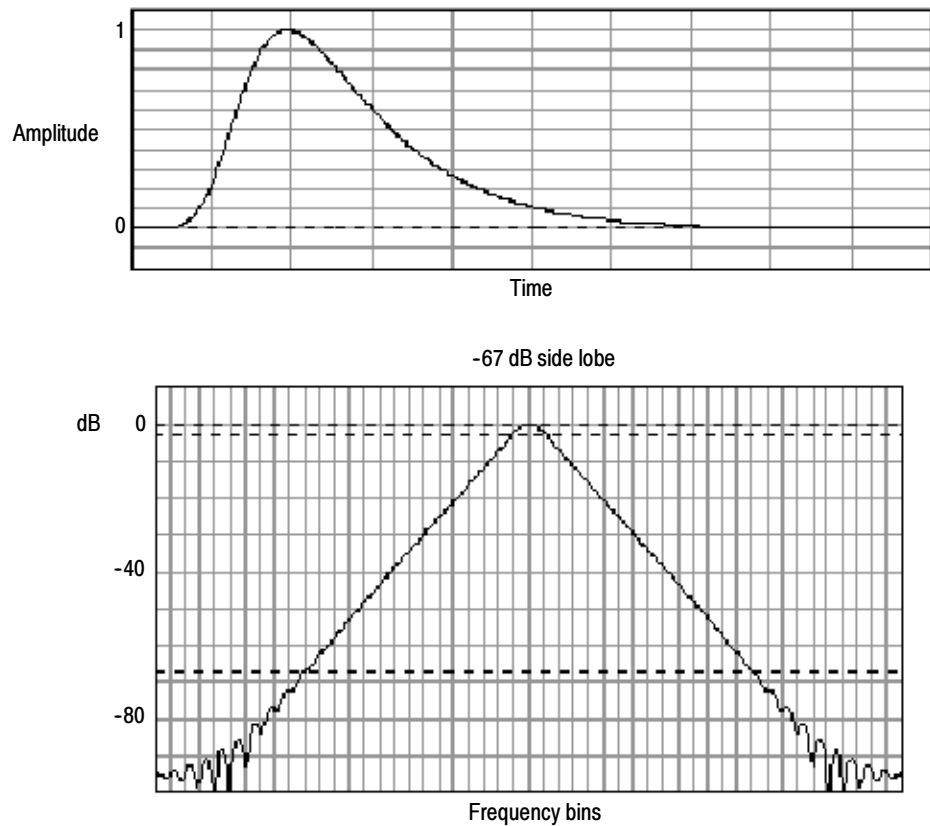

Figure 3-57: Tek Exponential window in the time and the frequency domains

Affects of trigger jitter. The oscilloscope acquisition system has a sample clock that is asynchronous with respect to the input signal. This means that from one acquisition to the next, samples may be in a different position on the waveform with respect to the trigger. Samples may vary in position by up to one sample interval.

There are only two samples per cycle of a signal that have a frequency equal to one half of the sample rate. This is the highest non-aliased signal that can be output from the spectral analyzer. Thus, at this frequency, one sample of acquisition jitter will show up in the spectrum as 180 degree phase variations. The phase spectrum is dejittered by using the fractional trigger value of the instrument to correct all phases in the spectrum. Therefore phase is accurately measured from DC to the Nyquist frequency.

Affects of Average and High Res acquisition modes: The result of averaging the time domain acquisition using either average mode or Hi Res acquisition mode affects the frequency response of the oscilloscope. This is due to the one sample of jitter in the acquisition system. Both High Res and average acquisition modes have the same affect on the frequency response. These modes cause the response to roll off from a magnitude value of one at DC to a magnitude value of 0.63 at Nyquist which is the frequency equal to one half of the sample rate. This is true regardless of the real time sample rate setting.

Frequency Domain Averaging: You may turn on average for a math waveform by editing the math expression. Sometimes it is more desirable to average in the spectrum than in the time domain. For example, consider a signal that has time domain components that are asynchronous to the trigger. If you turn averaging in the time domain, these components may go to zero or produce strange non-deterministic effects on the resultant waveform. Thus, these signal components may end up not appearing in the spectrum. However, if averaging is done in the frequency domain instead, then these components will be present. An example is:

Math1 = AVG(SpectralMag(Ch1)).

Recognizing Aliasing

Aliasing occurs when the input frequency of a signal is greater than one half of the sampling frequency (the sample rate).

Set the sample rate high enough so that the signals in the spectrum appear at their correct frequency as opposed to a lower aliased frequency value. Also, complex signal shapes that have many harmonics in them, such as a triangle or square wave, can appear to be OK in the time domain when in fact many of the harmonics in that signal are aliased.

One way to check for aliasing is to increase the sample rate and observe whether any of the harmonics unwrap to different frequency locations.

Another way to recognize aliasing is to realize that higher order harmonics usually have decreasing magnitudes compared to lower order harmonics. Thus, if you see a series of increasing harmonic magnitude values as frequency increases then you can suspect that they may be aliased. In the spectral math waveform, the actual higher frequency components are undersampled, and therefore, they appear as lower frequency aliases that “fold back” around the Nyquist point. (See

Figure 3-58.) You may test by increasing the sample rate and observing if aliases unwrap to different frequency positions.

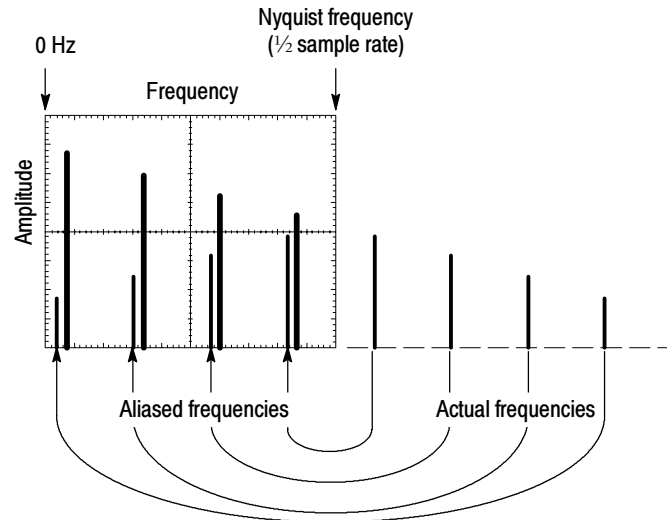

Figure 3-58: How aliased frequencies appear in a spectral waveform

Another way to observe aliasing, if you have a variable frequency signal source, is to adjust the frequency slowly while watching the spectral display. If some of the harmonics are aliased, you will see the harmonics decreasing in frequency when they should be increasing or vice versa.

To Take Cursor Measurements of a Spectral Math Waveform. Once you have displayed a spectral math waveform, use cursors to measure its frequency amplitude or phase angle. Use the procedure *To Take a Cursor Measurement* found in *Taking Cursor Measurements* on page 3-132.

To Take Automated Measurements of a Spectral Math Waveform. You can use automated measurements to measure spectral math waveforms. Use the procedure *To Take Automated Measurements* found in *Taking Automated Measurements* on page 3-122.

Swept Sine Wave Analysis. Many applications of the spectral analyzer require swept sine wave input. The following equations determine what the maximum sweep speed of the sine wave generator should be for a given span and resolution bandwidth.

$$T = \frac{(freq\ span * K)}{RBW^2}$$

T = minimum time to sweep the sine over the requested span



freq span = frequency span of interest

RBW = resolution bandwidth

K = 2 dB BW in bins for the window function in use as shown in Table 3-13 on page 3-180. K = 2 for a Gaussian window.



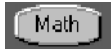

To Select a Predefined Spectral Math Waveform

Use the procedure that follows to select a predefined spectral math waveform. Remember, a channel source should be acquiring or have acquired data. This source does not have to be displayed to be used.



Overview	To select a predefined spectral math waveform	Related control elements & resources
Prerequisites	<ol style="list-style-type: none"> All channel and reference Waveforms and automatic measurement scalars that you will use in your math waveform must be available (channels and references contain data, measurement scalars are defined, and so on.) 	 <p>See page page 3-27 for acquisition setup & page 3-53 for trigger setup.</p>
Display the math control window	<ol style="list-style-type: none"> From the tool bar, touch the Math button to display the Define Math control window. 	
Select a predefined spectral analysis math waveform	<ol style="list-style-type: none"> Touch Mag or Phase to select a predefined magnitude or phase spectral analysis waveform. Selecting a predefined spectral waveform turns on display of the waveform. 	



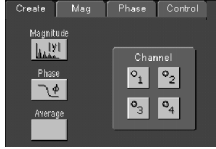
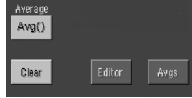

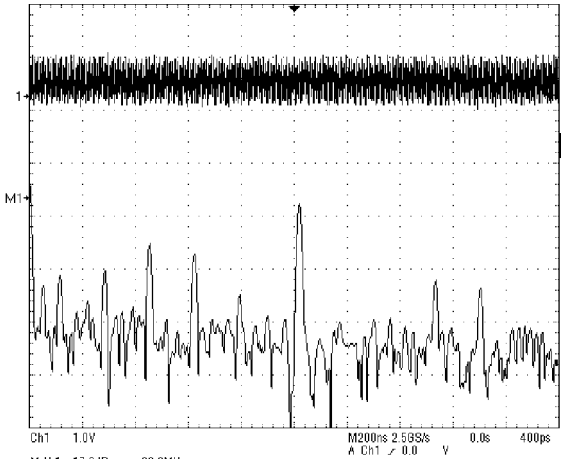
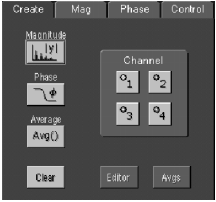
To Define a Spectral Math Waveform

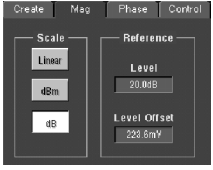
Use the procedure that follows when defining a spectral math waveform. Remember, you should first ensure that the sources you use exist. Channel sources should be acquiring or have acquired data. These sources do not have to be displayed to be used.

Overview	To define a spectral math waveform	Related control elements & resources
<p>Prerequisites</p>	<p>1. All channel and reference Waveforms and automatic measurement scalars that you will use in your math waveform must be available (channels and references contain data, measurement scalars are defined, and so on.)</p>	 <p>See page 3-27 for acquisition setup & page 3-53 for trigger setup.</p>
<p>Display the math control window</p>	<p>2. From the tool bar, touch the Math button to display the Define Math control window.</p>	
<p>Select spectral analysis setup</p>	<p>3. Touch Spectral Analysis Setup and then select the Create tab to display the Spectral Analysis Setup control window.</p>	
<p>Select a spectral waveform</p>	<p>4. Touch Math(x) and select the math waveform you want to create from the list.</p> <p>5. Touch Magnitude to create a magnitude spectral waveform or touch Phase to create a phase spectral waveform.</p> <p>6. Touch the channel number that contains input data for the spectral analyzer.</p> <p>7. If you want an averaged spectral waveform, touch Average, touch Avgs, and then set the number of averages in the control window.</p> <p>Tip. If you want to redefine your waveform, touch the Clear button and repeat the above steps.</p>	  

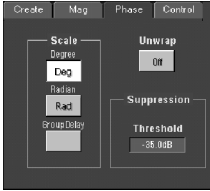

Overview	To define a spectral math waveform	Related control elements & resources
<p>Display the spectral waveform</p>	<p>8. To display your spectral waveform, either touch the Apply or the Ok button.</p> 	

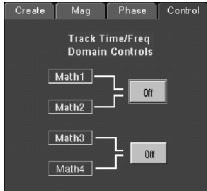

Overview	To define a spectral math waveform	Related control elements & resources
<p>Set the magnitude scale</p>	<p>9. Select the Mag tab.</p> <p>10. To select the vertical scale factor, touch either dB, DBM, or Linear. The units will be dB, W, A, V, or whatever units are attached to the spectral analyzer input waveform.</p> <ul style="list-style-type: none"> ■ dB — Magnitude is displayed using log scale, expressed in dB relative to the reference level offset. ■ Linear — Magnitude is displayed using units equal to the source units. ■ dBm — Reference level offset is set to predefined values for dBm; see next step. <p>Tip. You can adjust the scale and position by first touching the waveform handle and then using the multipurpose knobs to adjust the scale and position.</p> <p>11. To set the reference level, touch Level, and use the multipurpose knobs or keypad to set the reference level.</p> <p>Tip. Reference level is the value at the top of the display screen. It only applies to magnitude waveforms. Adjusting the reference level positions the waveform with respect to the top of the display, but does not change the position of the waveform with respect to its ground reference.</p> <p>12. To set the reference level offset, touch Level Offset and use the multipurpose knobs or keypad to set the offset.</p> <p>Tip. Offset determines where zero dB is in the output waveform. Changing offset moves the waveform with respect to its ground reference. When the input is equal to the offset, it will display as zero dB in the output.</p>	  

Overview	To define a spectral math waveform	Related control elements & resources
<p>Set the phase scale</p>	<p>13. Select the Phase tab.</p> <p>14. To select the vertical scale factor, touch either Degree, Radian, or GroupDelay:</p> <ul style="list-style-type: none"> ■ Degree sets the phase units to degrees. Phase is displayed using degrees as the scale, where degrees wrap from -180° to $+180^\circ$. ■ Radian sets the phase units to radians. Phase is displayed using radians as the scale, where radians wrap from $-\pi$ to $+\pi$. ■ GroupDelay unwraps the phase spectrum and displays its negative derivative. <p>The topic <i>Using the Phase Controls</i>, on page 3-175, provides in depth information on setup for phase displays.</p> <p>15. To specify whether to unwrap phase in a spectral analysis phase waveform, touch Unwrap to toggle it on or off.</p> <p>16. To set the level in dB that a magnitude in the spectrum must exceed in order to have its phase computed (to reduce the effect of noise in your phase waveform), touch Suppression Threshold and use the multipurpose knobs or keypad to set the threshold level. If the magnitude is less than the threshold, then its phase is set to zero (for an example, see Figure 3-47 on page 3-177).</p> <p>The topic <i>Suppression Threshold</i>, on page 3-176, provides additional information on phase suppression.</p>	   
<p>Set time and frequency domain control tracking</p>	<p>17. Touch the Control tab.</p> <p>18. To allow changing time and frequency domain controls for one math waveform to change the same controls for another math waveform, touch the Track Time/Freq Domain Controls buttons to toggle them on or off.</p>	

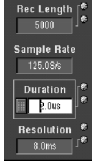
Overview	To define a spectral math waveform	Related control elements & resources
<p>Select the window type</p>	<p>19. To select the window type, touch Window Type and select from the list. See FFT Windows on page 3-178 for a description of the available FFT windows.</p> <p>Rectangular — Best type of window for resolving frequencies that are very close to the same value. Best type for measuring the frequency spectrum of nonrepetitive signals and measuring frequency components near DC.</p> <p>Hamming, Hanning, Blackman-Harris, Kaiser-Bessel, and FlatTop2 — These window are based on cosine series. Each has a different RBW and spectral leakage characteristics. Use the window which best highlights the features you wish to observe in the spectrum.</p> <p>Gaussian — Best localization in both time and frequency.</p> <p>Tek Exponential — Best for impulse testing. It sets the zero-phase reference to the 20% position in the time record allowing the test to use more of the oscilloscope record length.</p> <p>The topic <i>Selecting a Window</i>, on page 3-179, provides in depth information on choosing the right window for your application.</p>	

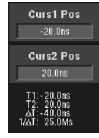
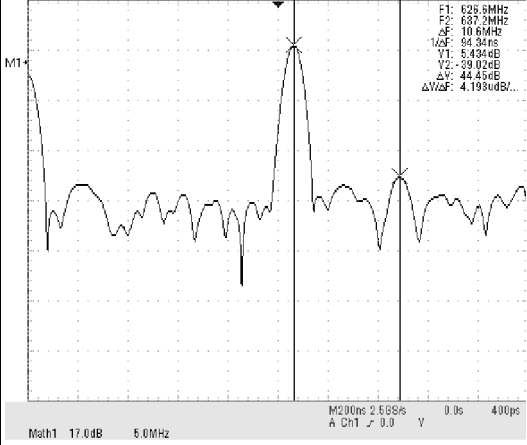

Overview	To define a spectral math waveform	Related control elements & resources
<p>Set the frequency domain controls</p>	<p>The spectral analyzer center frequency and the frequency span must be within the bandwidth setting determined by the sample rate.</p> <p>See Figure 3-44 on page 3-173 to see how a signal consisting of two sine waves looks on screen as the spectral analyzer controls are adjusted. A rectangular window was used.</p> <p>20. To set the frequency range over which the spectral analysis is performed, touch Freq Span and use the multipurpose knobs or keypad to set the frequency range.</p> <p>Higher sample rates allow you to set greater frequency spans. To set the frequency span to the maximum allowed by the current sample rate, touch the Full button.</p> <p>21. To set the center frequency of the spectral analysis, touch Center Freq and use the multipurpose knobs or keypad to set the center frequency.</p> <p>Resolution bandwidth determines how small of a frequency difference may be resolved in the frequency domain output data. It basically defines the bandwidth of the filters used to do the frequency domain analysis.</p> <p>22. To set the resolution bandwidth, touch Res BW and use the multipurpose knobs or keypad to set the resolution bandwidth.</p>	

Overview	To define a spectral math waveform	Related control elements & resources
<p>Set the time domain controls</p>	<p>Time domain controls of the spectral Analyzer determine the sample rate and record length of the acquisition. Front panel controls also affect the sample rate and record length, but not in the same way. These controls allow you to change the duration on the acquisition without changing the sample rate. This allows you to control the acquisition in a way that is the dual to the frequency domain span and center frequency controls in a spectral analyzer.</p> <p>23. From the Spectral Analysis Setup menu, touch Resolution and adjust the time interval between data samples of the input waveform.</p> <p>Note: Resolution is the inverse of Sample rate. Adjust resolution to adjust sample rate. Resolution will also cause a change in record length such that the duration is kept constant at the value selected by the Duration control.</p> <p>24. To adjust the number of seconds over the duration of the acquired waveform (record length), touch Duration and use the multipurpose knobs or keypad to adjust the duration.</p> <p>Note: Changing duration also changes the record length.</p> <p>25. To set the gate position, touch Gate Pos and use the multipurpose knobs or keypad to adjust the gate position.</p> <p>Gate position is the position of the phase reference point in the gate with respect to the trigger in seconds. The gate position and gate duration must be within the acquisition.</p> <p>26. To set the gate duration, touch Gate Dur and use the multipurpose knobs or keypad to adjust the gate duration.</p> <p>Gate duration and resolution bandwidth both control gate duration, gate duration is displayed in seconds and resolution bandwidth in hertz.</p>	   

Overview	To define a spectral math waveform	Related control elements & resources
<p>Take cursor measurements</p>	<p>27. From the tool bar, touch the Cursor button to display the cursors and the cursor control window.</p> <p>28. Select the Math tab and touch the numbered button for the spectral waveform you want to measure.</p> <p>29. Select the cursor type by touching either the H Bars, V Bars, Paired, or Split buttons (for more information, see <i>Taking Cursor Measurements</i> starting on page 3-132):</p> <p>30. Turn the multipurpose knobs to position each cursor on the waveform to measure the feature that interests you.</p> <p>31. Read the results in the cursor readout. The cursor readout is displayed under the multipurpose readouts as shown here or in the upper right corner of the graticule area.</p> <p>The figure shows the cursor measurement of a frequency magnitude on an FFT. The readout reads 0 dB because it is aligned with the 1 V_{RMS} level. The other readout reads 24.4 dB indicating the magnitude of the frequency it is measuring is -24.4 dB relative to 1 V_{RMS}. Display of the source waveform is turned off.</p> <p>The cursor units will be in dB or volts for magnitude waveforms and in degrees or radians for those measuring phase.</p> <p>32. Select V Bars and use the multipurpose knobs to align the two vertical cursors to points of interest along the horizontal axis of the waveform.</p> <p>33. Read the frequency difference between the cursors from the Δ: readout. Read the frequency of each cursor relative to the zero frequency point from the cursors readout.</p>	  
<p>For further assistance</p>	<p>34. Touch the Help button in the tool bar to access context-sensitive help on math waveforms.</p>	 <p>See <i>Accessing Online Help</i> on page 3-245 for an overview of the online help system.</p>

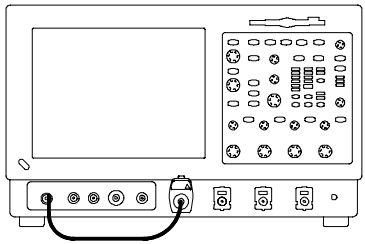
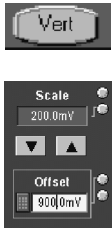
Spectral Math Example The following procedure is an example of setting up the instrument to perform spectral analysis of a signal. This example uses the probe compensation signal available on the front-panel of the instrument.

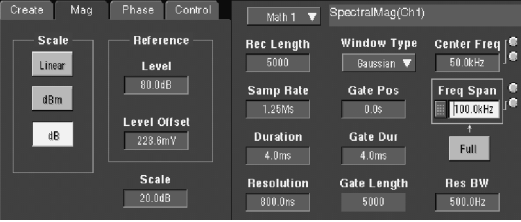
Overview	Spectral math example	Control elements and resources
<p>Install the test hookup</p>	<ol style="list-style-type: none"> 1. Connect the probe compensation signal to CH 1 through a suitable cable and adapter. 2. Press DEFAULT SETUP. 3. Press AUTOSET. 	<p style="text-align: center;">CSA7000 Instrument</p> 
<p>Display the waveform</p>	<ol style="list-style-type: none"> 4. From the button bar, touch Vert, and select the Chan 1 tab. 5. Touch Offset, and using the multipurpose knobs or keypad, set the offset to 900 mV and the Ch1 Scale to 200 mV. 	

<p>Display the spectral math waveform</p>	<p>6. From the button bar, touch Math, and select the Math 1 tab.</p> <p>7. Touch the Predefined Mag button.</p> <p>The instrument sets up a predefined magnitude spectral analysis waveform.</p> <p>8. To see the settings, touch the Spectral Analysis Setup button.</p> <ul style="list-style-type: none"> ■ Scale sets the vertical scale factor, and lets you set the vertical scale. ■ Reference sets the value at the top of the display, and offset sets the waveform position with respect to its ground reference. ■ Rec Length sets the number of samples in the waveform acquisition. ■ Sample rate sets the sample rate. ■ Duration sets the time over the acquired waveform (also changes record length). ■ Resolution controls sample rate and record length to keep the duration constant while changing the time between samples of the acquired waveform. ■ Window Type affects the shape of the spectral analyzer response in the frequency domain, the ability to resolve frequency in the output spectrum. ■ Gate Position sets the position of the gate on the acquired waveform. The data in the gate region is input to the spectral analyzer. The gate position is the time from the trigger to the zero phase reference position in the gate. ■ Gate Duration sets the width of the gate in seconds, and it is inversely proportional to the resolution bandwidth. For narrow band frequency resolution, use a wide gate. ■ Gate Length displays the number of samples over the specified gate duration. ■ Resolution BW sets the bandwidth, in Hertz, of the filters used in the spectral analysis. Resolution BW is inversely proportional to the gate duration. <p>9. Touch Center Freq, and use the multipurpose knobs or keypad to set the frequency span to 100 kHz and the center frequency to 50 kHz.</p>	  
--	--	--

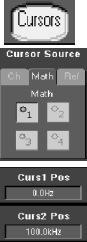
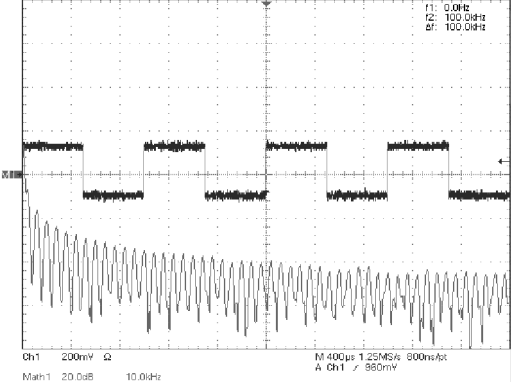
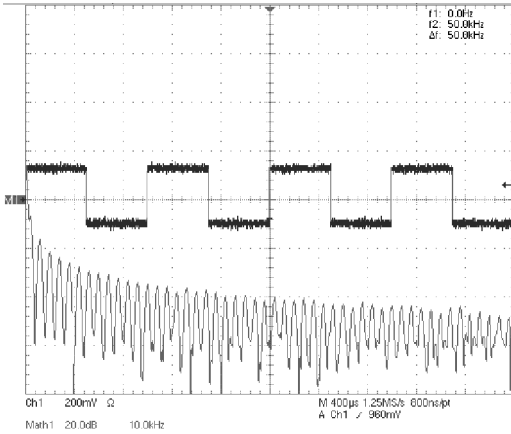
Overview	Spectral math example (cont.)	Control elements and resources
<p>Set up the cursors</p>	<p>10. From the button bar, touch Cursors.</p> <p>11. To assign the cursors to the spectral analysis math waveform, touch the Cursor Source Math tab, and touch the Math 1 button.</p> <p>12. Use the multipurpose knobs or keypad to set the Curs1 Pos to 0.0 Hz and the Curs2 Pos to 100 kHz.</p> <p>The cursor readout now indicates the frequency span set in step 9.</p> <p>13. Use the multipurpose knobs or keypad to set the Curs2 Pos to 50 kHz.</p> <p>The cursor readout now indicates the center frequency set in step 9.</p>	  

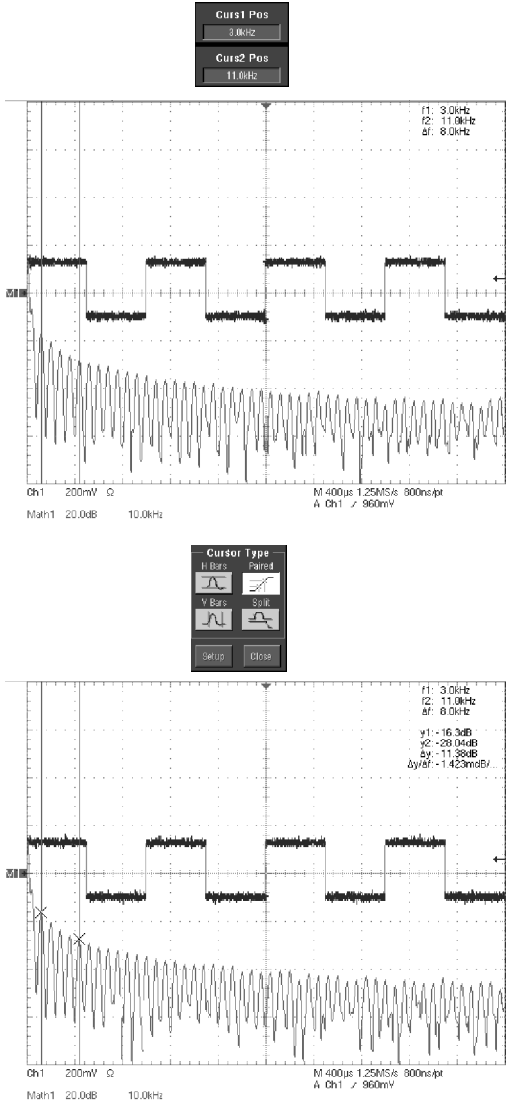
Overview	Spectral math example (cont.)	Control elements and resources
<p>Measure the test results</p>	<p>14. Use the multipurpose knobs or keypad to set the Curs1 Pos to 3.0 kHz and the Curs2 Pos to 11.0 kHz.</p> <p>In this example, the cursors are now on the third and eleventh harmonic of the probe compensation signal. Read the frequencies from the cursor readouts.</p> <p>15. Touch the Cursor Type Paired button.</p> <p>Now in addition to the frequency at the cursor locations, the cursor readout displays the amplitude at the cursor locations. The readout also displays the difference in frequency and amplitude between the cursor locations.</p>	 <p>The figure shows two screenshots of a spectral math waveform. The top screenshot shows a waveform with two vertical cursors. The top readout shows: Curs1 Pos: 3.0kHz, Curs2 Pos: 11.0kHz. The bottom screenshot shows the same waveform with the cursors now displaying amplitude and difference values: y1: -16.3dB, y2: -28.0dB, Δy: -11.7dB, Δf: -1.42kHz. The waveform is labeled with 'Ch1', 'Math1', and various settings like '200mV', '10.0kHz', 'M 400µs', '1.25MS/s', '800ns/pt', and 'A Ch1 / 960mV'.</p>
<p>For more information</p>	<p>16. For additional information on setting up and using spectral math, see <i>Defining Spectral Math Waveforms</i> starting on page 3-168.</p>	

Data Input/Output

This section describes the input and output capabilities of your oscilloscope. Specifically, it covers:

- *Saving and Recalling a Setup* on page 3-205
- *Saving and Recalling Waveforms* on page 3-213
- *Exporting and Copying Waveforms* on page 3-223, including exporting and copying of images, waveforms, measurements, and histograms
- *Printing Waveforms* on page 3-238
- *Remote Communication* on page 3-243

Saving and Recalling a Setup

This oscilloscope can save a number of different oscilloscope setups for later recall, limited only by the space you have to store the setups.

By saving and recalling different setups, you can switch from setup to setup without having to first manually record your settings and then manually set them. This capability is helpful when you want to:

- Save and recall a setup that optimizes the oscilloscope for displaying and analyzing a certain signal.
- Save a series of setups to help automate a procedure through recall of a sequence of saved setups as part of performance of the procedure.
- Export a setup for sharing with a second oscilloscope.

The Save-Setup and the Recall-Setup control windows provide for including and viewing comments with your saved setups. You can store information, readable upon recall, that describes each setup you save and its intended application.

If you do not have a keyboard connected, you can still enter comments and name setup files. The Save and Recall Setup windows include the Virtual Keyboard. When you touch or click a setup name, the oscilloscope displays a keyboard on screen that you can use with your mouse or the touch screen to enter the setup-path name, setup-file name, and comment.

The oscilloscope excludes the following items when saving setups:

- Waveforms in Ch1 to Ch4 and references (Ref1-Ref4). Control settings (scale, position, and so on) are saved but not the waveform data. Upon recall of the setup, the settings are applied, but the data is not restored.
- Waveforms in Math Waveforms (Math1-Math4). Control settings and the math expression are retained but not the waveform data. Upon setup recall, however, the recalled math waveform expressions will be applied, but math waveform data is not restored.
- User Options that are stored in the Windows Registry. These include all options accessed by first selecting Utilities (menu bar), and then User Preferences (Utilities menu).

You cannot recall into a channel or a math waveform. The oscilloscope recalls each waveform into one of the reference waveform locations (Ref1-Ref4).

If you want to save a waveform in a useful format for other applications, such as a spreadsheet, use the export function (see *Exporting and Copying Waveforms* on page 3-223).

A few things to remember when saving and recalling setups follow:

All Settings are Retained. The oscilloscope includes almost all oscilloscope settings, with a few exceptions (such as user options) in the saved setup.

Retaining Current Settings. Recalling a setup replaces the current setup with the recalled setup. If you do not want to lose your current setup, save it to its own setup file for later recall before you recall a setup.

Avoiding Setup/Waveform Mismatches. Saved setups may contain settings inappropriate for waveforms currently in your oscilloscope. For example: if you save a setup that displays a math waveform that is the inverse of reference 1, when you recall the setup, if the reference is empty, the math and reference waveforms are not displayed.

Using Auto-Increment File Name

Auto-increment file name in the Save As and Export dialog boxes, enables saving numerous files without entering a file name each time. To auto-increment file names, select Auto-increment file name on the dialog box as shown in Figure 3-59.

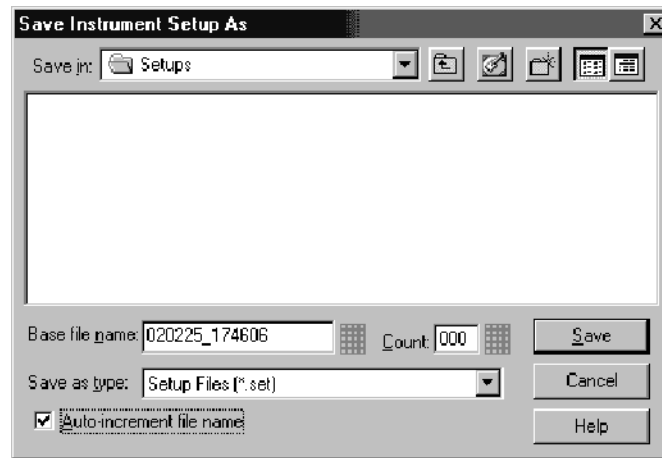

Figure 3-59: Auto-increment file name feature

Enter a Base file name and click Save. For the initial save, the default count is 000. Your first file is saved as *[Basefilename][count].ext*, where *ext* is the file extension. On subsequent saves, the oscilloscope searches for the highest numbered file name and increases the number by one, as in *Basefilename001.ext*.



For example, if you save a series of rise time data files, you can use *Risetime* as the base file name. Your first file is saved as *Risetime000.ext*. The next file will be *Risetime001.ext*, and so on.

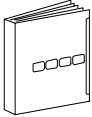
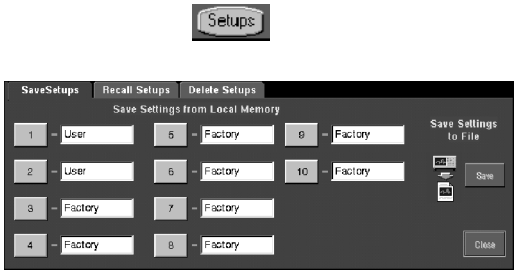
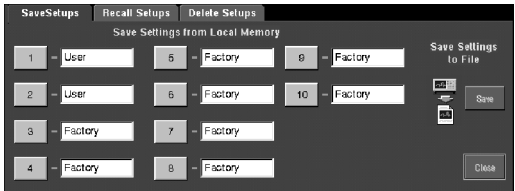

If Count reaches 999, it is suggested that you change the base file name to *Basefilename1* (for example, *Risetime1*) on the next save. Your next file will then be saved as *Risetime1000.ext*.

To Save Your Setup

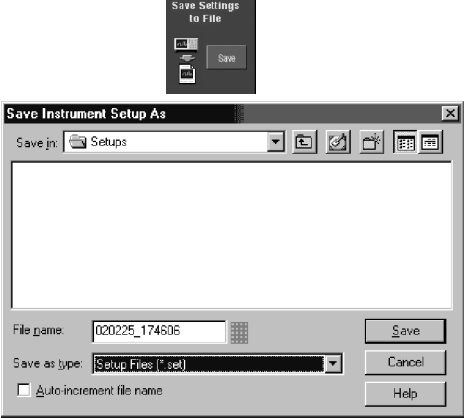

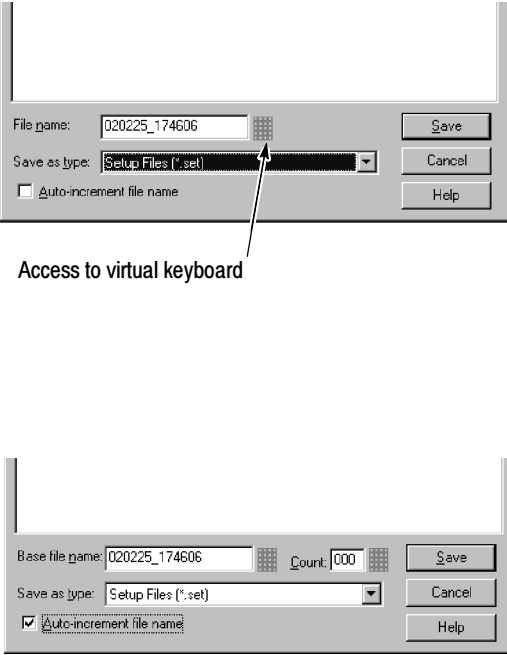

Use the procedure that follows to save a setup to one of ten internal locations, the oscilloscope hard disk, a floppy disk, or third-party storage device.

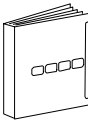

Overview	To save your setup	Control elements and resources
<p>Prerequisites</p>	<ol style="list-style-type: none"> The oscilloscope must be powered up. Setup the oscilloscope controls as you want them saved as part of a recallable setup. <p>For help in making your setup, check the references at right and other sections in this chapter specific to the setup you wish to make.</p>	 <ul style="list-style-type: none"> See <i>Powering On the Oscilloscope</i> on page 1-8. See page 3-27 for acquisition setup. See page 3-53 for trigger setup.
<p>Display the setups control window</p>	<ol style="list-style-type: none"> From the tool bar, touch Setups and select the Save Setups tab of the Setups control window. 	
<p>Save the setup</p>	<ol style="list-style-type: none"> Touch the number of the setup in which you want to save your setup. Data in the existing setup will be overwritten. 	

Overview	To save your setup (Cont.)	Control elements and resources
<p>Name your setup</p>	<p>5. Name your setup file by either:</p> <ul style="list-style-type: none"> ■ Accepting the default name (User) that appears in the name field. ■ Double clicking in the name field and using the keyboard window to enter a new name, replacing the default file name. <p>Note. You can use the mouse or touch screen with the virtual keyboard to type entries in the name field.</p> <ul style="list-style-type: none"> ■ Clicking the existing name and using an attached keyboard to enter a new name. 	
<p>To save to a file</p>	<p>6. To display the Save Instrument Setup As dialog, from the Setup control window, touch Save.</p> <p>The Save Instrument Setup dialog allows for the entry of a file name, file type, and location. See below.</p>	
<p>Name a destination</p>	<p>7. Use the Save in: drop-down list and buttons (see right) to navigate to the directory in which to save your setup.</p>	

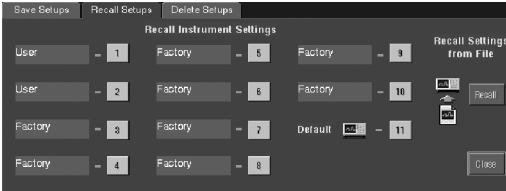
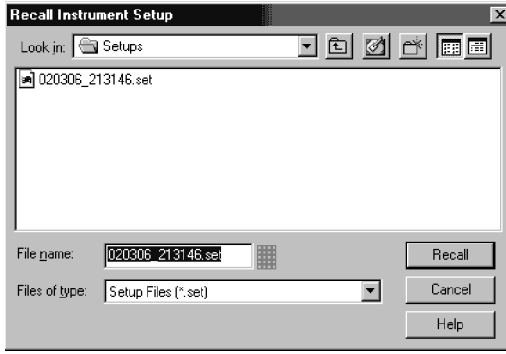
Overview	To save your setup (Cont.)	Control elements and resources
<p>Name your setup</p>	<p>8. Name your setup file by doing one of the following steps:</p> <ul style="list-style-type: none"> ■ Accepting the default file name that appears in the File name: field. ■ Clicking in the File name field and typing a new name, replacing the default file name. ■ Clicking an existing name in the file list (if any are listed). Data in the existing file will be overwritten. <p><i>Note. If your oscilloscope lacks a keyboard, touch or click the keyboard icon to display a virtual keyboard. You can use the mouse or touch screen with the virtual keyboard to type entries in the name fields and comments fields.</i></p> <p>Select the Auto-increment file name check box to save a series of files without typing in a new name each time. For more information, see <i>Using Auto-Increment File name</i> on page 3-206.</p> <p>9. If not selected, select *.set in the Save as type field as the type of file to save. (Setup files are always type *.set.)</p> <p><i>Note. Only change the type if you want to temporarily see any other types of files in the current directory. Otherwise, leave it set at *.set.</i></p>	 <p>Access to virtual keyboard</p>
<p>Save your setup</p>	<p>10. Touch the Save button to save the setup file. To cancel without saving, touch the Cancel button.</p>	
<p>For further assistance</p>	<p>11. For more help on saving setups, touch the Help button in the tool bar to access contextual help on screen.</p>	 <p>See page 3-245 to learn about using online help.</p>

To Recall Your Setup Use the procedure that follows to recall a setup to the oscilloscope. Remember that recalling a setup replaces the existing setup, which is lost.

Overview	To recall your setup	Control elements and resources
Prerequisites	<p>1. The oscilloscope must be powered up. You must have access to a setup saved by the oscilloscope.</p> <p>Note. This procedure does not make the setup active.</p>	 <p>See <i>Powering On the Oscilloscope</i> on page 1-8.</p>
Display the setups control window	<p>2. From the tool bar, touch Setups and select the Recall Setups tab of the Setups control window.</p>	
Recall the setup	<p>3. Touch the number of the setup that you want to recall. The current oscilloscope setup is overwritten.</p>	
Recall setup from a file	<p>4. To display the Recall Instrument Setup dialog, from the Recall Setup control window, touch Recall. (See right.)</p> <p>The Recall Instrument Setup dialog allows navigation to directories, lists setup files in the directory, and provides for selection of a setup file.</p>	
Find the source directory	<p>5. Use the Look in: drop down list and buttons (see right) to navigate to the directory which contains a setup that you want to recall.</p>	

Overview	To recall your setup (Cont.)	Control elements and resources
<p>Select your setup</p>	<p>6. If not selected, select *.set in the Save as type of file to include in the file listing. (Setup files are always type *.set.)</p> <p>Note. Only change the type if you want to temporarily see other types of files in the current directory. Otherwise, leave it set at *.set.</p> <p>7. Choose your setup file by either:</p> <ul style="list-style-type: none"> ■ Clicking an existing name in the file list. ■ Clicking in the File name field and typing a new name, replacing the default file name. <p>Note. If your oscilloscope lacks a keyboard, touch or click on the icons as indicated right to display a virtual keyboard. You can use the mouse or touch screen with the virtual keyboard to type entries in the name fields and comments fields.</p>	 <p>Access to virtual keyboard</p>
<p>Recall your setup</p>	<p>8. Click the Recall button to recall the setup file. To cancel without recalling a setup, click the Cancel button.</p>	
<p>For further assistance</p>	<p>9. For more help on recalling setups, click the Help button in the tool bar to display contextual help on screen.</p>	 <p>See page 3-245 to learn about using online help.</p>

Saving and Recalling Waveforms

This oscilloscope can save any number of waveforms, limited only by the space you have to store them.

By saving a waveform, you can recall it at a later time for comparison, evaluation, and documentation. This capability is helpful when you want to:



- Recall a waveform for further evaluation or comparison with other waveforms.
- Extend the waveform carrying capacity of the oscilloscope. The oscilloscope supports four reference, four channel, and four math waveforms. If you want more than four references, you can save the additional reference to disk for recall later.





The Reference-Waveform control window contains a Label field for including comments with your saved waveforms. That way, you can store information, readable upon recall, describing each waveform that you save.

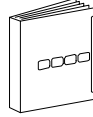

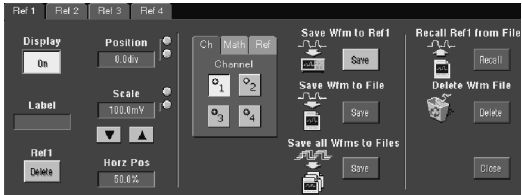

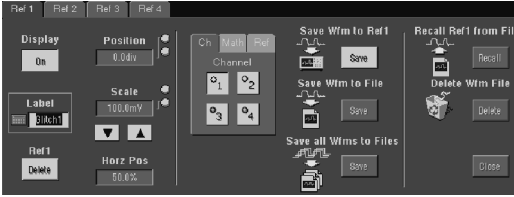
Virtual Keyboarding. If you do not have a keyboard connected, you can still enter comments and name waveform files. The Reference control window includes a Keyboard button. When you touch or click it, the oscilloscope displays a virtual keyboard on screen that you can use with your mouse or the touch screen to enter the waveform-path name, file name, and comment.

You cannot recall a waveform *into* a channel or a math waveform. The oscilloscope recalls each waveform into one of the reference waveform locations (Ref1-Ref4).

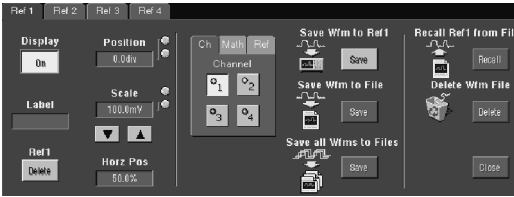
To Save Your Waveform Use the procedure that follows to save a waveform or waveforms to a reference location, the oscilloscope hard disk, a floppy disk, or third party storage device.

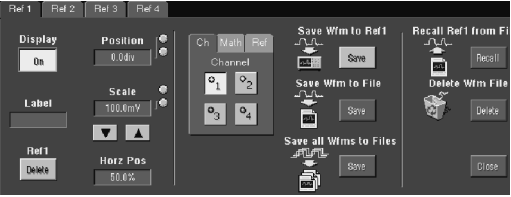
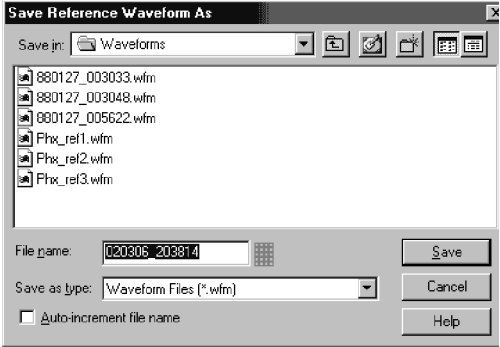
Overview	To save a waveform	Control elements and resources
<p>Prerequisites</p>	<ol style="list-style-type: none"> The oscilloscope must be powered up. Make sure the waveform to be saved exists; that is, your source must be a channel, an active math waveform, or an active reference. Display the waveform with the setup in which you want to save it. For help in setup and acquiring waveforms, check the references at right. 	 <ul style="list-style-type: none"> See <i>Powering On the Oscilloscope</i> on page 1-8. See page 3-27 for acquisition setup. See page 3-53 for trigger setup.
<p>Display the reference control window</p>	<ol style="list-style-type: none"> From the tool bar, touch Refs and select the Ref 1 to Ref 4 tab of the reference in which you want to save the waveform. 	
<p>Select the waveform to save</p>	<ol style="list-style-type: none"> Select the Ch, Math, or Ref tab of the waveform that you want to save, and then touch the number of the channel, math, or reference waveform that you want to save. 	

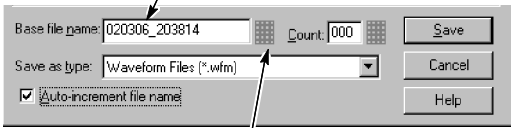
Overview	To save a waveform (Cont.)	Control elements and resources
<p>Label the waveform</p>	<p>5. If you want to label the waveform, touch Label, and use your keyboard or the pop-up keyboard to create a label for your waveform.</p> <p>You can label any channel, math, or reference waveform and position the label relative to the display edge and the vertical position of the waveform using the Label control window:</p> <ul style="list-style-type: none"> ■ Using the menu bar, select Vertical and then Label ■ From the Label control window, select the waveform that you want to label using the Source buttons ■ From the Label control window, touch Label, and use your keyboard or the pop-up keyboard to create a label for your waveform ■ Position the label relative to the waveform using the multipurpose knobs, your keyboard, or the pop-up keyboard 	    
<p>Save the waveform to a reference</p>	<p>6. Touch Save Wmf to Ref(x) Save to save your waveform. Data in the existing reference will be overwritten.</p>	



Overview	To save a waveform (Cont.)	Control elements and resources
<p>Save the waveform to a file</p>	<p>7. To save the waveform to a file, touch Save Wfm to File Save, or to save all active waveforms to files, touch Save all Wfms to Files.</p> <p>The Save Reference Waveform As window lists all available waveforms, allows for browsing to a destination directory (saving to file), naming the waveform file, and selecting the file format.</p>	 
<p>Select a destination</p>	<p>8. Use the Save in: drop down list and buttons (see right) to navigate to the directory in which to save your waveform.</p>	
<p>Select directory and name file</p>	<p>9. Specify the filename in which to save your waveform You can:</p> <ul style="list-style-type: none"> ■ Use the default name and directory appearing in the File Path field. ■ Rename the file by typing a new name into the File name field. ■ Select the Auto-increment file name check box to save a series of files without typing in a new name each time. For more information, see <i>Using Auto-Increment File Name</i> on page 3-206. 	<p style="text-align: center;">Edit path and file name</p>  <p style="text-align: center;">Access to virtual keyboard</p>
<p>Save your waveform</p>	<p>10. Click the Save button to save the waveform file or reference. To cancel without saving, click the Cancel button.</p>	



Overview	To save a waveform (Cont.)	Control elements and resources
For further assistance	11. For more help on saving waveforms, touch the Help button in the tool bar to access the contextual online help.	 See page 3-245 to learn about using online help.



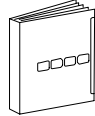
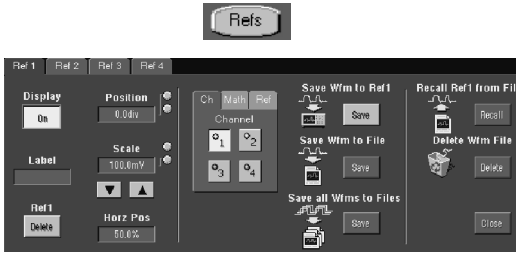

To Recall Your Waveform

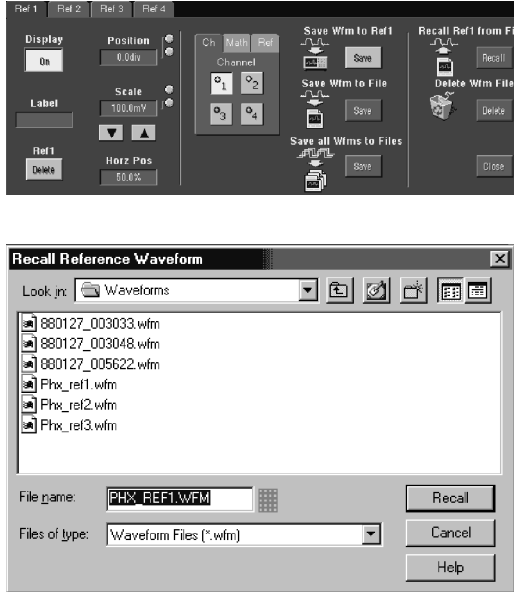
Use the procedure that follows to recall a waveform to a reference. You can only recall waveforms into references.

NOTE. Reference waveforms do not recall because they are already oscilloscope resident. You can copy a reference waveform to another reference: first display the reference to be copied, and then use the Save Waveform procedure to save it to another reference (Ref1-Ref4).

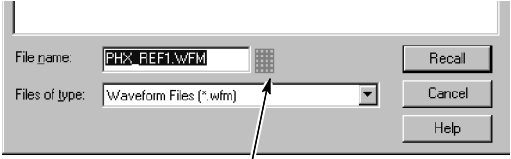
Overview	To recall your waveform	Control elements and resources
<p>Prerequisites</p>	<p>1. The oscilloscope must be powered up. You must have access to a waveform saved by the oscilloscope.</p>	 <ul style="list-style-type: none"> See <i>Powering On the Oscilloscope</i> on page 1-8.
<p>Display the reference control window</p>	<p>2. From the tool bar, touch Refs, and select the Ref 1 to Ref 4 tab of the reference in which you want to recall the waveform.</p>	
<p>Recall the waveform</p>	<p>3. If recalling an internal reference, touch Display to toggle the display of the reference waveform on.</p>	

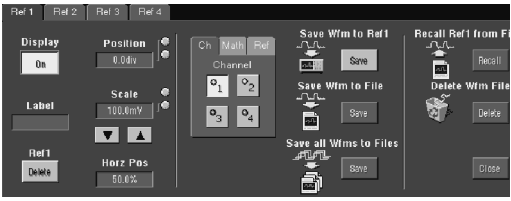

Overview	To recall your waveform (Cont.)	Control elements and resources
<p>Recall a reference waveform from a file</p>	<p>4. To display the Recall Reference Waveform window, from the Recall Ref(x) from File window, touch Recall. (See right.)</p> <p>The Recall Reference Waveform window allows navigation to directories, lists waveform files in the directory, and provides for selection of a waveform file.</p>	 <p>The top screenshot shows the 'Recall Ref1 from File' window with buttons for 'Recall!!', 'Delete Wfm File', and 'Close'. The bottom screenshot shows the 'Recall Reference Waveform' dialog box with a file list, a 'File name' field containing 'PHX_REF1.WFM', and buttons for 'Recall', 'Cancel', and 'Help'.</p>
<p>Find the source directory</p>	<p>5. Use the Look in: drop down list and buttons (see right) to navigate to the directory which contains a waveform that you want to recall.</p>	 <p>The screenshot shows the 'Recall Reference Waveform' dialog box with the 'Look in:' field set to 'Waveforms' and navigation buttons.</p>

Overview	To recall your waveform (Cont.)	Control elements and resources
<p>Select your waveform</p>	<p>6. If not selected, select *.wfm in the Files of type field to force the file listing to only include these types. Use *.wfm for waveforms.</p> <p>Note. Only change the type if you want to temporarily see any other types of files in the current directory. Otherwise, leave it set to *.wfm.</p> <p>7. Choose your waveform file by either:</p> <ul style="list-style-type: none"> ■ Clicking an existing name in the file list. ■ Clicking in the File name field and typing a new name, replacing the default file name. <p>Note. If your oscilloscope lacks a keyboard, touch or click the Open Keyboard button to display a virtual keyboard. You can use the mouse or touch screen with the virtual keyboard to type entries in the name fields.</p>	 <p>Access to virtual keyboard</p>
<p>Recall your waveform</p>	<p>8. Click the Recall button to recall the waveform file. To cancel without recalling a waveform, click the Cancel button.</p>	
<p>Display your reference waveform</p>	<p>9. Touch Display to toggle the display of the reference waveform on.</p>	
<p>For further assistance</p>	<p>10. For more help on recalling waveforms, touch the Help button to access contextual online help.</p>	 <p>See page 3-245 to learn about using online help.</p>

To Clear References

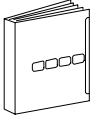
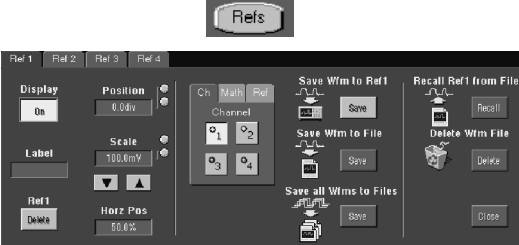
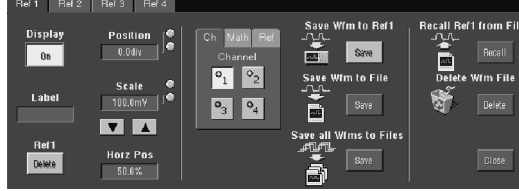
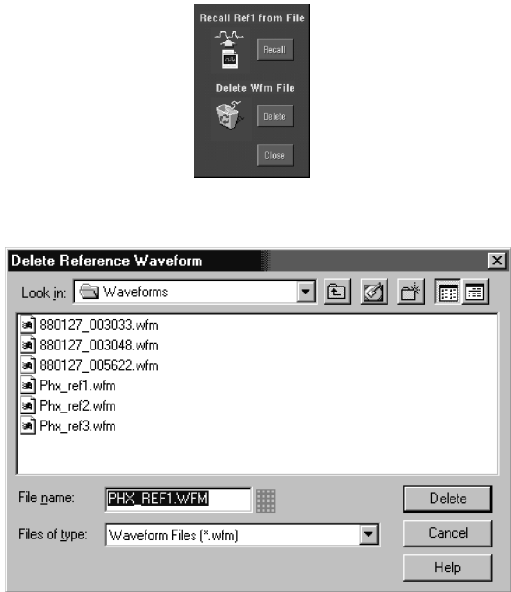
You can clear individual references of data or delete waveform files. If you are sure you don't want the data a reference waveform contains, use the procedures that follow to clear it. To clear all references and setups, use Tek Secure.

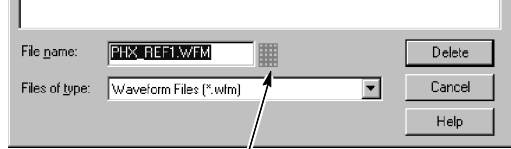
Overview	To clear references	Control elements and resources
<p>Prerequisites</p>	<p>1. The oscilloscope must be powered up. You must have access to a waveform saved by the oscilloscope.</p>	 <ul style="list-style-type: none"> See <i>Powering On the Oscilloscope</i> on page 1-8.
<p>Display the reference control window</p>	<p>2. From the tool bar, touch Refs, and select the tab (Ref 1 to Ref 4) of the reference that you want to delete.</p>	
<p>Delete the reference</p>	<p>3. Touch Delete to delete the reference waveform.</p>	
<p>Delete a reference waveform file</p>	<p>4. To display the Delete Reference Waveform window, from the Delete Wfm File window, touch Delete. (See right.)</p> <p>The Delete Reference Waveform window allows navigation to directories, lists waveform files in the directory, and provides for selection of a waveform file.</p>	

Overview	To clear references (Cont.)	Control elements and resources
<p>Find the file directory</p>	<p>5. Use the Look in: drop down list and buttons (see right) to navigate to the directory of the file to delete.</p>	
<p>Find your file</p>	<p>6. Select the file type in the Files of type drop down list to force the file listing to only include these types. Use *.wfm for waveforms.</p> <p><i>Note. Only change the type if you want to temporarily see any other types of files in the current directory. Otherwise, leave it set to *.wfm for waveforms.</i></p> <p>7. Choose your waveform file by clicking an existing name in the file list.</p> <p><i>Note. If your oscilloscope lacks a keyboard, touch or click the Open Keyboard button to display a virtual keyboard. You can use the mouse or touch screen with the virtual keyboard to type entries in the name fields.</i></p>	 <p>Access to virtual keyboard</p>
<p>Delete the file</p>	<p>8. Click the Delete button to Delete the file. To cancel without deleting a file, click the Cancel button.</p>	
<p>For further assistance</p>	<p>9. For more help on deleting files, touch the Help button to access contextual online help.</p>	 <p>See page 3-245 to learn about using online help.</p>

Exporting and Copying Waveforms

This oscilloscope also supports export of waveform data to a file. The oscilloscope can export waveforms, images, and measurements in several formats. You can also copy waveform data to the clipboard for use with other applications.

By exporting a waveform, you can use it with other analysis tools, such as spreadsheets or math-analysis applications.

A few things to remember when exporting waveforms follow:

Waveforms export as a series of comma-separated values (CSV), which are amplitudes without units. There is no timing information, but data is placed in the file in sequence from the first sample in the waveform record to the last.

Because the waveforms are exported as CSV, without timing and scaling information, the oscilloscope does not import these waveforms directly. If you intend to recall a waveform later, save it (see the procedure *To Save Your Waveform* on page 3-214) instead of exporting it.

You may also choose to copy a waveform and paste it directly into an application such as Microsoft Word or Excel. If so, select your waveform, and then select Copy in the Edit menu.

File Formats. To make exported files more useful, you may select a file format usable by your analysis tools:

- Numeric creates files (.txt) in a numeric format usable by text and word processors.
- Text creates files (.txt) in a text format usable by text and word processors.
- Bitmap creates files (.bmp) in a bitmap file format usable by many graphic programs.
- JPEG creates files (.jpg) in a compressed image format usable by many graphic programs.
- PNG creates files (.png) in a compressed image format that is nonlossy.
- Spreadsheet creates files (.CSV) in a format usable by spreadsheets (Excel, Lotus 1-2-3, and Quattro Pro).
- MathLab creates files (.DAT) in a format usable by MathLab.
- MathCad creates files (.DAT) in a format usable by MathCad.

Note that the MathCad file is an ASCII file, the first four values of which contain header information:

- The first header value holds the record length.

- The second header value holds time, in seconds, between samples.
- The third header value holds the trigger position (expressed as an index in the data position).
- The fourth header value refers to the fractional trigger position.

Also note that the delimiters are carriage returns.

To Export Your Waveform

Use the procedure that follows to export a waveform or waveforms to the oscilloscope hard disk, a floppy disk, or third party storage device.

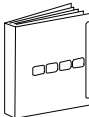
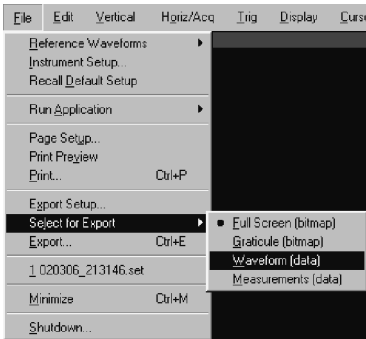
Overview	To save a waveform	Control elements and resources
<p>Prerequisites</p>	<ol style="list-style-type: none"> 1. The oscilloscope must be powered up. 2. Make sure the waveform, image, or measurement to be exported exists; that is, your source must be a channel, an active math waveform, an active reference, and so forth. 	<div style="text-align: center;">  </div> <ul style="list-style-type: none"> ■ See <i>Powering On the Oscilloscope</i> on page 1-8. ■ See page 3-27 for acquisition setup. ■ See page 3-53 for trigger setup.
<p>Select for export</p>	<ol style="list-style-type: none"> 3. From the menu bar, select File, and then select Select for Export. See right. <p>The menu lists all available waveform, image, and measurement types available for export:</p> <ul style="list-style-type: none"> ■ Full Screen to export a bitmap of all screen contents ■ Graticule to export a bitmap of only the graticule area ■ Waveform to export waveform data ■ Measurements to export measurement data 	



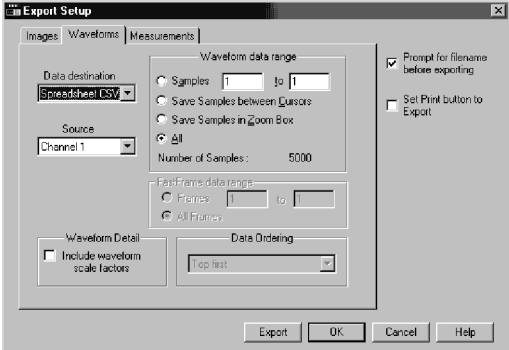
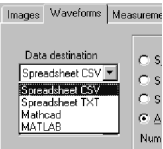
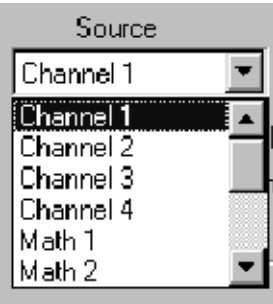
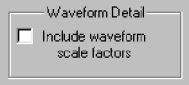
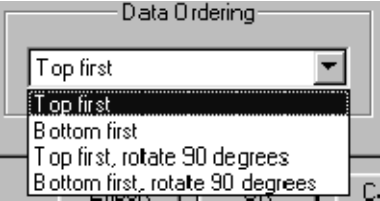

Overview	To save a waveform (Cont.)	Control elements and resources
Select setup for export	4. From the menu bar, select File, and then select Export Setup to display the Export Setup control window.	 A screenshot of a software menu bar with 'File', 'Edit', 'Vertical', and 'Horiz/Act' visible. The 'File' menu is open, showing options: 'Reference Waveforms', 'Instrument Setup...', 'Recall Default Setup', 'Run Application', 'Page Setup...', 'Print Preview', 'Print...' (with 'Ctrl-P' to its right), 'Export Setup...' (highlighted with a dark background), 'Select for Export', and 'Export...'. Right-pointing arrows are next to 'Reference Waveforms', 'Run Application', 'Select for Export', and 'Export...'.

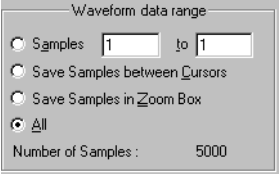
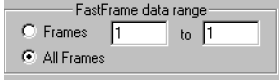

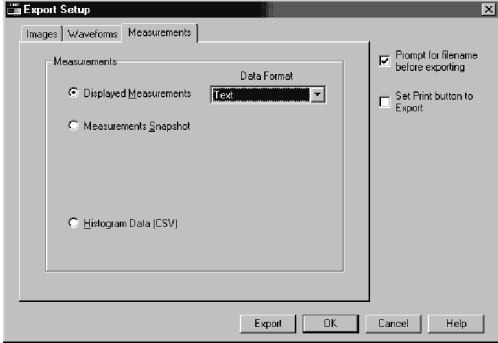
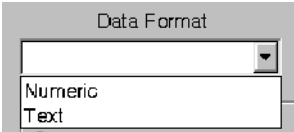
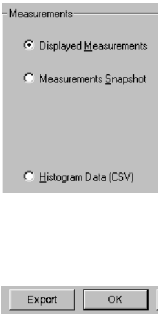
Overview	To save a waveform (Cont.)	Control elements and resources
<p>Setup to export images</p>	<ol style="list-style-type: none"> 5. Select the Images tab to display the Images control window. 6. In the Palette window, select Color, GrayScale, or Black & White for the color palette of your exported images. 7. In the View window, select whether you want to export the Full Screen or Graticules Only. 8. In the Image window, select whether you want to export using Normal, InkSaver, or InkSaver with Enhanced Waveform Color Mode. <ul style="list-style-type: none"> ■ Normal exports the image exactly as it appears on-screen ■ InkSaver exports the image with a white background ■ InkSaver with Enhanced Waveform Color exports the image with colors designed to print with the white background 9. Touch Data Format, and select the data format from the drop-down list. 	 <p>The image shows two screenshots of the 'Export Setup' dialog box. The top screenshot shows the 'Images' tab selected, with 'Color' chosen in the Palette, 'Normal' in the Image, 'Full Screen' in the View, and 'Bitmap (BMP)' in the Data Format dropdown. The bottom screenshot shows the same dialog box, but the Data Format dropdown is open, displaying a list of options: 'Bitmap (BMP)', 'Bitmap (BMP)', 'JPEG', and 'PNG'.</p>

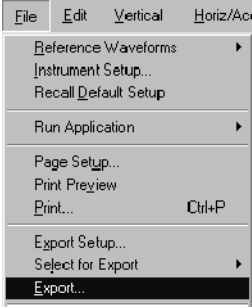
Overview	To save a waveform (Cont.)	Control elements and resources
<p>Setup to export waveforms</p>	<p>10. Select the Waveforms tab to display the Waveforms control window.</p> <p>11. Touch Data Destination, and select the destination (format) of your exported waveform file (see <i>File Formats</i> on page 3-223 for information on the available formats).</p> <p>12. Touch Source Waveform, and select the source of the waveform (a channel, math, or reference waveform) to export from the list.</p> <p>13. If you want waveform scale factors and time values included in your MathCad/Mathlab files, click Include waveform scale factors; if not checked, only voltage (vertical) values are exported.</p> <p>14. Touch Data Ordering, and select the data order (top first, bottom first, or rotate) from the list.</p>	    

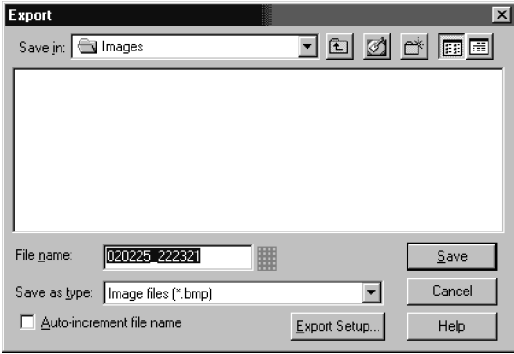
Overview	To save a waveform (Cont.)	Control elements and resources
	<p>15. In the Waveform data range window, select the data to include in the exported files:</p> <ul style="list-style-type: none"> ■ Samples to enter the data range of the data to include in the exported files ■ Save Samples between Cursors to include data between the cursors in the exported files ■ Save Samples in Zoom Box to include data in the zoom box in the exported files ■ All to include all data in the exported files <p>16. If using FastFrame, select the frame range to include in the exported files:</p> <ul style="list-style-type: none"> ■ All Frames to include all frames in the exported files ■ Frames to enter a range of frames to include in the exported files 	 <p>The screenshot shows a dialog box titled "Waveform data range". It contains three radio button options: "Samples" (with input fields for "1" and "1"), "Save Samples between Cursors", and "Save Samples in Zoom Box". The "All" option is selected. Below the options, it says "Number of Samples : 5000".</p>  <p>The screenshot shows a dialog box titled "FastFrame data range". It contains two radio button options: "Frames" (with input fields for "1" and "1") and "All Frames". The "All Frames" option is selected.</p>

Overview	To save a waveform (Cont.)	Control elements and resources
<p>Setup to export measurements</p>	<p>17. Select the Measurements tab to display the Measurements control window.</p> <p>18. Touch Data Format, and select the data format (text or numeric) from the list.</p> <p>19. Select the Measurements that you want to export:</p> <ul style="list-style-type: none"> ■ Displayed Measurements exports measurements that are displayed on screen ■ Measurements Snapshot exports a snapshot of all measurements ■ Histogram Data exports current histogram data <p>20. Select OK to accept your changes, Cancel to close the window without making changes, or Help to access more information.</p>	  

Overview	To save a waveform (Cont.)	Control elements and resources
<p>Export your file</p>	<p>21. To export the file, from the application menu bar, select Export.</p> <p>You can also attach the front-panel PRINT button to Export. Then, pressing the PRINT button will export your file. Do the following to attach the PRINT button to Export:</p> <ul style="list-style-type: none"> ■ From the menu bar, select File, and then select Export Setup to display the Export Setup control window ■ Touch Set Print button to Export <p>The Export window lists all available waveforms, allows for browsing to the destination directory, naming the file, and selecting the file format.</p>	  
<p>Select a destination</p>	<p>22. Use the Save in: drop down list and buttons (see right) to navigate to the directory in which you want to save the file.</p>	

Overview	To save a waveform (Cont.)	Control elements and resources
<p>Name the file</p>	<p>23. Select the file type in the Save as type drop down list to force the file listing to only include these types. Use *.dat for waveforms.</p> <p>Note. Only change the type if you want to temporarily see any other types of files in the current directory. Otherwise, leave it as set by the Export Setup control window.</p> <p>24. Specify the filename in which to save your waveform. You can:</p> <ul style="list-style-type: none"> ■ Use the default name and directory appearing in the File name field. ■ Rename the file by typing a new name into the File name field. ■ Select the Auto-increment file name check box to save a series of files without typing in a new name each time. For more information, see <i>Using Auto-Increment File Name</i> on page 3-206. <p>Note. If your oscilloscope lacks a keyboard, touch or click the keyboard icon button to display a virtual keyboard. You can use the mouse or touch screen with the virtual keyboard to type entries in the name fields.</p>	<p>Control window for saving a waveform. The File name field contains 020225_222321. The Save as type dropdown is set to Image files (*.bmp). The Auto-increment file name checkbox is unchecked. Buttons for Save, Cancel, Export Setup..., and Help are visible.</p> <p>Control window for saving a waveform with auto-increment. The Base file name field contains 020225_222321 and the Count field contains 000. The Save as type dropdown is set to Image files (*.bmp). The Auto-increment file name checkbox is checked. Buttons for Save, Cancel, Export Setup..., and Help are visible.</p> <p>Access to virtual keyboard</p> 
<p>Save the file</p>	<p>25. Click the Save button to save the file. To cancel without saving a file, click the Cancel button.</p>	
<p>For further assistance</p>	<p>26. For more help on exporting files, touch the Help button to access contextual online help.</p>	 <p>See page 3-245 to learn about using online help.</p>

To Use an Exported Waveform

How you use the exported waveform depends on your application. The following example is a simple application; the procedure is general and may require adapting for your spreadsheet or other data-analysis tool.

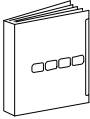
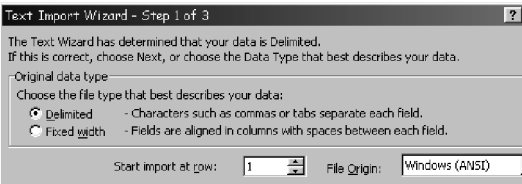
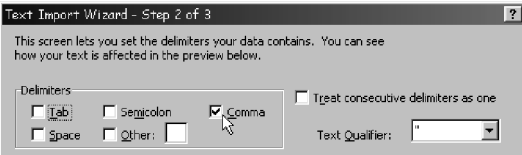
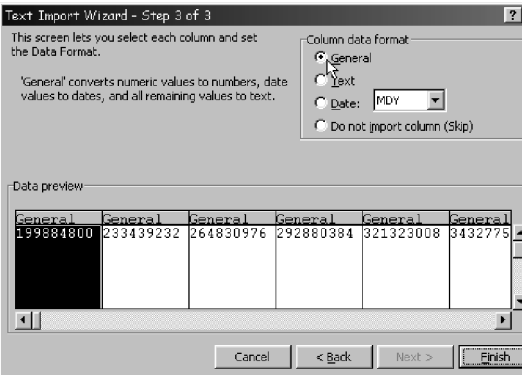
Overview	To use exported waveforms	Control elements and resources												
<p>Prerequisites</p>	<ol style="list-style-type: none"> MS Excel 97 running on a PC or on the oscilloscope. Access to a waveform exported by the oscilloscope. 	 <ul style="list-style-type: none"> See <i>To Save Your Waveform</i> on page 3-214. 												
<p>Import the waveform data</p>	<ol style="list-style-type: none"> In Excel, select Open from the File menu. Use the window that pops up to navigate to the directory containing the file. In the dialog that displays, make the selections as shown at the right as you navigate through the Text Import Wizard. You must select delimiter as your data type, comma as the delimiter type, and General as your Column data format. <p>Note. This step assumes MS Excel 97; your tool may have similar import features for comma-separated data. Check its documentation.</p> <p>Note. To plot 2 channels, export the first channel with scale factors and time values. Export the second channel as voltages only.</p>	   <table border="1" data-bbox="943 1373 1458 1478"> <thead> <tr> <th>General</th> <th>General</th> <th>General</th> <th>General</th> <th>General</th> <th>General</th> </tr> </thead> <tbody> <tr> <td>199884800</td> <td>233439232</td> <td>264830976</td> <td>292880384</td> <td>321323008</td> <td>3432775</td> </tr> </tbody> </table>	General	General	General	General	General	General	199884800	233439232	264830976	292880384	321323008	3432775
General	General	General	General	General	General									
199884800	233439232	264830976	292880384	321323008	3432775									

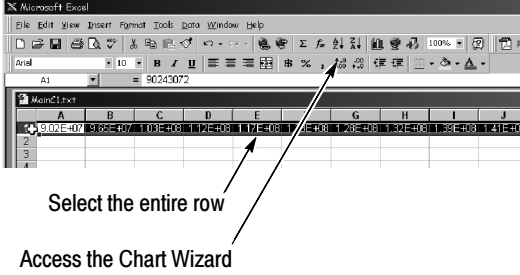
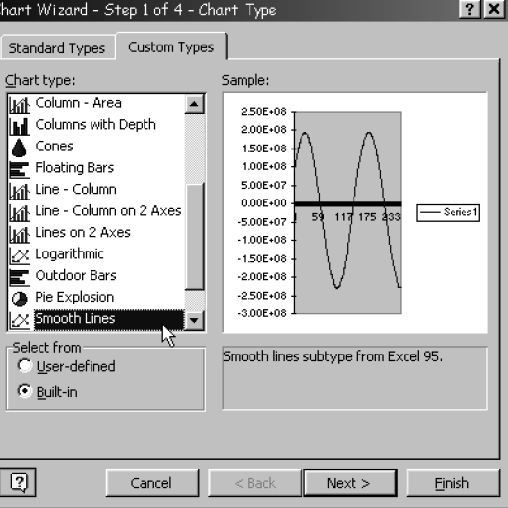
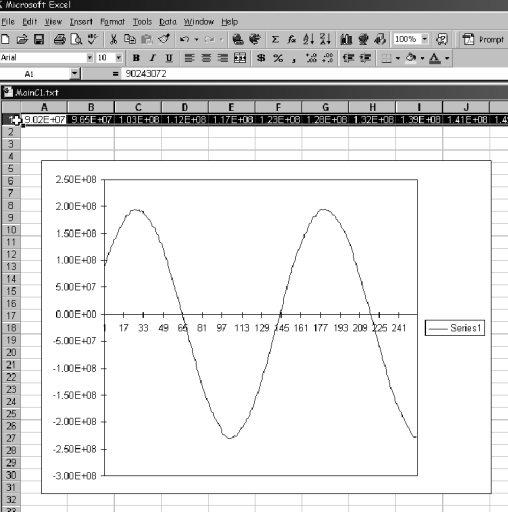
Overview	To use exported waveforms (Cont.)	Control elements and resources
<p>Begin your chart</p>	<p>5. Click on the row number to select the entire row containing your imported waveform values (see right).</p> <p>6. Select the Chart button from the tool bar (see right) or from the Insert menu.</p>	 <p>Select the entire row</p> <p>Access the Chart Wizard</p>
<p>Specify a line-graph chart</p>	<p>7. From the Chart Wizard, make sure Built In is selected. Then select either of the following:</p> <ul style="list-style-type: none"> ■ Lines in the Standards Types tab ■ Smooth lines in the Custom Types tab 	
<p>Finish the chart</p>	<p>8. Click Next to step through the next two steps accepting the defaults setting at each step. Click the Finish button in step 4. You should have a waveform display similar to that show right.</p> <p><i>Note. This procedure assumes MS Excel 97. You can likely specify titles, customize the treatment and labeling of the x and y axes, and so forth in your data-analysis application—either as you create the chart or afterward. Use the help for your data-analysis application to determine if it has these capabilities and for instructions in using them.</i></p>	

Overview	To use exported waveforms (Cont.)	Control elements and resources
<p>For further assistance</p>	<p>9. For more help on exporting waveforms, touch the Help button in the window to access contextual online help.</p>	<div style="text-align: center;">  </div> <p>See page 3-245 to learn about accessing online help.</p>

To Copy Your Waveform Use the procedure that follows to copy a waveform to the clipboard.

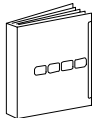
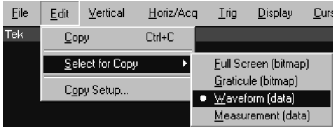
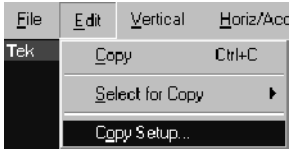
Overview	To save a waveform	Control elements and resources
<p>Prerequisites</p>	<p>1. Make sure the waveform, image, or measurement to be copied exists; that is, your source must be a channel, an active math waveform, an active reference, and so forth.</p>	<div style="text-align: center;">  </div> <ul style="list-style-type: none"> ■ See <i>Powering On the Oscilloscope</i> on page 1-8. ■ See page 3-27 for acquisition setup. ■ See page 3-53 for trigger setup.
<p>Select for copy</p>	<p>2. From the menu bar, select Edit, and then select Select for Copy. See right.</p> <p>The menu lists all available waveform, image, and measurement types available for export:</p> <ul style="list-style-type: none"> ■ Full Screen to export a bitmap of all screen contents ■ Graticule to export a bitmap of only the graticule area ■ Waveform to export waveform data ■ Measurements to export measurement data 	
<p>Select setup for copy</p>	<p>3. From the menu bar, select Edit, and then select Copy Setup to display the Copy Setup control window.</p>	

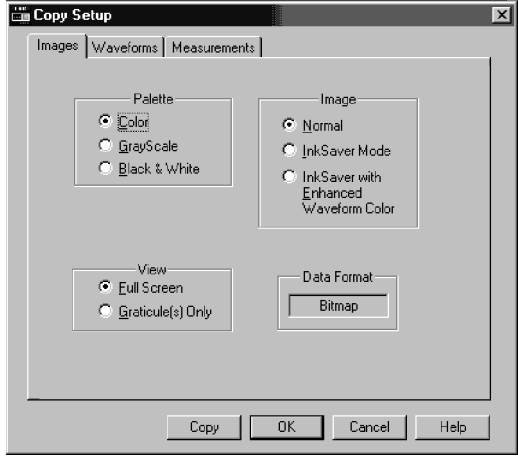
Overview	To save a waveform (Cont.)	Control elements and resources
<p>Setup to copy images</p>	<ol style="list-style-type: none"> 4. Select the Images tab to display the Images control window. 5. In the Palette window, select Color, GrayScale, or Black & White for the color palette of your copied images. 6. In the View window, select whether you want to copy the Full Screen or Graticules Only. 7. In the Image window, select whether you want to copy using Normal or InkSaver Mode. 	 <p>The screenshot shows the 'Copy Setup' dialog box with the 'Images' tab selected. The 'Palette' section has 'Color' selected. The 'Image' section has 'Normal' selected. The 'View' section has 'Full Screen' selected. The 'Data Format' section has 'Bitmap' selected. The 'Copy' button is highlighted.</p>

Setup to copy waveforms

8. Select the Waveforms tab to display the Waveforms control window.

9. Touch Source Waveform, and select the source of the waveform (a channel, math, or reference waveform) to copy from the list.



10. If you want waveform scale factors included in your Mathcad files, click Include waveform scale factors.

11. Touch Data Ordering, and select the data order (top first, bottom first, or rotate) from the list.

12. In the Waveform data range window, select the data to include in the exported files:

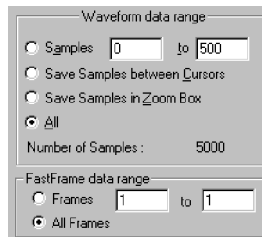
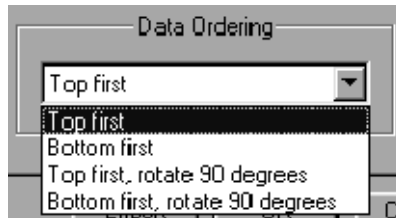
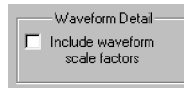
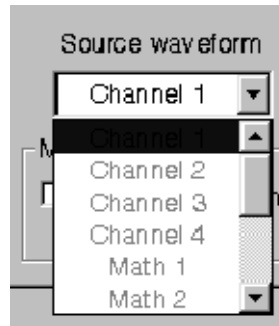
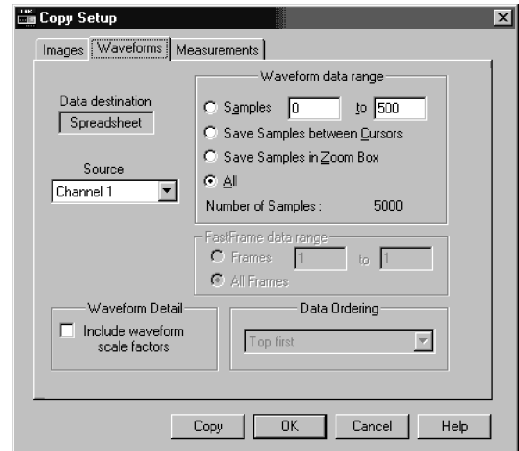
- Samples to enter the data range of the data to include in the exported files
- Save Samples between Cursors to include data between the cursors in the exported files
- Save Samples in Zoom Box to include data in the zoom box in the exported files
- All to include all data in the exported files

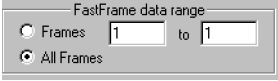
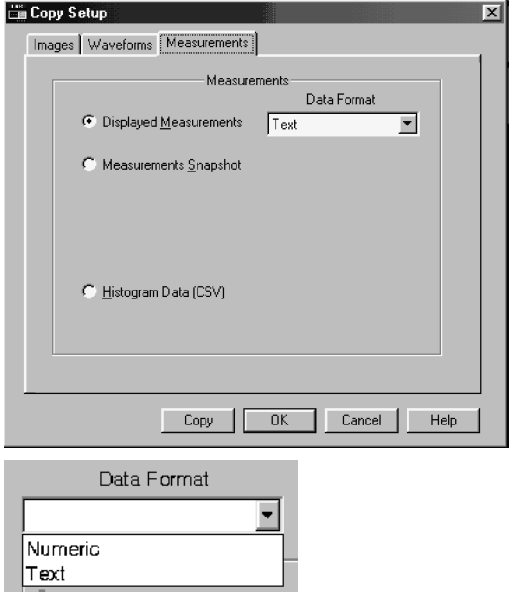
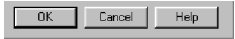

Overview	To save a waveform (Cont.)	Control elements and resources
	<p>13. If using FastFrame, select the frame range to include in the copied files:</p> <ul style="list-style-type: none"> ■ All Frames to include all frames in the copied files ■ Frames to enter a range of frames to include in the copied files 	 <p>A dialog box titled "FastFrame data range" with two radio buttons: "Frames" (with input fields "1" and "1" and a "to" label) and "All Frames" (which is selected).</p>
<p>Setup to copy measurements</p>	<p>14. Select the Measurements tab to display the Measurements control window.</p> <p>15. Select Displayed Measurements to copy measurements that are displayed on screen, or select Measurements Snapshot to copy a snapshot of all measurements.</p> <p>16. Touch Data Format and select the data format (text or numeric) from the list.</p>	 <p>The "Copy Setup" dialog box has tabs for "Images", "Waveforms", and "Measurements". The "Measurements" tab is active, showing "Displayed Measurements" (selected), "Measurements Snapshot", and "Histogram Data (CSV)". A "Data Format" dropdown is set to "Text". Below the dialog is a separate "Data Format" list showing "Numeric" and "Text".</p>
<p>Copy your file</p>	<p>17. Select OK to accept your changes and copy the file to the clipboard, Cancel to close the window without making changes, or Help to access more information.</p>	 <p>A row of three buttons: "OK", "Cancel", and "Help".</p>
<p>For further assistance</p>	<p>18. For more help on copying files, touch the Help button to access contextual online help.</p>	 <p>See page 3-245 to learn about using online help.</p>

Printing Waveforms

You can print the display screen, including any waveforms displayed. Before you can print, you must install and set up your printer. Consult the instructions that come with your printer. Also for printer setup instructions, you can display Windows help and access its section on printers.

To Print from Front Panel

To print a waveform from the front panel, push the front-panel PRINT button. The display screen will print on the default printer. For additional print options, see the topics that follow.

To Print from Menu Bar

To print a waveform, from the application menu bar, select the File menu, and then select Print. The oscilloscope displays the standard MS Windows 98 Print window shown in Figure 3-60. Access the windows help system for more information.

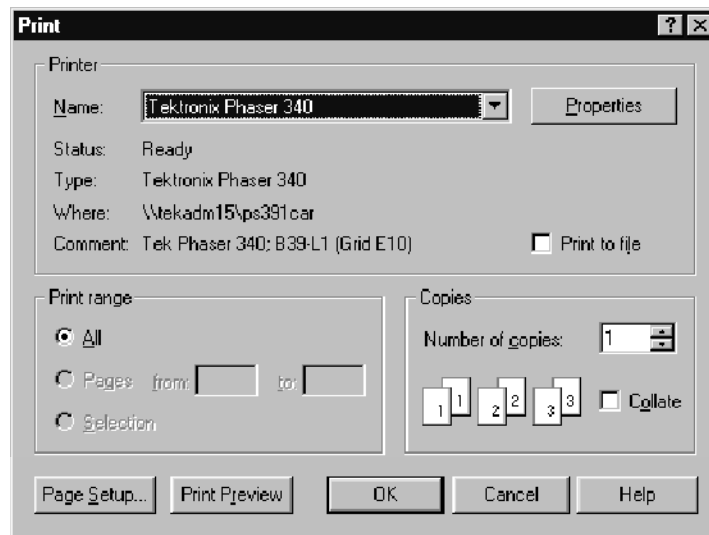

Figure 3-60: Print window

To Set Up the Page

To set the format of the printed page, from the application menu bar, select the File menu, and then select Page Setup. The oscilloscope displays the Page Setup window shown in Figure 3-62.

- **Paper:** select the paper size and source from the drop down lists.
- **Orientation:** select either Portrait or Landscape (see Figure 3-61).
- **Margins:** set the margins you want for your page.

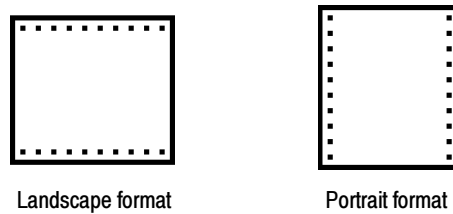

Figure 3-61: Hardcopy formats

- **Palette:** select either Color, GrayScale, or Black & White.
- **View:** select either Full-Screen or Graticule(s) Only:
 - Full-Screen displays both the graticule and menu areas of the screen
 - Graticule(s) displays only the graticule area of the display
- **Image:** select either Normal, InkSaver, or InkSaver with Enhanced Waveform Color Mode.
 - Normal exports the image exactly as it appears on-screen
 - InkSaver exports the image with a white background to save ink when printing waveforms
 - InkSaver with Enhanced Waveform Color exports the image with colors designed to print with the white background

Touch Help for more information.

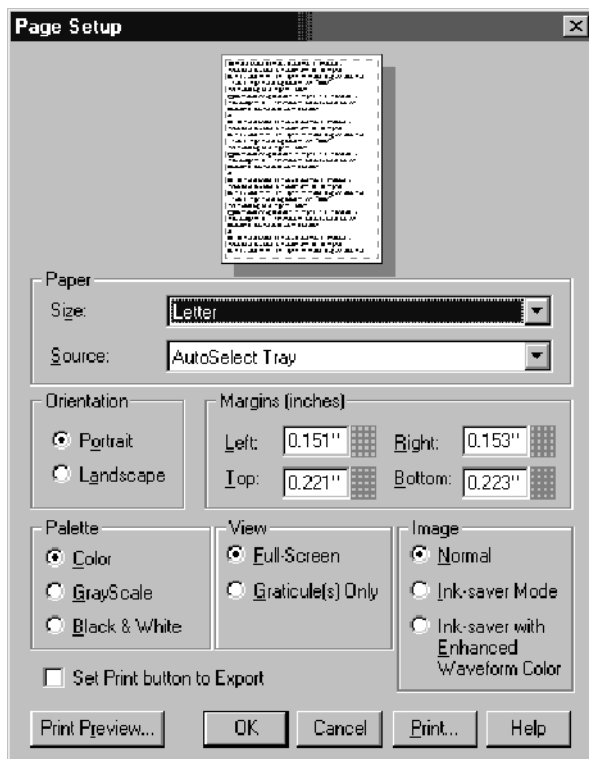

Figure 3-62: Page setup window

To Preview the Page

To preview your printout, from the application menu bar, select the File menu, and then select Print Preview. The oscilloscope displays the standard MS Windows 98 Print Preview window shown in Figure 3-63. Access the windows help system for more information.

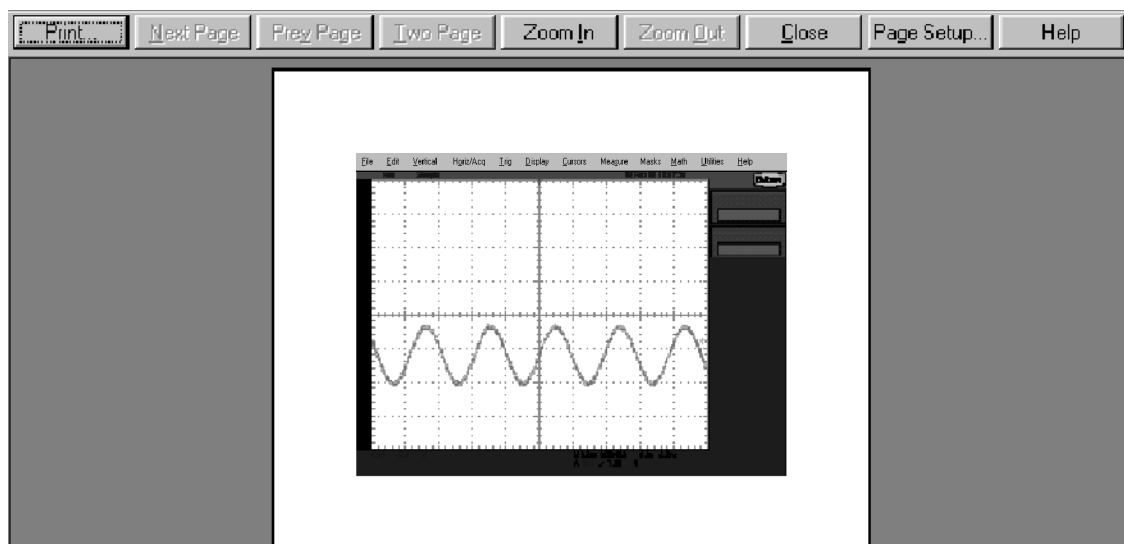

Figure 3-63: Print preview window

To Print Using Print Screen





Pressing the Windows Print Screen key copies the currently displayed bitmap to the clipboard. This bitmap does not include the oscilloscope waveforms or graticule. The waveforms and graticule are displayed by the graphics adapter outside of normal Windows mechanisms.

The graphics adapter uses a technique similar to that used by TV weathermen. They stand in front of a blank (blue) screen that is electronically replaced by a weather map. The oscilloscope uses a blank (dark gray) image that is electronically replaced by the graticule and the waveforms that are currently being displayed. If you load the bitmap into a program such as Paint, the graticule and waveforms are not part of the bitmap, and, although they are visible on Paint's window, they will not be saved or printed.

To capture the oscilloscope screen with its graticule and waveform, either use Copy in the Edit menu after selecting Image in the Copy Setup menu, or if you want to build a bitmap file, just select Export in the File menu after selecting Full Screen (bitmap) in the Select for Export menu. For additional information see *Exporting and Copying Waveforms* on page 3-223.

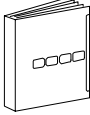
**To Date/Time Stamp
Hardcopies**

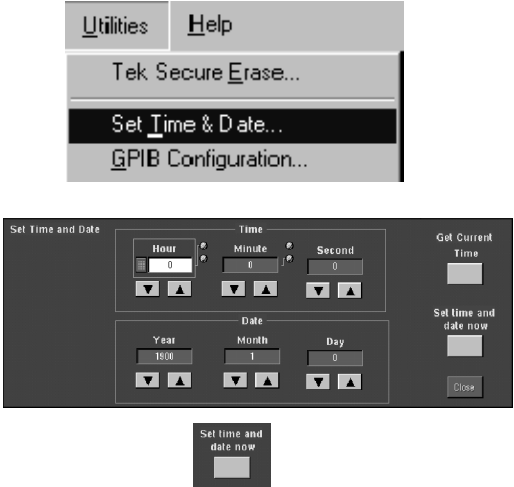
You can display the current date and time on screen so that they appear on hardcopies you print. To date and time stamp your hardcopy, do the following steps:

Overview	To date/time stamp hardcopies	Control elements and resources
<p>Prerequisites</p>	<p>1. The oscilloscope must be powered on.</p>	 <p>See <i>Powering On the Oscilloscope</i> on page 1-8.</p>
<p>To display the date and time</p>	<p>2. From the tool bar, touch Disp and select the Objects tab. 3. Touch Display Date/Time to toggle it on.</p>	
<p>To set the date and time</p>	<p>4. From the menu bar, touch Utilities and select Set Time & Date to display the Set Time and Date control window. 5. Touch Hour, Minute, or Second and use the multipurpose knobs, keypad, or arrow buttons to enter the time. 6. Touch Year, Month, or Day and use the multipurpose knobs, keypad, or arrow buttons to enter the date. 7. Touch Set time and date now to set the time and date.</p>	
<p>To get the current time</p>	<p>8. Touch Get Current Time to get the current time from the Windows operating system.</p>	

Remote Communication

Remote communication is performed through the GPIB interface. Consult the online Programmer Guide for help with establishing remote communication and control of the oscilloscope.

To access the Programmer Guide, locate the Product Software CD that was shipped with the oscilloscope. Install the CD in the personal computer that you want to use, typically your oscilloscope controller. Follow the directions in the CD booklet.

You can install the guide in the oscilloscope, but that may not be convenient because it will cover the oscilloscope screen.

For information on connecting the oscilloscope to a network to enable printing, file sharing, internet access, and other communications functions, see *Connecting to a Network* on page 1-14.

Accessing Online Help

This manual represents only part of the user assistance available to you — the online help system, integrated as part of the oscilloscope user interface, provides quick-to-access support for operating this oscilloscope. This section describes the help system and how to access it.

This oscilloscope provides the following help resources online:

- Help Topics
- Programmers Guide

Much of the information you need to operate this oscilloscope and use it effectively is found online, where you can quickly access it and display it on your oscilloscope screen. You need to access the online documentation for most operating information.

A few keys to remember when using online help follow:



- Use online help when you want to minimize interruption to your work flow. Help Topics are there when you need to probe more deeply into feature operation.
- Use the manuals for instructions on putting the oscilloscope into service, for procedures on reinstalling its product software, for listings of specifications, and for overviews of features and their operation.
- Use the online programmers guide, either displayed on the oscilloscope screen, or on your windows-equipped PC, for support on operating the oscilloscope from the GPIB.

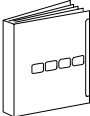

How to Use Online Help

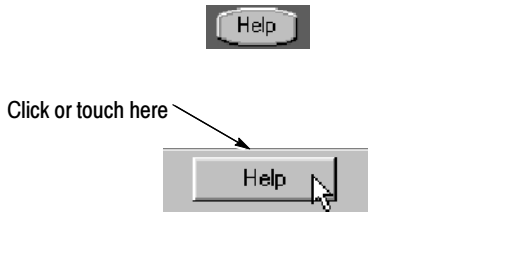
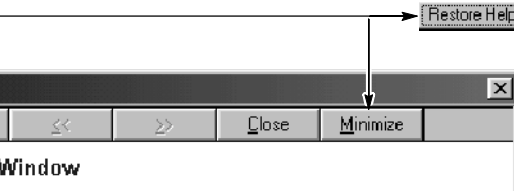
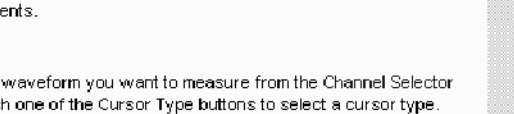
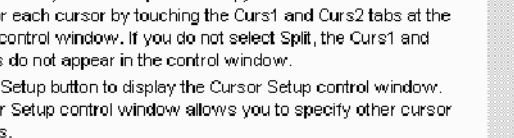
Use the procedure steps that follow to access contextual help and to learn how to search the help system for more information.

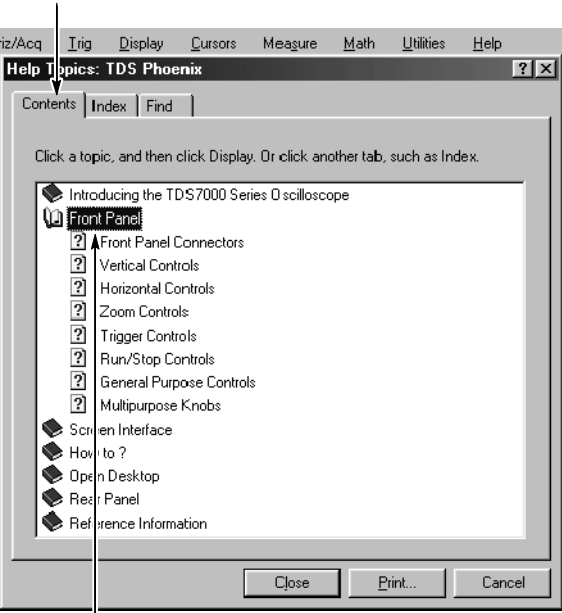
Overview	To use online help	Control elements & resources
Prerequisites	1. The oscilloscope must be powered up and running.	 <ul style="list-style-type: none">■ See <i>Installation</i>, page 1-5.

Overview	To use online help	Control elements & resources
<p>For in-depth, contextual overviews</p>	<ol style="list-style-type: none"> When using the tool bar and you have a control window displayed, touch the Help button to open the help system with an overview of the control window that is currently displayed. Some windows have a help button as shown at the right. Just click the button to open the help system with an overview of the dialog box that is currently displayed. See below. 	
<p>Touch the Minimize button in a help window to move help out of the way so you can operate the oscilloscope. Touch the Restore Help button to see the last help topic again.</p>		
<p>Touch a tab in a help window to navigate between the Overview and specific topics.</p>		
<p>Touch an outlined control shown in the help window to receive more specific information about the control.</p>		

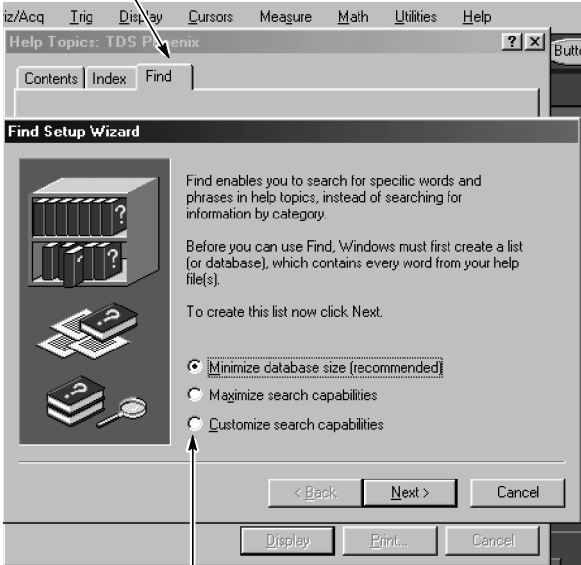
Overview	To use online help	Control elements & resources
<p>To dig deeper</p>	<p>4. You can search for help using methods that most users of PCs are familiar with: From the menu bar, select Help, and then select Contents and Index. See right.</p> <p>5. From the online help finder (see below), choose from the three tabs.</p>  <p>6. Click to explore the topic titles and to highlight one for display. Click the Display button to open the topic in a help window.</p>	

Overview	To use online help	Control elements & resources
<p>To enable full-text search</p>	<p>7. If you cannot find the information in the Contents or Index tabs of the online finder, you may want to enable full text search: From the application menu bar, select Help, and then select Contents and Index. See right.</p> <p>8. From the online help finder (see below), choose the Find tab.</p>  <p>9. Choose the method for word list generation and select next or finish. Once the word list generation finishes, clicking the Find tab will access a pane for searching with full text search.</p>	

Appendix A: Specifications

This chapter contains the specifications for the TDS7000 series Digital Phosphor Oscilloscopes. All specifications are guaranteed unless labeled “typical.” Typical specifications are provided for your convenience but are not guaranteed. Specifications that are marked with the ✓ symbol are checked in chapter four, *Performance Verification*.

All specifications apply to all TDS7000 models unless noted otherwise. To meet specifications, the following conditions must be met:

- The oscilloscope must have been calibrated in an ambient temperature between 20 °C and 30 °C.
- The oscilloscope must be operating within the environmental limits listed in Table A-10.
- The oscilloscope must be powered from a source that meets the specifications listed in Table A-8 on page A-19.
- The oscilloscope must have been operating continuously for at least 20 minutes within the specified operating temperature range.
- You must perform the Signal Path Compensation procedure after the 20-minute warm-up period, and if the ambient temperature changes more than 5 °C, repeat the procedure. See *Optimizing Measurement Accuracy* on page 3-141 for instructions to perform this procedure.

Product and Feature Description

The TDS7000 series Digital Phosphor Oscilloscope family consists of the models shown in Table A-1.

Table A- 1: TDS7000 models

Model	Number of channels	Bandwidth	Maximum sample rate (real time)
TDS7054	4	500 MHz	5 GS/s
TDS7104	4	1 GHz	10 GS/s

Acquisition Features

Separate Digitizers. Ensure accurate timing measurements with separate digitizers for each channel. Acquisition on multiple channels is always concurrent. The digitizers can also be combined to yield a higher sample rate on a single channel.

Fast Acquisition. Acquire up to 200,000 waveforms per second to see rapidly changing signals or intermittent signal irregularities.

Long Record Lengths. Choose record lengths from 500 points to up to 100,000 points per channel (up 400,000 points on a single channel). Extend the maximum record length up to a maximum of 16,000,000 points with memory options.

Peak Detect Acquisition Mode. See pulses as narrow as 400 ps even at the slower time base settings. Peak detect helps you see noise and glitches in your signal.

Acquisition Control. Acquire continuously or set up to capture single shot acquisitions. Enable or disable optional acquisition features such as equivalent time or roll mode. Use Fast Frame acquisition to capture and time stamp many events in a rapid sequence.

Horizontal Delay. Use delay when you want to acquire a signal at a significant time interval after the trigger point. Toggle delay on and off to quickly compare the signal at two different points in time.

Signal Processing Features

Average, Envelope, and Hi Res Acquisition. Use Average acquisition mode to remove uncorrelated noise from your signal. Use Envelope to capture and display the maximum variation of the signal. Use Hi Res to increase vertical resolution for lower bandwidth signals.

Waveform Math. Set up simple math waveforms using the basic arithmetic functions or create more advanced math waveforms using the math expression editor. Waveform expressions can even contain measurement results and other math waveforms.

Spectral Analysis. Display spectral magnitude and phase waveforms based on your time-domain acquisitions. Control the oscilloscope using the traditional spectrum analyzer controls such as span and center frequency.

Display Features	Color LCD Display. Identify and differentiate waveforms easily with color coding. Waveforms, readouts, and inputs are color matched to increase productivity and reduce operating errors. Enhance visualization of waveforms with color grading.
	Digital Phosphor. A Digital Phosphor Oscilloscope can clearly display intensity modulation in your signals. The oscilloscope automatically overlays subsequent acquisitions and then decays them to simulate the writing and decay of the phosphor in an analog oscilloscope CRT. The feature results in an intensity-graded or color-graded waveform display that shows the information in the intensity modulation.
	Fit to Screen. The Digital Phosphor technology performs the compression required to represent all record points on the screen, even at the maximum record length settings.
	Zoom. To take advantage of the full resolution of the oscilloscope you can zoom in on a waveform to see the fine details. Both vertical and horizontal zoom functions are available.
Measurement Features	Cursors. Use cursors to take simple voltage, time, and frequency measurements.
	Automatic Measurements. Choose from a large palette of amplitude, time, and histogram measurements. You can customize the measurements by changing reference levels or by adding measurement gating.
	Mask Testing. Option SM only. Provides mask testing for verifying compliance to standards.
Trigger Features	Simple and Advanced Trigger Types. Choose simple edge trigger or choose from eight advanced trigger types to help you capture a specific signal fault or event.
	Dual Triggers. Use the A (main) trigger system alone or add the B trigger to capture more complex events. You can use the A and B triggers together to set up a delay-by-time or delay-by-events trigger condition.
	Comm Triggers. Option SM only. Use comm triggers to trigger on communication signals.
Convenience Features	Autoset. Use Autoset to quickly set up the vertical, horizontal, and trigger controls for a usable display. If a standard mask is active (Option SM only), Autoset adjusts the selected waveform to match the mask, if possible.

Touch Screen Interface. You can operate all oscilloscope functions (except the power switch) from the touch screen interface. If convenient, you can also install a mouse and keyboard to use the interface.

Toolbar or Menu Bar. You can choose a toolbar operating mode that is optimized for use with the touch screen, or a PC-style menu-bar operating mode that is optimized for use with a mouse.

Open Desktop. The oscilloscope is built on a Microsoft Windows software platform; the oscilloscope application program starts automatically when you apply power to the instrument. You can minimize the oscilloscope application and take full advantage of the built-in PC to run other applications. Moving waveform images and data into other applications is as simple as a copy/paste operation.

Dedicated Front Panel Controls. The front panel contains knobs and buttons to provide immediate access to the most common oscilloscope controls. Separate vertical controls are provided for each channel. The same functions are also available through the screen interface.

Data Storage and I/O. The oscilloscope has a removeable hard disk drive, a CD-RW drive, and a floppy disk drive that can be used for storage and retrieval of data. The oscilloscope has GPIB, USB, Centronics, COM, and Ethernet ports for input and output to other devices.

Online Help. The oscilloscope has a complete online help system that covers all its features. The help system is context sensitive; help for the displayed control window is automatically shown if you touch the help button. Graphical aids in the help windows assist you in getting to the information you need. You can also access the help topics through a table of contents or index.

Specification Tables

Table A-2: Channel input and vertical specifications

Characteristic	Description
Input coupling	DC, AC, and GND Channel input is disconnected from input termination when using GND coupling.
Input channels	Four, all identical

Table A-2: Channel input and vertical specifications (Cont.)

Characteristic	Description										
Input impedance, DC coupled	1 M Ω \pm 0.5% in parallel with 10 pF (\pm 3 pF) 50 Ω \pm 1%; VSWR \leq 1.3:1 from DC to 500 MHz, \leq 1.5:1 from 500 MHz to 1 GHz										
Maximum voltage at input BNC (1 M Ω)	150 V _{RMS} CAT I, For steady state sinusoidal waveforms, derate at 20 dB/decade above 200 kHz to 9 V _{RMS} at 3 MHz and above										
Maximum voltage at input BNC (50 Ω)	5 V _{RMS} , with peaks \leq \pm 30 V										
✓ Differential delay at input BNC	\leq 50 ps between any two channels with the same scale and coupling settings										
✓ Channel-to-channel crosstalk	\geq 100:1 at 100 MHz, and \geq 30:1 at the rated bandwidth for any two channels with the same scale and coupling settings										
Digitizers	8-bit resolution, separate digitizers for each channel sample simultaneously										
Sensitivity range	1 M Ω : 1 mV/div to 10 V/div, in a 1-2-5 sequence 50 Ω : 1 mV/div to 1 V/div, in a 1-2-5 sequence Fine adjustment available with \geq 1% resolution										
✓ Analog bandwidth	DC 50 Ω coupling, bandwidth limit set to Full, operating ambient \leq 30 $^{\circ}$ C, derated by 2.5 MHz/ $^{\circ}$ C above 30 $^{\circ}$ C <table border="1" data-bbox="915 1226 1505 1646"> <thead> <tr> <th>SCALE range</th> <th>Bandwidth</th> </tr> </thead> <tbody> <tr> <td>1 mV/div to 1.99 mV/div</td> <td>TDS7054: DC to 450 MHz TDS7104: DC to 500 MHz</td> </tr> <tr> <td>2 mV/div to 4.98 mV/div</td> <td>TDS7054: DC to 500 MHz TDS7104: DC to 600 MHz</td> </tr> <tr> <td>5 mV/div to 9.95 mV/div</td> <td>TDS7054: DC to 500 MHz TDS7104: DC to 750 MHz</td> </tr> <tr> <td>10 mV/div to 1 V/div</td> <td>TDS7054: DC to 500 MHz TDS7104: DC to 1 GHz</td> </tr> </tbody> </table>	SCALE range	Bandwidth	1 mV/div to 1.99 mV/div	TDS7054: DC to 450 MHz TDS7104: DC to 500 MHz	2 mV/div to 4.98 mV/div	TDS7054: DC to 500 MHz TDS7104: DC to 600 MHz	5 mV/div to 9.95 mV/div	TDS7054: DC to 500 MHz TDS7104: DC to 750 MHz	10 mV/div to 1 V/div	TDS7054: DC to 500 MHz TDS7104: DC to 1 GHz
SCALE range	Bandwidth										
1 mV/div to 1.99 mV/div	TDS7054: DC to 450 MHz TDS7104: DC to 500 MHz										
2 mV/div to 4.98 mV/div	TDS7054: DC to 500 MHz TDS7104: DC to 600 MHz										
5 mV/div to 9.95 mV/div	TDS7054: DC to 500 MHz TDS7104: DC to 750 MHz										
10 mV/div to 1 V/div	TDS7054: DC to 500 MHz TDS7104: DC to 1 GHz										
Analog bandwidth limit, typical	Selectable between 20 MHz, 200 MHz, or Full										
Lower frequency limit, AC coupled	< 10 Hz for 1 M Ω , reduced by a factor of ten when using a 10X probe; < 200 kHz for 50 Ω										

Table A-2: Channel input and vertical specifications (Cont.)

Characteristic	Description	
Calculated rise time, typical	DC 50 Ω coupling, bandwidth limit set to Full	
	<i>SCALE range</i>	<i>Rise time</i>
	1 mV/div to 1.99 mV/div	TDS7054: 890 ps TDS7104: 800 ps
	2 mV/div to 4.98 mV/div	TDS7054: 800 ps TDS7104: 600 ps
	5 mV/div to 9.95 mV/div	TDS7054: 800 ps TDS7104: 530 ps
	10 mV/div to 1 V/div	TDS7054: 800 ps TDS7104: 400 ps
Step response settling errors, typical	Bandwidth limit set to Full	
	<i>SCALE range and step amplitude</i>	<i>Settling error at time after step</i>
	1 mV/div to 100 mV/div, with ≤ 2 V step	20 ns: $\leq 0.5\%$ 100 ns: $\leq 0.2\%$ 20 ms: $\leq 0.1\%$
	101 mV/div to 1 V/div, with ≤ 20 V step	20 ns: $\leq 1.0\%$ 100 ns: $\leq 0.5\%$ 20 ms: $\leq 0.2\%$
	1.01 V/div to 10 V/div, with ≤ 200 V step	20 ns: $\leq 1.0\%$ 100 ns: $\leq 0.5\%$ 20 ms: $\leq 0.2\%$

Table A-2: Channel input and vertical specifications (Cont.)

Characteristic	Description	
Position range	± 5 divisions	
Offset range	<i>SCALE range</i>	<i>Offset range</i>
	1 mV/div to 100 mV/div	±1 V
	101 mV/div to 1 V/div	±10 V
	1.01 V/div to 10 V/div	±100 V
Offset accuracy	<i>SCALE range</i>	<i>Offset range</i>
	1 mV/div to 100 mV/div	$\pm(0.2\% \times \text{net offset} + 1.5 \text{ mV} + (0.1 \text{ div} \times \text{V/div setting}))$
	101 mV/div to 1 V/div	$\pm(0.25\% \times \text{net offset} + 15 \text{ mV} + (0.1 \text{ div} \times \text{V/div setting}))$
	1.01 V/div to 10 V/div	$\pm(0.25\% \times \text{net offset} + 150 \text{ mV} + (0.1 \text{ div} \times \text{V/div setting}))$
<i>where, net offset = offset - (position × volts/division)</i>		
DC gain accuracy,	±1% in Sample or Average acquisition mode	
DC voltage measurement accuracy	<i>Measurement type</i>	<i>DC accuracy (in volts)</i>
	Sample acquisition mode, typical	<p>Absolute measurement of any waveform point, and High, Low, Max, and Min measurements</p> <p>Delta voltage measurement between any two points acquired under the same setup and ambient conditions, and all other automatic measurements</p> <p><i>where, net offset = offset - (position × volts/division)</i></p>
✓ Average acquisition mode (≥16 averages)	Absolute measurement of any waveform point, and High, Low, Max, and Min measurements	$\pm[(1.0\% \times \text{reading} - \text{net offset}) + \text{offset accuracy} + (0.06 \times \text{V/div})]$
	Delta voltage measurement between any two points acquired under the same setup and ambient conditions, and all other automatic measurements	$\pm[(1.0\% \times \text{reading}) + (0.1 \text{ div} \times \text{V/div setting}) + 0.3 \text{ mV}]$
<i>where, net offset = offset - (position × volts/division)</i>		

Table A-2: Channel input and vertical specifications (Cont.)

Characteristic	Description	
Nonlinearity, typical	< 1 LSB differential, < 1 LSB integral, independently based	
Effective bits, typical	Sine wave input at the indicated frequency and pk-pk amplitude, at 50 mV/division and 25 °C	
	<i>Signal and input conditions</i>	<i>Effective bits</i>
TDS7054	1 MHz, 9.2 div, 2 GS/s sample rate, Sample acquisition mode	6.8 bits
	1 MHz, 9.2 div, 10 MS/s sample rate, HiRes acquisition mode	8.7 bits
	500 MHz, 6.5 div, 2 GS/s sample rate, Sample acquisition mode	6.8 bits
TDS7104	1 MHz, 9.2 div, 10 GS/s sample rate, Sample acquisition mode	6.6 bits
	1 MHz, 9.2 div, 10 MS/s sample rate, HiRes acquisition mode	8.7 bits
	1 GHz, 6.5 div, 10 GS/s sample rate, Sample acquisition mode	5.5 bits

Table A-3: Horizontal and acquisition system specifications

Characteristic	Description	
Acquisition modes	Sample, Peak detect, Hi Res, Average, Envelope, and Waveform database	
Acquisition rate	up to 200,000 waveforms per second in Fast Acquisition mode up to 130 waveforms per second with Fast Acquisition off	
Minimum record length	500 points	
Maximum record length	Depends on the number of active channels and the amount of memory installed	
Standard	100,000 points (3 or 4 channels) 200,000 points (1 or 2 channels only) 400,000 points (1 channel only)	
Option 1M installed	500,000 points (3 or 4 channels) 1,000,000 points (1 or 2 channels only) 2,000,000 points (1 channel only)	
Option 2M installed	2,000,000 points (3 or 4 channels) 4,000,000 points (1 or 2 channels only) 8,000,000 points (1 channel only)	
Option 3M installed	4,000,000 points (3 or 4 channels) 8,000,000 points (1 or 2 channels only) 16,000,000 points (1 channel only)	
Real-time sample rate range	<i>Number of channels acquired</i>	<i>Sample rate range</i>
TDS7054	1	1.25 S/s to 5 GS/s
	2	1.25 S/s to 5 GS/s
	3 or 4	1.25 S/s to 2.5 GS/s
TDS7104	1	1.25 S/s to 10 GS/s
	2	1.25 S/s to 5 GS/s
	3 or 4	1.25 S/s to 2.5 GS/s
Equivalent-time sample rate or interpolated waveform rate range	5 GS/s to 250 GS/s Equivalent-time acquisition can be enabled or disabled. When disabled, waveforms are interpolated at the fastest time base settings.	
Seconds/division range	200 ps/div to 40 s/div	
Horizontal delay range	0 s to 1000 s	

Table A-3: Horizontal and acquisition system specifications (Cont.)

Characteristic	Description						
✓ Long term sample rate and delay time accuracy	± 15 ppm over any ≥ 1 ms interval						
RMS aperture uncertainty, typical	$\leq [3 \text{ ps} + (0.1 \text{ ppm} \times \text{record duration})]$						
✓ Delta time measurement accuracy	For a single channel, with signal amplitude > 5 div, reference level set at 50%, interpolation set to $\sin(x)/x$, volts/division set to ≥ 5 mV/div, with (displayed risetime)/(sample interval) ratio between 1.4 and 4, where sample interval = $1/(\text{real-time sample rate})$						
	<table border="1"> <thead> <tr> <th>Conditions</th> <th>Accuracy</th> </tr> </thead> <tbody> <tr> <td>Single shot signal, Sample or Hi Res acquisition mode, Full bandwidth</td> <td>$\pm (15 \text{ ppm} \times \text{reading} + 0.3 \text{ sample intervals})$</td> </tr> <tr> <td>Average acquisition mode, ≥ 100 averages, Full bandwidth</td> <td>$\pm (15 \text{ ppm} \times \text{reading} + 20 \text{ ps})$</td> </tr> </tbody> </table>	Conditions	Accuracy	Single shot signal, Sample or Hi Res acquisition mode, Full bandwidth	$\pm (15 \text{ ppm} \times \text{reading} + 0.3 \text{ sample intervals})$	Average acquisition mode, ≥ 100 averages, Full bandwidth	$\pm (15 \text{ ppm} \times \text{reading} + 20 \text{ ps})$
Conditions	Accuracy						
Single shot signal, Sample or Hi Res acquisition mode, Full bandwidth	$\pm (15 \text{ ppm} \times \text{reading} + 0.3 \text{ sample intervals})$						
Average acquisition mode, ≥ 100 averages, Full bandwidth	$\pm (15 \text{ ppm} \times \text{reading} + 20 \text{ ps})$						

Table A-3: Horizontal and acquisition system specifications (Cont.)

Characteristic	Description	
Maximum Fast Frame update rate, typical	160,000 frames per second	
Frame length and maximum number of frames	Maximum number of frames for Sample or Peak Detect acquisition mode, depending on memory option installed	
	<i>Frame length</i>	<i>Maximum number of frames</i>
	50 points	Standard: 181 Option 1M: 909 Option 2M: 3636 Option 3M: 7272
	250 points	Standard: 133 Option 1M: 666 Option 2M: 2666 Option 3M: 5333
	500 points	Standard: 100 Option 1M: 500 Option 2M: 2000 Option 3M: 4000
	2500 points	Standard: 33 Option 1M: 166 Option 2M: 666 Option 3M: 1333
	5000 points	Standard: 18 Option 1M: 90 Option 2M: 363 Option 3M: 727
	25,000 points	Standard: 3 Option 1M: 19 Option 2M: 78 Option 3M: 156
	50,000 points	Standard: 1 Option 1M: 9 Option 2M: 39 Option 3M: 79
	100,000 points	Standard: — Option 1M: 4 Option 2M: 19 Option 3M: 39
	250,000 points	Standard: — Option 1M: 1 Option 2M: 7 Option 3M: 15

Table A-3: Horizontal and acquisition system specifications (Cont.)

Characteristic	Description	
	<i>Frame length</i>	<i>Maximum number of frames</i>
	500,000 points	Standard: — Option 1M: — Option 2M: 3 Option 3M: 7
	1,000,000 points	Standard: — Option 1M: — Option 2M: 1 Option 3M: 3
	2,000,000 points	Standard: — Option 1M: — Option 2M: — Option 3M: 1

Table A- 4: Trigger specifications

Characteristic	Description	
Auxiliary trigger input resistance, typical	$\geq 1.5 \text{ k}\Omega$	
Maximum trigger input voltage, typical	$\pm 20 \text{ V}$ (DC or peak AC)	
✓ Edge Trigger Sensitivity	<i>Trigger Source</i>	<i>Sensitivity</i>
TDS7054	Any channel, DC coupled	0.35 div from DC to 50 MHz, increasing to 1 div at 500 MHz
	Auxiliary input	400 mV from DC to 50 MHz, increasing to 750 mV at 100 MHz
TDS7104	Any channel, DC coupled	0.35 div from DC to 50 MHz, increasing to 1 div at 1 GHz
	Auxiliary input	250 mV from DC to 50 MHz, increasing to 500 mV at 100 MHz
Edge trigger sensitivity, typical	All sources, for vertical scale settings $\geq 10 \text{ mV/div}$ and $\leq 1 \text{ V/div}$	
	<i>Trigger coupling</i>	<i>Sensitivity</i>
	NOISE REJ	$3 \times$ the DC-coupled limits
	AC	Same as DC-coupled limits for frequencies $\geq 60 \text{ Hz}$, attenuates signals $< 60 \text{ Hz}$
	HF REJ	$1.5 \times$ the DC-coupled limits from DC to 30 kHz, attenuates signals $> 30 \text{ kHz}$
	LF REJ	$1.5 \times$ the DC-coupled limits for frequencies $\geq 80 \text{ kHz}$, attenuates signals $< 80 \text{ kHz}$
Advanced trigger sensitivity, typical	For all trigger types except Edge, with vertical scale settings $\geq 10 \text{ mV/div}$ and $\leq 1 \text{ V/div}$ 1.0 div, from DC to 500 MHz	
Event count sensitivity, typical	For sequential trigger delayed by events, with vertical scale settings $\geq 10 \text{ mV/div}$ and $\leq 1 \text{ V/div}$ 1.0 div, from DC to 500 MHz	

Table A-4: Trigger specifications (Cont.)

Characteristic	Description	
Trigger level or threshold range	<i>Trigger Source</i>	<i>Sensitivity</i>
	Any channel	±12 divisions from center of screen
	Auxiliary input	±8 V
	Line	±400 V
Trigger level or threshold accuracy, typical	Edge trigger, DC coupling, for signals having rise and fall times ≤20 ns	
	<i>Trigger Source</i>	<i>Accuracy</i>
	Any channel	± [(2% × setting - net offset) + (0.3 div × volts/div setting) + offset accuracy]
	Auxiliary	Not calibrated or specified
	<i>where, net offset = offset - (position × volts/division)</i>	
Set level to 50% function	Operates with signals ≥30 Hz	
Trigger position error, typical	Edge trigger, DC coupling, for signals having a slew rate at the trigger point of ≥ 0.5 div/ns	
	<i>Acquisition mode</i>	<i>Error</i>
	Sample, Average	± (1 displayed point + 1ns)
	Envelope	± (2 displayed points + 1ns)
Trigger jitter, typical	σ = 8 ps	
B Event (Delayed) trigger	<i>Trigger After Time</i>	<i>Trigger on nth Event</i>
	Range	Delay time = 16 ns to 250 s Event count = 1 to 10 ⁷
	Minimum time between arm (A Event) and trigger (B Event), typical	2 ns from the end of the time period to the B trigger event 2 ns between the A trigger event and the first B trigger event
	Minimum pulse width, typical	— B event width ≥1 ns
	Maximum frequency, typical	— B event frequency ≤500 MHz

Table A- 4: Trigger specifications (Cont.)

Characteristic	Description	
Advanced trigger timing	For vertical scale settings ≥ 10 mV/div and ≤ 1 V/div	
	<i>Minimum recognizable event width or time</i>	<i>Minimum re-arm time to recognize next event</i>
Glitch type	Minimum glitch width = 1 ns	2 ns + 5% of glitch width setting
Runt type	Minimum runt width = 2 ns	2 ns
Runt type	Minimum runt width = 2 ns	8.5 ns + 5% of runt width setting
Width type	Minimum difference between upper and lower limits = 1 ns	2 ns + 5% of upper limit setting
Timeout type	Minimum timeout time = 1 ns	2 ns + 5% of timeout setting
Transition type	Minimum transition time = 600 ps	8.5 ns + 5% of transition time setting
Pattern type, typical	Minimum time the pattern is true = 1 ns	1 ns
State type, typical	Minimum true time before clock edge = 1 ns	1 ns
	Minimum true time after clock edge = 1 ns	
Setup/Hold type, typical	<i>Minimum clock pulse width from active edge to inactive edge</i>	<i>Minimum clock pulse width from inactive edge to active edge</i>
	3 ns + hold time setting	2 ns
	<i>Setup and Hold parameters</i>	<i>Limits</i>
	Setup time (time from data transition to clock edge)	-100 ns minimum +100 ns maximum
	Hold time (time from clock edge to data transition)	-1 ns minimum +100 ns maximum
	Setup time + Hold time (algebraic sum of the two settings)	+2 ns minimum +200 ns maximum

Table A-4: Trigger specifications (Cont.)

Characteristic	Description	
Advanced trigger timer ranges	<i>Limits</i>	
Glitch type	1 ns to 1 s	
Runt type, time qualified	1 ns to 1 s	
Width type	1 ns to 1 s	
Timeout type	1 ns to 1 s	
Transition type	1 ns to 1 s	
Pattern type	1 ns to 1 s	
Setup/Hold type	<i>Setup and Hold timers</i>	<i>Limits</i>
	Setup time (time from data transition to clock edge)	-100 ns to +100 ns
	Hold time (time from clock edge to data transition)	-1 ns to +100 ns
	Setup time + Hold time (algebraic sum of the two settings)	+2 ns to +200 ns
✓ Advanced trigger timer accuracy	For Glitch, Timeout, or Width types	
	<i>Time range</i>	<i>Accuracy</i>
	1 ns to 500 ns	±(20% of setting + 0.5 ns)
	520 ns to 1 s	±(0.01% of setting + 100 ns)
Trigger holdoff range	250 ns to 12 s, minimum resolution is 8 ns for settings ≤1.2 ms	

Table A-5: Display specifications

Characteristic	Description
Display type	211.2 mm (W) × 158.4 mm (H), 264 mm (10.4 in) diagonal, liquid crystal active-matrix color display
Display resolution	640 horizontal × 480 vertical pixels
Pixel pitch	0.33 mm horizontal, 0.22 mm vertical
Contrast ratio, typical	150:1
Response time, typical	50 ms, black to white
Display refresh rate	59.94 frames per second
Displayed intensity levels	Supports Windows SVGA high-color mode (16-bit)

Table A- 6: Input/output port specifications

Characteristic	Description				
✓ Probe Compensator Output	Front-panel BNC connector, requires Probe Cal Deskew Fixture for probe attachment				
	<table border="1"> <thead> <tr> <th>Output voltage</th> <th>Frequency</th> </tr> </thead> <tbody> <tr> <td>1.0 V (from base to top) \pm 1.0% into a $\geq 50 \Omega$ load</td> <td>1 kHz \pm 5%</td> </tr> </tbody> </table>	Output voltage	Frequency	1.0 V (from base to top) \pm 1.0% into a $\geq 50 \Omega$ load	1 kHz \pm 5%
	Output voltage	Frequency			
1.0 V (from base to top) \pm 1.0% into a $\geq 50 \Omega$ load	1 kHz \pm 5%				
Note: During probe calibration only, a relay switches a DC calibration voltage to this output in place of the 1kHz square wave. This voltage varies from -10 V to +10 V with a source impedance less than 1 W and short circuit current as high as 300 mA.					
✓ Analog Signal Output amplitude	Front-panel BNC connector, provides a buffered version of the signal that is attached to the channel 3 input 20 mV/div \pm 20% into a 1 M Ω load 10 mV/div \pm 20% into a 50 Ω load				
Analog Signal Output bandwidth, typical	100 MHz into a 50 Ω load				
✓ Auxiliary Output levels	Front-panel BNC connector, provides a TTL-compatible pulse (polarity selectable) for each A or B trigger (selectable)				
	<table border="1"> <thead> <tr> <th>$V_{out\ high}$</th> <th>$V_{out\ low\ (true)}$</th> </tr> </thead> <tbody> <tr> <td>≥ 2.5 V into open circuit, ≥ 1.0 V into 50 Ω load</td> <td>≤ 0.7 V with ≤ 4 ma sink, ≤ 0.25 V into 50 Ω load</td> </tr> </tbody> </table>	$V_{out\ high}$	$V_{out\ low\ (true)}$	≥ 2.5 V into open circuit, ≥ 1.0 V into 50 Ω load	≤ 0.7 V with ≤ 4 ma sink, ≤ 0.25 V into 50 Ω load
	$V_{out\ high}$	$V_{out\ low\ (true)}$			
≥ 2.5 V into open circuit, ≥ 1.0 V into 50 Ω load	≤ 0.7 V with ≤ 4 ma sink, ≤ 0.25 V into 50 Ω load				
Auxiliary Output pulse width, typical	Pulse width varies, 1 μ s minimum				
External reference	Run SPC whenever the external reference is more than 2000 ppm different than the internal reference or the reference at which SPC was last run.				
Frequency range	9.8 MHz to 10.2 MHz.				
Input sensitivity	≥ 200 mV _{p-p}				
Input voltage, maximum	7 V _{p-p}				
Input impedance	1.5 k Ω , 40 pF. Measure impedance at >100 kHz to make the blocking capacitor invisible				

Table A-6: Input/output port specifications (Cont.)

Characteristic	Description	
Internal reference output		
Frequency	10 MHz \pm \approx 2.5 ppm over any \geq 100 ms interval. Aging < 1 ppm per year	
Output voltage	$V_{out\ high}$	$V_{out\ low\ (true)}$
	\geq 2.5 V into open circuit, \geq 1.0 V into 50 Ω load	\leq 0.7 V with \leq 4 ma sink, \leq 0.25 V into 50 Ω load
Rear-panel I/O ports	Ports located on the rear panel	
Parallel port (IEEE 1284)	DB-25 connector, supports the following modes: -standard (output only) bidirectional (PS-2 compatible) bidirectional enhanced parallel port (IEEE 1284 standard, mode 1 or mode 2, v 1.7) -bidirectional high-speed extended capabilities	
Audio ports	Miniature phone jacks for stereo microphone input and stereo line output	
USB port	Allows connection or disconnection of USB keyboard and/or mouse while oscilloscope power is on	
Keyboard port	PS-2 compatible, oscilloscope power must be off to make connection	
Mouse port	PS-2 compatible, oscilloscope power must be off to make connection	
LAN port	RJ-45 connector, supports 10 base-T and 100 base-T	
Serial port	DB-9 COM1 port, uses NS16C550-compatible UARTS, transfer speeds up to 115.2 kb/s	
SVGA video port	Upper video port, DB-15 female connector, connect a second monitor to use dual-monitor display mode, supports Basic requirements of PC99 specifications	
GPIB port	IEEE 488.2 standard interface	
Scope VGA video port	Lower video port, DB-15 female connector, 31.6 kHz sync, EIA RS-343A compliant, connect to show the oscilloscope display, including live waveforms, on an external monitor	

Table A-7: Data storage specifications

Characteristic	Description
CD-ROM	Rear-panel CD-ROM drive
Floppy disk	Front-panel 3.5 in floppy disk drive, 1.44 MB capacity
Hard disk	Rear-panel, removeable hard disk drive, ≥ 20 GB capacity
Nonvolatile memory, typical	Approximately 100 kB are available for waveform storage in nonvolatile memory (for example, up to two 50,000 point waveforms can be stored)
Nonvolatile memory retention time, typical	≥ 5 years
Windows memory	512 MB

Table A-8: Power source specifications

Characteristic	Description
Source voltage and frequency	100 to 240 V $\pm 10\%$, 50 Hz to 60 Hz 115 V $\pm 10\%$, 400 Hz
Power consumption	≤ 600 Watts (900 VA)
Overvoltage Category	Overvoltage Category II (as defined in IEC 1010-1, Annex J)
Fuse rating	Either one of the following sizes can be used, each size requires a different fuse cap. Both fuses must be the same type
0.25 in \times 1.25 in size	UL198G and CSA C22.2, No. 59, fast acting: 8 A, 250 V (Tektronix part number 159-0046-00, Bussman ABC-8, Littelfuse 314008)
5 mm \times 20 mm size	IEC127, sheet 1, fast acting "F", high breaking capacity: 6.3 A, 250 V (Bussman GDA 6.3, Littelfuse 21606.3)

Table A-9: Mechanical specifications

Characteristic	Description	
Weight		
Benchtop configuration	39 lbs (18 kg) oscilloscope only 42 lbs (19 kg) with fully accessorized pouch 86 lbs (39 kg) when packaged for domestic shipment	
Rackmount kit	5 lbs (2.3 kg) rackmount conversion kit 8 lbs (3.6 kg) kit packaged for domestic shipment	
Dimensions		
Benchtop configuration	10.9 in (277 mm) height, 13 in (330 mm) with feet extended 17.9 in (455 mm) width 16.8 in (425 mm) depth	
Rackmount configuration (Option 1R)	10.5 in (267 mm) height 19 in (483 mm) width 22 in (559 mm) depth	
Cooling	Fan-forced air circulation with no air filter.	
Required clearances	Top	0 in (0 mm)
	Bottom	0.75 in minimum or 0 in (0 mm) when standing on the feet
	Left side	3 in (76 mm)
	Right side	3 in (76 mm)
	Front	0 in (0 mm)
	Rear	0 in (0 mm)
Construction material	Chassis parts are constructed of aluminum alloy, front panel is constructed of plastic laminate, circuit boards are constructed of glass laminate, outer shell is molded and textured from a polycarbonate/ABS blend	

Table A- 10: Environmental specifications

Characteristic	Description
Temperature, operating	0 °C to +50 °C, excluding floppy disk and CD-ROM drives +10 °C to +45 °C, including floppy disk and CD-ROM drives
Nonoperating	-22 °C to +60 °C
Humidity, operating	20% to 80% relative humidity with a maximum wet bulb temperature of +29 °C at or below +50 °C, noncondensing Upper limit derated to 25% relative humidity at +50 °C
Nonoperating	With no diskette in floppy disk drive 5% to 90% relative humidity with a maximum wet bulb temperature of +29 °C at or below +60 °C, noncondensing Upper limit derated to 20% relative humidity at +60 °C
Altitude, operating	10,000 ft (3,048 m)
Nonoperating	40,000 ft (12, 190 m)
Random vibration, operating	0.24 g _{RMS} from 5 Hz to 500 Hz, 10 minutes on each axis, 3 axis, 30 minutes total, with floppy disk and/or CD-ROM installed
Nonoperating	2.46 g _{RMS} from 5 Hz to 500 Hz, 10 minutes on each axis

Table A-11: Certifications and compliances

Category	Standards or description
EC Declaration of Conformity - EMC	<p>Meets intent of Directive 89/336/EEC for Electromagnetic Compatibility. Compliance was demonstrated to the following specifications as listed in the Official Journal of the European Union:</p> <p>EN 61326 Emissions ^{1, 3} Class A Radiated and Conducted Emissions</p> <p>EN 61326 Immunity ^{1,2,4}</p> <p>IEC 1000-4-2 Electrostatic Discharge Immunity ±4 kV contact discharge, ±8 kV air discharge, performance criterion B</p> <p>IEC 1000-4-3 RF field immunity 3 V/m, 80 MHz to 1 GHz, 80% amplitude modulated with a 1 kHz sinewave performance criterion A</p> <p>IEC 1000-4-4 Electrical Fast Transient/Burst Immunity 1 kV on AC mains, 500 V on I/O cables, performance criterion B</p> <p>IEC 1000-4-5 AC Surge Immunity 1 kV differential mode, 2 kV common mode, performance criterion B</p> <p>IEC 1000-4-6 RF Conducted Immunity 3 V, 150 kHz to 80 MHz, amplitude modulated with a 1 kHz sinewave, performance criterion A</p> <p>IEC 1000-4-11 AC Mains Voltage Dips and Interruption Immunity 100% reduction for one cycle, performance criterion B</p> <p>EN 61000-3-2 Power Harmonic Current Emissions</p> <p>¹ If interconnect cables are used, they must be low-EMI shielded cables such as the following Tektronix part numbers or their equivalents: 012-0991-01, 012-0991-02 or 012-0991-03 GPIB Cable; 012-1213-00 (or CA part number 0294-9) RS-232 Cable; 012-1214-00 Centronics Cable; or LCOM part number CTL3VGAMM-5 VGA Cable.</p> <p>² The performance criteria for when the oscilloscope is subjected to the conditions described above are defined as follows: A — ≤0.2 division waveform displacement or ≤0.4 division increase in peak-to-peak noise B — temporary, self-recoverable degradation or loss of performance is allowed, but no change of actual operating state or loss of stored data is allowed C — temporary loss of function is allowed provided that the function is self recoverable or can be restored by the operation of the controls</p> <p>³ Radiated emissions may exceed the levels specified in EN 61326 when this oscilloscope is connected to a test object.</p> <p>⁴ USB mouse and keyboard only, performance criterion C. Normal USB keyboard or mouse operation can be restored by unplugging and reconnecting the USB connector to the oscilloscope.</p>
FCC	Radiated and conducted emissions do not exceed the levels specified in FCC47 CFR, Part 15, Subpart B, for Class A equipment.

Table A- 11: Certifications and compliances (cont.)

Category	Standards or description
EC Declaration of Conformity - Low Voltage	<p>Compliance was demonstrated to the following specification as listed in the Official Journal of the European Union:</p> <p>Low Voltage Directive 73/23/EEC, amended by 93/68/EEC</p> <p>EN 61010-1/A2:1995 Safety requirements for electrical equipment for measurement control and laboratory use.</p>
U.S. Nationally Recognized Testing Laboratory Listing	<p>UL3111-1, First Edition Standard for electrical measuring and test equipment.</p>
Canadian Certification	<p>CAN/CSA C22.2, No. 1010.1-92 Safety requirements for electrical equipment for measurement, control, and laboratory use.</p>
Additional Compliance	<p>IEC61010-1 Safety requirements for electrical equipment for measurement, control, and laboratory use.</p>
Installation (Overvoltage) Category Definition	<p>Terminals on this product may have different installation (overvoltage) category designations. The installation categories are:</p> <p>CAT III Distribution-level mains (usually permanently connected). Equipment at this level is typically in a fixed industrial location.</p> <p>CAT II Local-level mains (wall sockets). Equipment at this level includes appliances, portable tools, and similar products. Equipment is usually cord-connected.</p> <p>CAT I Secondary (signal level) or battery operated circuits of electronic equipment.</p>
Pollution Degree Definition	<p>A measure of the contaminates that could occur in the environment around and within a product. Typically the internal environment inside a product is considered to be the same as the external. Products should be used only in the environment for which they are rated.</p> <p>Pollution Degree 2 Normally only dry, nonconductive pollution occurs. Occasionally a temporary conductivity that is caused by condensation must be expected. This location is a typical office/home environment. Temporary condensation occurs only when the product is out of service.</p>
Safety Certification Compliance	
Equipment Type	Test and measuring
Safety Class	Class 1 (as defined in IEC 1010-1, Annex H) - grounded product
Pollution Degree	Pollution Degree 2 (as defined in IEC 1010-1). Note: Rated for indoor use only.

Appendix B: Automatic Measurements Supported

This appendix provides a list of all supported measurements and their definition. An illustration showing the levels used to take measurements is also included.

Table B- 1: Supported measurements and their definition













Name	Definition
 Amplitude	Voltage measurement. The high value less the low value measured over the entire waveform or gated region. <i>Amplitude = High-Low</i>
 Area	Area measurement (Voltage over time measurement). The area over the entire waveform or gated region in volt-seconds. Area measured above ground is positive; area below ground is negative.
 Cycle Area	Voltage over time measurement. The area over the first cycle in the waveform, or the first cycle in the gated region, in volt-seconds. Area measured above ground is positive; area below ground is negative.
 Burst Width	Timing measurement. The duration of a burst. Measured over the entire waveform or gated region.
 Cycle Mean	Voltage measurement. The arithmetic mean over the first cycle in the waveform or the first cycle in the gated region.
 Cycle RMS	Voltage measurement. The true Root Mean Square voltage over the first cycle in the waveform or the first cycle in the gated region.
 Delay	Timing measurement. The time between the MidRef crossings of two different traces or the gated region of the traces.
 Fall Time	Timing measurement. Time taken for the falling edge of the first pulse in the waveform or gated region to fall from a High Ref value (default = 90%) to a Low Ref value (default = 10%) of its final value.
 Frequency	Timing measurement for the first cycle in the waveform or gated region. The reciprocal of the period. Measured in Hertz (Hz) where 1 Hz = 1 cycle per second.
 High	The value used as 100% whenever High Ref, Mid Ref, and Low Ref values are needed (as in fall time and rise time measurements). Calculated using either the min/max or the histogram method. The <i>min/max</i> method uses the maximum value found. The <i>histogram</i> method uses the most common value found above the mid point. Measured over the entire waveform or gated region.
 Low	The value used as 0% whenever High Ref, Mid Ref, and Low Ref values are needed (as in fall time and rise time measurements). May be calculated using either the min/max or the histogram method. With the min/max method it is the minimum value found. With the histogram method, it refers to the most common value found below the midpoint. Measured over the entire waveform or gated region.
 Maximum	Voltage measurement. The maximum amplitude. Typically the most positive peak voltage. Measured over the entire waveform or gated region.
 Mean	Voltage measurement. The arithmetic mean over the entire waveform or gated region.

Table B-1: Supported measurements and their definition (Cont.)

















Name	Definition
 Minimum	Voltage measurement. The minimum amplitude. Typically the most negative peak voltage. Measured over the entire waveform or gated region.
 Negative Duty Cycle	Timing measurement of the first cycle in the waveform or gated region. The ratio of the negative pulse width to the signal period expressed as a percentage. $NegativeDutyCycle = \frac{NegativeWidth}{Period} \times 100\%$
 Negative Overshoot	Voltage measurement. Measured over the entire waveform or gated region. $NegativeOvershoot = \frac{Low-Min}{Amplitude} \times 100\%$
 Negative Width	Timing measurement of the first pulse in the waveform or gated region. The distance (time) between MidRef (default 50%) amplitude points of a negative pulse.
 Peak to Peak	Voltage measurement. The absolute difference between the maximum and minimum amplitude in the entire waveform or gated region.
 Phase	Timing measurement. The amount one waveform leads or lags another in time. Expressed in degrees, where 360° comprise one waveform cycle.
 Period	Timing measurement. Time it takes for the first complete signal cycle to happen in the waveform or gated region. The reciprocal of frequency. Measured in seconds.
 Positive Duty Cycle	Timing measurement of the first cycle in the waveform or gated region. The ratio of the positive pulse width to the signal period expressed as a percentage. $PositiveDutyCycle = \frac{PositiveWidth}{Period} \times 100\%$
 Positive Overshoot	Voltage measurement over the entire waveform or gated region. $PositiveOvershoot = \frac{Max-High}{Amplitude} \times 100\%$
 Positive Width	Timing measurement of the first pulse in the waveform or gated region. The distance (time) between MidRef (default 50%) amplitude points of a positive pulse.
 Rise time	Timing measurement. Time taken for the leading edge of the first pulse in the waveform or gated region to rise from a Low Ref value (default = 10%) to a High Ref value (default = 90%) of its final value.
 RMS	Voltage measurement. The true Root Mean Square voltage over the entire waveform or gated region.
 Mean	The average of all acquired points within (or on) the histogram box.
 Median	Half of all acquired points within (or on) the histogram box are less than and half are greater than this value.
 StdDev	The standard deviation (Root Mean Square (RMS) deviation) of all acquired points within (or on) the histogram box.
 Hits in Box	Displays the number of points in the histogram box or on the box boundary.
 Waveform Count	Displays the number of waveforms that have contributed to the histogram.

Table B- 1: Supported measurements and their definition (Cont.)







Name	Definition
 Peak Hits	Displays the number of points in the largest bin of the histogram.
 Pk-Pk	Displays the peak-to-peak value of the histogram. Vertical histograms display the “voltage” of the highest nonzero bin minus the “voltage” of the lowest nonzero bin. Horizontal histograms display the “time” of the rightmost nonzero bin minus the “time” of the leftmost nonzero bin (Max - Min).
 Max	Displays the maximum voltage or time.
 Min	Displays the minimum voltage or time.
 Mean ± 1 StdDev	The percentage of points in the histogram which are within 1 standard deviation of the histogram mean.
 Mean ± 2 StdDev	The percentage of points in the histogram which are within 2 standard deviations of the histogram mean.
 Mean ± 3 StdDev	The percentage of points in the histogram which are within 3 standard deviations of the histogram mean.

Table B- 2: Supported mask measurements and their definition (Option SM only)













Name	Definition
 Ext Ratio	The ratio of eye top to base. $Ext\ Ratio = PTop_{mean}/PBase_{mean}$
 Extinction Ratio %	The ratio of eye base to top in %. $Ext\ Ratio\ \% = 100*(PBase_{mean}/PTop_{mean})$
 Extinction Ratio dB	The ratio of eye top to base in dB. $Ext\ Ratio\ dB = 10*Log(PTop_{mean}/PBase_{mean})$
 Eye Height	The eye height in watts or volts. $Eye\ Height = (PTop_{mean} - 3*PTop_{sigma}) - (PBase_{mean} + 3*PBase_{sigma})$
 Eye Width	The eye width in seconds. $Eye\ Width = (TCross2_{mean} - 3*TCross2_{sigma}) - (TCross1_{mean} + 3*TCross1_{sigma})$
 Crossing %	The eye crossing point as a percentage of eye height. $Crossing\ \% = 100*[(PCross1_{mean} - PBase_{mean})/(PTop_{mean} - PBase_{mean})]$
Eye Top	The top of the eye.
Eye Base	The base of the eye.
 Jitter Pk- Pk	The peak-to-peak value for the edge jitter in the current horizontal units. $Jitter\ PP = TCross1_{pp}$

Table B-2: Supported mask measurements and their definition (Option SM only) (Cont.)

Name	Definition
 Jitter RMS	The RMS value of the edge jitter in the current horizontal units. $Jitter\ RMS = TCross1_{sigma}$
Jitter 6σ	$6 \times (Jitter\ RMS)$
 Noise Pk-Pk	The peak-to-peak value of the noise of the top or base of the signal as specified by the user. $Noise\ Pk-Pk = PTop_{pk-pk}\ or\ PBase_{pk-pk}$
 Noise RMS	The RMS value of the noise of the top or base of the signal as specified by the user. $Noise\ RMS = PTop_{sigma}\ or\ PBase_{sigma}$
 S/N Ratio	Ratio of the signal amplitude to the noise of the top or base of the signal as specified by the user. $S/N\ Ratio = (PTop - PBase)/(PTop_{sigma}\ or\ PBase_{sigma})$
 Duty Cycle Distortion	The peak-to-peak time variation of the first eye crossing measured at the MidRef as a percent of the eye period. $DCD\ (sec) = 100\% \times TDCD_{p-p}/(TCross2_{mean} - TCross2_{mean})$
 Quality Factor	Ratio of eye size to noise. $Quality\ Factor = (PTop_{mean} - PBase_{mean})/(PTop_{sigma} + PBase_{sigma})$

Levels Used in Taking Amplitude, Timing, and Area Measurements

Refer to Figure B-1 and the descriptions that follow to interpret the definitions of waveforms in categories Amplitude, Timing, and Area. Low reference, mid reference, and high reference are the default reference levels and are adjustable.

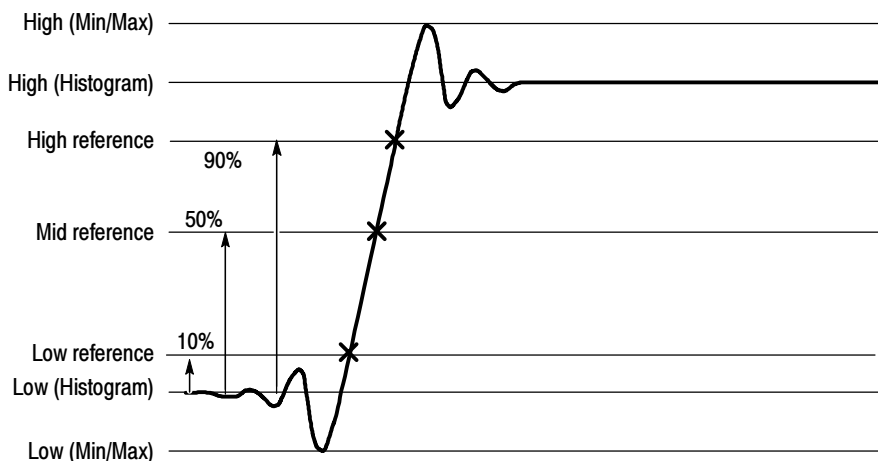

Figure B-1: Levels used to determine measurements

High. The value used as the 100% level in amplitude measurements, such as Peak and +Overshoot. High is also used to help derive the HighRef, MidRef, MidRef2, and LowRef values.

Low. The value used as the 0% level in amplitude measurements, such as Peak and -Overshoot. Low is also used to help derive the HighRef, MidRef, MidRef2, and LowRef values.

HighRef. The waveform high reference level, used in such measurements as fall time and rise time. Typically set to 90%. You can choose how this level is set; see *Reference Levels Method* on page 3-125.

MidRef. The waveform middle reference level used in such measurements as Period and Duty Cycle. Typically set to 50%. You can choose how this level is set; see *Reference Levels Method* on page 3-125.

LowRef. The waveform low reference level. Used in fall and rise time calculations. Typically set to 10%. You can choose how this level is set; see *Reference Levels Method* on page 3-125.

Mid2Ref. The middle reference level for a second waveform (or the second middle reference of the same waveform). Used in two-waveform time measurements, such as the Delay and Phase measurements. You can choose how this level is set; see *Reference Levels Method* on page 3-125.

Levels Used in Taking Eye Measurements (Option SM Only)

All eye-diagram measurements are based on the power level, the voltage level, or the time locations of edges within each acquisition.

Figure B-2 shows an eye-diagram and the areas from which values are taken that are used to calculate measurements.

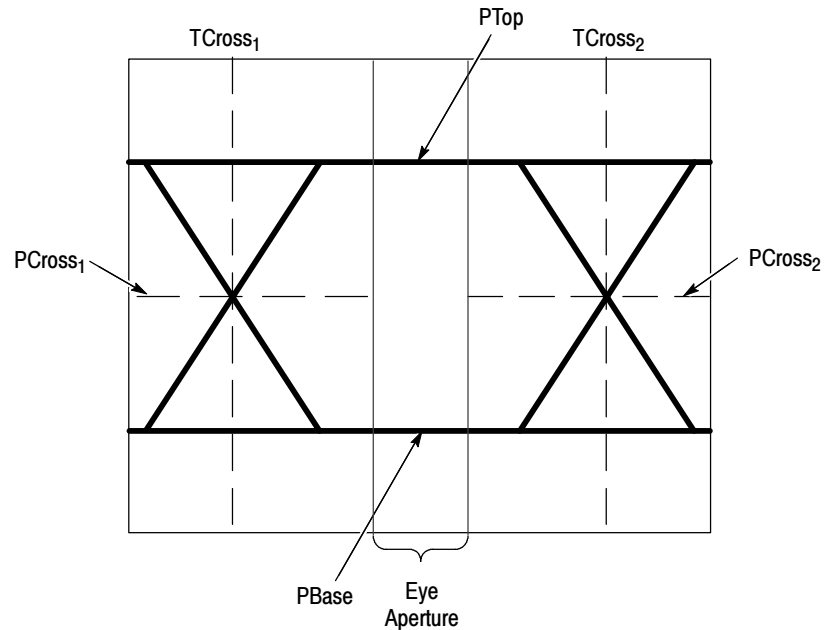

Figure B-2: Eye-diagram and optical values

P Values

The P values include the mean and standard deviation of the vertical location of P_{Top} and P_{Base} . These areas are used with a specified sample size to statistically measure the following values:

- $P_{Top_{mean}}$, the mean value of P_{Top}
- $P_{Top_{sigma}}$, the standard deviation of P_{Top}
- $P_{Base_{mean}}$, the mean value of P_{Base} within the Eye Aperture¹
- $P_{Base_{sigma}}$, the standard deviation of P_{Base} within the Eye Aperture¹

¹The Eye Aperture defaults to the center 20% of the interval from $TCross_1$ to $TCross_2$.

T1 Values

The T1 values are vertical and horizontal values associated with the leftmost crossing point. These areas are used to establish the following directions:

- $TCross1_{mean}$, the horizontal mean of the left crossing point at $TCross_1$
- $TCross1_{sigma}$, the horizontal standard deviation of the left crossing point at $TCross_1$
- $TCross1_{p-p}$, the horizontal peak-to-peak deviation of the left crossing point at $TCross_1$
- $PCross1_{mean}$, the vertical mean of the left crossing point at $PCross_1$

T2 Values

The T2 values are vertical and horizontal values associated with the rightmost crossing point. These areas are used to establish the following directions:

- $TCross2_{mean}$, the horizontal mean of the right crossing point at $TCross_2$
- $TCross2_{sigma}$, the horizontal standard deviation of the right crossing point at $TCross_2$
- $TCross2_{p-p}$, the horizontal peak-to-peak deviation of the right crossing point at $TCross_2$

DCD Values

The duty cycle distortion (DCD) values are horizontal values associated with the rightmost crossing point at 50% of the eye height. These areas are used to establish the DCD_{p-p} , the horizontal peak-to-peak deviation of the left crossing point at half the height of the eye.

Appendix C: Cleaning

Use these procedures to clean your oscilloscope. If additional cleaning is required, have your oscilloscope serviced by qualified service personnel.



CAUTION. *To prevent getting moisture inside the oscilloscope during external cleaning, use only enough liquid to dampen the cloth or applicator.*

Exterior Cleaning

Clean the exterior surfaces of the chassis with a dry lint-free cloth or a soft-bristle brush. If any dirt remains, use a cloth or swab dipped in a 75% isopropyl alcohol solution. Use a swab to clean narrow spaces around controls and connectors. Do not use abrasive compounds on any part of the chassis.

Clean the On/Standby switch using a dampened cleaning towel. Do not spray or wet the switch directly.



CAUTION. *Do not use chemical cleaning agents which might damage the plastics used in this oscilloscope. Use only deionized water when cleaning the front-panel buttons. Use a 75% isopropyl alcohol solution as a cleaner and rinse with deionized water. Before using any other type of cleaner, consult your Tektronix Service Center or representative.*

Flat Panel Display Cleaning

The display is soft plastic and must be treated with care during cleaning.



CAUTION. *Improper cleaning agents or methods can damage the flat panel display.*

Do not use abrasive cleaners or commercial glass cleaners to clean the display.

Do not spray liquids directly on the display surface.

Do not scrub the display with excessive force.

Clean the flat panel display surface by gently rubbing the display with a clean-room wipe (such as Wypall Medium Duty Wipes, #05701, available from Kimberly-Clark Corporation).

If the display is very dirty, moisten the wipe with distilled water or a 75% isopropyl alcohol solution and gently rub the display surface. Avoid using excess force or you may damage the plastic display surface.

Appendix D: Menu Bar Commands

Both the oscilloscope menu bar and a tool bar allow you to control oscilloscope operation. Where possible, this manual describes operation using first, the front panel and then, the tool bar. This appendix describes functions available from the menu bar. For more information about these commands, see the online help.

File Commands

Table D-1 lists the commands available from the File menu on the menu bar.

Table D- 1: File menu commands

Menu	Submenu	Function
Reference Waveforms	Reference Setup	Displays the Reference Setup window that you use to set up and control reference waveforms
	Display On/Off	Displays the Waveform Display control window that you can use to turn the display of waveforms on and off
	Position/Scale	Displays the control window that you use to position the waveform, and set the vertical scale
	Label	Displays a control window that you use to label your waveforms
	Save Wfm	Displays the Reference Setup window that you use to save and control reference waveforms
	Save All Wfm	Displays the window that you use to save all reference waveforms
	Recall Wfm	Displays the Reference Setup window that you use to recall and control reference waveforms
	Delete All Refs	Deletes all reference waveforms
Instrument Setup		Displays the Instrument Setup window that you use to save instrument setups to nonvolatile memory or to a file, recall saved setups, or delete saved setups
Recall Default Setup		Recalls the factory default oscilloscope setup
Run Application	(depends on installed applications)	Allows you to start an optional application
Page Setup		Displays the Page Setup dialog box that you use to define the page before sending data to a printer
Print Preview		Shows you a preview of the page before you print the page
Print		Displays the Print dialog box that you use to send data to your printer

Table D-1: File menu commands (Cont.)

Menu	Submenu	Function
Export Setup		Displays the Export Setup window you use to set up and export images, waveforms, and measurements: Images: Select the Palette (Color, GrayScale, or Black & White), View (Full Screen or Graticules Only), Image (Normal or InkSaver Mode), or Data Format used when exporting images Waveforms: Select the Data Destination, channel Source, data range, Waveform Detail, and Data Ordering used when exporting waveforms Measurements: Select the Data Format and type of Measurements used when exporting measurements
Select for Export	Full Screen (bitmap), Graticule (bitmap), Waveform (data), Measurements (data)	Select from the list what you want to export to a file or use with other applications
Export		Exports the full screen, graticule, waveform, or measurement to a file other application
1 Recent Setup File 1		Recalls (loads) the most recent setup file
Minimize		Minimizes the oscilloscope application, displaying the Windows desktop
Shutdown		Shut downs the oscilloscope

Edit Commands

Table D-2 lists the commands available from the Edit menu on the menu bar.

Table D-2: Edit menu commands

Menu	Submenu	Function
Undo Last Autoset		Undoes the last autoset
Copy		Copies the full screen, graticule, waveform, or measurement to the clipboard for use with other applications
Select for Copy	Full Screen (bitmap), Graticule (bitmap), Waveform (data), Measurement (data)	Select from the list what you want to copy to the clipboard
Copy Setup		Displays the Copy Setup window that you use to set up and copy images, waveforms, and measurements: Images: Select the Palette (Color, GrayScale, or Black & White), View (Full Screen or Graticules Only), Image (Normal or InkSaver Mode), or Data Format used when copying images Waveforms: Select the Data Destination, channel Source, data range, Waveform Detail, and Data Ordering used when copying waveforms Measurements: Select the Data Format and type of Measurements used when copying measurements

Vertical Commands

Table D-3 lists the commands available from the Vertical menu.

Table D-3: Vertical menu commands

Menu	Submenu	Function
Vertical Setup		Displays the Vertical Setup window that you use to set the position, scale, offset, termination, coupling, bandwidth of a channel. You can also calibrate, deskew, and set the external attenuation of attached probes
Zoom Controls		Displays the Zoom control window that you use to set the position and scale of zoomed waveforms
Display On/Off		Displays the Waveform Display control window that you can use to turn the display of waveforms on and off
Position/Scale		Displays the control window that you use to position the waveform, and set the vertical scale
Label		Displays a control window that you use to label your waveforms

Table D-3: Vertical menu commands (Cont.)

Menu	Submenu	Function
Offset		Displays the Vertical Offset control window you use to set the vertical offset and scale of a waveform
Termination		Displays the Termination control window you use to select input termination for a channel
Coupling		Displays the Coupling control window you use to select input coupling for a channel
Bandwidth		Displays the Bandwidth control window you use to set the bandwidth of a channel
Probe Cal		Displays the Probe Cal control window you use to check a probe status and compensate the entire signal path from the probe tip to digitized signal
Deskew		Displays the Deskew control window you use to compensate for propagation delays of input channels
Attenuation		Displays the Attenuation control window you use to set the external attenuation or gain between the signal and the input channels
Zoom Setup		Displays the Zoom Setup window you use to set up the horizontal and vertical zoom controls
Zoom Graticule	50/50%	Sets the zoom graticule split mode to 50/50%
	80%/20%	Sets the zoom graticule split mode to 80/20%
	100%	Sets the zoom graticule split mode to 100%

Horizontal and Acquisition Commands

Table D-4 lists the commands available from the Horiz/Acq menu.

Table D-4: Horiz/Acq menu commands

Menu	Submenu	Function
Horizontal/Acquisition Setup		Displays the Horizontal and Acquisition Setup window you use to set up the Horizontal and Vertical subsystems: <i>Horizontal:</i> You can set the record length, scale, resolution, sample rate, duration delay, reference point, and zoom <i>Acquisition:</i> You can set the acquisition mode, enable fast acquisitions, roll mode, equivalent time, and FastFrame
Zoom Controls		Displays the Zoom control window you use to set the position and scale of zoomed waveforms
Autoset		Automatically sets up the front-panel controls based on the characteristics of the input signal and default selections

Table D- 4: Horiz/Acq menu commands (Cont.)

Menu	Submenu	Function
Undo Last Autoset		Undoes the last autoset
Fast Acquisitions		Toggles Fast Acquisitions mode on and off
Run/Stop		Displays the Run/Stop control window that you can use to start and stop acquisitions, control a single sequence of acquisitions, and display the acquisition status
Delay Mode On		Toggles horizontal delay mode on and off
Roll Mode Auto		Toggles roll mode on and off. When on, the oscilloscope automatically enters roll mode at slower horizontal scale settings
Equivalent Time Auto		Toggles equivalent time on and off. When on, the oscilloscope automatically uses equivalent time sampling when the sample rate is too fast to acquire enough samples using real-time sampling
Position/Scale		Displays the Horizontal control window that you use to turn on and off delay mode, position the waveform, and set the horizontal scale
Resolution		Displays the Resolution control window that you use to set the record length and view the duration, sample rate, and resolution
Acquisition Mode		Displays the Acquisition Mode control window that you use to select the acquisition mode
FastFrame Setup		Displays the FastFrame Setup window that you use to set up FastFrame acquisitions
FastFrame Controls		Displays the FastFrame control window that you use to select the frame to view and the reference frame used by time stamps
Zoom Setup		Displays the Zoom Setup window that you use to set up the horizontal and vertical zoom controls
Zoom Graticule	50/50% 80%/20% 100%	Sets the zoom graticule split mode to 50/50% Sets the zoom graticule split mode to 80/20% Sets the zoom graticule split mode to 100%
Zoom Lock	All Live None	Sets Zoom Lock so that all waveforms are adjusted Sets Zoom Lock so that all channels and live math waveforms are adjusted Sets Zoom Lock so that the selected waveform is adjusted
Zoom Display Area		Displays the Zoom Display Area control window that you use to set the zoom graticule split mode

Trigger Commands

Table D-5 lists the commands available from the Trig menu on the menu bar.

Table D-5: Trig menu commands

Menu	Submenu	Function
A Event (Main) Trigger Setup		Displays the Trigger Setup window you use to set up the A Event triggers
Quick Select	Edge, Glitch, Width, Runt, Timeout, Transition, Setup/Hold, Logic Pattern, Logic State, Comm (optional)	Sets up the selected trigger type
Edge Setup		Displays the Trigger Setup window and sets up the selected trigger type
Glitch Setup		
Width Setup		
Runt Setup		
Timeout Setup		
Transition Setup		
Setup/Hold Setup		
Logic Pattern Setup		
Logic State Setup		
Comm Setup		Displays the Trigger Setup window and sets up the selected trigger type (Option SM only)
A-B Trigger Sequence		Displays the Trigger Setup window and sets up the selected trigger type
B Event (Delayed) Trigger Setup		
Holdoff		Displays the trigger Holdoff control window you use to set trigger holdoff
Mode		Displays the Trigger Mode control window you can use to select the trigger mode, force a trigger, and set the trigger level to 50%
Run/Stop		Displays the Run/Stop control window you can use to start and stop acquisitions, control a single sequence of acquisitions, and display the acquisition status

Display Commands

Table D-6 lists the commands available from the Display menu.

Table D-6: Display menu commands

Menu	Submenu	Function
Display Setup		Display the Display Setup window (select the display appearance, display screen text, display screen objects, and select colors)
Appearance		Display the Appearance tab of the Display Setup window (select the display style, persistence, intensity, format, and interpolation)
Screen Text		Display the Screen Text tab of the Display Setup window. You can enter text that you can display and position on screen. Changing the waveform position does not move screen text (also see vertical label on page D-3)
Objects		Display the Objects tab of the Display Setup window (select the graticule style, trigger level marker, LCD backlight timeout, and date and time display)
Colors		Display the Colors tab of the Display Setup window (select the color of screen objects)
Display Style	Dots, Vectors, Intensified Samples	Choose Dots to display each waveform as a series of dots Choose Vectors to display vectors or lines between the dots Choose Intensified Samples to display actual samples as bright dots; interpolated dots are blacked out
Display Persistence	Reset All No Persistence, Infinite Persistence, Variable Persistence Persistence Controls	Resets the display persistence Choose from No Persistence, Infinite Persistence, and Variable Persistence Modes Displays the Persistence Controls window that you use to control display persistence
Display Format	YT, XY, XYZ	Choose YT, XY, or XYZ display formats. For additional information see <i>To Set Display Format</i> on page 3-45
Waveform Interpolation	Sin(x)/x, Linear	Choose from Sin(x)/x or Linear interpolation
Graticule Style	Full, Grid, Cross-Hair, Frame	Choose from: Full, Grid, Cross-hair, and Frame styles
Record View Palette	Normal, Monochrome Gray, Monochrome Green, Temperature Grading, Spectral Grading, User	Choose Normal to use system colors for best viewing Choose Green to display waveforms in shades of green Choose Gray to display waveforms in shades of gray Choose Temp (temperature) to display waveforms with the highest sample density points appearing in warmer colors (reds) Choose Spectral to display waveforms with the highest sample density points appearing in blue shades Choose User to display a control window to design your own colors

Table D-6: Display menu commands (Cont.)

Menu	Submenu	Function
FastAcq/WfmDB Palette	Normal, Monochrome Green, Monochrome Gray, Temperature Grading, Spectral Grading, User	Choose Normal to use system colors for best viewing Choose Green to display fast acquisition and waveform database waveforms in shades of green Choose Gray to display fast acquisition and waveform database waveforms in shades of gray Choose Temp (temperature) to display fast acquisition and waveform database waveforms with the highest sample density points appearing in warmer colors (reds) Choose Spectral to display fast acquisition and waveform database waveforms with the highest sample density points appearing in blue shades Choose User to display a control window to design your own colors
User Palette		Displays a window that you use to set hue, lightness, and saturation for the selected object. The Reset button allows you to reset the palette to factory defaults. The Setup button displays the Color Setup window.
Display Trigger T		Toggle on and off the display of a T at the trigger point
LCD Backlight Enabled		Toggle the backlight timeout on. When on the back light and LCD (liquid crystal display) turn off and the Windows screen saver will not display. When off the Windows screen saver will display if it is enabled.
Display Date and Time		Toggle on and off the display of the system date and time

Cursors Commands

Table D-7 lists the commands available from the Cursors menu.

Table D-7: Cursor menu commands

Menu	Submenu	Function
Cursor Controls		Displays the Cursor Controls window that you use to set up and control cursors
Cursors On		Toggles cursors on and off
Cursor Type	H-bars, V-bars, Paired, Split	Enables the selected cursor type
Cursor Mode	Independent, Track	Sets the selected cursor tracking mode
Cursor Position		Displays the Cursor Position control window that you use the position of the cursors
Cursor Setup		Displays the Cursor Setup control window that you use to set up and control cursors

Measure Commands

Table D-8 lists the commands available from the Measure menu.

Table D-8: Measure menu commands

Menu	Submenu	Function
Measurement Setup		Displays the Math Setup control window you use to display measurements, setup measurement reference levels, gating, statistics, and histograms
Snapshot		Displays a snapshot of all single waveform measurements of the selected waveform
Amplitude	High Level, Low Level, Amplitude, Maximum, Minimum, Peak to Peak, Pos Overshoot, Neg Overshoot, Mean, RMS, Cycle Mean, Cycle RMS	Displays the selected measurement of the selected waveform
Time	Rise Time, Fall Time, Positive Width, Negative Width, Period, Frequency, Delay, Pos Duty Cycle, Neg Duty Cycle	Displays the selected measurement of the selected waveform
Comm (Option SM Only)	Ext Ratio, Ext Ratio %, Ext Ratio (dB), Eye Height, Eye Width, Eye Top, Eye Base, Crossing %, Jitter Pk-Pk, Jitter Rms, Jitter 6 Sigma, Noise Pk-Pk, Noise RMS, S/N Ratio, Cycle Distortion, Quality factor	Displays the selected measurement of the selected waveform
More	Area, Cycle Area, Phase, Burst Width	Displays the selected measurement of the selected waveform
Statistics	Reset Statistics	Resets measurement statistics
	Off, Mean, All	Displays the selected measurement statistics of current measurements
	Statistics Controls	Displays the Statistics Controls window
Reference Levels		Displays the Reference Levels setup window you use to set the reference levels used by your measurements
Gating		Displays the Measurement Gating control window you use to define the portion of the waveform you want your measurements taken between

Table D-8: Measure menu commands (Cont.)

Menu	Submenu	Function
Waveform Histograms		Displays the Waveform Histogram setup window you use to set histograms on your waveforms
Reset Histograms		Resets histogram counting
Histogram Measurements	Value Count, Hits in Box, Peak Hits, Median, Maximum, Minimum, Peak to Peak, Mean, Standard Deviation, Mean \pm 1 StdDev, Mean \pm 2 StdDev, Mean \pm 3 StdDev	Displays the selected measurement of the histogram

Masks Commands (Option SM Only)

Table D-9 lists the commands available from the Masks menu on the menu bar.

Table D-9: Masks menu commands

Menu	Submenu	Function
Mask Setup		Displays the Mask Setup window that you use to create mask waveforms
Mask Type		Displays the Type tab of the Mask Setup window that you use to select the type of mask
Source		Displays the Source tab of the Mask Setup window that you use to select the source of mask
Tolerance Setup		Displays the Tolerance Setup tab of the Mask Setup window that you use to set up the mask margin tolerance
Pass/Fail Setup		Displays the Pass/Fail Setup tab of the Mask Setup window that you use to set up pass/fail testing
Pass/Fail Results		Displays the Pass/Fail Results tab of the Mask Setup window that you use to view test results
Mask On		Toggles the mask on or off
Mask Controls		Displays the Mask control window that you use to control mask pass/fail testing and display test results
Mask Configure	Display, AutoSet, Autofit . . .	Displays the Mask Configuration setup window that you use to configure the display, autoset and autofit features of mask testing
Mask Edit Setup		Displays the Mask Edit Setup window that you use to create user masks
Mask Edit Controls		Displays the Mask Edit control window that you use to edit user masks

Math Commands

Table D-10 lists the commands available from the Math menu on the menu bar.

Table D- 10: Math menu commands

Menu	Submenu	Function
Math Setup		Displays the Math Setup control window that you use to create math waveforms
Display On/Off		Toggles the display of math waveforms on and off
Position/Scale		Displays the vertical Position and Scale control window that you can use to change the vertical position and scale of waveforms
Label		Displays a control window that you use to label your waveforms
Ch1-Ch2		Creates a predefined math waveform
Ch3-Ch4		Creates a predefined math waveform
Ch1*Ch2		Creates a predefined math waveform
Ch3*Ch4		Creates a predefined math waveform
Spectral Setup		Displays the Spectral Math Setup control window that you use to create spectral math waveforms
Magnitude Spectrum		Creates a predefined magnitude spectral math waveform
Phase Spectrum		Creates a predefined phase spectral math waveform
Spectral Controls		Displays the Spectral Math controls window that you can use to control your spectral math waveform
Set Math Averages		Displays the Math Averaging controls window that you use to set up averaging in math waveforms
Equation Editor		Displays the Math Equation Editor setup window that you use to create math waveforms

Utilities Commands

Table D-11 lists the commands available from the Utilities menu.

Table D- 11: Utilities menu commands

Menu	Submenu	Function
Tek Secure Erase		Erase all setup and reference memory
Set Time & Date		Displays a menu that you use to set the oscilloscope date and time
GPIO Configuration		Displays a control window that you use to set the GPIO talk/listen mode and the bus address
LAN Server Status		Displays the server status window that allows you to turn the server on and off

Table D-11: Utilities menu commands (Cont.)

Menu	Submenu	Function
External Signals		Choose the source and polarity of the AUX OUT signal Choose the internal or an external clock reference. Whenever you change the reference, you must perform a signal path compensation, see page 3-142
Instrument Calibration		Displays a window that you use to perform signal path compensation and, if in service mode, instrument calibration
Instrument Diagnostics		Displays a window that you use to run oscilloscope diagnostics and view the diagnostic status and error log. If errors are displayed, refer the instrument to qualified service personnel ²
Deassign Multipurpose Knobs		Deassigns the multipurpose knobs from their current function
User Preferences		Displays a window that you use to enable prompts before the oscilloscope performs requested actions, set keypad trigger level defaults, and select whether horizontal scale or sample rate is held constant when you change record length
Option Installation		Displays a window that you use to enable optional features and external applications

² If error code 351 is displayed, from the Utilities/Instrument Calibration menu run Signal Path Compensation and then from the Utilities/Instrument Diagnostics menu run the diagnostics.

Help Commands

Table D-12 lists the commands available from the Help menu on the menu bar.

Table D-12: Help menu commands

Menu	Submenu	Function
Help on Window		Displays online help on the current window
Contents and Index		Displays the contents and index dialog of the online help
Restore Help		If the help window is minimized, help is redisplayed
Specifications		Displays the oscilloscope specifications
Technical Support		Displays how to obtain technical support
Customer Feedback		Displays how to supply customer feedback
About TDS7000		Displays the oscilloscope version number, serial number, instrument id, copyright, installed option list, and option installation key

Glossary

AC coupling

A type of signal transmission that blocks the DC component of a signal but uses the dynamic (AC) component. Useful for observing an AC signal that is normally riding on a DC signal.

Accuracy

The closeness of the indicated value to the true value.

Acquisition

The process of sampling signals from input channels, digitizing the samples into data points, and assembling the data points into a waveform record. The waveform record is stored in memory. The trigger marks time zero in that process.

Acquisition interval

The time duration of the waveform record divided by the record length. Except in equivalent time, the oscilloscope acquires one data point for every acquisition interval.

Aliasing

A false representation of a signal due to insufficient sampling of high frequencies or fast transitions. A condition that occurs when an oscilloscope digitizes at an effective sampling rate that is too slow to reproduce the input signal. The waveform displayed on the oscilloscope may have a lower frequency than the actual input signal.

Amplitude

The High waveform value less the Low waveform value.

AND

A logic (Boolean) function in which the output is true when and only when all the inputs are true. On the oscilloscope, that is a trigger logic pattern and state function.

Area

Measurement of the waveform area taken over the entire waveform or the gated region. Expressed in mixed amplitude and time units, such as volt-seconds. Area above ground is positive; area below ground is negative.

Attenuation

The degree the amplitude of a signal is reduced when it passes through an attenuating device such as a probe or attenuator. That is, the ratio of the input measure to the output measure. For example, a 10X probe will attenuate, or reduce, the input voltage of a signal by a factor of 10.

Automatic trigger mode

A trigger mode that causes the oscilloscope to automatically acquire if triggerable events are not detected within a specified time period.

Autoset

A function of the oscilloscope that automatically produces a stable waveform of usable size. Autoset sets up front-panel controls based on the characteristics of the active waveform. A successful autoset will set the volts/div, time/div, and trigger level to produce a coherent and stable waveform display.

Average acquisition mode

In this mode, the oscilloscope acquires and displays a waveform that is the averaged result of several acquisitions. Averaging reduces the apparent noise. The oscilloscope acquires data as in the sample mode and then averages it according to a specified number of averages.

Averaging

Displaying a trace that is the combined result of several acquisitions, thereby reducing apparent noise.

Bandwidth

The highest frequency signal the oscilloscope can acquire with no more than 3 dB ($\times .707$) attenuation of the original (reference) signal.

Burst width

A timing measurement of the duration of a burst.

Control knob

see Knob

Channel

One type of input used for signal acquisition. The oscilloscope has four channels.

Channel/probe deskew

A relative time delay for each channel. This lets you align signals to compensate for the fact that signals may come in from cables of differing length.

Channel Reference Indicator

The indicator on the left side of the display that points to the position around which the waveform contracts or expands when vertical scale is changed. This position is ground when offset is set to 0 V; otherwise, it is ground plus offset.

Control window

A group of related controls for a major oscilloscope function that the oscilloscope displays at the right of the screen.

Coupling

The association of two or more circuits or systems in such a way that power or information can be transferred from one to the other. You can couple the input signal to the trigger and vertical systems several different ways.

Cursors

Paired markers that you can use to make measurements between two waveform locations. The oscilloscope displays the values (expressed in volts or time) of the position of the active cursor and the distance between the two cursors.

Cycle area

A measurement of waveform area taken over one cycle. Expressed in volt-seconds. Area above ground is positive; area below ground is negative.

Cycle mean

An amplitude (voltage) measurement of the arithmetic mean over one cycle.

Cycle RMS

The true Root Mean Square voltage over one cycle.

DC coupling

A mode that passes both AC and DC signal components to the circuit. Available for both the trigger system and the vertical system.

Delay measurement

A measurement of the time between the middle reference crossings of two different waveforms.

Delay time

The time between the trigger event and the acquisition of post trigger data.

Digitizing

The process of converting a continuous analog signal such as a waveform to a set of discrete numbers representing the amplitude of the signal at specific points in time. Digitizing is composed of two steps: sampling and quantizing.

Display system

The part of the oscilloscope that shows waveforms, measurements, control windows, status, and other parameters.

Distal

The most distant point from a reference point. As used in the oscilloscope, the ending measurement point for timing measurements.

Dragging

The act of changing your touch panel selection by moving your finger without removing it from the screen. The selection that is activated is the last one that you were touching before removing your finger.

Dual Graticule

A display with two graticules. Each one is half the height of the single graticule.

Fast Acquisition mode

A mode that increases the waveform capture rate to up to 200,000 waveforms per second. This very fast capture rate greatly increases the probability that runts, glitches, and other short term changes will accumulate in waveform memory. The oscilloscope then displays the waveform at the normal display rate using variable or infinite persistence. This display mode emulates the display of an analog oscilloscope.

Edge Trigger

Triggering occurs when the oscilloscope detects the source passing through a specified voltage level in a specified direction (the trigger slope).

Envelope acquisition mode

A mode in which the oscilloscope acquires and displays a waveform that shows the variation extremes of several acquisitions.

Equivalent-time sampling (ET)

A sampling mode in which the oscilloscope acquires signals over many repetitions of the event. These oscilloscopes use a type of equivalent-time sampling called *random equivalent-time sampling*, which uses an internal clock that runs asynchronously with respect to the input signal and the signal trigger. The oscilloscope takes samples continuously, independent of the trigger position, and displays them based on the time difference between the sample and the trigger. Although the samples are taken sequentially in time, they are random with respect to the trigger.

Fall Time

A measurement of the time it takes for the trailing edge of a pulse to fall from a HighRef value (typically 90%) to a LowRef value (typically 10%) of its amplitude.

Frequency

A timing measurement that is the reciprocal of the period. Measured in Hertz (Hz) where 1 Hz = 1 cycle per second.

Gated Measurements

A feature that lets you limit automated measurements to a specified portion of the waveform. You define the area of interest using the vertical cursors.

Glitch positive trigger

Triggering occurs if the oscilloscope detects positive spike widths less than the specified glitch time.

Glitch negative trigger

Triggering occurs if the oscilloscope detects negative spike widths less than the specified glitch time.

Glitch either trigger

Triggering occurs if the oscilloscope detects either positive or negative spike widths less than the specified glitch time.

GPIB (General Purpose Interface Bus)

An interconnection bus and protocol that allows you to connect multiple instruments in a network under the control of a controller. Also known as IEEE 488 bus. It transfers data with eight parallel data lines, five control lines, and three handshake lines.

Graticule

A grid on the display screen that creates the horizontal and vertical axes. You can use it to visually measure waveform parameters.

Ground (GND) coupling

Coupling option that disconnects the input signal from the vertical system.

Hardcopy

An electronic copy of the display in a format useable by a printer or plotter.

Hi Res acquisition mode

An acquisition mode in which the oscilloscope averages all samples taken during an acquisition interval to create a record point. That average results in a higher-resolution, lower-bandwidth waveform. That mode only works with real-time, non-interpolated sampling.

High

The value used as 100% in automated measurements (whenever high ref, mid ref, and low ref values are needed as in fall time and rise time measurements). May be calculated using either the min/max or the histogram method. With the min/max method (most useful for general waveforms), it is the maximum value found. With the histogram method (most useful for pulses), it refers to the most common value found above the mid point.

Holdoff, trigger

A specified amount of time after a trigger signal that elapses before the trigger circuit will accept another trigger signal. Trigger holdoff helps ensure a stable display.

Horizontal bar cursors

The two horizontal bars that you position to measure the voltage parameters of a waveform. The oscilloscope displays the value of the active (moveable) cursor with respect to ground and the voltage value between the bars.

Horizontal Reference Point

The point about which the trace is expanded or contracted when horizontal size adjustments are made. The horizontal reference point remains anchored as the rest of the trace grows or shrinks around it.

Initialize

Setting the oscilloscope to a completely known, default condition.

Interpolation

The way the oscilloscope calculates values for record points when the oscilloscope cannot acquire all the points for a complete record with a single trigger event. That condition occurs when the oscilloscope is limited to real time sampling and the time base is set to a value that exceeds the effective sample rate of the oscilloscope. The oscilloscope has two interpolation options: *linear* or *sin(x)/x interpolation*.

Linear interpolation calculates record points in a straight-line fit between the actual values acquired. Sin(x)/x computes record points in a curve fit between the actual values acquired. It assumes all the interpolated points fall in their appropriate point in time on that curve.

Intensity

Display brightness.

Interleaving

A method by which these oscilloscopes attain higher digitizing speeds. The oscilloscope applies the digitizing resources of unused channels (that is, channels that are turned off) to sample those that are in use (turned on). Table 3-3 on page 3-38 lists acquisition rates vs. number of channels that are on.

Knob

A rotary control.

Knob Resolution

The amount of change caused by each click of a knob.

Live Waveforms

Waveforms that can update as the acquisition system updates them. Channel waveforms are live waveforms; reference waveforms are not. Math waveforms are live if they contain live waveforms in their expressions: Ch1 + Ref1 defines a live math waveform; Ref1 + Ref2 does not.

Logic state trigger

The oscilloscope checks for defined combinatorial logic conditions on channels 1, 2, and 3 on a transition of channel 4 that meets the set slope and threshold conditions. If the conditions of channels 1, 2, and 3 are met then the oscilloscope triggers.

Logic pattern trigger

The oscilloscope triggers depending on the combinatorial logic condition of channels 1, 2, 3, and 4. Allowable conditions are AND, OR, NAND, and NOR.

Low

The value used as 0% in automated measurements (whenever high ref, mid

ref, and low ref values are needed as in fall time and rise time measurements). May be calculated using either the min/max or the histogram method. With the min/max method (most useful for general waveforms), it is the minimum value found. With the histogram method (most useful for pulses), it refers to the most common value found below the mid point.

Maximum

Amplitude (voltage) measurement of the maximum amplitude. Typically the most positive peak voltage.

Mean

Amplitude (voltage) measurement of the arithmetic mean over the entire waveform.

Measurement

An automated numeric readout that the oscilloscope provides directly from the displayed trace in real time, without operator intervention.

Measurement Parameter

One of several controls that the oscilloscope operator can exercise over the automated measurement process.

Measurement Statistics

The accumulation of a history of individual measurement readouts, showing the mean and standard deviation of a selected number of samples.

Measurement Tracking

The process of automatically adjusting the measurement parameters to reflect changes in the trace.

Mesial

The middle point of a range of points. The middle measurement point between proximal and distal points for timing measurements, and the intermediate height between baseline and topline for amplitude measurements.

Minimum

Amplitude (voltage) measurement of the minimum amplitude. Typically the most negative peak voltage.

Multipurpose knobs

Front-panel knobs you can use to change the value of the assigned parameter.

NAND

A logic (Boolean) function in which the output of the AND function is complemented (true becomes false, and false becomes true). On the oscilloscope, that is a trigger logic pattern and state function.

Negative duty cycle

A timing measurement representing the ratio of the negative pulse width to the signal period, expressed as a percentage.

Negative overshoot measurement

Amplitude (voltage) measurement.

$$\text{NegativeOvershoot} = \frac{\text{Low} - \text{Min}}{\text{Amplitude}} \times 100\%$$

Negative width

A timing measurement of the distance (time) between two amplitude points — falling-edge *MidRef* (default 50%) and rising-edge *MidRef* (default 50%) — on a negative pulse.

Normal trigger mode

A mode on which the oscilloscope does not acquire a waveform record unless a valid trigger event occurs. It waits for a valid trigger event before acquiring waveform data.

NOR

A logic (Boolean) function in which the output of the OR function is complemented (true becomes false, and false becomes true). On the oscilloscope, that is a trigger logic pattern and state function.

OR

A logic (Boolean) function in which the output is true if any of the inputs are true. Otherwise the output is false. On the oscilloscope, that is a trigger logic pattern and state function.

Oscilloscope

An instrument for making a graph of two factors. These are typically voltage versus time.

Peak Detect acquisition mode

A mode in which the oscilloscope saves the minimum and maximum samples over two adjacent acquisition intervals. For many glitch-free signals, that mode is indistinguishable from the sample mode. (Peak detect mode works with real-time, non-interpolation sampling only.)

Peak-to-Peak

Amplitude (voltage) measurement of the absolute difference between the maximum and minimum amplitude.

Period

A timing measurement of the time covered by one complete signal cycle. It is the reciprocal of frequency and is measured in seconds.

Persistence

The amount of time a data point remains displayed. There are three persistence modes available in the oscilloscope Variable, Infinite and Off.

Phase

A timing measurement between two waveforms of the amount one leads or lags the other in time. Phase is expressed in degrees, where 360° comprise one complete cycle of one of the waveforms. Waveforms measured should be of the same frequency or one waveform should be a harmonic of the other.

Pixel

A visible point on the display. The oscilloscope display is 640 pixels wide by 480 pixels high.

Positive duty cycle

A timing measurement of the ratio of the positive pulse width to the signal period, expressed as a percentage.

Positive overshoot

Amplitude (voltage) measurement.

$$\text{PositiveOvershoot} = \frac{\text{Max} - \text{High}}{\text{Amplitude}} \times 100\%$$

Positive width

A timing measurement of the distance (time) between two amplitude points — rising-edge *MidRef* (default 50%) and falling-edge *MidRef* (default 50%) — on a positive pulse.

Posttrigger

The specified portion of the waveform record that contains data acquired after the trigger event.

Pretrigger

The specified portion of the waveform record that contains data acquired before the trigger event.

Principal Power Switch

The master power switch located on the rear panel of the oscilloscope.

Probe

An oscilloscope input device.

Probe compensation

Adjustment that improves low-frequency response of a probe.

Proximal

The point closest to a reference point. As used in the oscilloscope, the beginning measurement point for timing measurements.

Pulse trigger

A trigger mode in which triggering occurs if the oscilloscope finds a pulse, of the specified polarity, with a width between, or optionally outside, the user-specified lower and upper time limits.

Quantizing

The process of converting an analog input that has been sampled, such as a voltage, to a digital value.

Real-time sampling

A sampling mode where the oscilloscope samples fast enough to completely fill a waveform record from a single trigger event. Use real-time sampling to capture single-shot or transient events.

Record length

The specified number of samples in a waveform.

Reference memory

Memory in a oscilloscope used to store waveforms or settings. You can use that waveform data later for processing. The oscilloscope saves the data even when the oscilloscope is turned off or unplugged.

Reference Waveforms

Waveforms that are static, not live (see live waveforms). Reference waveforms are channel or math waveforms that you save to references. Once saved, they do not update.

Rise time

The time it takes for a leading edge of a pulse to rise from a *LowRef* value (typically 10%) to a *HighRef* value (typically 90%) of its amplitude.

RMS

Amplitude (voltage) measurement of the true Root Mean Square voltage.

Runt trigger

A mode in which the oscilloscope triggers on a runt. A runt is a pulse that crosses one threshold but fails to cross a second threshold before recrossing the first. The crossings detected can be positive, negative, or either.

Sample acquisition mode

The oscilloscope creates a record point by saving the first sample during each acquisition interval. That is the default mode of the acquisition.

Sample interval

The time interval between successive samples in a time base. For real-time digitizers, the sample interval is the reciprocal of the sample rate. For equivalent-time digitizers, the time interval between successive samples represents equivalent time, not real time.

Sampling

The process of capturing an analog input, such as a voltage, at a discrete point in time and holding it constant so that it can be quantized. Two general methods of sampling are: *real-time sampling* and *equivalent-time sampling*.

Screen text

Lines displayed on screen that you use to indicate measurement reference levels and points that an automatic measurement is using to derive the measurement value.

Setting

The state of the front panel and system at a given time.

Setup control window

A group of related controls for a major oscilloscope function that the oscilloscope displays across the bottom of the screen.

Setup/Hold trigger

A mode in which the oscilloscope triggers when a data source changes state within the setup or hold time relative to a clock source. Positive setup times precede the clock edge; positive hold times follow the clock edge. The clock edge may be the rising or falling edge.

Selected waveform

The waveform on which all measurements are performed, and which is affected by vertical position and scale adjustments. The light over one of the channel selector buttons indicates the current selected waveform.

Slew Rate trigger

A mode in which the oscilloscope triggers based on how fast a pulse edge traverses (slews) between an upper and lower threshold. The edge of the pulse may be positive, negative, or either. The oscilloscope can trigger on slew rates faster or slower than a user-specified rate.

Slope

The direction at a point on a waveform. You can calculate the direction by computing the sign of the ratio of change in the vertical quantity (Y) to the change in the horizontal quantity. The two values are rising and falling.

Statistical Measurement

An automated measurement that is derived from color graded waveform data and is based on histograms computed at the crossing levels. A statistical measurement can be selected only in color graded display mode.

Tek Secure

This feature erases all waveform and setup memory locations (setup memories are replaced with the factory setup). Then it checks each location to verify erasure. This feature finds use where this *oscilloscope* is used to gather security sensitive data, such as is done for research or development projects.

Time base

The set of parameters that let you define the time and horizontal axis attributes of a waveform record. The time base determines when and how long to acquire record points.

Timeout trigger

A trigger mode in which triggering occurs if the oscilloscope does NOT find a pulse, of the specified polarity and level, within the specified time period.

Trace

The visible representation of an input signal or combination of signals. Identical to waveform.

Trace Expression

The definition of what the trace displays. It can include one or more channels combined arithmetically and modified by functions.

Trigger

An event that marks time zero in the waveform record. It results in acquisition and display of the waveform.

Trigger level

The vertical level the trigger signal must cross to generate a trigger (on edge trigger mode).

Vertical bar cursors

The two vertical bars you position to measure the time parameter of a waveform record. The oscilloscope displays the value of the active (moveable) cursor with respect to the trigger and the time value between the bars.

Waveform

The shape or form (visible representation) of a signal.

Waveform database mode

An acquisition mode that processes and displays a larger sample of data. The waveform database is a three-dimensional accumulation of source waveform data over several acquisitions. In addition to amplitude and timing information, the database includes a count of the number of times a specific waveform point has been acquired.

Waveform interval

The time interval between record points as displayed.

WfmDB

See *Waveform database*.

XY format

A display format that compares the voltage level of two waveform records point by point. It is useful for studying phase relationships between two waveforms.

XYZ format

A display format that compares the voltage level of two waveform records point by point as in XY format. The displayed waveform intensity is modulated by the CH 3 (Z) waveform record.

YT format

The conventional oscilloscope display format. It shows the voltage of a waveform record (on the vertical axis) as it varies over time (on the horizontal axis).

Index

Symbols

- <, A Trigger control window, 3-74
- >, A Trigger control window, 3-74

Numbers

- 1 Recent Setup File 1, D-2
- 100%, Zoom, D-4
- 50/50%, Zoom, D-4
- 80/20%, Zoom, D-4

A

- A Event (Main) Trigger Setup, D-6
- A Only**, trigger, How to setup, 3-96
- A Only**, A Trigger control window, 3-96
- A Then B**, A->B Seq Trigger control window, 3-96, 3-97
- A Trigger
 - Holdoff**, 3-64
 - Level presets, 3-65, 3-66
 - Trigger When**, 3-86
- A Trigger control window, 3-73, 3-75, 3-79, 3-82, 3-84, 3-87, 3-88, 3-96
 - <, 3-74
 - >, 3-74
 - A Only**, 3-96
 - AND**, 3-85, 3-87
 - Ch1, Ch2 ...**, 3-73, 3-75, 3-77, 3-79, 3-82, 3-84, 3-87, 3-89, 3-98
 - Clock Source**, 3-89
 - Data Source**, 3-89
 - Define Inputs**, 3-84, 3-87, 3-89, 3-90
 - Define pattern type, 3-85, 3-87
 - Delay time, 3-96
 - Either**, 3-73, 3-75, 3-77, 3-79, 3-98
 - Falling edge, 3-87, 3-89
 - FALSE**, 3-85, 3-88
 - Glitch**, 3-73, 3-74
 - Level**, 3-74, 3-78, 3-83
 - Logic**, 3-84, 3-87, 3-88
 - NAND**, 3-85, 3-87
 - Negative, 3-73, 3-75, 3-77, 3-79, 3-98
 - NOR**, 3-85, 3-87
 - OR**, 3-85, 3-87
 - Pattern**, 3-84
 - Polarity and Width**, 3-73, 3-75, 3-77
 - Positive, 3-73, 3-75, 3-77, 3-79, 3-98
 - Pulse**, 3-73, 3-75, 3-77, 3-79, 3-82
 - Rising edge, 3-87, 3-89
 - Runt**, 3-75
 - Set Thresholds**, 3-84, 3-87
 - Set to ECL, 3-80
 - Set to TTL, 3-80
 - Setup/Hold**, 3-88
 - Slew Rate, 3-79
 - Source**, 3-73, 3-75, 3-77, 3-79, 3-82
 - State**, 3-87
 - Thresholds**, 3-76, 3-80
 - Timeout**, 3-82
 - Timer**, 3-82
 - Transition**, 3-79
 - Trig Delay**, 3-96
 - Trigger When**, 3-85, 3-88
 - TRUE**, 3-85, 3-88
 - Width**, 3-77
- A trigger control window, 3-98
- A Trigger level
 - ECL**, 3-65, 3-66
 - TTL**, 3-65, 3-66
 - User**, 3-65, 3-66
- A->B Seq Trigger control window, 3-96, 3-97
 - A Then B**, 3-96, 3-97
 - B Trig Level**, 3-97
 - B trigger level, 3-97
 - Trig Event**, 3-97
 - Trigger events, 3-97
- A->B Trigger Sequence, D-6
- About TDS7000, D-12
- Absolute Reference, 3-125
- AC coupling, Glossary-1
- AC line voltage, trigger input, 3-54, 3-60
- Access Vertical Set Up Help, 3-13
- Accessories, 1-29
 - optional, 1-31
 - Probes, 1-4
 - standard, 1-30
- accessory software, 1-11
- Accuracy, Glossary-1
 - Gain and Offset, 3-146
- Acquiring and Displaying Waveforms, 3-3
- Acquisition, Glossary-1
 - input channels and digitizers, 3-32
 - Interval, Glossary-1
 - Modes, Envelope, 3-47
 - record, 3-34

- sampling (see Sampling), 3-33–3-38
- Acquisition Controls
 - Acquisition Control Background, 3-32
 - Acquisition Hardware, 3-32
 - Aliasing illustrated, 3-27
 - Average, 3-24, 3-28
 - Condition, 3-25
 - Envelope, 3-23, 3-28
 - Equivalent-time Sampling, 3-35
 - Equivalent-Time Sampling, illustrated, 3-36
 - Global Controls, 3-26
 - Hi Res, 3-22, 3-28
 - Intensity, 3-44
 - Interleaving, 3-37
 - Interpolation, 3-37
 - Linear interpolation, 3-27
 - Methods to Check and Eliminate Aliasing, 3-27
 - OFF** (Real Time Only), 3-29
 - Peak Detect, 3-22, 3-28
 - Preventing Aliasing, 3-26
 - Real-time Sampling, 3-35
 - record length, 3-34
 - repetitive signal, 3-29
 - Roll, 3-25
 - RUN/STOP, 3-28
 - Run/Stop Button Only, 3-25
 - Sample, 3-22, 3-28
 - sample interval, 3-34
 - Sampling and acquisition mode, 3-35
 - Sampling mode selection, 3-36
 - Sampling Modes, 3-33
 - Sampling Process, 3-33
 - Select the Acquisition Mode, 3-28
 - Set the Stop Mode, 3-28
 - Set Waveform Count (Average and Envelope only), 3-28
 - Sin(x)/x interpolation, 3-37
 - SINGLE, 3-25, 3-28
 - Single Sequence, 3-25
 - Single Sequence OFF, 3-28
 - To Disable Roll Mode, 3-32
 - To Enable Roll Mode, 3-31
 - To Select an Acquisition Mode, 3-28
 - To Select Real-time or Equivalent-time Sampling, 3-29
 - To Set Acquisition Modes, 3-27
 - To Set Roll Mode, 3-31
 - To Single Sequence Roll Mode, 3-31
 - To Start & Stop Acquisition, 3-29
 - To Start Acquiring, 3-30
 - To Stop Acquiring, 3-30
 - To Take a Single Acquisition, 3-30
 - To Turn Off Roll Mode Acquisitions, 3-31
 - trigger point, 3-34
 - Untriggered Roll, 3-25
 - Untriggered Roll with Single Sequence, 3-25
 - using, 3-22
 - Using Fast Acquisition Mode, 3-38
 - Using FastFrame, 3-46
 - Waveform Record, 3-34
- Acquisition controls, waveform database, 3-24, 3-28
- Acquisition Mode, D-5
- Acquisition mode, spectral math, 3-190
- Acquisition modes, Incompatible with Fast Acquisitions, 3-38
- Acquisition Overview, 3-32
- Acquisition Preview, 3-103
- Acquisition setup, D-4
- Address, Tektronix, xv
- Advanced Triggering, 3-68
- Aliasing, 3-26, 3-190, Glossary-1
 - eliminating, 3-27
 - Illustrated, 3-27
 - recognizing, 3-190
- All, D-9
- Amplitude, B-1, D-9, Glossary-1
- Analyzer Control Locks, 3-169
- AND, Glossary-1
- AND, A Trigger control window, 3-85, 3-87
- Annotate Waveforms On Screen, 3-122
- Annotated display, 3-123
- Appearance, D-7
- Applications
 - derivative math waveforms, 3-157
 - integral math waveforms, 3-159
 - optional, 1-12
- applications, 1-12
- Area, B-1, D-9, Glossary-1
- Attenuation, Glossary-1
- Attenuation, input, D-4
- Auto-increment file name, 3-206, 3-210, 3-216, 3-231
- Auto-increment filename, 3-206
- AutoBright, 3-115
- Automated measurements, 3-122
 - of FFT math waveforms, 3-191
- Automatic Measurements, 3-122
- Automatic measurements
 - high and low levels defined, B-5
 - levels used in taking, B-4, B-6
 - reference levels defined, B-5
 - reference levels defined (eye pattern/optical), B-6
- Automatic trigger mode, 3-55, 3-61, Glossary-2
- Autoset, 3-13, D-4, Glossary-2
 - How to execute, 3-11
 - undoing, 3-11

- undo, D-5
- Autoset Undo, 3-11
- Autoset undo, D-3
- AUX Out configuration, D-12
- Auxiliary trigger, 3-54, 3-60
- Average, 3-24, 3-28, 3-47
 - Incompatible with Fast Acquisitions, 3-38
- Average acquisition mode, Glossary-2
- Averaging, Glossary-2
 - spectral math, 3-190

B

- B Event (Delayed) Trigger Setup, D-6
- B Trig Level**, A->B Seq Trigger control window, 3-97
- B Trigger control window, **Source**, 3-98
- B trigger level, A->B Seq Trigger control window, 3-97
- backing up user files, 1-10
- Backlight timeout, 3-116, D-8
- Bandwidth, D-4, Glossary-2
- Bitmap, file format, 3-223
- Blackman-Harris, 3-178, 3-180, 3-185, 3-197
- Burst Width, B-1, D-9
- Button, ZOOM, 3-110
- button
 - DELAY**, 3-58
 - FORCE TRIG**, 3-66
 - SET LEVEL TO 50%**, 3-60
 - SINGLE TRIG**, 3-67
 - ZOOM**, 3-109

C

- Calibrate Probes, 3-146
- Calibrate the Oscilloscope, 3-142
- Calibration Instructions, 3-142
- Calibration Status, 3-142, 3-147
- CD-ROMs, optional applications, 1-12
- Center, 3-172
- Ch1 - Ch2, D-11
- Ch1 * Ch2, D-11
- Ch1, Ch2 ...**, A Trigger control window, 3-73, 3-75, 3-77, 3-79, 3-82, 3-84, 3-87, 3-89, 3-98
- Ch3 - Ch4, D-11
- Ch3 * Ch4, D-11
- CH3 signal output, 2-9
- Channel, Glossary-2, Glossary-6, Glossary-10
 - Readout, 3-113
 - Trigger input, 3-54, 3-60
- channel, 3-123, 3-124
- Channel configuration, 3-33

- Channel reference indicator, Glossary-2
- Channel-probe deskew, 3-148, Glossary-2
- Channels
 - Deskew, 3-148
 - digitizer configuration, 3-32
 - shared horizontal window, 3-20
 - shared parameters, illustrated, 3-20
- Circuit loading, Glossary-3
- Cleaning
 - exterior, C-1
 - flat panel display, C-1
- Clear all references and setups, 3-220
- Clipping
 - derivative math waveforms, 3-159
 - how to avoid, 3-159, 3-160
 - integral math waveforms, 3-160
- Clock Source**, A Trigger control window, 3-89
- Color
 - Math, 3-115
 - Palette, 3-115
 - palette, D-7, D-8
 - Reference, 3-115
- Color Palette, 3-44, 3-115, 3-119
 - changing, 3-119
 - definition, 3-115
- Color palette, D-7, D-8
 - definition, D-7, D-8
- Colors, D-7
- Comm, D-9
- Comm setup, D-6
- Comm triggering, 3-99
- Comm, trigger, D-6
- Communication, remote, 3-243
- Configuration
 - software installation, 1-11-1-13
 - System, 1-5
- Connect Input Signal, 3-8
- Connecting and Conditioning Your Signals, 3-5
- connecting peripherals, 1-6
- connection to a LAN, 1-14
- connection to a network, 1-14
- connectivity tools, 2-2
- Contacting Tektronix, xv
- Contents and Index, D-12
- Control knob, Glossary-2
- Control window, Glossary-2
 - A Trigger, 3-73, 3-75, 3-79, 3-82, 3-84, 3-87, 3-88, 3-96
 - A->B Seq Trigger, 3-96, 3-97
 - B trigger, 3-98
- Controlling data input and output, 3-205
- Copy, D-3
- Copy a waveform, 3-234

- Copy Setup, D-3
- Copy waveforms, 3-234
- Copying waveforms, 3-223
- Coupling, 3-6, D-4
 - Ground, Glossary-5
 - Trigger, 3-57
- creating, emergency startup disk, 1-10
- Creating and Using Math Waveforms, 3-153
- Cross Hair, graticule, 3-120
- Cross-Hair, graticule, D-7
- Crossing %, B-3, D-9
- Cursor, 3-131
 - Controls, D-8
 - marker length, 3-137
 - Measurements, 3-122, 3-132, 3-200
 - Mode, D-8
 - Position, 3-136, D-8
 - Sources, 3-136
 - Tracking, 3-137
 - Type, 3-136, D-8
 - Types, 3-133
 - Units, 3-135
- Cursor Controls Window, 3-136
- Cursor Measurements, 3-200
- Cursor menu
 - Cursor Controls, D-8
 - Cursor Mode, D-8
 - Cursor Position, D-8
 - Cursor Setup, D-8
 - Cursors On, D-8
 - H-bars, D-8
- Cursor readout, V-Bars, 3-200
- Cursors, 3-132, Glossary-3
 - On, D-8
 - Using, 3-133
 - with derivative waveforms, 3-158, 3-167
 - with FFT waveforms, 3-191, 3-200
- Cursors menu
 - Cursor Type, D-8
 - Independent, D-8
 - Paired, D-8
 - Split, D-8
 - Track, D-8
 - V-bars, D-8
- Customer Feedback, D-12
- Customize Measurements, 3-123
- Customizing the display, 3-114
- Cycle Area, B-1, D-9, Glossary-3
- Cycle distortion, B-4, D-9
- Cycle Mean, B-1, D-9, Glossary-3
- Cycle RMS, B-1, D-9, Glossary-3

D

- Data, controlling input and output, 3-205
- Data input/output, 3-205
 - all settings are retained, 3-206
 - avoiding setup/waveform mismatches, 3-206
 - begin your chart, 3-233
 - bitmap, file format, 3-223
 - copy your file, 3-237
 - copying waveforms, 3-223
 - delete a reference waveform file, 3-221
 - delete the file, 3-222
 - delete the reference, 3-221
 - display the reference control window, 3-214, 3-218, 3-221
 - display the setups control window, 3-208, 3-211
 - display your reference waveform, 3-220
 - export your file, 3-230
 - exporting and copying waveforms, 3-223
 - file formats, 3-223
 - find the file directory, 3-222
 - find the source directory, 3-211, 3-219
 - find your file, 3-222
 - finish the chart, 3-233
 - hardcopy formats, 3-239
 - image, 3-239
 - import the waveform data, 3-232
 - JPEG, file format, 3-223
 - label the waveform, 3-215
 - margins, 3-238
 - MathCad, file format, 3-223
 - MathLab, file format, 3-223
 - name a destination, 3-209
 - name the file, 3-231
 - name your setup, 3-209, 3-210
 - numeric, file format, 3-223
 - orientation, 3-238
 - page setup window, 3-240
 - palette, 3-239
 - paper, 3-238
 - PNG, file format, 3-223
 - print preview window, 3-241
 - print window, illustration, 3-238
 - printing waveforms, 3-238
 - recall a reference waveform from a file, 3-219
 - recall setup from a file, 3-211
 - recall the setup, 3-211
 - recall the waveform, 3-218
 - recall your setup, 3-212
 - recall your waveform, 3-220
 - remote communication, 3-243

- retaining current settings, 3-206
- save all waveforms to files, 3-216
- save the file, 3-231
- save the setup, 3-208
- save the waveform to a file, 3-216
- save the waveform to a reference, 3-215
- save your setup, 3-210
- save your waveform, 3-216
- saving and recalling a setup, 3-205
- saving and recalling waveforms, 3-213
- select a destination, 3-216, 3-230
- select directory and name file, 3-216
- select for copy, 3-234
- select for export, 3-224
- select setup for copy, 3-234
- select setup for export, 3-225
- select the waveform to save, 3-214
- select your setup, 3-212
- select your waveform, 3-220
- setup to copy images, 3-235
- setup to copy measurements, 3-237
- setup to copy waveforms, 3-236
- setup to export histograms, 3-229
- setup to export images, 3-226
- setup to export measurements, 3-229
- setup to export waveforms, 3-227
- specify a line-graph chart, 3-233
- spreadsheet, file format, 3-223
- text, file format, 3-223
- to clear references, 3-220
- to copy your waveform, 3-234
- to date/time stamp hardcopies, 3-242
- to display the date and time, 3-242
- to export your waveform, 3-224
- to get the current time, 3-242
- to preview the page, 3-240
- to print from front panel, 3-238
- to print from menu bar, 3-238
- to recall your setup, 3-211
- to recall your waveform, 3-218
- to save to a file, 3-209
- to save your setup, 3-208
- to save your waveform, 3-214
- to set the date and time, 3-242
- to set up the page, 3-238
- to use an exported waveform, 3-232
- using auto-increment filename, 3-206
- view, 3-239
- Data Source**, A Trigger control window, 3-89
- Date and time
 - Display, 3-116, D-8
 - displaying, 3-242
 - Set, 3-116
 - setting, 3-242
- Date/time, on hardcopies, 3-242
- dB**, 3-195
- DC coupling, Glossary-3
- DC offset, with math waveforms, 3-160
- Deassign Multipurpose Knobs, D-12
- Default Setup**, How to execute, 3-12
- Define Inputs**, A Trigger control window, 3-84, 3-87, 3-89, 3-90
- Define pattern type, A Trigger control window, 3-85, 3-87
- Defining and displaying waveforms, 3-104
- Degree**, 3-196
- Delay, D-9
- DELAY** button, 3-58
- Delay measurement, Glossary-3
- Delay Mode On, D-5
- Delay time, Glossary-3
 - A Trigger control window, 3-96
- Delayed Runs After Time, 3-58
- Delayed time base, Incompatible with DPO, 3-38
- Delayed trigger, 3-58
 - How to set up, 3-96
- Delayed triggerable on events, 3-58
- Delete All Refs, D-1
- Derivative math waveform, 3-158
 - applications, 3-157
 - derivation of, 3-158
 - procedure for measuring, 3-158, 3-167
 - record length of, 3-158
- Description
 - key features, 1-1
 - Product, 1-1
- Deskew, 3-148, D-4, Glossary-2
 - Channels, 3-148
 - Vertical controls window, 3-148
- diagnostics, D-12
- Differentiation
 - of a derivative, 3-157
 - waveform, 3-157
- Digitizing, Glossary-3
 - process, defined, 3-33–3-38
- Display
 - Date and Time, D-8
 - System, Glossary-3
- display
 - customizing, 3-114
 - elements, 3-102
 - format, 3-115, D-7
 - mode, 3-114
 - persistence, D-7
 - settings, 3-114
 - setup, 3-117, D-7

- style, 3-114, D-7
- styles, 3-117
- Display area, zoom, D-5
- display control, 3-103
- Display control window
 - Dots**, 3-116
 - Infinite Persistence**, 3-116
 - Variable Persistence**, 3-116
 - Vectors**, 3-116
- Display Controls, Intensity, 3-44
- Display menu
 - Appearance, D-7
 - color palette, D-7, D-8
 - Colors, D-7
 - Cross-Hair, D-7
 - Display Date and Time, D-8
 - Display Format, D-7
 - Display Persistence, D-7
 - Display Setup, D-7
 - Display Style, D-7
 - Display Trigger T, D-8
 - Dots, D-7
 - Frame, D-7
 - Full, D-7
 - Graticule Style, D-7
 - Grid, D-7
 - Infinite Persistence, D-7
 - Intensified Samples, D-7
 - Intensity**, 3-44
 - LCD Backlight Enabled, D-8
 - Linear, D-7
 - monochrome gray, D-7, D-8
 - monochrome green, D-7, D-8
 - n, D-7, D-8
 - No Persistence, D-7
 - Objects, D-7
 - persistence controls, D-7
 - reset all, D-7
 - Screen Text, D-7
 - Sin(x)/x, D-7
 - spectral grading, D-7, D-8
 - temperature grading, D-7, D-8
 - user palette, D-7, D-8
 - Variable Persistence, D-7
 - Vectors, D-7
 - Waveform Intensity**, 3-44
 - Waveform Interpolation, D-7
 - XY, 3-45, D-7
 - XYZ, 3-45, D-7
 - YT, 3-45, D-7
- Display On/Off, D-1, D-3, D-10, D-11
- Display Trigger T, D-8
- Displaying Waveforms, 3-101
 - Access the Display Setup Dialog Box, 3-117
 - Acquisition Preview, 3-103
 - Adjust the Horizontal Reference, 3-108
 - backlight timeout, 3-116
 - Change Graticule Style, 3-120
 - Change Waveforms Colors, 3-119
 - Checking the Zoom Scale and Position, 3-113
 - color palette, 3-115
 - Customizable Display Elements, 3-114
 - Customize Graticule & Waveforms, 3-119
 - Customizing the Display, 3-114
 - date and time, 3-116
 - Defining and displaying waveforms, 3-104
 - Display and Acquisition Controls, 3-105
 - display control, 3-103
 - display elements, 3-102
 - display format, 3-115
 - display mode, 3-114
 - display settings, 3-114
 - display style, 3-114
 - dots, 3-114, 3-118
 - Explore the Zoom Controls, 3-108
 - graticule, 3-102, 3-119
 - graticule area, 3-102
 - graticule style, 3-114
 - horizontal position, 3-104, 3-106
 - Horizontal Position and the Horizontal Reference, 3-105
 - horizontal record length, 3-104
 - Horizontal Reference, 3-102, 3-106
 - horizontal scale, 3-104
 - Horizontal-scale readout, 3-102
 - Infinite Persistence, 3-116, 3-118
 - intensified samples, 3-114
 - intensity, 3-115
 - Interpolation, 3-115, 3-117
 - LCD Backlight, 3-116
 - Linear, 3-118
 - Linear interpolation, 3-117
 - math colors, 3-115
 - Mouse, 3-106
 - Mouse and Touch Screen Operation, 3-106
 - Normal and Persistence Displays, 3-116
 - Operations on the Timebase, 3-105
 - Operations on Waveforms, 3-104
 - Operations performed based on the waveform type, 3-104
 - persistence, 3-118
 - persistence displays, 3-116
 - Quick Adjust the Timebase (Zoom), 3-108
 - record length, 3-104

reference colors, 3-115
 Reset Zoom, 3-113
 scale, 3-104
 screen saver, 3-116
 screen text, 3-114
 Select a Persistence Mode, 3-118
 Select the Display Persistence, 3-118
 Select the Display Style, 3-118
 Select Zoom, 3-110
 Set Date and Time, 3-116
 Set Display Styles, 3-117
 Set Horizontal Display Parameters, 3-107
 Set Up Zoom, 3-112
 Set Vertical Display Parameters, 3-107
 Setting Zoom Controls, 3-109
 Sin(x)/x interpolation, 3-117
 Sine(x)/x, 3-118
 To Display Waveforms in the Main Graticule, 3-107
 To Zoom Waveforms, 3-109
 Touch Screen, 3-103, 3-106
 trigger level marker, 3-115
 trigger T, 3-115
 Using Display Controls, 3-114
 Using the Display, 3-103
 Using the Waveform Display, 3-102
 using zoom with waveforms, 3-109
 Variable Persistence, 3-116, 3-118
 Vectors, 3-114, 3-118
 vertical offset, 3-104
 vertical position, 3-104
 vertical scale, 3-104
 Waveform Display, 3-103
 waveform intensity, 3-115
 waveform interpolation, 3-115
 Waveforms, 3-119
 XY, 3-115
 XYZ, 3-115
 YT, 3-115
 Zoom, 3-103, 3-104, 3-108
 Zoom a Waveform, 3-111
 Zoom Position, 3-113
 Zoom Reset, 3-113
 Zoom Scale, 3-113
 Displaying waveforms
 graticules, 3-105
 horizontal zoom, 3-113
 intensified samples, 3-118
 vertical zoom, 3-113
 Distal, Glossary-3
 Dots, 3-118, D-7
 dots, 3-114, 3-116
 Dots, Display control window, 3-116
 DPO, Glossary-4

Dragging, Glossary-3
 Dual display setup, 1-14
 Dual graticule, Glossary-4
 duration, 3-169
 Duty cycle, Glossary-8, Glossary-9
 Duty cycle distortion, B-4

E

ECL, 3-74, 3-80, 3-83, 3-89
ECL, A Trigger level, 3-65, 3-66
 Edge
 Setup, D-6
 trigger, 3-55, D-6, Glossary-4
 Edit menu
 Copy, D-3
 Copy Setup, D-3
 Full Screen, D-3
 Graticule, D-3
 Measurement, D-3
 Select for Copy, D-3
 Waveform, D-3
Either, A Trigger control window, 3-73, 3-75, 3-77,
 3-79, 3-98
 Envelope, 3-23, 3-28, 3-47
 Incompatible with Fast Acquisitions, 3-38
 Envelope acquisition mode, 3-47, Glossary-4
 environment requirements, 1-6
 Equation Editor, D-11
 Equivalent Time Auto, D-5
 Equivalent-time sampling, 3-35, 3-47
 random, Glossary-4
 Erase all references and setups, 3-220
 Error log, D-12
 Ethernet, 3-243
 Excel, 3-232
 exiting the application, 1-12
 Export, D-2
 save format, 3-223
 Export Setup, D-2
 Export waveforms, 3-224
 Exporting files using PRINT button, 3-230
 Exporting waveforms, 3-223
 Ext ratio, D-9
 Ext ratio (dB), D-9
 Ext ratio %, D-9
 External reference, 2-10, D-12
 External signals, D-12
 Extinction ratio, B-3
 Extinction ratio %, B-3
 Extinction ratio dB, B-3
 Eye base, B-3, D-9

Eye height, B-3, D-9
Eye top, B-3, D-9
Eye width, B-3, D-9

F

Fall Time, B-1, D-9, Glossary-4
Falling edge, A Trigger control window, 3-87, 3-89
FALSE, A Trigger control window, 3-85, 3-88
Fast Acquisition, 3-38, 3-47

- Automatic Selection, 3-39
- Normal DSO and Fast Acquisition Displays, 3-40
- To Adjust the Intensity, 3-44
- To Enable Fast Acquisitions Mode, 3-42
- To Select the Color Palette, 3-44
- To Select the Format, 3-45
- To Set Display Format, 3-45
- To Set the Display Readout Options, 3-43
- To Set the Style, 3-43
- To Turn Fast Acquisitions On and Off, 3-42
- Using Fast Acquisition Mode, 3-38
- Using Fast Acquisitions, 3-39
- Vs. Normal DSO mode (illustrated), 3-41
- Waveform Capture Rate, 3-39

Fast Acquisitions, D-5
Fast Acquisitions mode, Modes incompatible with, 3-38
Fast Fourier Transforms, description, 3-168
FastFrame, 3-46, 3-123, 3-155

- Controls, D-5
- FastFrame Time Stamp, illustrated, 3-51
- Incompatible with Fast Acquisitions, 3-38
- interactions, 3-47
- RUN/STOP, 3-47
- Select the FastFrame and Time Stamps Selection Controls, 3-50
- Select the Frame to View, 3-49
- Select the Reference Frame, 3-50
- Set Frame Count, 3-48
- Set Frame Length, 3-48
- Setup, D-5
- Time Stamping Frames, 3-49
- To Lock the Reference Position Frames, 3-51
- To Set FastFrame Mode, 3-48
- Turn Readouts On or Off, Time Stamps, 3-49
- Using FastFrame Acquisitions, 3-47

FastFrame Mode, Using, 3-48
FastFrame Setup, Horizontal menu, 3-48, 3-51
FFT math waveform

- automated measurements of, 3-191
- phase suppression, 3-196
- procedure for displaying, 3-193

procedure for measuring, 3-191, 3-200
File formats, 3-223
File menu

- 1 Recent Setup File !, D-2
- Delete All Refs, D-1
- Display On/Off, D-1
- Export, D-2
- Export Setup, D-2
- Full Screen, D-2
- Graticule, D-2
- Instrument Setup, D-1
- Label, D-1
- Measurements, D-2
- Minimize, D-2
- Page Setup, D-1
- Position/Scale, D-1
- Print, D-1
- Print Preview, D-1
- Recall Default Setup, D-1
- Recall Wfm, D-1
- Reference Setup, D-1
- Reference Waveforms, D-1
- Run Application, D-1
- save waveform, D-1
- Save Wfm, D-1
- Select for Export, D-2
- Shutdown, D-2
- Waveform, D-2

Firmware, upgrade, 1-3
Flat panel display, cleaning, C-1
Flattop2 window, 3-178, 3-180, 3-187
Flexible Control Access, 3-7
FORCE TRIG button, 3-66
frame

- graticule, 3-120, D-7
- Horizontal menu, 3-49

Frame Count, Horizontal menu, 3-48
Frame Length, Horizontal menu, 3-48
Frame, Horizontal menu, 3-50
Frequency, B-1, D-9, Glossary-4
Frequency Domain Controls, 3-168
Front Panel, Triggering, 3-58
Front-Panel controls, INTENSITY, 3-44
full, graticule, 3-120, D-7
Full Screen, D-2, D-3
fuses, 1-8

G

gate controls, 3-170
Gated Measurements, Glossary-4
Gating, 3-130, D-9

Gating Controls, 3-168
 Gaussian window, 3-178, 3-180, 3-182
 General purpose knob, Glossary-7
 Glitch either trigger, Glossary-5
 Glitch negative trigger, Glossary-4
 Glitch Setup, D-6
 Glitch trigger, 3-68, D-6, Glossary-4
 How to set up, 3-73
Glitch, A Trigger control window, 3-73, 3-74
 GPIB, 3-243, Glossary-5
 Configuration, D-11
 remote communication, 3-243
 Graticule, 3-102, D-2, D-3, Glossary-5
 100% zoom, D-5
 50/50% zoom, D-5
 80/20% zoom, D-5
 area, 3-102
 Measurements, 3-122
 Style, 3-114, 3-120, D-7
 Zoom, D-5
 Graticule Size button, 3-105
 Graticule Split, 3-112
 Graticules, 3-105
 grid graticule, 3-120, D-7
 Ground coupling, Glossary-5
GroupDelay, 3-196

H

Hamming window, 3-178, 3-180, 3-184, 3-197
 Hanning window, 3-178, 3-180, 3-185, 3-197
 Hardcopy, Glossary-5
 Hardcopy formats, 3-239
 H-bars, D-8
 Help, 3-245
 For In-depth Contextual Overviews, 3-246
 How to Use Online Help, 3-245
 To Dig Deeper, 3-247
 To Enable Full-Text Search, 3-248
 help, how to get, 3-13
 Help menu, D-12
 About TDS7000, D-12
 Contents and Index, D-12
 Customer Feedback, D-12
 Help on Window, D-12
 Restore Help, D-12
 Specifications, D-12
 Technical Support, D-12
 Help on Window, D-12
 Hi Res, 3-22
 acquisition mode, Glossary-5
 Incompatible with Fast Acquisitions, 3-38
 High, B-1, Glossary-5
 High Level, D-9
 High/Low Method, 3-124
 histogram, 3-129
 limit controls, 3-141
 histogram counting
 resetting, 3-140
 starting, 3-140
 Histogram mean, 3-129
 Histogram Measurements, D-10
 Histogram Setup Window, 3-140
 histograms, 3-47, 3-138, 3-152
 Hits in Box, B-2, D-10
 Holdoff, D-6
Holdoff, A Trigger, 3-64
 Holdoff, trigger, 3-56, Glossary-5
 Horiz/Acq, Run/Stop, D-5
 Horiz/Acq menu
 Acquisition Mode, D-5
 Autoset, D-4
 Delay Mode On, D-5
 Equivalent Time Auto, D-5
 Fast Acquisitions, D-5
 FastFrame Controls, D-5
 FastFrame Setup, D-5
 Horizontal/Acquisition Setup, D-4
 Position/Scale, D-5
 Resolution, D-5
 Roll Mode Auto, D-5
 Zoom Controls, D-4
 Zoom Setup, D-5
 Horizontal
 Acquisition Window Considerations, 3-18
 Acquisition Window, illustrated, 3-18
 Bar cursors, Glossary-5
 delay, 3-95
 position, 3-57, 3-104, 3-105
 record length, 3-104
 scale, 3-19, 3-104
 Horizontal cursors, 3-132
 Horizontal menu
 FastFrame Setup, 3-48, 3-51
 Frame Count, 3-48
 Frame Length %, 3-48
 Frame %, 3-49, 3-50
 Horizontal offset, overview, 3-18
 Horizontal Reference, 3-102, 3-105
 Horizontal reference point, Glossary-5
 horizontal scale, 3-104
 Horizontal scale and offset, setting up, overview, 3-18
 Horizontal Scale vs. Record Length vs. Sample Interval
 vs. Resolution, 3-19

Horizontal zoom, 3-113
Horizontal/Acquisition Setup, D-4
Horizontal-scale readout, 3-102

I

Image, printing, 3-239
Impulse Response Testing, 3-177
Incoming Inspection Procedure, 1-17–1-28
 Test Equipment, 1-17
Independent, D-8
Independent vs. Shared Window, 3-20
Index, Reference, 3-1
Infinite Persistence, 3-118, D-7
 Display control window, 3-116
Initialize, Glossary-6
Input, 3-205
Input Conditioning Background, 3-13
input coupling, 3-9
 AC, 3-9
 DC, 3-9
 GND, 3-9
Installation, 1-5–1-16
 incoming inspection procedure, 1-17
 option, D-12
 software installation, 1-11–1-13
Instrument Diagnostics, D-12
Instrument id, D-12
Instrument Setup, D-1
Integral math waveform, 3-160
 applications, 3-159
 derivation of, 3-160
 record length of, 3-160
Integration, Waveform, 3-159
Inten samp, 3-118
Intensified samples, 3-118
intensified samples, D-7
Intensity, 3-44, Glossary-6
 Display menu, 3-44
 Waveform, 3-115
Interleaving, 3-37, Glossary-6
Internal reference, 2-10, D-12
Interpolation, 3-37, 3-115, 3-117, D-7, Glossary-6
 Incompatible with DPO, 3-38
Introduction, to this manual, xiii

J

Jitter 6 sigma, B-4, D-9
Jitter pk-pk, D-9
Jitter pk-pk measurement, B-3
Jitter RMS, B-4

Jitter rms, D-9
JPEG, file format, 3-223

K

Kaiser-Bessel window, 3-178, 3-180, 3-185
Knob, Glossary-6
 General purpose, Glossary-7
 multipurpose, 3-135
 resolution, Glossary-6
 Trigger **MAIN LEVEL**, 3-58

L

Label, D-1, D-3, D-11
Label the waveform, 3-215
LAN, enabling, 1-14
LAN connection, 1-14
LCD Backlight Enabled, D-8
LCD backlight timeout, 3-116, D-8
Level presets, 3-65
 A Trigger, 3-66
Level, A Trigger control window, 3-74, 3-78, 3-83
Level, Trigger, 3-57
line, trigger input, 3-54, 3-60
linear, 3-118, D-7
Linear interpolation, 3-37, 3-117, Glossary-6
Lock
 all zoom, D-5
 zoom, D-5
Lock
 live zoom, D-5
 None zoom, D-5
Logic Pattern Setup, D-6
Logic Pattern, trigger, D-6
Logic State Setup, D-6
Logic State, trigger, D-6
Logic trigger, 3-70
 Definitions, 3-70
 Pattern, Glossary-6
 State, 3-69, 3-70, Glossary-6
Logic triggering, 3-68
Logic, A Trigger control window, 3-87, 3-88
 Logic, 3-84
 Pulse, 3-73
Logic, Main Trigger menu, **Pulse**, 3-79, 3-82
Low, B-1, Glossary-6
Low Frequency Compensation, 3-148
Low Level, D-9
low method, 3-124

M

- Magnitude Spectrum, D-11
- Magnitude Verses Frequency, 3-168
- Main Trigger menu
 - Polarity**, 3-75, 3-77, 3-79, 3-98
 - Pulse**, 3-79, 3-82
 - Set to 50%**, 3-60
 - State**, 3-87, 3-88
 - True for less than**, 3-86
 - True for more than**, 3-86
 - Width**, 3-73, 3-76
- Manuals
 - part numbers, 1-30
 - related, xiv
- Margins, printing, 3-238
- Mask testing, 3-152
 - example, 3-201
 - hookup, 3-201
- Math, overview, 3-153
- Math color, 3-115
- Math menu
 - Ch1 - Ch2, D-11
 - Ch1 * Ch2, D-11
 - Ch3 - Ch4, D-11
 - Ch3 * Ch4, D-11
 - Display On/Off, D-10, D-11
 - Equation Editor, D-11
 - Label, D-11
 - Magnitude Spectrum, D-11
 - Math Setup, D-10, D-11
 - Phase Spectrum, D-11
 - Position/Scale, D-10, D-11
 - Set Math Averages, D-11
 - Spectral Controls, D-11
 - Spectral Setup, D-11
- Math Setup, D-10, D-11
- Math Waveforms, 3-123
 - Apply Averaging, 3-163
 - Consider the Source, 3-164
 - Creating and Using Math Waveforms, 3-153
 - Cursor Measurements, 3-158
 - Defining Math Waveforms, 3-154
 - Defining Spectral Math Waveforms, 3-168
 - See also* Spectral Math
 - derivative. *See* Derivative math waveform
 - Derivative Math Waveform, illustration, 3-158
 - Differentiation, 3-157
 - Disallowed in DPO, 3-38
 - Display the Math Control Window, 3-161
 - Expression Syntax, 3-157
 - FastFrame, 3-155
 - Functional transformation of an acquired waveform, illustration, 3-154
 - How to Create, 3-155
 - How to manage displaying, 3-164
 - Incompatible with Fast Acquisitions, 3-38
 - integral. *See* Integral math waveform
 - Offset, Position, and Scale, 3-159
 - Operations on Math Waveforms, 3-163
 - Peak-Peak Amplitude Measurement of a Derivative Waveform, illustration, 3-159
 - Select a Function, 3-162
 - Select a Math Waveform, 3-161
 - Select and Display, 3-165
 - Set Scale and Position, 3-165
 - Source Dependencies, 3-156
 - Sources, 3-156
 - Spectral analysis of an impulse, illustration, 3-154
 - Spectral Math Waveforms, 3-168
 - Take Automatic Measurements, 3-166
 - Take Cursor Measurements, 3-167
 - To Define a Math Waveform, 3-160
 - To Define an Expression, 3-161
 - To Define/Edit a Math Expression, 3-162
 - To use, 3-164
 - To Use Math Waveforms, 3-164
 - Using Math, 3-155
 - Using Math Waveforms, 3-164
 - Waveform Differentiation, 3-157
 - Waveform Integration, 3-159
- math waveforms, 3-124
- MathCad, file format, 3-223
- MathLab, file format, 3-223
- Max, 3-128
- Maximum, B-1, D-9, D-10, Glossary-7
- Mean, 3-128, B-1, B-2, D-9, D-10, Glossary-7
- Mean +- 1 StdDev, B-3
- Mean +- 2 StdDev, B-3
- Mean +- 3 StdDev, B-3
- Measure menu
 - all, D-9
 - Amplitude, D-9
 - Area, D-9
 - Burst Width, D-9
 - Comm, D-9
 - crossing %, D-9
 - Cycle Area, D-9
 - cycle distortion, D-9
 - Cycle Mean, D-9
 - Cycle RMS, D-9
 - Delay, D-9
 - ext ratio, D-9
 - ext ratio (dB), D-9

- ext ratio %, D-9
- eye height, D-9
- eye top, D-9
- eye width, D-9
- Fall Time, D-9
- Frequency, D-9
- Gating, D-9
- High Level, D-9
- Histogram Measurements, D-10
- Hits in Box, D-10
- jitter 6 sigma, D-9
- jitter pk-pk, D-9
- jitter rms, D-9
- Low Level, D-9
- Maximum, D-9, D-10
- Mean, D-9, D-10
- Mean +-1 StdDev, D-10
- Mean +-2 StdDev, D-10
- Mean +-3 StdDev, D-10
- Measurement Setup, D-9
- Median, D-10
- Minimum, D-9, D-10
- More, D-9
- Neg Duty Cycle, D-9
- neg duty cycle, D-9
- Neg Overshoot, D-9
- Negative Width, D-9
- noise pk-pk, D-9
- noise RMS, D-9
- off, D-9
- Peak Hits, D-10
- Peak to Peak, D-10
- Peak-to-Peak, D-9
- Period, D-9
- Phase, D-9
- Pos Duty Cycle, D-9
- Pos Overshoot, D-9
- Positive Width, D-9
- Reference Levels, D-9
- Reset Histograms, D-10
- reset statistics, D-9
- Rise Time, D-9
- RMS, D-9
- s/n ratio, D-9
- Snapshot, D-9
- Standard Deviation, D-10
- statistics, D-9
- statistics controls, D-9
- Time, D-9
- Value Count, D-10
- value mean, D-9
- Waveform Histograms, D-10
- Measurement, D-3, Glossary-7
 - Amplitude, B-1, Glossary-1
 - Area, B-1, Glossary-1
 - Burst Width, B-1
 - Burst width, Glossary-2
 - crossing %, B-3
 - Cycle Area, B-1
 - Cycle area, Glossary-3
 - Cycle Mean, B-1, Glossary-3
 - Cycle RMS, B-1, Glossary-3
 - Delay, Glossary-3
 - Duty cycle, Glossary-8, Glossary-9
 - duty cycle distortion, B-4
 - extinction ratio, B-3
 - extinction ratio %, B-3
 - extinction ratio dB, B-3
 - eye base, B-3
 - eye height, B-3
 - eye top, B-3
 - eye width, B-3
 - Fall Time, B-1
 - Frequency, B-1, Glossary-4
 - Gated, Glossary-4
 - High, B-1, Glossary-5
 - Hits in Box, B-2
 - jitter 6 sigma, B-4
 - jitter pk-pk, B-3
 - jitter RMS, B-4
 - Low, B-1, Glossary-6
 - Maximum, B-1, Glossary-7
 - Mean, B-1, B-2, Glossary-7
 - Mean +- 1 StdDev, B-3
 - Mean +- 2 StdDev, B-3
 - Mean +- 3 StdDev, B-3
 - Median, B-2
 - Minimum, B-2, Glossary-7
 - Negative duty cycle, B-2
 - Negative overshoot, B-2
 - Negative Width, B-2
 - noise pk-pk, B-4
 - noise RMS, B-4
 - Overshoot, Glossary-9
 - Peak Hits, B-3
 - Peak-to-Peak, B-2, Glossary-8
 - Period, B-2, Glossary-8
 - Phase, B-2, Glossary-9
 - Pk-Pk, B-3
 - Positive duty cycle, B-2
 - Positive overshoot, B-2
 - Positive width, B-2
 - Propagation delay, B-1
 - quality factor, B-4

- Rise Time, B-2, Glossary-10
- RMS, B-2, Glossary-10
- S/N ratio, B-4
- StdDev, B-2
- Undershoot, Glossary-8
- Waveform Count, B-2
- Width, Glossary-8, Glossary-9
- Measurement Accuracy, Ensuring maximum, 3-141–3-152
- Measurement parameter, Glossary-7
- Measurement Setup, D-9
- Measurement statistics, 3-128, Glossary-7
- Measurement tracking, Glossary-7
- Measurements, D-2
 - automated, 3-122
 - Classes of, 3-121
 - Cursor, 3-132
 - high and low levels defined, B-5
 - levels used in taking, B-4, B-6
 - reference levels defined, B-5
 - reference levels defined (eye pattern/optical), B-6
- Measuring Waveforms, 3-121
 - Absolute Reference, 3-125
 - Access Gating, 3-130
 - Annotate Waveforms On Screen, 3-122
 - Annotated display, 3-123
 - Automatic Measurements, 3-122
 - Calibrate the Oscilloscope, 3-142
 - Change Cursor Position, 3-136
 - channel, 3-123, 3-124
 - Check the Calibration Status, 3-142, 3-147
 - Compensate Probe Timing (Deskew), 3-150
 - Components determining Time cursor readout values, 3-134
 - Connect the Fixture, 3-143
 - Connect the Probe, 3-144
 - Connect the Probe Calibration Fixture, 3-143
 - Cursor, 3-131
 - Cursor Measurements, 3-122
 - Cursor types, 3-132, 3-133
 - Cursor Units Depend on Sources, 3-135
 - Cursors are Display Limited, 3-133
 - Cursors Ignore the Selected Waveform, 3-133
 - Cursors Treat Sources Independently, 3-133
 - Customize Measurements, 3-123
 - Display Measurement Statistics, 3-128
 - Display the Calibration Instructions, 3-142
 - Display the Cursor Controls Window, 3-136
 - Enable & Position the Gates, 3-131
 - FastFrame, 3-123
 - gates, 3-123
 - Gating, 3-130
 - Graticule, Cursor and Automatic Measurements, 3-122
 - High/Low Method, 3-124
 - Histogram, 3-124, 3-129
 - Histogram Counting, 3-139
 - Histogram Counting Stays On, 3-139
 - Histogram Measurements, 3-141
 - Histogram Size, 3-139
 - Horizontal cursors, 3-132
 - Horizontal histogram view and measurement data, illustrated, 3-138
 - Indep, cursor, 3-137
 - Low Frequency Compensation, 3-148
 - math waveforms, 3-123, 3-124
 - Max, 3-128
 - Mean, 3-128
 - Measure Part of a Waveform, 3-123
 - Measurement Gating, 3-130
 - Measurement Selection, 3-124
 - Measurement Sources, 3-124
 - Min, 3-128
 - Min-max, 3-125, 3-129
 - Multipurpose knobs, 3-135
 - Number of Measurements, 3-124
 - Open Histogram Setup Window, 3-140
 - Optimize Gain and Offset Accuracy, 3-146
 - Optimizing Measurement Accuracy, 3-141
 - Paired cursors, 3-132
 - Reference Levels Method, 3-125
 - Reference-Level Calculation Methods, 3-126
 - references, 3-123, 3-124
 - Relative Reference, 3-125
 - Remove Measurements, 3-128
 - See Statistics on Measurement Results, 3-123
 - Select a Cursor Type, 3-136
 - Select Measurement Parameters, 3-123
 - Select Measurement Sources, 3-123
 - Select the Cursor Sources, 3-136
 - Select the Waveform, 3-127
 - Set Cursor Tracking, 3-137
 - Set display and reset histogram source and type, 3-140
 - Set histogram display options, 3-141
 - Set histogram limit controls, 3-141
 - Set Measurement Reference Levels, 3-129
 - sources, 3-123, 3-124
 - Split cursors, 3-132
 - Standard Deviation, 3-128
 - statistics, 3-123
 - Take a Snapshot of Measurements, 3-130
 - Take Automatic Measurements, 3-127
 - Take Measurements on a Frame, 3-123

- Taking Automatic Measurements, 3-122
- Taking Cursor Measurements, 3-132
- Taking Histograms, 3-138, 3-152
- To Calibrate Probes, 3-146
- To Compensate Passive Probes, 3-148
- To Compensate the Oscilloscope, 3-142
- To Deskew Channels, 3-148
- To Set the Cursor Sources, 3-136
- To Start and Reset Histogram Counting, 3-140
- To Take Automatic Measurements, 3-127
- Tracking, cursor, 3-137
- Using Automatic Measurements, 3-124
- Using Cursors, 3-133
- Using Histograms, 3-139
- Vertical cursors, 3-132
- Vertical Cursors Measure from the Trigger Point, 3-134
- Zoom, 3-131
- Measuring waveforms
 - histogram mean, 3-129
 - set cursor marker length, 3-137
- Median, B-2, D-10
- Mesial, Glossary-7
- Min, 3-128
- Minimize, D-2
- Minimum, B-2, D-9, D-10, Glossary-7
- Min-max, 3-129
- mode, sampling, 3-33-3-35
- mode, acquisition, D-5
- mode, trigger, D-6
- Monochrome gray, D-7, D-8
- Monochrome green, D-7, D-8
- More, D-9
- Mouse, 3-106
- Multipurpose knobs, 3-135, D-12

N

- NAND, Glossary-7
- NAND, A Trigger control window, 3-85, 3-87
- Neg Duty Cycle, D-9
- Neg Overshoot, D-9
- Negative duty cycle, B-2
- Negative overshoot, B-2
- Negative Width, B-2, D-9
- Negative, A Trigger control window, 3-73, 3-75, 3-77, 3-79, 3-98
- network connection, 1-14
- No Persistence, D-7
- Noise
 - reducing in phase FFTs, 3-196
 - reducing in phase waveforms, 3-176

- Noise pk-pk, D-9
- Noise pk-pk measurement, B-4
- Noise RMS, B-4, D-9
- NOR, Glossary-8
- NOR, A Trigger control window, 3-85, 3-87
- Normal trigger mode, 3-55, 3-61, Glossary-8
- Normal, display, D-7, D-8
- Numeric, file format, 3-223
- Nyquist frequency, 3-190

O

- Objects, display, D-7
- Off, D-9
- OFF** (Real Time Only), Acquisition Controls, 3-29
- Offset, D-4
 - DC. *See* DC Offset
 - vertical, 3-14, 3-159, 3-160
- Online help, 3-245
- operating requirements, 1-6
- Option Installation, D-12
- option installation, 1-13
- option key, 1-13
- option software, 1-13
- Optional accessories, 1-31
- Options key, D-12
- Options list, D-12
- OR, Glossary-8
- OR, A Trigger control window, 3-85, 3-87
- Orientation, printing, 3-238
- Oscilloscope, Glossary-8
- Output, 3-205
- Overshoot, Glossary-9

P

- Page preview, 3-240
- Page Setup, D-1
- Paired, D-8
- Palette, printing, 3-239
- Paper, printing, 3-238
- Pattern trigger, 3-69, 3-84
 - How to setup, 3-84
- Peak Detect, 3-22, 3-28
- Peak detect acquisition mode, Glossary-8
- Peak Hits, B-3, D-10
- Peak to Peak, D-10
- Peak-to-Peak, B-2, D-9, Glossary-8
- Performance Verification
 - Of Functions, 1-18-1-28
 - Self Tests, 1-17-1-28

performance verification, 1-11, 1-12
 Period, B-2, D-9, Glossary-8
 peripheral, connecting, 1-6
 Persistence, 3-116
 Persistence controls, D-7
 Phase, B-2, D-9, Glossary-9
 Phase Spectrum, D-11
 Phase suppression, 3-176
 Phase Verses Frequency, 3-168
 Phone number, Tektronix, xv
 Pixel, Glossary-9
 Pk-Pk, B-3
 Plug&play Software, 1-11-1-16
 PNG, file format, 3-223
Polarity and Width, A Trigger control window, 3-73, 3-75, 3-77
Polarity, Main Trigger menu, 3-75, 3-77, 3-79, 3-98
 Pos Duty Cycle, D-9
 Pos Overshoot, D-9
 Position, vertical, 3-159, 3-160, D-3
 Position/Scale, D-1, D-3, D-5, D-10, D-11
 Positive duty cycle, B-2
 Positive overshoot, B-2
 Positive Width, D-9
 Positive width, B-2
 Positive, A Trigger control window, 3-73, 3-75, 3-77, 3-79, 3-98
 Posttrigger, 3-54, Glossary-9
 powering off, 1-9
 powering on, 1-8
 preferences, D-12
 Pretrigger, 3-54, Glossary-9
 Principal power switch, Glossary-9
 Print, D-1
 Print Preview, D-1
 Print preview, 3-241
 Printing, 3-238
 waveforms, 3-238
 Probe, 1-4
 Accessories, 1-4
 Cal, D-4
 Calibrate, 3-146
 Calibration Fixture, 3-143
 compensate timing, 3-150
 Compensation, Glossary-9
 Definition, Glossary-9
 Low Frequency Compensation, 3-148
 Probe-channel deskew, 3-148, Glossary-2
 Probes and Signal Connection, 3-5
 Product
 accessories, 1-29
 Description, 1-1
 software, 1-2

Product support, contact information, xv
 programmer help, 1-11
 Propagation delay, B-1
 Proximal, Glossary-9
 Pulse trigger, Glossary-10
 Pulse triggering, 3-68
Pulse, A Trigger control window, 3-73, 3-75, 3-77, 3-79, 3-82

Q

Q factor, B-4
 Quality factor, B-4, D-9
 Quantizing, Glossary-10
 quitting the application, 1-12

R

Radian, 3-196
 Range, vertical input, 3-14
 Readout
 Channel, 3-113
 cursor, V-Bars, 3-200
 Trigger, 3-62
 Real-time sampling, 3-35, Glossary-10
 Recall Default Setup, D-1
 Recall Wfm, D-1
 Recalling a setup, 3-205
 Recalling a waveform, 3-213
 recent setup file, D-2
 Record, acquisition, shared by all channels, 3-20
 Record Length, 3-19, 3-104, 3-169, Glossary-10
 defined, 3-34
 derivative math waveforms, 3-158
 integral math waveforms, 3-160
 Rectangular window, 3-178, 3-180, 3-183, 3-197
 Reference
 clock, 2-10, D-12
 color, 3-115
 Levels, 3-129
 Levels Method, 3-125
 memory, Glossary-10
 Setup, D-1
 Waveforms, D-1, Glossary-10
 Reference selection, D-12
 Reference-Level Calculation Methods, 3-126
 References, 3-123
 clear, 3-220
 clearing, 3-220
 delete, 3-220
 references, 3-124
 Related Manuals, xiv

Relative Reference, 3-125
Release Notes, for Plug & Play Software, 1-11
Remote communication, 3-243
Remove Measurements, 3-128
repetitive signal, 3-29
Reset all, D-7
reset histogram counting, 3-140
Reset Histograms, D-10
Reset statistics, D-9
Reset Zoom Factors, Zoom menu, 3-113
Resolution, 3-19, 3-169, D-5
Resolution Bandwidth, 3-172, 3-198
Restore Help, D-12
Rise Time, B-2, D-9, Glossary-10
Rising edge, A Trigger control window, 3-87, 3-89
RMS, B-2, D-9, Glossary-10
Roll Mode
 Auto, D-5
 Illustrated, 3-26
 Incompatible with Fast Acquisitions, 3-38
 Untriggered, 3-25
 Untriggered, with Single Sequence, 3-25
 Using, 3-31
Run Application, D-1
RUN/STOP, 3-28, 3-47
Run/Stop, D-5, D-6
Run/Stop Button Only, 3-25
Runt Setup, D-6
Runt trigger, 3-68, D-6, Glossary-10
 How to set up, 3-75-3-100
Runt, A Trigger control window, 3-75

S

S/N ratio, B-4, D-9
Sample, 3-22, 3-28
Sample acquisition mode, Glossary-10
Sample interval, 3-19, Glossary-10
 defined, 3-34
Sample Rate, Maximum, 3-38
Samples, number of, 3-24
Sampling, 3-35, Glossary-11
 modes, 3-33-3-35
 process, defined, 3-33-3-38
 process, illustrated, 3-33-3-38
Sampling and acquisition mode, 3-35
Save format, export, 3-223
Save waveform, D-1
Save Wfm, D-1
Saving a setup, 3-205
Saving a waveform, 3-213

Scale, 3-104
 horizontal, D-5
 vertical, 3-159, D-1, D-3
Scaling and Positioning, 3-6
Screen saver, 3-116, D-8
Screen text, 3-114, D-7, Glossary-11
Second monitor setup, 1-14
Select for Copy, D-3
Select for Export, D-2
Select Input Coupling, 3-9
Select Input Termination, 3-8
Select Polarity, 3-79
Select the Input Signal Channel, 3-8
Select Waveform Interpolation, 3-118
Selected waveform, Glossary-11
selecting zoom, 3-110
Sequential Triggering, 3-92
Serial number, D-12
Service support, contact information, xv
Set FFT Vert Scale, 3-195
Set Horizontal Acquisition Window, 3-10
SET LEVEL TO 50% button, 3-60
Set Math Averages, D-11
Set Thresholds, A Trigger control window, 3-84, 3-87
Set Time & Date, D-11
Set to 50%, Main Trigger menu, 3-60
Set to ECL, A Trigger control window, 3-80
Set to TTL, A Trigger control window, 3-80
Set Vertical Acquisition Window, 3-9
Set/Hold Trigger, 3-71
Setting, Glossary-11
Setting Acquisition Controls, 3-21
Setting vertical range and position, 3-16
Setup
 control window, Glossary-11
 dual display, 1-14
 file, D-2
 recalling, 3-205
 saving, 3-205
 second monitor, 1-14
Setup/Hold Setup, D-6
Setup/Hold trigger, 3-71, D-6
 How to set up, 3-88
 Maximum hold time (NOTE), 3-71
 Negative setup or hold times, 3-71
 Positive setup or hold times, 3-71
 Trigger point location, 3-71
Shutdown, D-2
Signal Connection and Conditioning, 3-4
SIGNAL OUTPUT, 2-9
Signal Path Compensation, 3-141-3-152

- Sin(x)/x, 3-118, D-7
- Sin(x)/x interpolation, 3-37, 3-117, Glossary-6
- SINGLE, 3-25, 3-28
- Single Sequence, 3-25
- Single Sequence OFF, 3-28
- SINGLE TRIG** button, 3-67
- Single Shot sampling, 3-35
- site considerations, 1-6
- Slew rate trigger, 3-69, Glossary-11
- 600 ps limitation, 3-81
 - 7.5 ns limitation, 3-81
 - How to set up, 3-79-3-100
- Slope, Glossary-11
- Slope, Trigger, 3-57
- Snapshot, D-9
- Snapshot of Measurements, 3-130
- Software Installation, 1-11-1-13
- Source**, A Trigger control window, 3-73, 3-75, 3-77, 3-79, 3-82
- Source**, B Trigger control window, 3-98
- sources, 3-123, 3-124
- Span, 3-171
- Specifications, A-1, D-12
- Spectral analysis, displaying phase, 3-196
- Spectral analyzer controls, 3-198
- Spectral Averaging, 3-168
- Spectral Controls, D-11
- Spectral grading, D-7, D-8
- Spectral Math
- 3 dB BW in bins, 3-180
 - acquisition mode, 3-190
 - Affects of frequency domain control adjustments, illustrated, 3-173
 - Affects of trigger jitter, 3-189
 - Aliasing, 3-190
 - averaging, 3-190
 - bandwidth, 3-198
 - Blackman-Harris, 3-178, 3-180, 3-185, 3-197
 - Center, 3-172
 - center frequency, 3-198, 3-200
 - Coefficients, 3-180, 3-181
 - Coherent gain, 3-180
 - dB, 3-174, 3-195
 - dBm, 3-174, 3-195
 - Defining Spectral Math Waveforms, 3-168
 - Definition of gate parameters, illustrated, 3-171
 - degree, 3-196
 - Display the Math Control Window, 3-192, 3-193
 - Display the Spectral Waveform, 3-194
 - duration, 3-169, 3-199
 - Duration and resolution control effects, illustrated, 3-170
 - Example of scallop loss for a Hanning Window without zero fill, illustration, 3-181
 - Example of the effects of setting the Phase Suppression Threshold, illustrated, 3-177
 - Flattop2 window, 3-178, 3-180, 3-187, 3-197
 - Frequency Domain Controls, 3-168
 - frequency domain span, 3-199
 - frequency range, 3-198
 - frequency span, 3-198
 - gate controls, 3-170
 - gate duration, 3-199
 - gate position, 3-199
 - Gating Controls, 3-168
 - Gaussian window, 3-178, 3-180, 3-182, 3-197
 - Group Delay, 3-177, 3-196
 - Hamming window, 3-178, 3-180, 3-184, 3-197
 - Hanning window, 3-178, 3-180, 3-185, 3-197
 - How aliased frequencies appear in a spectral waveform, illustrated, 3-191
 - Impulse Response Testing, 3-177
 - Kaiser-Bessel window, 3-178, 3-180, 3-185, 3-197
 - Linear, 3-174, 3-195
 - Magnitude Verses Frequency, 3-168
 - Multiple Analyzer Control Locks, 3-169
 - Nearest Side Lobe, 3-180, 3-181
 - phase reference point, 3-199
 - Phase Reference Position, 3-175
 - Phase Unwrap, 3-176
 - Phase Verses Frequency, 3-168
 - radian, 3-196
 - Real and Imaginary Magnitudes, 3-175
 - Recognizing Aliasing, 3-190
 - record length, 3-169, 3-199
 - Rectangular window, 3-178, 3-180, 3-183, 3-197
 - reducing noise, 3-196
 - Reference Level, 3-174
 - Reference Level Offset, 3-175
 - resolution, 3-169, 3-199
 - Resolution Bandwidth, 3-172, 3-198, 3-199
 - sample rate, 3-198, 3-199
 - scale factor, 3-195, 3-196
 - Scallop Loss, 3-180
 - Select a Predefined Spectral Analysis Math Waveform, 3-192
 - Select a Spectral Waveform, 3-193
 - Select Spectral Analysis Setup, 3-193
 - Select the Window Type, 3-197
 - Set the Frequency Domain Controls, 3-198
 - Set the Magnitude Scale, 3-195
 - Set the Phase Scale, 3-196
 - Set the Time Domain Controls, 3-199

- Set Time and Frequency Domain Control Tracking, 3-196
 - Span, 3-171
 - Spectral Analyzer controls, 3-169
 - Spectral Averaging, 3-168
 - Suppression Threshold, 3-176
 - Take Cursor Measurements, 3-200
 - Tek Exponential window, 3-178, 3-180, 3-189, 3-197
 - Tek Exponential window in the time and the frequency domains, illustration, 3-189
 - Time and frequency domain graphs for the Flattop2 window, illustration, 3-188
 - Time and frequency domain graphs for the Rectangular window, illustration, 3-183
 - Time and frequency graphs for the Gaussian window, illustration, 3-182
 - Time and frequency graphs for the Hanning Window, illustration, 3-185
 - Time and frequency graphs for the Kaiser-Bessel window, illustration, 3-186
 - Time and frequency graphs of the Blackman-Harris window, illustration, 3-187
 - Time and frequency graphs of the Hamming window, 3-184
 - Time Domain Controls, 3-168
 - To Define A Spectral Math Waveform, 3-193
 - To Select a Predefined Spectral Math Waveform, 3-192
 - To Take Automated Measurements of a Spectral Math Waveform, 3-191
 - To Take Cursor Measurements of a Spectral Math Waveform, 3-191
 - unwrap phase, 3-196
 - Using Spectral Math Controls, 3-169
 - Using the Frequency Domain controls, 3-171
 - Using the gate controls, 3-170
 - Using the magnitude controls, 3-174
 - Using the Phase controls, 3-175
 - Using the time controls, 3-169
 - Using windows to filter, 3-178
 - Window characteristics, 3-178, 3-180
 - Window Functions, 3-168
 - Windowing the Time Domain Record, illustrated, 3-179
 - Zero Phase Reference, 3-180, 3-181
 - Spectral math
 - FFT length, 3-179
 - phase unwrap
 - algorithm, 3-176
 - dejitter, 3-176
 - swept sine wave analysis, 3-191
 - Spectral math waveform
 - aliasing, 3-190
 - phase suppression, 3-176
 - undersampling, 3-190
 - zero phase reference, 3-181
 - Spectral Math Waveforms. *See* Spectral Math
 - Spectral Setup, D-11
 - Split, D-8
 - Split cursors, 3-132
 - Spreadsheet, file format, 3-223
 - Standard, accessories, 1-30
 - Standard Deviation, 3-128, D-10
 - start histogram counting, 3-140
 - startup disk, creating, 1-10
 - State trigger, 3-70, 3-87
 - How to set up, 3-87
 - State**, Main Trigger menu, 3-87, 3-88
 - Statistical measurement, Glossary-11
 - Statistics, D-9
 - statistics, 3-128
 - on measurement results, 3-123
 - Statistics controls, D-9
 - Status, calibration, 3-142
 - status, calibration, 3-147
 - StdDev, B-2
- ## T
- Technical Support, D-12
 - Technical support, contact information, xv
 - Tek Exponential window, 3-178, 3-180, 3-189
 - Tek Secure, 3-220, D-11, Glossary-11
 - Tektronix, contacting, xv
 - TekVISA, 2-2
 - Temperature compensation, 3-141-3-152
 - Temperature grading, D-7, D-8
 - Termination, D-4
 - Test Equipment, for Incoming Inspection Procedure, 1-17
 - Text
 - file format, 3-223
 - On screen, 3-114, D-7
 - Thresholds**, A Trigger control window, 3-76, 3-80
 - Time, D-9
 - get current, 3-242
 - Time base, Glossary-12
 - time cursor readout values, 3-134
 - Time Domain Controls, 3-168
 - timebase, 3-105
 - Timeout
 - A Trigger control window, 3-82
 - trigger, D-6

- Timeout trigger, 3-69, 3-82, Glossary-12
 - How to set up, 3-82
- Timer**, A Trigger control window, 3-82
- To Autoset the Oscilloscope, 3-11
- To Get More Help, 3-13
- To Reset the Oscilloscope, 3-12
- Touch Screen, 3-103, 3-106
- Trace, Glossary-12
- Trace expression, Glossary-12
- Track, D-8
- Transition
 - Setup, D-6
 - trigger, 3-69, D-6
- Trig Delay**, A Trigger control window, 3-96
- Trig Events**, A->B Seq Trigger control window, 3-97
- Trigger, 3-54, Glossary-12
 - A Only, 3-96
 - AC Line Voltage, 3-54, 3-60
 - Auxiliary, 3-54, 3-60
 - Coupling, 3-57
 - Delay, 3-58
 - Edge, 3-55, Glossary-4
 - Glitch, 3-68, 3-73, Glossary-4
 - Holdoff, 3-56
 - Level, 3-57, Glossary-12
 - Line, 3-54, 3-60
 - Logic, 3-68, 3-70
 - Marker, 3-115
 - Mode, 3-55
 - Pattern, 3-69, 3-84
 - Position, 3-57
 - Pulse, 3-68
 - Readout, 3-62
 - Runt, 3-68, 3-75, Glossary-10
 - Setup/Hold, 3-71, 3-88
 - Slew Rate, Glossary-11
 - Slew rate, 3-69
 - Slope, 3-57
 - Source, 3-54
 - State, 3-70, 3-87
 - Status Lights, 3-62
 - Timeout, 3-69, 3-82, Glossary-12
 - Transition, 3-69
 - Types, 3-59
 - Width, 3-69, 3-77
- Trigger after A, 3-96
- Trigger after events, 3-97
- Trigger after time, 3-96
 - How to set up, 3-96
- Trigger and Display, 3-7
- Trigger events, A->B Seq Trigger control window, 3-97
- Trigger level marker, 3-115
- Trigger **MAIN LEVEL** knob, 3-58, 3-59
- Trigger menu
 - A Event (Main) Trigger Setup, D-6
 - A->B Trigger Sequence, D-6
 - B Event (Delayed) Trigger Setup, D-6
 - comm, D-6
 - comm setup, D-6
 - Edge, D-6
 - Edge Setup, D-6
 - Glitch, D-6
 - Glitch Setup, D-6
 - Holdoff, D-6
 - Logic Pattern, D-6
 - Logic Pattern Setup, D-6
 - Logic State, D-6
 - Logic State Setup, D-6
 - Mode, D-6
 - Quick Select, D-6
 - Run/Stop, D-6
 - Runt, D-6
 - Runt Setup, D-6
 - Setup/Hold, D-6
 - Setup/Hold Setup, D-6
 - Timeout, D-6
 - Timeout Setup, D-6
 - Transition, D-6
 - Transition Setup, D-6
 - Width, D-6
 - Width Setup, D-6
- Trigger Overview, 3-53
- Trigger point, defined, 3-34
- Trigger setup, D-6
- Trigger Status Lights, 3-62
- Trigger T, 3-115, D-8
- Trigger When
 - A Trigger, 3-86
 - A Trigger control window, 3-88
- Trigger when
 - transition is <, A Trigger control window, 3-81
 - transition time >, A Trigger control window, 3-81
- Trigger When**, A Trigger control window, 3-85
- Trigger, delayed, How to set up, 3-96
- Trigger, glitch, How to set up, 3-73
- Trigger, runt, How to set up, 3-75-3-100
- Trigger, slew rate, How to set up, 3-79-3-100
- Trigger, timeout, How to set up, 3-82
- Trigger, width, How to set up, 3-77-3-100
- Triggering
 - advanced, 3-55
 - Advanced Triggering, 3-68
 - comm triggering, 3-55, 3-99
 - Define Inputs, 3-87
 - Define Logic, 3-87

- Define the Clock Source and Edge, 3-89
 - Define the Data Source, 3-89
 - Delayed Trigger System, 3-58
 - edge, 3-55
 - Glitch Trigger, 3-68
 - Horizontal Position, 3-57
 - logic trigger definitions, 3-70
 - overview of, 3-53
 - Pattern Trigger, 3-69
 - posttrigger, 3-54
 - pretrigger, 3-54
 - Runt Trigger, 3-68
 - Select Glitch Triggering, 3-73
 - Select Runt Triggering, 3-75
 - Select Setup/HOLD Triggering, 3-88
 - Select State Triggering, 3-87
 - Select the Polarity, 3-75, 3-77
 - Select the Polarity & Width, 3-73
 - Select the Source, 3-73, 3-75, 3-77, 3-79, 3-82
 - Select Timeout Triggering, 3-82
 - Select Transition Triggering, 3-79
 - Select Width Triggering, 3-77
 - Sequential Triggering, 3-92
 - Set the Data and Clock Levels, 3-89
 - Set the Level, 3-74, 3-78, 3-83
 - Set the Setup and Hold Times, 3-90
 - Set the Thresholds, 3-76
 - Set the Timer, 3-82
 - Set the Transition Time, 3-80
 - Set Thresholds, 3-87
 - Set to Trigger if Width, 3-74
 - Set to Trigger When, 3-76, 3-78, 3-81, 3-82
 - Set Trigger When, 3-88
 - Setup/Hold Trigger, 3-71
 - Slope and Level, 3-57
 - State Trigger, 3-70
 - The The Trigger Event, 3-54
 - Timeout Trigger, 3-69
 - To Check Trigger Status, 3-62
 - To Define a Time Qualified Pattern Trigger, 3-86
 - To Define New Trigger Level Presets, 3-66
 - To Define Pattern Inputs, 3-84
 - To Define the Logic, 3-85
 - To Force a Trigger, 3-66
 - To Select a Preset Trigger Level, 3-65
 - To Select the Trigger Mode, 3-61
 - To Select the Trigger Slope, 3-59
 - To Select the Trigger Source, 3-60
 - To Select the Trigger Type, 3-59
 - To Set Holdoff, 3-64
 - To Set Level, 3-59
 - To Set Mode and Holdoff, 3-74, 3-77, 3-78, 3-81, 3-83, 3-85, 3-88, 3-90
 - To Set the Trigger Coupling, 3-61
 - To Set Thresholds, 3-84
 - To Set to 50%, 3-60
 - To Set Trigger When, 3-85
 - To Set Up B Triggering, 3-98
 - To Single Trigger, 3-67
 - To Trigger Based on Transition Time, 3-79
 - To Trigger on A (Main) Only, 3-96
 - To Trigger on a Glitch, 3-73
 - To Trigger on a Pattern, 3-84
 - To Trigger on a Runt Pulse, 3-75
 - To Trigger on a State, 3-87
 - To Trigger on B After Time, 3-96
 - To Trigger on B Events, 3-97
 - To Trigger on Setup/Hold Time Violations, 3-88
 - Transition Trigger, 3-69
 - Trigger and Horizontal Delay Summary, 3-95
 - Trigger Based on Pulse Timeout, 3-82
 - Trigger Based on Pulse Width, 3-77
 - Trigger Coupling, 3-57
 - Trigger Holdoff, 3-56
 - Trigger Location and Level From Display, 3-63
 - Trigger Modes, 3-55
 - Trigger on a Pattern, 3-84
 - Trigger Sources, 3-54, 3-92
 - Trigger Status From Acquisition Readout, 3-62
 - Trigger Status From Trigger Status Lights, 3-62
 - Trigger Types, 3-55, 3-92
 - Triggering Concepts, 3-54
 - Triggering from the Front Panel, 3-58
 - Triggering with Horizontal Delay Off, 3-93
 - Triggering with Horizontal Delay On, 3-94
 - Using Sequential Triggering, 3-92
 - Width, 3-69
 - Triggering from the Front Panel, 3-58
 - True for less than**, Main Trigger menu, 3-86
 - True for more than**, Main Trigger menu, 3-86
 - TRUE**, A Trigger control window, 3-85, 3-88
 - TTL, 3-74, 3-80, 3-83, 3-89
 - A Trigger level, 3-65
 - TTL**, A Trigger level, 3-66
- ## U
- Undershoot, Glossary-8
 - Undo, autoset, D-5
 - Undo autoset, D-3
 - unpacking, 1-5
 - Update, Software, 1-3
 - Upgrade, firmware, 1-3
 - URL, Tektronix, xv
 - user files, backing up, 1-10

User palette, D-7, D-8
 User Preferences, D-12
USER, A Trigger level, 3-65, 3-66
 Using the Acquisition Controls, 3-22
 Using the Waveform Display, 3-102
 Utilities menu
 AUX Out configuration, D-12
 Deassign Multipurpose Knobs, D-12
 external signals, D-12
 GPIB Configuration, D-11
 Instrument Calibration, D-12
 Instrument Diagnostics, D-12
 Option Installation, D-12
 reference selection, D-12
 Set Time and Date, D-11
 Tek Secure, D-11
 User Preferences, D-12

V

Value Count, D-10
 Value mean, D-9
 Variable Persistence, 3-118, D-7
 Display control window, 3-116
Variable Persistence, Display control window, 3-116
 Varying vertical offset, 3-17
 V-bars, D-8
 Vectors, 3-114, 3-116, D-7
 Display control window, 3-116
 Vectors display, Incompatible with DPO, 3-38
 Verification, Incoming Inspection Procedure, 1-17
 Version number, D-12
 Vertical
 Acquisition Window Considerations, 3-14
 Bar cursors, Glossary-12
 control window, Deskew, 3-148
 cursors, 3-132, 3-134
 deskew, 3-148, Glossary-2
 Vertical menu
 Attenuation, D-4
 Bandwidth, D-4
 Coupling, D-4
 Deskew, D-4
 Display On/Off, D-3
 Label, D-3
 Offset, D-4
 Position/Scale, D-3
 Probe Cal, D-4
 Termination, D-4
 Vertical Setup, D-3
 Zoom Controls, D-3
 Zoom Setup, D-4

vertical offset, 3-104
 discussion on setting, 3-14
 vertical position, 3-104
 Vertical range, discussion on setting, 3-14
 vertical scale, 3-104
 Vertical scale and offset
 illustrated, 3-16
 uses for, 3-4
 Vertical set up, purpose, 3-4
 Vertical Setup, D-3
 Vertical window, overview, 3-13, 3-14
 View, printing, 3-239
 Virtual keyboard, control window, 3-205, 3-213
 Voltage
 overrange and underrange points, 3-14
 overview, 3-14

W

Waveform, D-2, D-3, Glossary-12
 Acquiring and Displaying of, 3-3
 copying, 3-223
 displaying, 3-101
 exporting, 3-223
 Interval, Glossary-12
 printing, 3-238
 recalling, 3-213
 save formats, 3-223
 saving, 3-213
 Waveform clipping. *See* Clipping
 Waveform Count, B-2
 Waveform database, 3-24, 3-28, 3-47, Glossary-12
 Waveform differentiation, 3-157
 Waveform Display, 3-103
 Waveform FFTs, 3-168
 Waveform Histograms, D-10
 Waveform integration, 3-159
 Waveform intensity, 3-115
Waveform Intensity, Display menu, 3-44
 Waveform interpolation, 3-115, D-7
 Waveform record, 3-34
 definition applied to all channels, 3-20
 illustrated, 3-34, 3-134
 spectral source, long versus short, 3-169
 Waveforms
 and zoom, 3-109
 clear, 3-220
 delete, 3-220
 Measuring, 3-121
 Web site address, Tektronix, xv
 WfmDB, Glossary-12

Width, Glossary-8, Glossary-9
 A Trigger control window, 3-77
 Main Trigger menu, 3-73, 3-76
 Setup, D-6
 trigger, D-6
Width trigger, 3-69, 3-77
 How to set up, 3-77-3-100
Window, 3-178
 Blackman-Harris, 3-197
 characteristics of, 3-178
 Flattop2, 3-197
 Gaussian, 3-197
 Hamming, 3-197
 Hanning, 3-197
 Kaiser-Bessel, 3-197
 rectangular, 3-197
 rectangular vs. bell-shaped, 3-183
 selecting, 3-179
 Tek Exponential, 3-197
Window characteristics, 3-180
Window Functions, 3-168
Windows, descriptions of, 3-197

X

XY, D-7
 format, 3-45, Glossary-12
XYZ, D-7
 format, 3-45, Glossary-13

Y

YT, D-7
 format, 3-45, Glossary-13

Z

Zero phase reference point, 3-181
 establishing for impulse testing, 3-181
Zoom, 3-103, 3-104, 3-109-3-120, 3-131
 100%, D-4, D-5
 50/50%, D-4, D-5
 80/20%, D-4, D-5
 a Waveform, 3-111
 and waveforms, 3-109
 button, 3-110
 Controls, D-3, D-4
 display area, D-5
 feature, 3-109
 Graticule, D-5
 Incompatible with Fast Acquisitions, 3-38
 lock, D-5
 lock all, D-5
 lock live, D-5
 lock none, D-5
 Setup, D-4, D-5
Zoom graticule, D-4
Zoom menu, **Reset Zoom Factors**, 3-113
Zoom Setup control window, 3-105

