



ABN 43 064 478 842

231 Osborne Avenue Clayton South, VIC 3169
PO Box 1548, Clayton South, VIC 3169
t 03 9265 7400 f 03 9558 0875
freecall 1800 680 680
www.tmgtestequipment.com.au

Test & Measurement

- > sales
- > rentals
- > calibration
- > repair
- > disposal

Complimentary Reference Material

This PDF has been made available as a complimentary service for you to assist in evaluating this model for your testing requirements.

TMG offers a wide range of test equipment solutions, from renting short to long term, buying refurbished and purchasing new. Financing options, such as Financial Rental, and Leasing are also available on application.

TMG will assist if you are unsure whether this model will suit your requirements.

Call TMG if you need to organise repair and/or calibrate your unit.

If you click on the "Click-to-Call" logo below, you can call us for FREE!

TMG Corporate Website

TMG Products Website



Click-to-Call
TMG Now



Product Lifecycle Management System

Disclaimer:

All trademarks appearing within this PDF are trademarks of their respective owners.



User Manual



NetTek™ Analyzer OTDR Modules 071-1213-02

This document supports software version 3.00
and above.

www.tektronix.com

Copyright © Tektronix, Inc. All rights reserved.

Tektronix products are covered by U.S. and foreign patents, issued and pending. Information in this publication supercedes that in all previously published material. Specifications and price change privileges reserved.

Tektronix, Inc., P.O. Box 500, Beaverton, OR 97077

TEKTRONIX, TEK, NETTEK, TARGET1, and INTELLITRACE PLUS are registered trademarks of Tektronix, Inc.

WARRANTY

Tektronix warrants that the products that it manufactures and sells will be free from defects in materials and workmanship for a period of one (1) year from the date of purchase from an authorized Tektronix distributor. If any such product proves defective during this warranty period, Tektronix, at its option, either will repair the defective product without charge for parts and labor, or will provide a replacement in exchange for the defective product. Batteries are excluded from this warranty.

In order to obtain service under this warranty, Customer must notify Tektronix of the defect before the expiration of the warranty period and make suitable arrangements for the performance of service. Customer shall be responsible for packaging and shipping the defective product to the service center designated by Tektronix, shipping charges prepaid, and with a copy of customer proof of purchase. Tektronix shall pay for the return of the product to Customer if the shipment is to a location within the country in which the Tektronix service center is located. Customer shall be responsible for paying all shipping charges, duties, taxes, and any other charges for products returned to any other locations.

This warranty shall not apply to any defect, failure or damage caused by improper use or improper or inadequate maintenance and care. Tektronix shall not be obligated to furnish service under this warranty a) to repair damage resulting from attempts by personnel other than Tektronix representatives to install, repair or service the product; b) to repair damage resulting from improper use or connection to incompatible equipment; c) to repair any damage or malfunction caused by the use of non-Tektronix supplies; or d) to service a product that has been modified or integrated with other products when the effect of such modification or integration increases the time or difficulty of servicing the product.

THIS WARRANTY IS GIVEN BY TEKTRONIX WITH RESPECT TO THE LISTED PRODUCTS IN LIEU OF ANY OTHER WARRANTIES, EXPRESS OR IMPLIED. TEKTRONIX AND ITS VENDORS DISCLAIM ANY IMPLIED WARRANTIES OF MERCHANTABILITY OR FITNESS FOR A PARTICULAR PURPOSE. TEKTRONIX' RESPONSIBILITY TO REPAIR OR REPLACE DEFECTIVE PRODUCTS IS THE SOLE AND EXCLUSIVE REMEDY PROVIDED TO THE CUSTOMER FOR BREACH OF THIS WARRANTY. TEKTRONIX AND ITS VENDORS WILL NOT BE LIABLE FOR ANY INDIRECT, SPECIAL, INCIDENTAL, OR CONSEQUENTIAL DAMAGES IRRESPECTIVE OF WHETHER TEKTRONIX OR THE VENDOR HAS ADVANCE NOTICE OF THE POSSIBILITY OF SUCH DAMAGES.



Table of Contents

General Safety Summary	ix
Preface	xi
Software Version	xi
Related Products	xii
Conventions	xii
About this Manual	xii
Related Documentation	xiii
Contacting Tektronix	xiv

Getting Started

Product Description	1-1
Installing an Instrument Module	1-2
Removing an Instrument Module	1-6
Using the Laser Optical Port and Connector Adapter	1-7
Install the Appropriate Connector Adapter	1-9
Remove a Connector Adapter	1-10

Operating Basics

Using the Online Help	2-1
Elements of the Main Screen	2-3
Main Screen Buttons	2-3
Viewing the Trace and Table	2-5
Changing the Proportions of the Trace and Table Regions .	2-5
Setting Trace Display Options	2-6
Zooming	2-7
Cursors	2-11
Event Table Columns	2-12
Tutorial	2-15
Take a Basic Measurement	2-15
Analyze the Results	2-16

Examine the Trace Data	2-16
Find the Length of the Fiber	2-18
Examine the Two-Point Loss	2-18
Examine an Event	2-19
Examine the Event Table Data	2-19
Configuring the Settings and Saving and Opening Files ...	2-21
Configuring Settings	2-21
Settings that Affect How Data is Collected	2-24
Settings that Affect How Data is Displayed	2-26
Copying Settings to Other Tabs	2-28
Saving Tests and Settings	2-29
Save a Test	2-29
Save Settings Only	2-31
Opening Trace or Setting and Limit Files	2-33
Opening a Trace File	2-33
Opening a Settings Only File	2-34
Determine Which Settings Were Used for a Trace	2-36
Examine the Test1.SOR, Test2.SOR, and Test-MM.SOR	
Files	2-37

Reference

Taking Measurements	3-1
Performing Event Loss Measurements	3-2
Event Loss Advanced Controls	3-3
Performing Two Point Measurements	3-4
Two Point Loss Advanced Controls	3-5
Performing Reflectance Measurements	3-6
Reflectance Advanced Controls	3-6
Performing ORL Measurements	3-7
Compare Two Traces	3-8
Bidirectional Average Measurements	3-8
Difference Measurements	3-8
Dual Trace Mode	3-8
Performing Bidirectional Averages Measurement	3-9
Performing Difference Measurements	3-11
Auto Test and Save Dialog Box	3-12
Auto Sequence Wavelength Choices Dialog Box	3-13

Other Features	3-15
Increasing the Range	3-16
Finding the End When Grouped Events are Marked as “End” .	3-17
Getting the Best Resolution on Multimode Tests	3-18
Printing	3-19
Using with a Keyboard	3-20
Joining Cursors	3-21
Setting the Front Panel Loss Warning	3-21
Setting the Distance Units	3-21
Setting Factory Defaults	3-21
About File Types	3-22
SOR Format	3-22
CFF Format	3-22
SET Format	3-22
WFM Format	3-22
Making Notes on Events, Landmarks, and Fibers	3-23
Event / Landmark Notes Dialog Box	3-23
Fiber Notes Dialog Box	3-25
Adding, Moving, and Deleting, Events or Landmarks	3-26
Adding Events	3-26
Moving Events	3-27
Adding Landmarks	3-28
Moving Landmarks	3-29
Deleting Events	3-29
Deleting Landmarks	3-30
Deleting All Landmarks	3-30
Freezing Events	3-30

Appendices

Appendix A: Specifications	A-1
Appendix B: User-replaceable Parts, Options, and Accessories	B-1
Appendix C: Maintenance	C-1
Cleaning	C-1
Cleaning the Optical Port	C-2
Cleaning the Connector Adapter	C-2
Cleaning the Test Fiber Connector	C-3
Cleaning the Exterior of the Module	C-3
Transporting the OTDR	C-4

Repackaging for Shipment C-5
Appendix D: Installing an OTDR Software Upgrade D-1

Glossary

Index

Figures

Figure 1-1: Removing the bus door	1-3
Figure 1-2: Install instrument module	1-4
Figure 1-3: Laser optical connector	1-8
Figure 1-4: Connector adapter installation	1-9
Figure 2-1: Main screen	2-3
Figure 2-2: Zoomed out trace	2-7
Figure 2-3: Zoomed in trace, with overview window showing whole trace	2-8
Figure 2-4: Event Table Only view	2-12
Figure 2-5: A Run tab of the Test Settings and Limits dialog box	2-22
Figure 2-6: A Trace tab (labeled with the file name) of the Test Settings and Limits dialog box	2-23
Figure 2-7: Sample file Test1.SOR illustrates that different types of events can look similar	2-38
Figure 2-8: Compare the amounts of loss and reflectance in each of the events in the sample file Test1.SOR	2-39
Figure 2-9: Event 2 is an FC regular connector	2-40
Figure 2-10: Event 3 is a fusion splice	2-41
Figure 2-11: Event 4 is a mechanical splice	2-42
Figure 2-12: Event 5 is a bend	2-43
Figure 2-13: Event 6 is a fusion splice	2-44
Figure 2-14: Event 7 is the end of the fiber	2-45
Figure 2-15: Sample file test2.SOR shows a worn angle-polished connector (Event 5) and several fusion splices	2-46
Figure 2-16: Sample file Test-MM.SOR shows several types of events on a multimode fiber	2-47

Figure 2-17: Look at the event notes in the event table of sample file Test-MM.SOR	2-48
Figure 2-18: Event 1 (the front panel) and Event 2 (a jumper cable) are grouped due to the short distance between them	2-49
Figure 2-19: Events 3 and 4 are echoes of 1 and 2 and are grouped with each other	2-50
Figure 2-20: Event 5 (high loss) and Event 6 (low loss) are both patch panel connectors	2-51
Figure 2-21: Event 7 is a good (low loss) fusion splice	2-52
Figure 2-22: Event 8 (the start of a pigtail), Event 9 (a patch panel connector), and Event 10 (the end of the fiber) ..	2-53
Figure 3-1: Event Loss for Event 2	3-2
Figure 3-2: Bidirectional Averages traces	3-9

Tables

Table i: NetTek Analyzer OTDR Modules	xi
Table 2-1: Help window buttons	2-2
Table 2-2: Main screen buttons	2-4
Table 2-3: Event Table column definitions	2-13
Table 2-4: Event Table symbols and highlights	2-14
Table 2-5: Choosing the Test Mode	2-25
Table 3-1: Sample event table with grouped end events ...	3-17
Table A-1: NetTek Analyzer OTDR Module characteristics	A-1
Table A-2: General characteristics	A-2
Table A-3: Transportation and storage	A-4
Table A-4: Environmental characteristics	A-5
Table A-5: Physical characteristics	A-7
Table A-6: Miscellaneous characteristics	A-7
Table A-7: Certifications and compliances	A-8
Table A-8: Safety compliance	A-9
Table B-1: User-replaceable parts	B-1
Table B-2: Connector options	B-1
Table B-3: Optional accessories	B-2
Table B-4: Standard accessories	B-2

General Safety Summary

Review the following safety precautions to avoid injury and prevent damage to this product or any products connected to it. To avoid potential hazards, use this product only as specified.

Only qualified personnel should perform service procedures.

While using this product, you may need to access other parts of the system. Read the *General Safety Summary* in other system manuals for warnings and cautions related to operating the system.

To Avoid Fire or Personal Injury

Observe All Terminal Ratings. To avoid fire or shock hazard, observe all ratings and markings on the product. Consult the product manual for further ratings information before making connections to the product.

The common terminal is at ground potential. Do not connect the common terminal to elevated voltages.

Do Not Operate Without Covers. Do not operate this product with covers or panels removed.

Avoid Exposed Circuitry. Do not touch exposed connections and components when power is present.

Wear Eye Protection. Wear eye protection if exposure to high-intensity rays or laser radiation exists.

Do Not Operate With Suspected Failures. If you suspect there is damage to this product, have it inspected by qualified service personnel.

Do Not Operate in Wet/Damp Conditions.

Do Not Operate in an Explosive Atmosphere.

Keep Product Surfaces Clean and Dry.

Provide Proper Ventilation. Refer to the manual's installation instructions for details on installing the product so it has proper ventilation.

Safety Terms and Symbols

Terms in This Manual. These terms may appear in this manual:



WARNING. *Warning statements identify conditions or practices that could result in injury or loss of life.*



CAUTION. *Caution statements identify conditions or practices that could result in damage to this product or other property.*

Terms on the Product. These terms may appear on the product:

DANGER indicates an injury hazard immediately accessible as you read the marking.

WARNING indicates an injury hazard not immediately accessible as you read the marking.

CAUTION indicates a hazard to property including the product.

Symbols on the Product. These symbols may appear on the product:



CAUTION
Refer to Manual



Double
Insulated



Protective Ground
(Earth) Terminal



Laser Aperture



Static Sensitive

Preface

This manual contains operating instructions for several Tektronix NetTek Analyzer OTDR modules. See Table i.

Table i: NetTek Analyzer OTDR Modules

Module	Fiber type	Range	Wavelengths
YSS1310	Singlemode	Standard	1310 nm
YSS1315	Singlemode	Standard	1310 nm / 1550 nm
YSL1315	Singlemode	Long	1310 nm / 1550 nm
YSL1625	Singlemode	Long	1625 nm
YSL1516	Singlemode	Long	1550 nm / 1625 nm
YSU1315	Singlemode	Ultra long	1310 nm / 1550 nm
YSU1625	Singlemode	Ultra long	1625 nm
YM8513	Multimode	Short	850 nm / 1300 nm

Software Version

This manual supports firmware version 3.0 and above of the NetTek Analyzer OTDR.

To verify your software and firmware versions, do the following:

1. Open the OTDR application.
2. Select **Help > About OTDR....**

Related Products

The Y350C NetTek Analyzer Platform supports the NetTek Series of OTDR and base station instrument module test tools that you can add or remove from the analyzer platform.

The NetTek analyzer platform accepts up to four modules at once, plus a PCMCIA module. You can mix and match modules to suit your needs. The platform is a full capability hand-held PC, running Windows CE.

Conventions

This book uses the following convention to represent menus:

To open the help window and find information on a specific topic, you would be instructed to select **Start > Help**. To accomplish this, tap **Start** in the toolbar at the bottom of the desktop window; then tap **Help** in the resulting WindowsCE menu.

Words in italics, such as *event loss*, indicate a glossary term.

About this Manual

Refer to this documentation for information such as the following:

- Module installation instructions
- Location of the laser on the OTDR
- Overview of screen features
- Tutorial for basic measurement and analysis tasks
- Measurement descriptions
- OTDR specifications, options and accessories, and user maintenance information
- OTDR terminology

Related Documentation

For general help and content sensitive help for the OTDR, refer to the OTDR online help.

- *NetTek Analyzer OTDR Online Help*
(In the OTDR application, select **Help > Help Topics...** or tap the ? button in a dialog box.)

The OTDR module attaches to and runs on the Y350C NetTek Analyzer platforms. For platform information, refer to the following resources:

- *Y350C NetTek Analyzer Platform User Manual*
- *Y350C NetTek Analyzer Platform Online Help*
(Select **Start > Help** or tap the ? button in a dialog box.)
- *Windows CE Operating System Online Help*
(Select **Start > Help** or tap the ? button in a dialog box.)

Refer to the platform resources listed above for information about the following topics:

- Battery and AC power, Battery care
- Platform power on and functional check
- Touch-screen calibration
- Platform operating instructions and menu descriptions
- Memory resources, floppy disk storage, PCMCIA interface
- Remote PC connection
- Instructions for upgrading platform software and changing the language
- Platform technical specifications
- Platform accessories, maintenance, diagnostics

Contacting Tektronix

Phone	1-800-833-9200*
Address	Tektronix, Inc. Department or name (if known) 14200 SW Karl Braun Drive P.O. Box 500 Beaverton, OR 97077 USA
Web site	www.tektronix.com
Sales support	1-800-833-9200, select option 1*
Service support	1-800-833-9200, select option 2*
Technical support	Email: techsupport@tektronix.com 1-800-833-9200, select option 3* 6:00 a.m. - 5:00 p.m. Pacific time

* **This phone number is toll free in North America. After office hours, please leave a voice mail message. Outside North America, contact a Tektronix sales office or distributor; see the Tektronix web site for a list of offices.**



Getting Started

Getting Started

Before using the NetTek Analyzer Platform for the first time, refer to the platform user manual for information on getting started, including the following:

- Battery and power source information. (You must charge the batteries before you can operate the NetTek Analyzer Platform from internal battery power.)
- Calibrating the touch screen.
- Installing the tilt stand, shoulder strap, or strand hook.

Product Description

An optical time domain reflectometer (OTDR) measures and locates fiber characteristics by transmitting light pulses into a fiber and measuring the elapsed time and the amplitude of the received reflection. The OTDR measures the distance to an event by measuring the amount of time required to receive the reflection.

With this OTDR, you can:

- Document and verify installations of new fibers in a network.
- Locate faults in the fiber.
- Check bandwidth upgrade capability by measuring the return loss and end-to-end loss in the network.
- Perform general preventive maintenance.

The NetTek Analyzer OTDR, with its easy-to-use interface, gives you good results with minimal training. The IntelliTrace Plus test mode automatically optimizes test parameters so you don't have to. It gives you the best resolution on every section of the fiber while maximizing dynamic range. The NetTek Analyzer OTDR provides an IntelliTrace Plus multi-pulsewidth, single-result auto test function to significantly reduce dead zone effects on your tests. You can see close events, including the first connector, at the same time you see events 200 km away. Advanced wave-shape analysis software finds more events than other OTDRs can locate. All these features combine to give you more information on your cables, with precise accuracy.

Installing an Instrument Module

Use the following procedure to install an instrument module onto the rear of the NetTek Analyzer Platform or to attach one module onto another. Refer to Figure 1-2 throughout this procedure.



CAUTION. *The platform and modules contain static sensitive devices. Do not touch the connector pins.*

1. Power off the NetTek Analyzer Platform: select **Start > Shutdown**.
2. Disconnect all cables to the NetTek Analyzer Platform and instrument modules.

3. Place the NetTek Analyzer face down on a flat surface. Support the analyzer by its four corner bumpers only.
4. Remove the bus door from the rear of the NetTek Analyzer Platform or instrument module. See Figure 1-1 or 1-2.

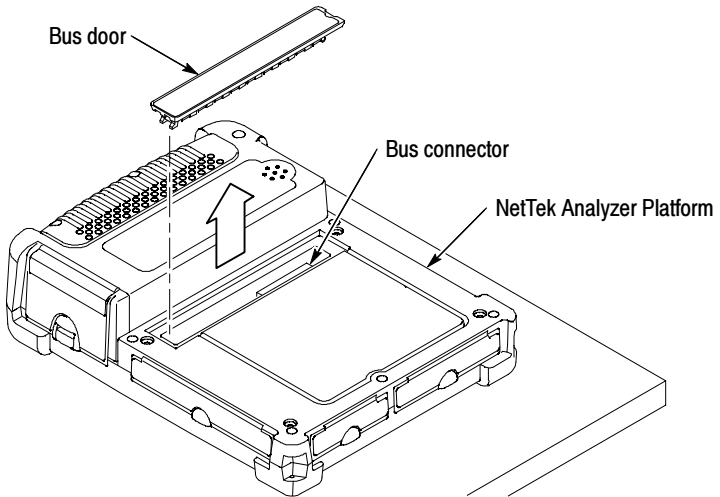

Figure 1-1: Removing the bus door

5. Carefully lower an Instrument module onto the NetTek Analyzer Platform or previously installed module to engage the bus connector. See Figure 1-2.

- 6. Press down firmly to seat the connector and ensure electrical contact.
- 7. Locate the four thumb screws. See Figure 1-2.

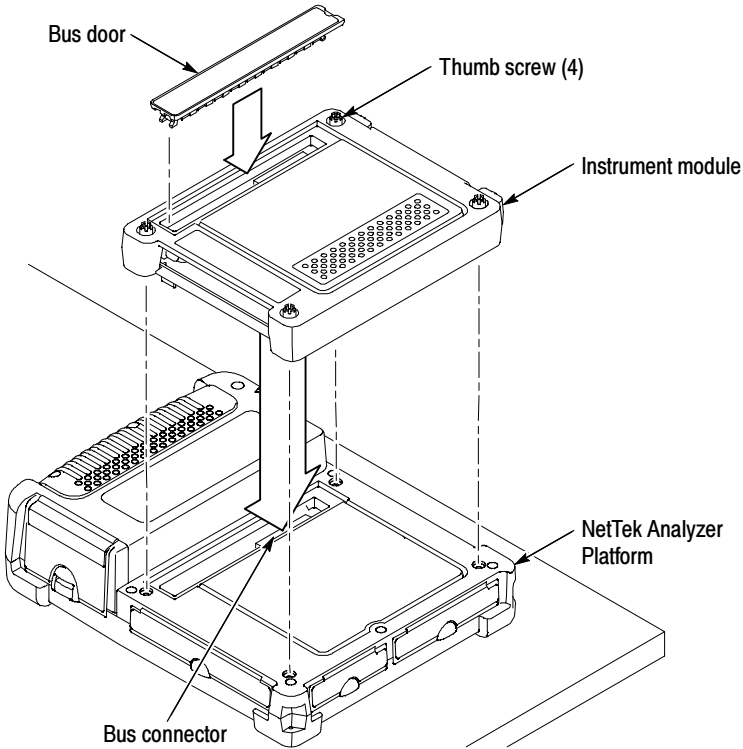

Figure 1-2: Install instrument module

- 8.** For each thumb screw, push down on the head and turn it in a counter-clockwise direction to extend the length.
- 9.** Tighten the screws by turning them in a clockwise direction. Use the coin slot in the top of the thumb screw if you require additional torque. Be sure to tighten all screws evenly.
- 10.** To recess the thumb screw heads, push and turn each screw head in a clockwise direction.
- 11.** To maintain the enclosure seal integrity, reinstall the bus door into the rear of the instrument module.

Removing an Instrument Module

Use the following procedure to remove an instrument module from the rear of the NetTek Analyzer Platform or to detach one module from another. Refer to Figure 1-2 throughout this procedure.



CAUTION. *The platform and modules contain static sensitive devices. Do not touch the connector pins.*

1. Power off the NetTek Analyzer Platform: select **Start > Shutdown**.
2. Disconnect all cables from the NetTek Analyzer Platform and instrument modules.
3. Place the NetTek Analyzer face down on a flat, uncluttered surface. Support the analyzer by its four corner bumpers only.
4. To release the thumb-screw heads, push and turn each screw head in a counter-clockwise direction.
5. Disengage all four screws by turning them in a counter-clockwise direction. A tool or coin may be required if the screws are tight.
6. Pull up on the instrument module to remove it.
7. To maintain enclosure seal integrity, reinstall the bus door into the NetTek Analyzer Platform or instrument module.

Using the Laser Optical Port and Connector Adapter



WARNING. *The light emitted by the laser source is invisible to the human eye. Do not stare directly into the laser source. Doing so while the laser is on can damage your eye.*

Do not stare at the free end of a test fiber (the end not connected to the instrument). If possible, direct the free end toward a non-reflective surface.



CAUTION. *Do not touch the exposed end of the laser output port with anything but the proper cleaning materials. To maintain the performance of fiber optic connectors, clean them every time you use them. Refer to Cleaning beginning on page C-1.*

To protect against dust and damage, cover the optical port when not in use.

The OTDR tests optical fibers by emitting short pulses of laser light. Figure 1-3 shows the location of the OTDR optical port. The optical port snaps out to a 45° angle. To return the optical port to the closed position, lift the release lever.

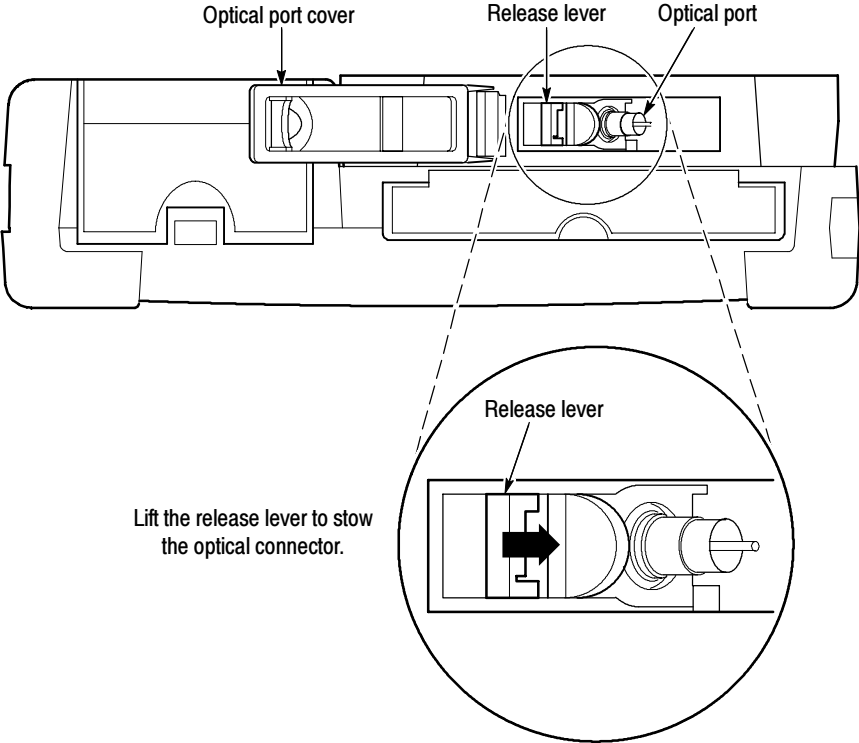

Figure 1-3: Laser optical connector

Install the Appropriate Connector Adapter



CAUTION. To avoid damage to the instrument, never connect a bare fiber adapter directly to the instrument.

The connector adapter attaches the fiber to the laser optical port. Connector adapters are packaged separately with new instruments, and must be installed on the laser optical port before use.

The connector adapter on the OTDR must match the connector on the test fiber. See page B-1 for a list of connector adapter options.

Connector adapters are keyed for proper mating with the laser output port.

To install a connector adapter, align the keyed elements, slide the connector adapter onto the laser output port, and turn clockwise until the connector adapter is finger tight (see Figure 1-4).

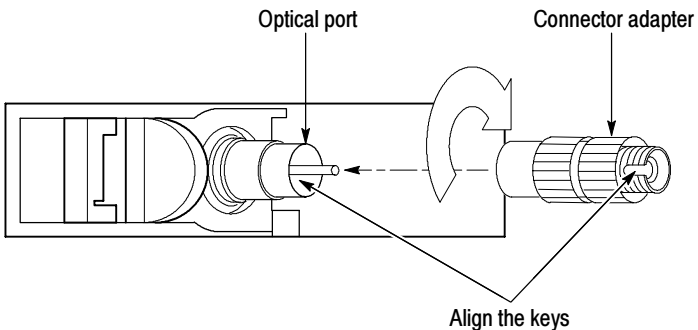

Figure 1-4: Connector adapter installation

Remove a Connector Adapter

To remove a connector adapter, unscrew it counterclockwise and pull it straight off the port. Refer to Figure 1-4 on page 1-9.



Operating Basics

Operating Basics

Read this section to understand the online help system and the main screen features.

Using the Online Help

Refer to the online help for information on operating the NetTek Analyzer and the OTDR. You will find both general help topics and context-sensitive help topics.

There are several ways to access online help:

- For platform information, select **Windows CE Start > Help**.
- For OTDR help, select **Windows CE Start > Help > OTDR**.
- For OTDR help when the OTDR program is open, you can also select **Help** from the upper right corner of the screen.
- For context-sensitive OTDR help when the OTDR program is open, select the **?** button in any dialog box.

To read a long help topic without having to scroll, select the  button to increase the size of the help window to full screen size.

To access related help topics, tap blue, underlined text.











If the Input Panel covers the help window, tap the  button at the bottom of the screen to close the Input Panel. Tap the button again to open the Input Panel.

Table 2-1: Help window buttons

Tap this button	To
 All Topics	Display the NetTek Analyzer main table of contents.
 Back	Return to the previous help screen.
 Contents	Display the current program or local table of contents.
	Display full-screen help text.
	Display the help text in its own window. Tap and drag the Help window title bar to move the window.
	Minimize the Help window. To maximize the window, tap the Help icon in the taskbar.
	Close the Help window and quit help.
	Scroll the text towards the bottom of the screen.
	Scroll the text towards the top of the screen.
	Open and close the soft keypad Input Panel. The button is located in the lower right hand corner of the touch screen. (Tap this button to uncover the Help.)

Elements of the Main Screen

The features you need most often are available on the main screen.

Main Screen Buttons

The main screen buttons represent the tasks that you need to perform most often. Many of these buttons duplicate operations that are available in the main menus. Refer to Figure 2-1 for the layout of the main screen; Table 2-2 lists the function of each button.

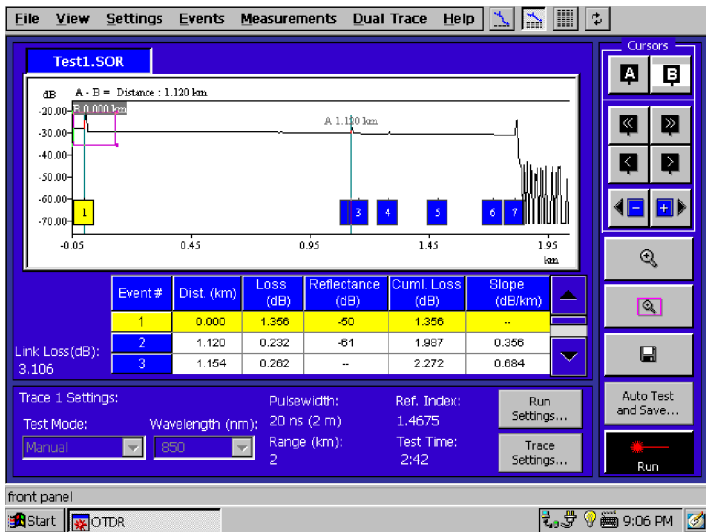

Figure 2-1: Main screen

Table 2-2: Main screen buttons













	<p>Change the display proportions. See <i>Changing the Proportions of the Trace and Table Regions</i> on page 2-5.</p>
	<p>Refresh the screen. Use this button if a screen element or the trace disappears. Use this button to center the trace around the active cursor when zoomed in.</p>
	<p>Toggle the active cursor. (Cursor A is active in this picture.)</p>
	<p>Move the active cursor left or right along the trace in large increments.</p>
	<p>Move the active cursor left or right along the trace in small increments.</p>
	<p>Jump the active cursor one event to the left or right.</p>
	<p>Control zooming. See <i>Zooming</i> on page 2-7.</p>
	<p>Save changes to the file. See <i>Saving Tests and Settings</i> on page 2-29.</p>
	<p>Open a dialog box, allowing you to automate taking and saving numerous, similar tests. See <i>Auto Test and Save Dialog Box</i> on page 3-12.</p>
	<p>Start an acquisition.</p>
	<p>Open a dialog box, allowing you to set up measurement thresholds and to flag out-of-limit data for the next trace you acquire. See <i>Configuring Settings</i> on page 2-21.</p>

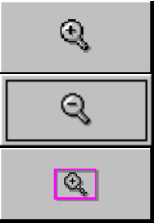

Table 2-2: Main screen buttons (Cont.)

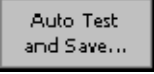
	<p>Open a dialog box, allowing you to set up measurement thresholds and to flag out-of-limit data for the active trace. See <i>Configuring Settings</i> on page 2-21.</p>
	<p>Open and close the soft keypad Input Panel, allowing you to enter alphanumeric characters with the touch screen. (This button is located in the lower right corner of the touch screen.)</p>

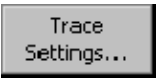
Viewing the Trace and Table

There are several ways that you can change the appearance of the main screen to best see your data.

Changing the Proportions of the Trace and Table Regions

You can change the proportions of the trace and table regions using the icons in the upper right corner of the screen:   .

You can also use the View menu:

- Select **View > Maximize Trace** to show the trace and only one row of event table data.
- Select **View > Split Trace and Table** to show the trace and three rows of event table data.
- Select **View > Event Table Only** to hide the trace and show only the event table.

Additionally, you can select **View > Display Settings** to hide or show key settings at the bottom of the main screen. Hide the settings to increase the size of the trace and to see more rows of the event table.

Setting Trace Display Options

Select **View > Trace Display Options**.

In this dialog box, you can change the appearance of the trace region of the main screen:

- Select or clear Event Markers to show or hide the  markings.
- Select or clear Delta Readouts to show or hide the readouts that appear along the top of the trace region.
- Select or clear Grid to show or hide grid lines on the trace region.

Zooming

Whenever the trace is visible, as in Figure 2-2, you can zoom in to take a closer look at an area of interest. The pink zoom box shows the area of the trace that will be zoomed in on. The zoom box will follow the active cursor.

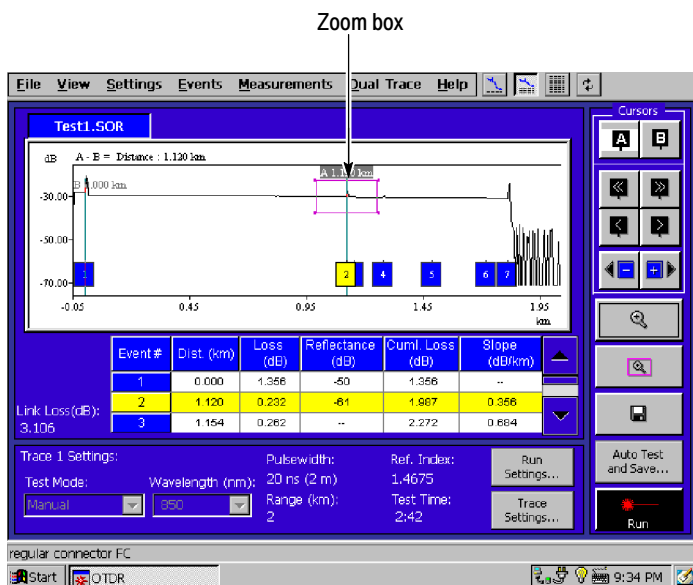



Figure 2-2: Zoomed out trace

When you zoom in, the upper right corner of the screen displays an overview window showing the whole trace. As shown in Figure 2-3, the zoom box in the overview window indicates the part of the trace that you zoomed in on.

You can show or hide the overview window by selecting **View > Display Overview Window**.

To zoom:

1. Move a cursor to the point of interest on the trace.
2. Drag the corners of the zoom box to adjust its size and shape.
3. Tap  to zoom in.
4. Tap  to zoom out when you want to look at the whole trace again.

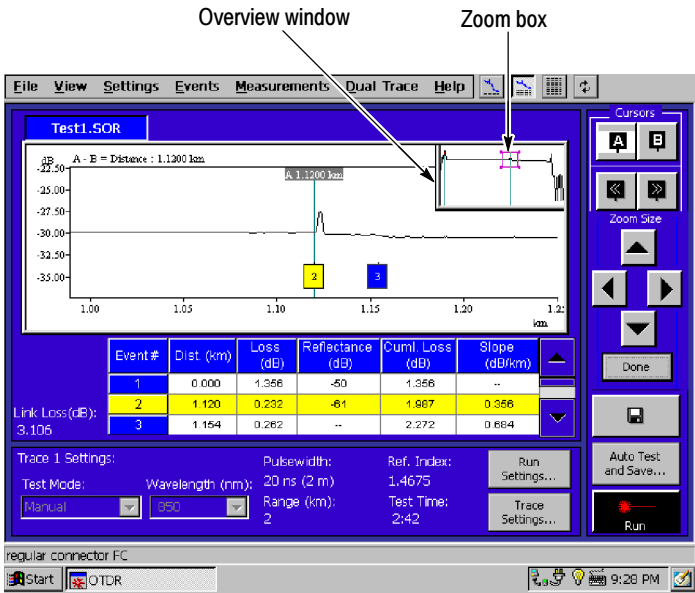

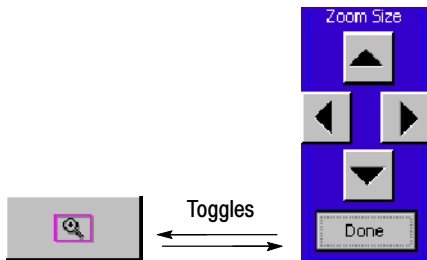





Figure 2-3: Zoomed in trace, with overview window showing whole trace

Sizing the Zoom Box with the Zoom Buttons. By changing the size of the zoom box, you can control the amount that you magnify the view of the trace, or you can change the scale of each axis independently.

To change the size of the pink zoom box:

- Drag the corners of the zoom box to adjust its size and shape.
- Tap the  button, and then use the arrow buttons:



-  increases the height of the pink zoom box.
-  decreases the height of the pink zoom box.
-  increases the width of the pink zoom box.
-  decreases the width of the pink zoom box.



To better see the power loss or reflectance of an event, change the vertical scale by tapping the  arrow several times.

If the zoom box disappears, select **View > Restore Zoom Box** to bring it back.









Moving the Zoomed View. When you are zoomed in, you can change the part of the trace that you see by:

- Moving the active cursor. For example, tap one of the Cursor buttons.
- Tapping the refresh button centers the view around the intersection of the active cursor and the trace.
- Moving the zoom box with scroll bars. Select **View > Zoom Scroll Bars** to show or hide the scroll bars. Use the scroll bars to move the pink zoom box in the overview window.

Cursors

There are two cursors. Tap the   buttons to toggle the active cursor. The active cursor appears in the center of the pink zoom box.

Try these ways to move the cursors:

- Touch and drag either cursor to move it along the trace.
- Tap the   buttons to jump the active cursor one event to the left or to the right.
- Use the   buttons to move the active cursor left or right along the trace in large increments.
- Use the   buttons to move the active cursor left or right along the trace in small increments.
- Tap the event marker, , in the trace area.
- Tap the event row, , in the event table.
- Double-tap a location in the trace area.

Event Table Columns

In Split Trace and Event Table view, you can see six columns of data in the event table. In Event Table Only view, you can also see Loss Δ , Dist. Δ , and Event Notes (if you scroll to the right). For landmarks, data will only appear in the Event#, Dist., and Notes columns.

Figure 2-4 below shows data in the Event Table Only view. Refer to Table 2-3 on page 2-13 for descriptions of the data in each event table column and Table 2-4 on page 2-14 for the meanings of marks, symbols, and highlights that appear in the event table.

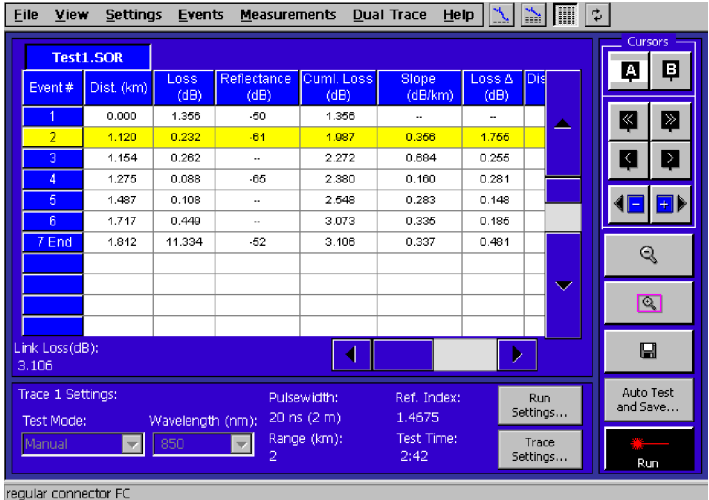

Figure 2-4: Event Table Only view

Table 2-3: Event Table column definitions

Column	Definition
Event#	Event numbers correspond to event markers or landmarks in the trace area.
Dist.	Distance represents the distance from the front panel to the event or landmark.
Loss	Loss lists the loss of optical power at an event due to scattering, absorption, and bending.
Reflectance	Reflectance lists the ratio of reflected optical power to incident optical power for reflective events.
Cuml. Loss	Cumulative Loss lists the total loss from the front panel up to and including this event.
Slope	Slope lists the attenuation of the fiber between an event and the preceding event.
Loss Δ	Loss Delta lists the loss between an event and the preceding event.
Distance Δ	Distance Delta lists the distance between an event and the preceding event.
Event Notes	Event Notes displays the Comments field of the Event / Landmark Notes dialog box.

Table 2-4: Event Table symbols and highlights

Mark	Definition
e	An “e” appears next to an <i>echo event</i> .
g	A “g” appears next to a <i>grouped event</i> .
*	An asterisk (*) appears next to any manually adjusted values in the table.
L	An “L” appears next to <i>landmarks</i> that you have manually added to the table.
End	“End” marks the event at the end of the fiber. See page 3-17 for an explanation of grouped end events.
OOR	Out of Range. Occasionally, on very long fibers, the OTDR cannot detect the end of the fiber because the resolution is insufficient. The phrase “Out of range” will appear in the event table. If this happens, see page 3-16 for how to increase the range.
Yellow Rows	The active event data displays in yellow.
Red Cells	Any data that surpasses the thresholds you set on the Test Settings and Limits dialog window is flagged in red.

Tutorial

In this tutorial you will learn to take a basic measurement and to analyze the results. Italicized terms are defined in the glossary.

Take a Basic Measurement



CAUTION. *To maintain the performance of fiber optic connectors, clean them every time you use them. Refer to Cleaning beginning on page C-1.*

1. Clean the instrument connector and the fiber connector.



CAUTION. *To avoid damage to the instrument, never connect a bare fiber adapter directly to the instrument.*

2. Connect the fiber.
3. Select the **Run Settings** button.
4. Select a wavelength that is appropriate for your system.
5. For Test Mode, select **IntelliTrace Plus**.
6. Enter an event loss threshold that is appropriate for your system.
7. Select **OK**.
8. Select the OTDR **Run** button.

The hour-glass cursor appears and the status bar displays “Acquiring...” and the status bar displays the elapsed time in seconds..

Analyze the Results

In this section you will learn to understand trace data, find the length of the fiber, and examine two point loss.

Examine the Trace Data

Look at events in the trace region and in the event table.

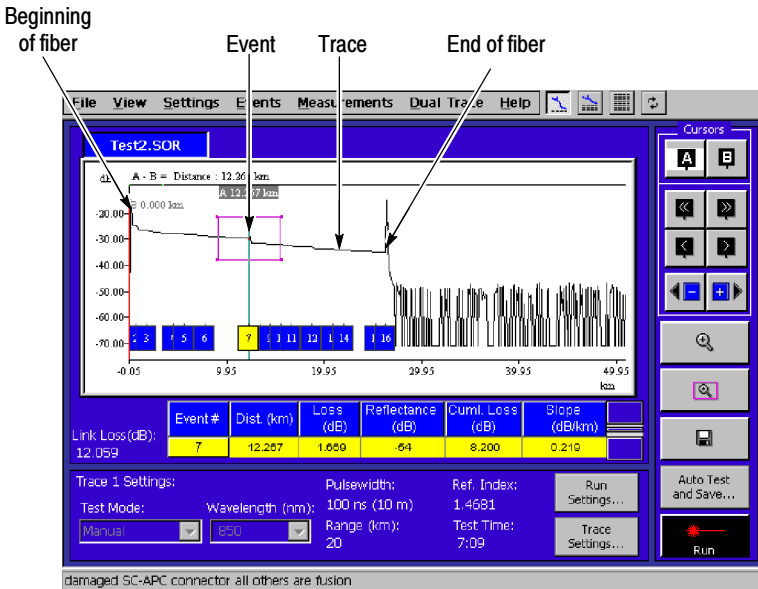

See *Changing the Proportions of the Trace and Table Regions* on page 2-5 for information on making either the trace or table area larger.

The *trace* is the line that visually represents the fiber. It typically slopes gently from the upper left of the trace region down to the lower right. From the shape and length of the trace, you can see the characteristics and length of the fiber. Sudden variations in the trace are marked as events.

An *event* is an irregularity along the fiber such as a connector or a bend. Each event is marked with a numbered square at the appropriate distance along the horizontal axis of the trace region, representing its distance along the fiber. Each numbered square event marker correlates to a numbered row of data in the event table. The event table lists the distance, loss, reflectance, cumulative loss, and slope for each event on the fiber.

The OTDR displays an event when the *event loss* (a drop in the power) or *reflectance* (an increase in the power) is greater than the Event Loss or Reflectance thresholds that you set. (See page 2-21 for information about setting thresholds.)

Find the Length of the Fiber

The last event usually marks the end of the fiber; the distance of the end event is the length of the fiber.

In the event table, look at the distance of the event marked “End.”

Alternatively, in the trace region, look at the event where the trace drops abruptly and is followed by noise.

Occasionally the OTDR may indicate that the end of the fiber is out of range. If this occurs, refer to *Increasing the Range* on page 3-16.

Examine the Two-Point Loss

Look at the loss between two points on the trace:

Be sure both cursors are on *backscatter* regions of the trace.

1. Zoom in on the area of the trace. (Refer to *Zooming* on page 2-7.)
2. Select **Measurements > Two Point...**
3. Drag a cursor or use the cursor buttons to place a cursor on backscatter to the left of an area of interest on the trace.
4. Use the  cursor buttons to toggle the active cursor.
5. Place the second cursor on backscatter to the right of the area of interest on the trace.
6. Look at the top line of the trace region for the readouts of distance, two point loss, and slope between the two cursors.

Examine an Event

Select an event to make it active. The active event will be highlighted in the event table and in the trace region so you can compare the event data to the visual representation of that event.

To select an event, do one of the following:

- Tap a row in the event table.
- Tap the event marker in the trace region.
- Move a cursor to the event marker in the trace region.

Examine the Event Table Data

Select **View > Event Table Only** to hide the trace and show only the event table. Examine the data in the event table. Take note of any data highlighted in red (black on monochrome screens) or event numbers marked with an “e”, “g”, or “*”.

Refer to *Event Table Columns* on page 2-12 for more information about the table data and the meanings of symbols and highlighting.

Configuring the Settings and Saving and Opening Files

Settings tabs (in the Test Settings and Limits dialog box) allow you to switch between different settings configurations as you acquire new traces. See *Configuring Settings* below.

You can save a trace with settings, or you can save the settings alone. See page 2-29 for information about saving files.

You can open a trace with settings, or you can open the settings alone. See page 2-33 for information about opening files.

Configuring Settings

The several settings tabs allow you to switch between different settings configurations as you acquire new traces.

Open the Test Settings and Limits dialog box by selecting **Settings > Test Setting and Limits**, and then one of the following choices:

- Run 1. Opens a tab displaying the settings that will be used by the next trace you acquire in the first mainscreen tab. (You will use this tab most of the time.)
- Trace 1. Opens a tab displaying the settings used by the current trace in the first mainscreen tab.
- Run 2. Opens a tab displaying the settings that will be used by the next trace that you acquire in the second mainscreen tab. (You can acquire traces in the second mainscreen tab when you turn Dual Trace mode on or when you use the Auto Test and Save feature for two wavelengths.)
- Trace 2. Opens a tab displaying the settings used by the current trace in the second mainscreen tab. This choice is only available if a second trace is open.

The Run tabs show the test settings for the next trace you will acquire. See Figure 2-5.

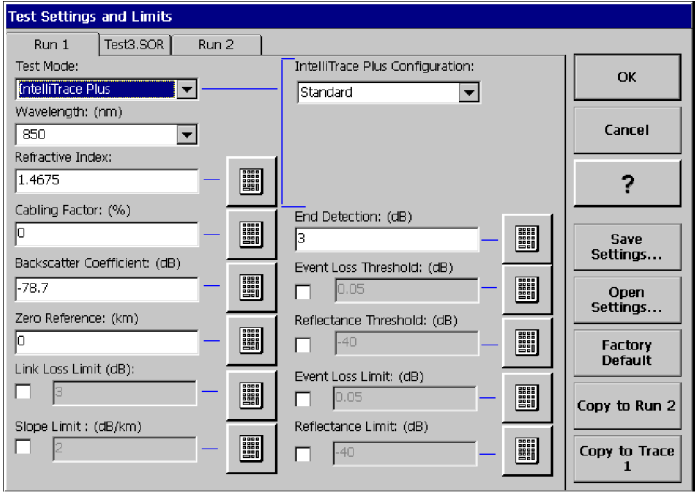

Figure 2-5: A Run tab of the Test Settings and Limits dialog box

The trace tabs show the test settings for a trace that you have already acquired. See Figure 2-6. If you have saved the file, then the test tab is labeled with the file name. If you have not yet saved the file, then the tab is labeled either Trace 1 or Trace 2.

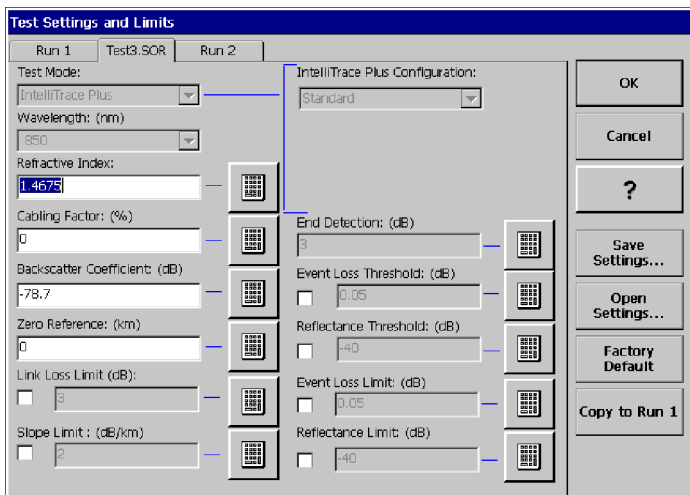

Figure 2-6: A Trace tab (labeled with the file name) of the Test Settings and Limits dialog box

Settings that Affect How Data is Collected

In the Test Settings and Limits dialog box, you can set a number of parameters which will affect how test data is collected:

NOTE. *Because these settings affect how data is collected, you can not change these test settings in the trace tabs. The trace tabs represent the settings for traces that you have already acquired.*

- **Test Mode.** Refer to Table 2-5 for information about each test mode.

You can also set the test mode from the main screen drop-down menu; however, to specially optimize IntelliTrace Plus mode for Fastest or Standard, you must use the Test Settings tab.

- **Pulsewidth.** The duration in time (ns) that the laser pulses the fiber. Longer pulse widths provide greater range; shorter pulse widths provide shorter *loss dead zones* between events.
- **Range.** From the drop-down box, select the shortest length that is greater than the length of the fiber you will test.
- **Test Time.** Longer test times will give you more *averaging* which reduces noise and increases the usable range.
- **Wavelength.** Select the wavelength of light with which to test.
- **End Detection.** Enter the signal level threshold for End Detection. When the signal drops at a single point below this threshold, the OTDR will indicate the end of the fiber.

Table 2-5: Choosing the Test Mode

Test Mode	Purpose
IntelliTrace Plus Fastest ¹ Standard ¹	To automate a measurement; the OTDR picks the best settings. You can optimize IntelliTrace Plus for different needs. In the IntelliTrace Plus Configuration field, choose from: For the shortest test time but not the best resolution For fairly good resolution and a reasonably quick test
Manual	To control your own test settings. You must set Pulse Width, Range, and Test Time.
End of Fiber	To quickly measure the length of the fiber.
Real Time	To look at a signal that changes with time. In real time acquisition, there is no averaging. For example, you can see changes in the trace as you manipulate the fiber or as you adjust a connection. To stop acquisition, select the Stop button. When you have two trace files open, you cannot take Real Time measurements. Select Dual Trace > Remove Trace 2 to close the second tab.

¹ **These optimizations are only available from the Test Settings tab.**

Settings that Affect How Data is Displayed

In the Test Settings and Limits dialog box, you can set a number of parameters that affect how test data is displayed:

NOTE. *Because these settings do not change how you acquire the test data, you can change these settings in either Run or Trace tabs.*

- **Refractive Index.** Enter the refractive index specification of the fiber.
- **Cabling Factor.** Enter the percent of extra fiber compared to the sheath measurements. (The OTDR measures the length of the fiber, which, because it twists, is longer than the length of the sheath.)
- **Backscatter Coefficient.** Enter the backscatter coefficient specification of the fiber. (This affects only reflectance measurements.)
- **Zero Reference.** Enter the Zero Reference (the length of optical fiber between the OTDR and the link you are testing).

Select or clear the checkbox for each limit or threshold. The checkboxes are global; changing a checkbox in one tab (for example, Run 1) changes that checkbox in all the other tabs to the same state. When the checkbox is not checked, the associated edit box is grayed out. Either check the box or tap the numeric keypad button next to the edit box to turn on the checkbox and then edit the checkbox contents.

Limits. Select the limit settings to highlight in red the out-of-limit data in the event table or in the Link Loss display.

You can set these limits:

- **Link Loss Limit.**
- **Slope Limit.**
- **Event Loss Limit.**
- **Reflectance Limit.**

Thresholds. Select the threshold settings to control whether a possible event will be displayed or not. All possible events are determined; the thresholds only control which of those events are displayed. If you want to display all possible events (regardless of loss or reflectance value), uncheck the Event Loss Threshold box. This disables (grays out) the Threshold value (indicating that it now has no effect on displayed events) and shows all events.

You can set these thresholds:

- **Event Loss Threshold.** Enter the Event Loss Threshold for displaying events. If the trace shows a loss of more than the Event Loss number, the OTDR will display an event.
- **Reflectance Threshold.** Enter the Reflectance Threshold for displaying events. If the trace shows a reflectance more than the Reflectance number, the OTDR will display an event.

Copying Settings to Other Tabs

In the Test Settings and Limits dialog box, you can copy the settings from the active tab to the other tabs by tapping the Copy to Run button or the Copy to Trace button.

In the Test Settings and Limits dialog box, there can be as many as four tabs, as shown in Figures 2-5 and 2-6. You can designate the settings differently in each of these tabs. The checkboxes for the limits settings change globally for all four tabs, but the other fields change independently for each tab.

You can change any setting in a Run tab and use these settings for your next acquisition. Each Trace tab represents the settings of a trace that you have taken or opened, so some of these settings cannot be changed; they are grayed out.

When you tap the Copy to Trace button, some settings will only be applied to the target Trace tab if the wavelength is the same in both the active tab and the target tab.

NOTE. *Avoid copying a settings file with a wavelength that is not supported by your OTDR module. If you do, the wavelength dependent values listed below will change, but the default valid wavelength for your module will be used. Most likely, you would end up with settings that are different from what you had intended.*

The following settings are wavelength dependent:

- Pulse-width (for manual test mode)
- Averages (for manual test mode)
- Refractive Index
- Backscatter Coefficient
- End Detection
- Slope Limit
- Link Loss Limit

Saving Tests and Settings

You can save tests with test settings, or you can save the test settings alone. All files that you save are Telcordia compliant. For more information, refer to *About File Types* on page 3-22.

Save a Test

To save the test in the active trace tab, select **File > Save As** or press the disk icon.

When you save a test, the following information is saved to a file: the trace, event table, test measurements, events, event notes, landmarks, landmark notes, fiber notes, test settings and limits, cursor positions, cursor selection, and zoom box size.

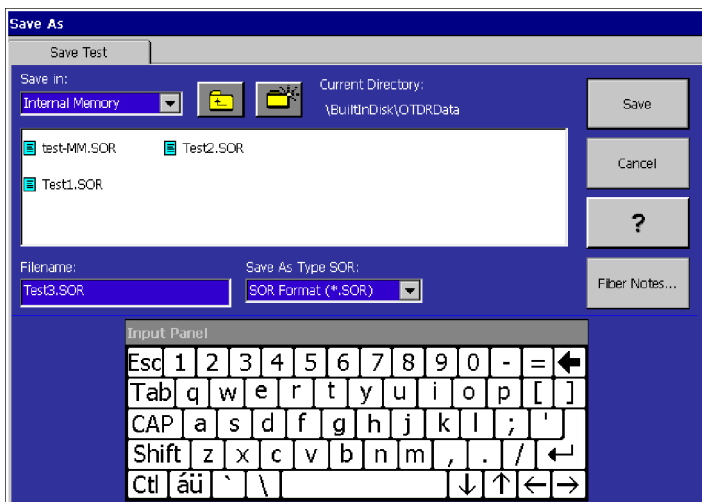

In the Save As dialog box, proceed as follows:

NOTE. *When storing files or creating folders in the BuiltInDisk folder, you should limit the number of files and folders within the root directory of the folder to between 30 and 40. When storing files and folders in a PCMCIA memory card, you should limit the number of files and folders in the root directory to about 60. Store files in subdirectories, in which there is effectively no limit to how many files can be stored.*

1. In the **Save in** field, select the location where you want the file saved. Use the folder icons to navigate to a higher level of folder or to create a new folder. The list box below the field displays the names of existing files in the selected folder.

NOTE. *Save files in \BuiltInDisk, on a floppy disk, or on a PC card. Files saved anywhere else will be lost when you power off the NetTek Analyzer.*

2. Enter a filename in the Filename field.
3. If you want to add or edit notes about the fiber, select the **Fiber Notes...** button, enter information about the fiber, and tap **OK**.
4. Tap the **Save** button.

Save Settings Only

You can save frequently used test settings and limits to a file that you can reuse.

Select **Settings > Save Settings** and then select the settings tab that you want to save:

- Run 1
- Trace 1
- Run 2
- Trace 2

NOTE. *When storing files or creating folders in the BuiltInDisk folder, you should limit the number of files and folders within the root directory of the folder to between 30 and 40. When storing files and folders in a PCMCIA memory card, you should limit the number of files and folders in the root directory to about 60. Store files in subdirectories, in which there is effectively no limit to how many files can be stored.*

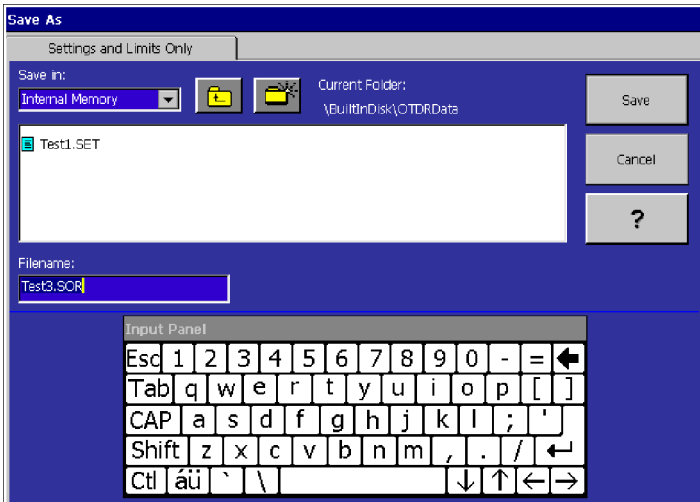

NOTE. Save files in `\\BuiltInDisk`, on a floppy, or on a PC card. Files saved anywhere else will be lost when you power-off the NetTek Analyzer.

Test data is not saved from this tab; use the Save Test tab instead.

1. In the Save in field, select the location where you want the file saved. Use the folder icons to navigate to a higher level of folder or to create a new folder. The list box below the Save In field displays the names of existing files in the selected folder.
2. In the Filename field, enter a filename. The file extension .set indicates that this file contains only settings and limits data (no test data).

All the test settings and limits from the Test Settings and Limits dialog box are saved to your file.

Opening Trace or Setting and Limit Files

You can open files from floppy disk, internal memory, or a storage card. You can open a trace file or a settings and limits file. For more information, refer to *About File Types* on page 3-22.

Opening a Trace File

Select **File > Open**.

From this tab, you can open .SOR files containing settings, limits, and trace data. You can also open .CFF or .WFM files to view.

1. From the Look in: box, select the floppy disk, internal memory, or the storage card. The contents of the folder will appear in the box below. Tap a folder to open it. If you want to back up to a higher level of folder, use the folder icon. Tap the file name you want to open.

The fields on the right side of the dialog box give you a preview of information related to the highlighted file.

If you have trouble finding a file, use the Files of Type drop-down box to limit the files displayed to SOR Format or CFF Format, or you can expand the types of files that are visible by choosing All Files.

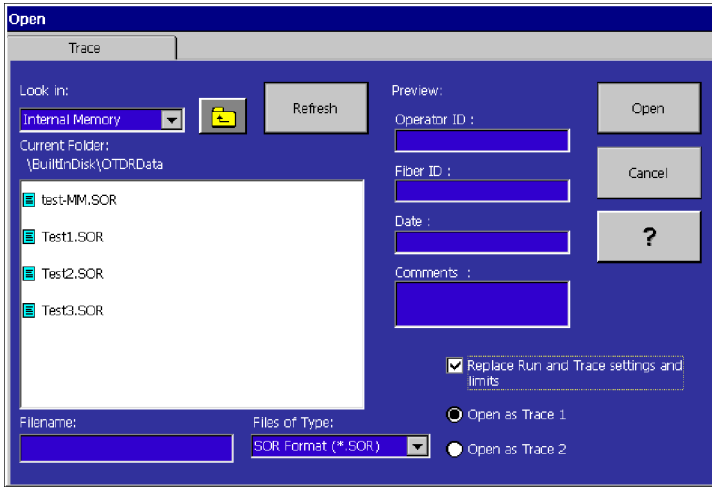

2. Select **Replace Run and Trace settings and limits** to make the test settings and limits of the saved trace file the default ones used when you acquire the next trace and to apply the saved settings to the trace. If this box is not checked, none of the settings are changed from the last settings saved for the wavelength of the file (see About Trace to see the file settings).
3. Select **Open as Trace 1** or **Open as Trace 2**.
4. Tap **Open** to open the highlighted file name.

Opening a Settings Only File

You can open .SET files. These .SET files are smaller than .SOR or .CFF files, which also contain trace data.

Select **Settings > Open Settings**, and then select which tab to open the settings into:

- Run 1. Select if you want the next trace you acquire in the first tab to use the settings that you open.
- Trace 1. Select if you want the current trace in the first tab to use the settings that you open.

- **Run 2.** Select if you want the next trace you acquire in the second tab to use the settings that you open. (You can acquire traces in the second tab when you turn Dual Trace mode on or when you use the Auto Test and Save feature for two wavelengths.)
- **Trace 2.** Select if you want the current trace in the second tab to use the settings that you open.

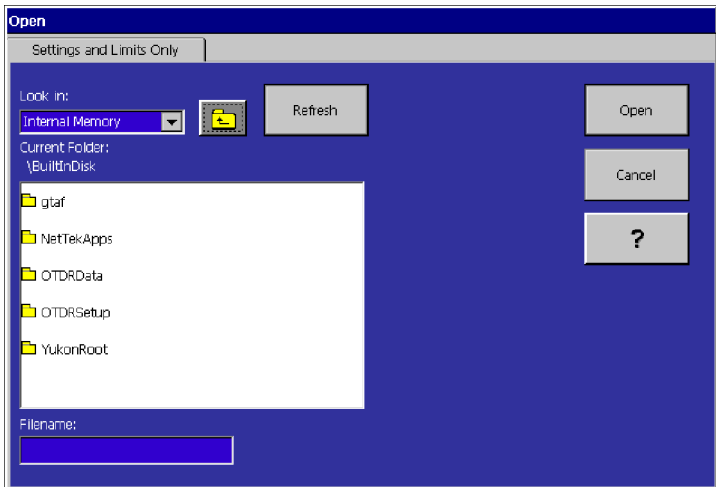

1. From the Look in: box, select the floppy disk, internal memory, or the storage card. The contents of the folder will appear in the box below this field.

Tap a folder to open it. If you want to back up to a higher level of folder, use the folder icon.

If you insert a floppy disk or a storage card, tap the Refresh button to see the contents.
2. Double-tap the file name you want to open.

Determine Which Settings Were Used for a Trace

Select **Settings menu > About Trace**.

This dialog box displays all the static settings that were used to acquire the trace and all the dynamic settings that were saved with the trace.

Examine the Test1.SOR, Test2.SOR, and Test-MM.SOR Files

In this section you will look at three sample files provided with your OTDR:

- Test1.SOR illustrates that different types of events can look similar.
- Test2.SOR illustrates a damaged angle-polished splice.
- Test-MM.SOR illustrates a multimode fiber with a number of events, including echoes and grouped events.

Starting with Test1.SOR, in the following steps, you will compare the appearances of each event in the trace and compare the amounts of loss and reflectance of each event in the event table.

1. Open Test1.SOR from Internal Memory. (Select **File > Open**, then Look in: **Internal Memory**, and double-tap **Test1.SOR**.)
2. Look at the seven events. You will see something similar to Figure 2-7.

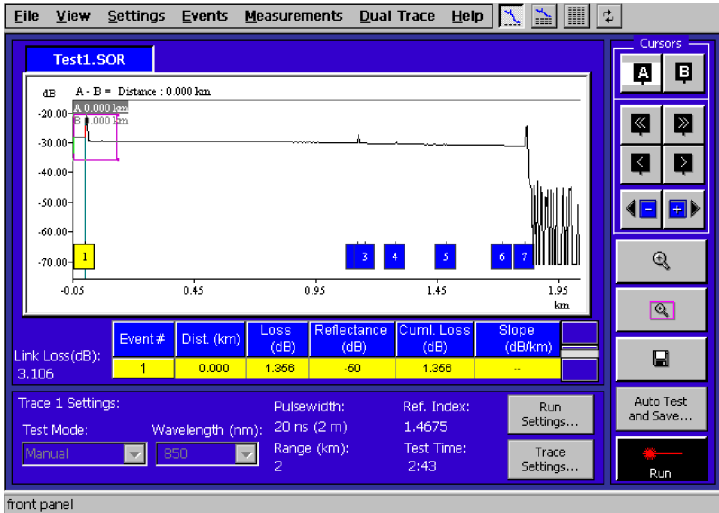

Figure 2-7: Sample file Test1.SOR illustrates that different types of events can look similar

- Switch to Event Table Only view to compare the event loss and reflectance values of each event. (Select **View > Event Table Only**.) You will see something similar to Figure 2-8. You can scroll to the right to view a description of each event in the Event Notes column.

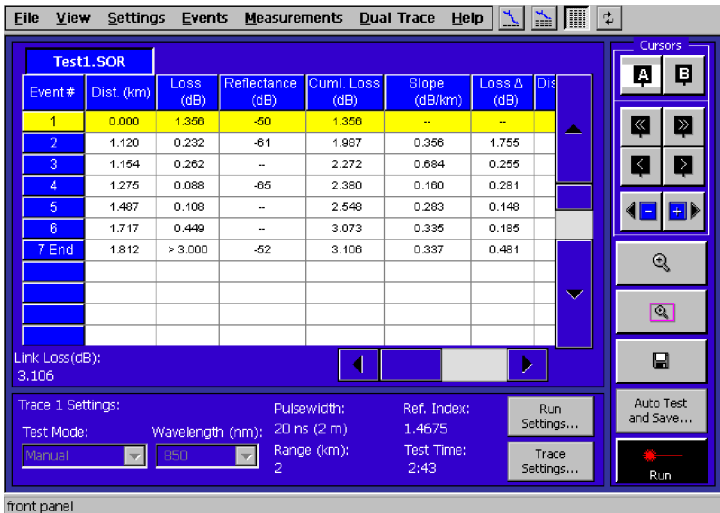







Figure 2-8: Compare the amounts of loss and reflectance in each of the events in the sample file Test1.SOR

- Switch back to the trace view again. (Select **View > Maximize Trace**.)

The first event is the beginning of the fiber at the front panel.

5. Starting with the second event, select each event in turn and zoom in. Tap  to zoom in, and then tap  to zoom in. Tap  to zoom in, and then tap  to adjust the size of the zoom box. Tap the down arrow, , several times to maximize the appearance of small reflections and losses.

Event 2, shown in Figure 2-9, is an FC regular connector. It has fairly large amounts of both loss and reflection.

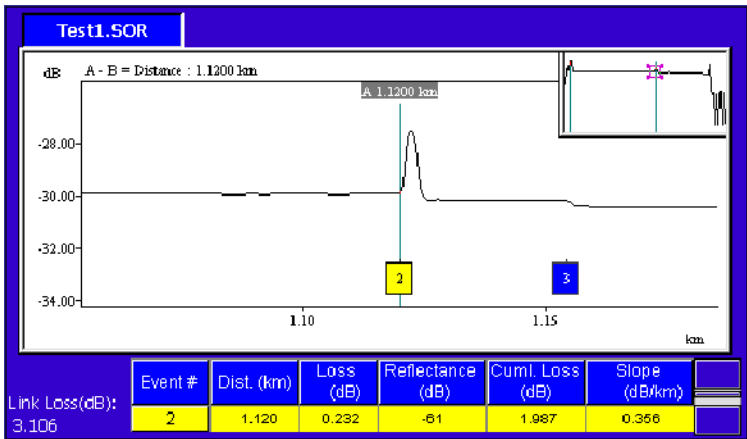

Figure 2-9: Event 2 is an FC regular connector

Event 3, shown in Figure 2-10, is a fusion splice. It has a small amount of loss and no significant reflectance.

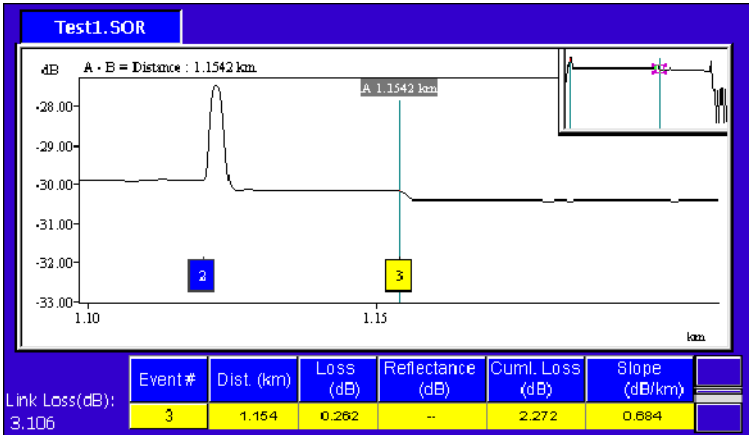

Figure 2-10: Event 3 is a fusion splice

Event 4, shown in Figure 2-11, is a mechanical splice. Like the FC regular connector, it has large amounts of both loss and reflection.

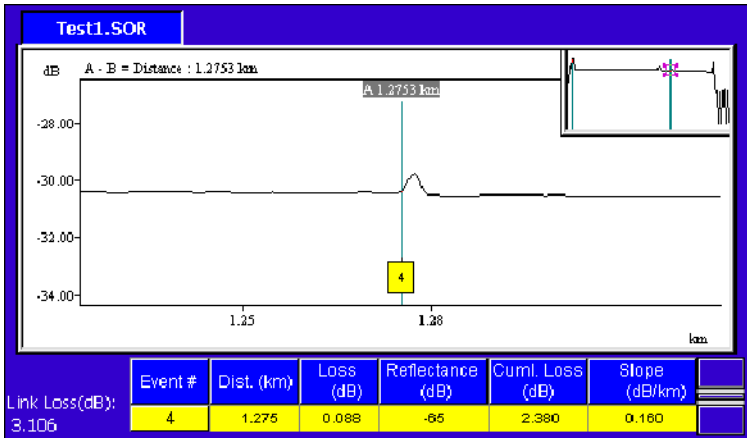

Figure 2-11: Event 4 is a mechanical splice

Event 5, shown in Figure 2-12, is a bend. Like the fusion splice, the bend has a very small amount of loss and no significant reflectance.

On singlemode fiber, testing with multiple wavelengths is a good way to tell if an event is a bend. In contrast to fusion and mechanical splices, the slope and loss values of a bend will differ depending on the wavelength you use for testing.

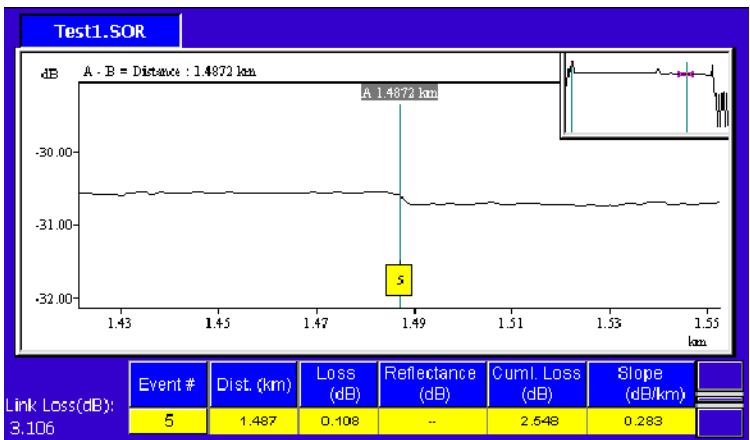

Figure 2-12: Event 5 is a bend

Event 6, shown in Figure 2-13, is another fusion splice like Event 3. It has a large amount of loss but no reflectance.

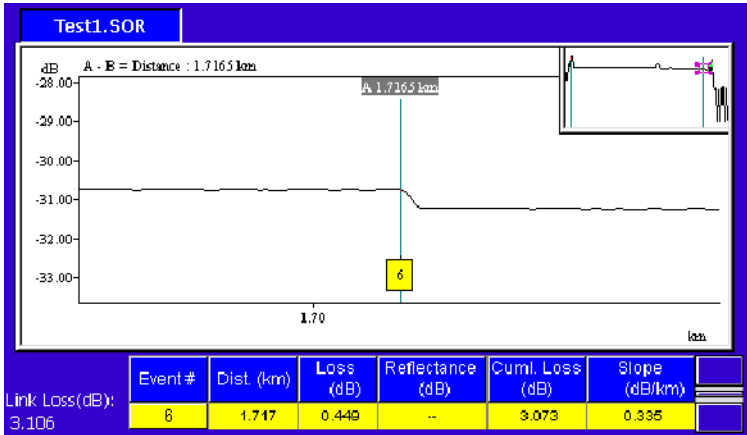

Figure 2-13: Event 6 is a fusion splice

Event 7, shown in Figure 2-14, is the end of the fiber. Notice that it has large values for both loss and reflectance. The trace power level drops off into noise at the end of the fiber.

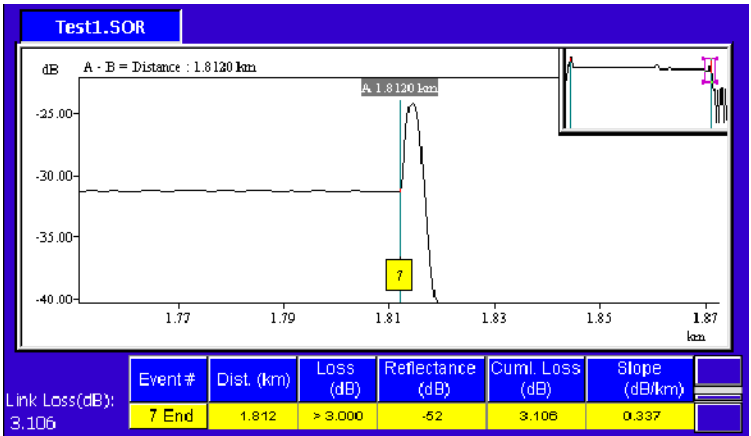

Figure 2-14: Event 7 is the end of the fiber

6. Open Test2.SOR from Internal Memory. (Select **File > Open**, then Look in: **Internal Memory**, and double-tap **Test2.SOR**.)
7. Look at the 16 events. You will see something similar to Figure 2-15.

In the sample file, Test2.SOR, events 1 and 16 represent the beginning and ending of the fiber, respectively. All the other events are fusion splices except event 7, which is an angle-polished splice. Usually angle-polished splices have no reflectance. In this case, however, the ends are worn. This damage accounts for the large amount of reflectance you see in Figure 2-15.

You can switch to Event Table Only view and scroll to the right to view a description of each event in the Event Notes column.

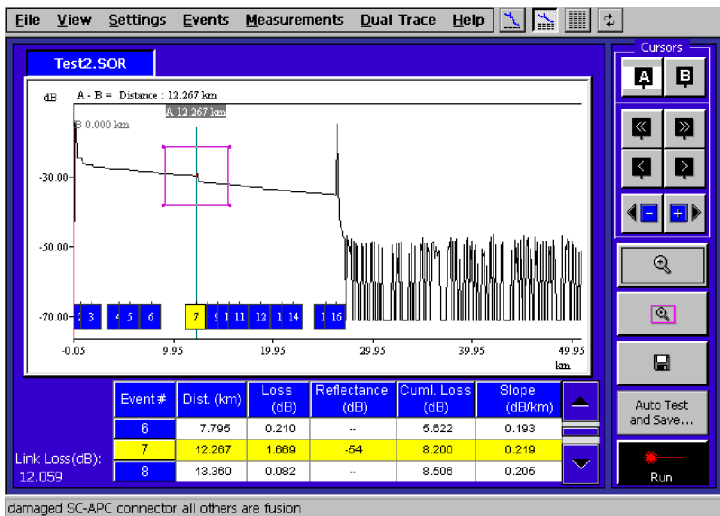

Figure 2-15: Sample file test2.SOR shows a worn angle-polished connector (Event 5) and several fusion splices

8. Open Test-MM.SOR from Internal Memory. (Select **File > Open**, then Look in: **Internal Memory**, and double-tap **Test-MM.SOR**.)
9. Look at the 10 events. You will see something similar to Figure 2-16.

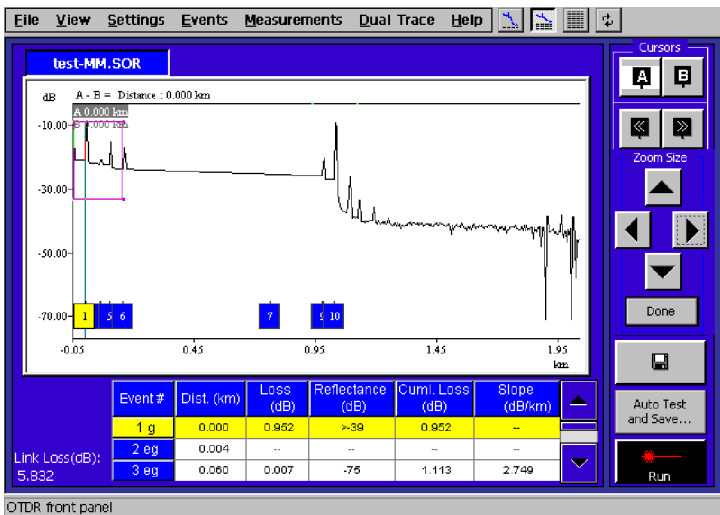

Figure 2-16: Sample file Test-MM.SOR shows several types of events on a multimode fiber

10. Switch to Event Table Only view and scroll to the right to view a description of each event in the Event Notes column. You will see something similar to Figure 2-17.

test-MM.SOR				
Event #	Slope (dB/km)	Loss Δ (dB)	Distance Δ (km)	Event Notes
1 g	--	--	--	OTDR front panel
2 eg	--	--	0.004	Jumper cable to patch panel
3 eg	2.749	0.154	0.056	Echo from front panel
4 eg	--	--	0.003	Echo from front jumper cable
5	2.722	0.104	0.038	Poor patch panel connector
6	3.099	1.378	0.058	Good patch panel connector
7	2.621	1.720	0.604	Good fusion splice
8 g	2.625	0.618	0.213	Pigtail splice grouped with connector
9 eg	--	--	0.004	Connector grouped with splice
10 End	2.955	0.143	0.049	End of fiber

Link Loss(dB): 5.832

Figure 2-17: Look at the event notes in the event table of sample file Test-MM.SOR

11. Select **View > Split Trace and Event Table** and zoom in on events 1 and 2.

Events 1 and 2 are grouped (marked “g”) due to the short distance between them. Event 1 is the connector on the OTDR. Event 2 is a jumper cable.

Often a jumper cable is used to connect the OTDR to the system patch panel. If the cable is short (it is 4 meters in this example), the loss measurement will be grouped with the front panel loss.

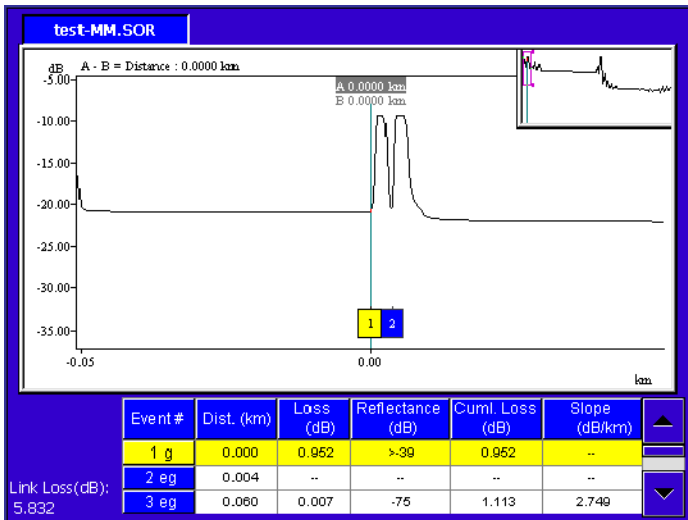

Figure 2-18: Event 1 (the front panel) and Event 2 (a jumper cable) are grouped due to the short distance between them

12. Look at events 3 and 4 shown in Figure 2-19.

Event 3 is an echo from Event 1, the front panel.

Event 4 is an echo from Event 2, the jumper cable.

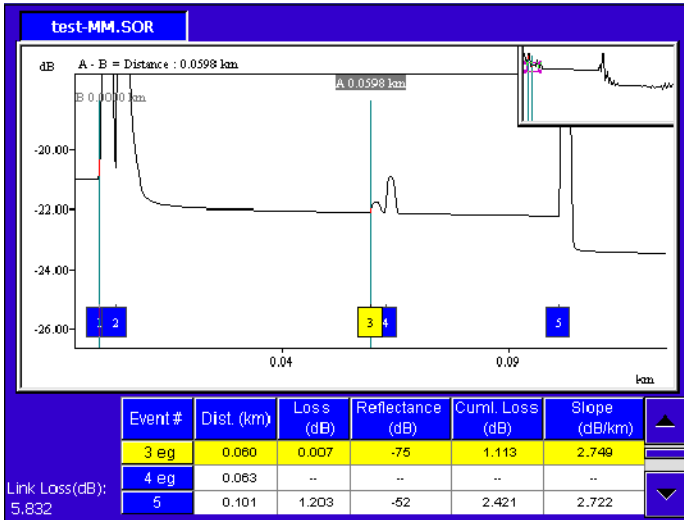

Figure 2-19: Events 3 and 4 are echoes of 1 and 2 and are grouped with each other

13. Look at Events 5 and 6 shown in Figure 2-20.

Event 5 is a patch panel connector with higher than normal loss.

Event 6 is a patch panel connector with low loss.

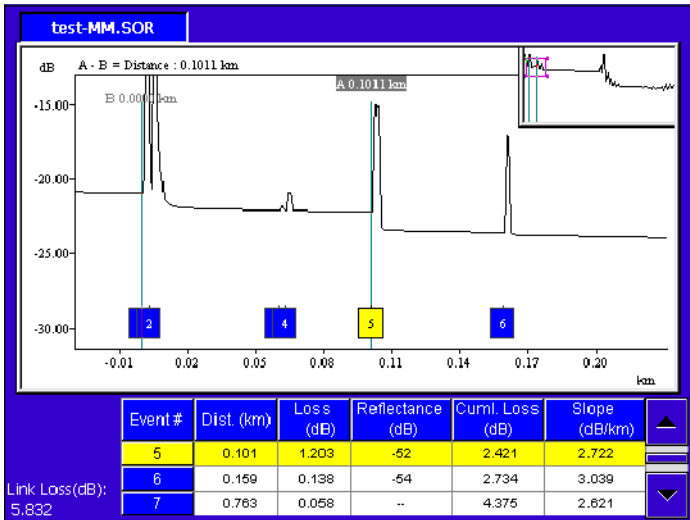

Figure 2-20: Event 5 (high loss) and Event 6 (low loss) are both patch panel connectors

14. Look at Event 7 shown in Figure 2-21.

Event 7 is a good (low loss) fusion splice. Note that there is no reflection peak as with connectors. Fusion splices and bends have losses without reflections.

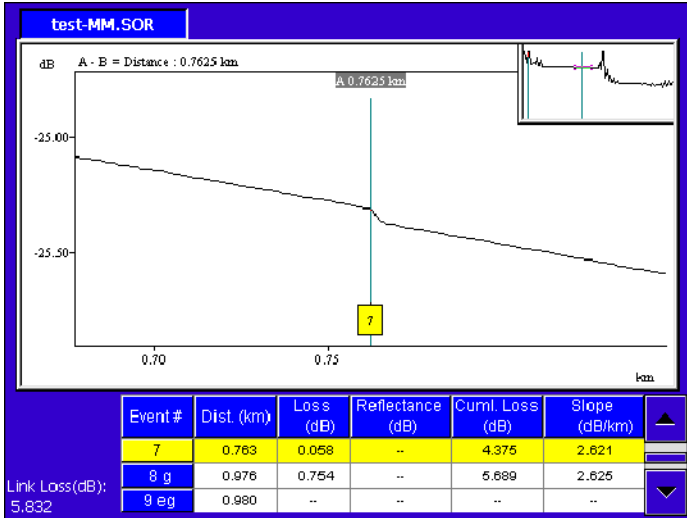

Figure 2-21: Event 7 is a good (low loss) fusion splice

15. Look at events 8, 9, and 10.

Event 8 is a pigtail fusion splice. Sometimes, instead of installing a connector on the fiber, a pigtailed connector is spliced onto the system. A pigtail is a jumper cable with a factory installed connector on a section of fiber. This section of fiber is fusion spliced onto the system as a way of installing the connector. Event 8 is the pigtail fusion splice that goes with the connector at Event 9. Note that you can see the fusion splice before the connector, but it is less likely to see a fusion splice after the large reflection of the connector (Event 9).

Event 9 is a patch panel connector. It is grouped with the pigtail splice at event 8 due to the short distance between the two events.

Event 10. This is the end of the fiber. If you look to the right of it, you can see several more peaks. These are echoes of the end of the fiber. It is fairly common on multimode tests to have echoes after the end of the fiber.

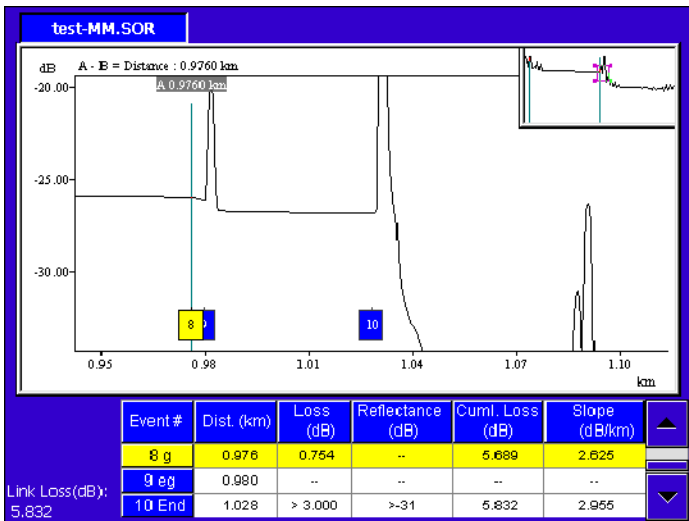

Figure 2-22: Event 8 (the start of a pigtail), Event 9 (a patch panel connector), and Event 10 (the end of the fiber)



Reference

Taking Measurements

This section covers taking measurement menu measurements (see below), comparing two traces in various ways (see page 3-8), and setting up automatic testing and saving of measurements (see page 3-12).

To perform advanced measurements, choose a measurement from the measurement menu.

These measurements are taken on one trace:

- **Event Loss:** Measures loss at a point on a fiber. See page 3-2.
- **Two Point:** Measures the loss, slope, and distance between two points on a fiber. See page 3-4.
- **Reflectance:** Measures the loss due to light reflected by a particular fiber feature, such as a connector or splice. See page 3-6.
- **ORL:(Optical Return Loss)** Measures the reflected light from a section of fiber or from the whole fiber. See page 3-7.

These measurements are taken on two traces in Dual Trace mode:

- **Bidirectional Averages:** Averages the events of two traces taken from opposite ends of the same fiber. Some events may appear differently depending on which end of the fiber you test. Use this measurement for a more accurate representation of the fiber than either trace alone can give. See page 3-9.
- **Difference:** Subtracts one trace from another. Use this measurement to compare two similar trace files. See page 3-11.

Performing Event Loss Measurements

Select **Measurements > Event Loss...**

Measures loss at a point on a fiber. The loss appears as a readout at the top of the trace.

The events that you add are marked in the event table with an asterisk (*).

Figure 3-1 shows an example of an event loss measurement.

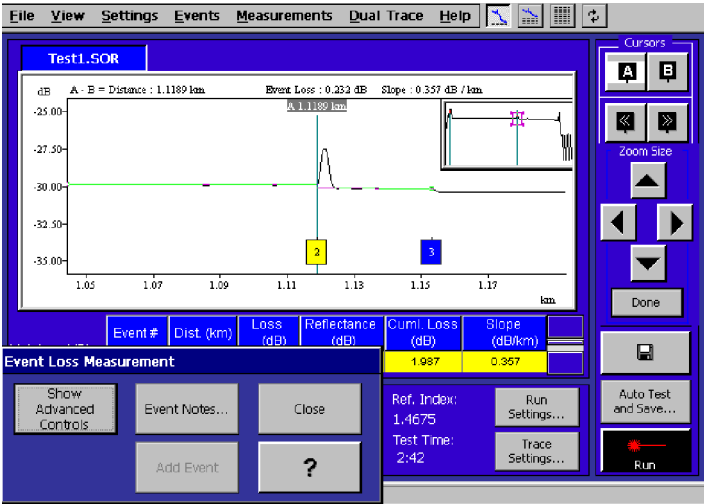

Figure 3- 1: Event Loss for Event 2

Event Loss Advanced Controls

Select **Measurements > Event Loss... > Advanced Controls** button.

Advanced Controls allow you to manually adjust the slope cursor either to the **Left** or the **Right** of the event.

Select **Reset** to return the slope cursor angles to match the backscatter slope.

Select **Update Table** to update the event table with your manually adjusted loss data. Manually adjusted data in the event table are marked with an asterisk (*).

Performing Two Point Measurements

Select **Measurements > Two Point...**

Measure the loss, slope, and distance between two points on a fiber.

Be sure both cursors are on backscatter regions of the trace.

Look at the loss between two points on the trace:

1. Zoom in on the area of the trace.
2. Select **Measurements > Two Point...**
3. Drag a cursor or use the cursor buttons to place a cursor on backscatter to the left of an area of interest on the trace.
4. Use the A/B cursor buttons to toggle the active cursor.
5. Place the second cursor on backscatter to the right of the area of interest on the trace.
6. Look at the top line of the trace region for the readouts of distance, two point loss, and slope between the two cursors.

Two Point Loss Advanced Controls

Select **Measurements > Two Point... > Advanced Controls** button.

To manually adjust the cursors, select either Two Point Slope or LSA Slope:

- Select **Two Point Slope** to measure the loss across a feature of the fiber. In two-point slope calculations, the two-point loss is divided by the two-point distance, using the data point at each intersection between the loss cursors and the waveform. This type of calculation is better if there are reflective events close to the one you are trying to measure.
- Select **LSA Slope** to measure fiber loss on featureless sections of backscatter. In LSA slope calculations, the data points on the waveform between the distance cursors are used to determine the best-fitting straight line using the least-squares average algorithm. This type of calculation is better if the trace is noisy and there are no reflective events close to the one you are trying to measure.

Using the scroll bar to move the cursor vertically and the knob buttons to rotate the cursor, match the angle and position of the cursor to the slope and level of the backscatter.

Use the double arrow side of the knob to rotate the cursors by large increments. Use the single arrow side of the knob to rotate the cursors by small increments.

Select **Reset** to return the loss cursor position to match the automatically determined level of the backscatter.

Performing Reflectance Measurements

NOTE. Before performing reflectance measurements, be sure that the backscatter coefficient setting is correct in the Test Settings tab.

Select **Measurement > Reflectance...**

Measure the reflectance at a point on a fiber, such as at a connector or splice.

Place a cursor at the point of interest on the trace. The reflectance from that point appears as a readout at the top of the trace region.

Reflectance Advanced Controls

Select **Measurements > Reflectance... > Advanced Controls** button.

Advanced Controls allow you to manually adjust the slope cursor either to the **Left** or the **Right** of the event.

Select **Reset** to return the slope cursor angles to match the backscatter slope.

Select Update Table to update the event table with your manually adjusted reflectance data.

Manually adjusted data in the event table are marked with an asterisk (*).

Performing ORL Measurements

NOTE. Before performing reflectance measurements, be sure that the backscatter coefficient setting is correct in the Test Settings tab.

Select **Measurements > ORL**.

Optical Return Loss measures the reflected light from a section of fiber or from the whole fiber. This measurement tells you how much noise is on the fiber.

The ORL readout appears at the top of the trace region.

Compare Two Traces

There are several ways you can compare two traces:

Bidirectional Average Measurements

This measurement averages the events of two traces taken from opposite ends of the same fiber. Use this measurement when you need especially precise splice loss measurements. Select **Measurements > Bidirectional Averages**. See page 3-9 for more information.

Difference Measurements

This measurement subtracts one trace from another. Use this measurement to compare two similar trace files. Select **Measurements > Difference**. See page 3-11 for more information.

Dual Trace Mode

Use Dual Trace mode to view and compare two trace files within one tab.

1. Open or acquire a trace.
2. Select **Dual Trace > Dual Trace On**.
3. Open or acquire a second trace.
4. Select the tab of the trace data you want to be active. (The two tabs above the trace region are each named for one of the traces.)

The event markers of the active trace are dark and the event markers of the inactive trace are light. The event table shows the events of the active trace data.

Select **Dual Trace > Dual Trace Off** to look at only one trace at a time within the same tab. Select **Dual Trace > Remove Trace 2** to close the second tab. (When you have two trace files open, you cannot take Real Time measurements.)

Performing Bidirectional Averages Measurement

Select **Measurement > Bi-directional Averages**.

Events may appear differently depending on which end of the fiber you test. Take trace measurements from each end of a fiber, and then use the Bidirectional Averages function to view the average losses of the two trace files. The averaged event loss values yield a more accurate representation of the fiber than either trace alone. This measurement generates a third tab with a trace and event table showing the averages of the two trace files.

Refer to Figure 3-2 for an example of a bidirectional averages measurement.

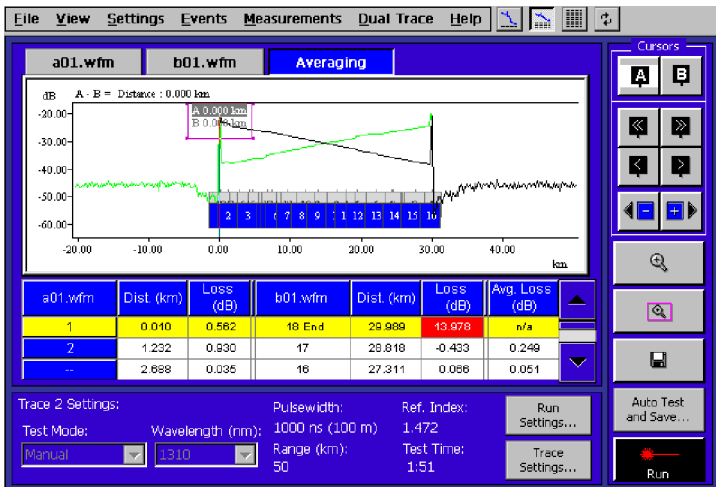

Figure 3-2: Bidirectional Averages traces

1. Open or acquire a trace.
2. Select **Measurement > Bi-directional Averages**.
3. Open or acquire a second trace taken from the opposite end of the fiber from step 1.
4. View and interpret the bidirectional averages trace and event table data in the third tab.

NOTE. *You cannot save the third tab as a file. Instead, save the separate traces; you can regenerate the data at any time from the saved trace files.*

The Bidirectional Averages tab displays the two traces (taken from both ends of the same fiber) and the average of the two traces. The two traces are represented in opposite directions. The end of one trace is the beginning of the other trace, and the two traces meet in the middle.

The trace from the first tab will appear as usual, starting in the upper left corner and sloping down to its end in the lower right corner. The trace from the second tab looks like a superimposed mirror image of the first. It starts in the upper right corner and slopes down to its end in the lower left, and its events should line up vertically with the events from the first trace.

When the third tab is active, the event table shows the averages of each event. If an event appears on one of the traces but not at the corresponding distance on the other, "--" appears in the table cell.

Performing Difference Measurements

Select **Measurement > Difference**.

NOTE. *You must have two files open to create difference data.*

You cannot save the third tab as a file, but you can regenerate the data at any time from the saved trace files.

The Difference function subtracts the second trace from the first and displays the results as a third trace. Look at the difference to compare two similar trace files, such as traces taken on the same fiber at different times, or traces taken on adjacent fibers in the same cable. This measurement generates a third tab with a trace and event table that show the difference between the two trace files. The difference in the event loss values show you changes in the fiber between the acquisitions or the differences between two adjacent fibers.

The settings in the Trace 1 settings tab apply to both traces in difference measurements.

To perform a difference measurement:

1. Open or acquire a trace.
2. Select **Measurement > Difference**.
3. Open or acquire a second trace.
4. Select the third tab to view the difference data.

The tabs above the trace region are labeled with the file name of the trace data. Select the tab of the trace data you want to be active. The event markers of the active trace are dark and the event markers of the inactive trace are light. The event table shows the events of the active trace data.

Auto Test and Save Dialog Box

Select **Auto Test and Save** button.

Use this dialog box to automate taking and saving numerous, similar tests. The auto test will use the test settings on the main screen.

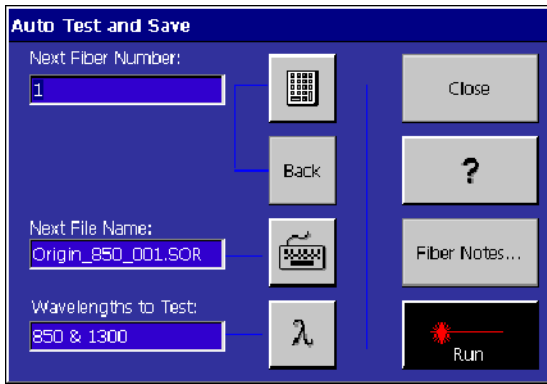

Next Fiber Number: Tells you what fiber number the OTDR will assign to the next fiber it measures. Enter the fiber number you want the OTDR to start with.

Back button. Decrements the Next Fiber Number.

Next File Name: Press the keyboard icon to access the Next File Name dialog box (shown in part below) where you enter the first part of the fiber name into the field.

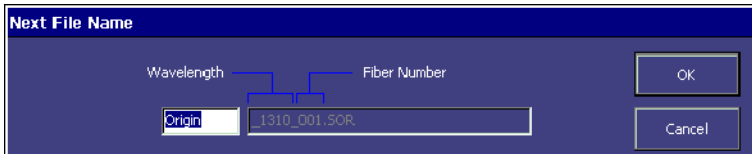

Wavelength to Test: If your module has multiple wavelength capability, select the wavelength icon to set up which wavelength or wavelengths to use.

Close button. Clears and closes the dialog box.

Fiber Notes... button. Opens the Fiber Notes dialog box where you can add to or edit notes before you save them with your test.

Run button. Begins the first test.

Auto Sequence Wavelength Choices Dialog Box

Select **Auto Test and Save button** > **λ** button.

Choose which wavelength to test in the Test First option list. If you want to test each fiber a second time with a different wavelength, select a wavelength in the Test Second option list. If you don't want to test a second time, select none in the Test Second option list.

If you choose a second wavelength to test, the second wavelength test will use the settings in the Run 2 tab.



Other Features

This section includes instructions and reference information about features you may find useful:

- Increasing the range
- Finding the end when grouped events are marked as “End”
- Getting the best resolution on multimode tests
- Printing
- Using the OTDR with a keyboard
- Joining cursors
- Setting the front panel loss warning
- Setting the distance units
- Setting Factory Defaults
- Information about file types
- Making notes on events, landmarks, and fibers
- Adding, moving, and deleting, events or landmarks

Increasing the Range

Occasionally, on very long fibers, the OTDR cannot detect the end of the fiber because the range is insufficient. “OOR” (Out of Range) will appear in the last row of the event table. If this happens, change the test settings as follows:

1. Select **Settings > Test Settings and Limits**, and then either **Run 1** or **Run 2**.
2. Select the Test Mode: **IntelliTrace Plus** or **Manual**.

If you choose IntelliTrace Plus mode, select **Standard** configuration.

If you choose Manual mode, you can do one or both of the following:

- Use a longer pulse width. This increases the range by increasing the power, but it reduces resolution.
- Increase the averaging. This increases the range slightly by lowering the noise floor, but the test will take much longer.

Finding the End When Grouped Events are Marked as “End”

For some test set ups, the end of the fiber may be marked as grouped events rather than an individual event.

In the example in Table 3-1, the software cannot tell which of the last four events is the actual end of the fiber.

Table 3-1: Sample event table with grouped end events

Event	Distance	Description
1	0.000 km	
2	0.250 km	
3gEnd	0.300 km	(In this case, this is the actual end of the fiber.)
4geEnd	0.350 km	Echo of event 2, grouped with event 3
5gEnd	0.400 km	Double echo of event 2 which are sometimes not identified as an echo, grouped with events 3 and 4
6geEnd	0.600 km	Echo of event 3, grouped with events 3, 4, and 5

If you know the length of the cable, check to see that the known length is listed as one of the events marked “End”. If you don’t know the length of the cable or if the known length is not listed, then try rerunning the test in one of the following ways:

- Switch to a shorter pulse width (separates out the events better).
- Use a matching gel or a fiber twist to dampen out the end reflection (reduces repeat echoes).
- On multimode tests, if you first tested at 1300 nm, use 850 nm for higher resolution.

Getting the Best Resolution on Multimode Tests

The resolution of 850 nm tests is significantly better than the resolution of 1300 nm tests. Even on 1300 nm networks, consider testing at 850 nm, particularly when you need to resolve events that are close together.

Compared to 1300 nm tests, 850 nm tests are more accurate on short networks because of the shorter dead zone. In 850 nm tests, the dead zones are half as long. Also, in 850 nm tests, a shorter pulse width is available; the shorter pulsewidth will give you a higher resolution test on a short fiber.

Connector loss measurements do not vary as significantly between 850 nm and 1300 nm as they do between the two wavelengths used in singlemode. The variation between event loss measurements at the two multimode wavelengths is generally less than 10%.

Though event loss does not vary significantly, fiber loss is different between the two wavelengths.

Use 850 nm to:

- Make more accurate connector and splice measurements
- Resolve close together events
- Reduce the effects of echoes and grouped events

Use 1300 nm to:

- Make section, link, or fiber loss measurements on 1300 nm networks
- Double check event loss where you can resolve events separately
- Show documentation at 1300 nm

Printing

Select **File > Print**.

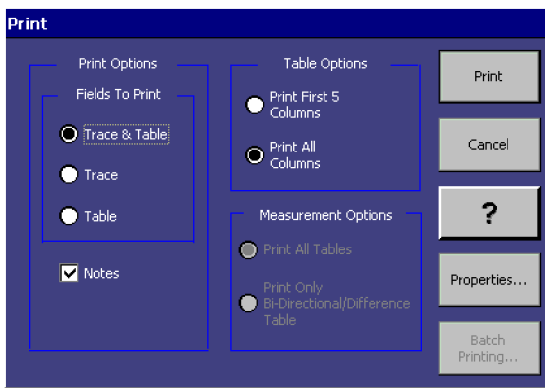

Select the fields you want to print:

- Trace and Table. This choice prints both the trace and table.
- Trace. The trace will print as it appears on screen. At least one line of the event table will print for the selected event.
- Table. Under Table Options, indicate whether to print only the first five columns or all columns. For measurements with multiple tables, select under Measurement Options whether to print all the tables or only the bidirectional or difference table.
- Notes. Select Notes to print your fiber, event, and landmark notes. Tap the Properties button to select a printer, port, network path, paper size, print mode, print range, orientation, and margins. (For additional information, select **Properties > ?**.)

Using with a Keyboard

You can operate the OTDR with an external keyboard as follows:

Connect the keyboard to the keyboard port on the NetTek Analyzer.

Access the main menus by holding down the Alt key and pressing the underlined letter of the menu name.

Use the up and down arrows to move the highlight cursor to your drop-down menu selection and then press Enter.

In a dialog box, use the tab or arrow keys to highlight the item or area of interest, and then press Enter to select it.

For example, to change the appearance of the trace, use these steps:

1. Open the View drop-down submenu: hold down Alt and press V.
2. Open the Trace Display Options dialog box: press the down arrow until the Trace Display Options menu is highlighted, and then press Enter.
3. Use the tab or arrow keys to select one of the options and then press Enter to select or clear the checkbox.

Joining Cursors

Select **View > Join Cursors**.

The inactive cursor jumps to the location of the active cursor. (The active cursor is the one labeled with white text in a black box.)

Setting the Front Panel Loss Warning

Select or clear the check in front of **Settings > Front Panel Loss Warning** to turn the Front Panel Loss Warning on or off, respectively. If you turn it off, you will not be warned before each acquisition if there is a problem with the front panel connection.

Setting the Distance Units

Select **Settings > Distance Units**, and then the unit of your choice.

Setting Factory Defaults

There are four ways to return settings to factory defaults:

- Select **Settings > Power On Settings > Factory Defaults**. This affects only the settings in the Run 1 and Run 2 tabs at power on for all wavelengths. (You can also choose Last Used.)
- Select **Settings > System Factory Defaults**. This sets all test parameters to their factory defaults, replacing any user-changed values.
- Tap the **Run Settings...** button > **Factory Defaults** button. This affects only the settings in the active Run tab for the currently selected wavelength.
- Tap the **Trace Settings...** button > **Factory Defaults** button. This affects only the settings in the active Trace tab.

About File Types

SOR Format

SOR format is a Telcordia format. When you save any file, the OTDR saves it in SOR format. This format works with the Tektronix NetTek Analyzer OTDR modules, Tektronix TARGET1 PC software, and in SOR-compliant instruments from other manufacturers. The file extension does not have to be .SOR; for example, you can use something like “.001” if you prefer.

CFF Format

CFF format is a Tektronix file format. You can read CFF files, which were created on Tektronix TFS3031 or TFP2A OTDR or with Tektronix FMTAP PC software.

SET Format

SET format includes only settings and limits; it does not include test data. Use this format to save and reuse settings and limits for multiple tests. This file type is an SOR file format; however, to reduce the file size, it contains no trace data.

WFM Format

WFM format is a Tektronix file format. You can read WFM files, which were created on early models of the Tektronix TFP2 FiberMaster OTDR.

Making Notes on Events, Landmarks, and Fibers

You can record notes about fibers or about individual events and landmarks on a trace. These notes are saved when you save the test file.

Event / Landmark Notes Dialog Box

Select **Events > Event / Landmark Notes...**

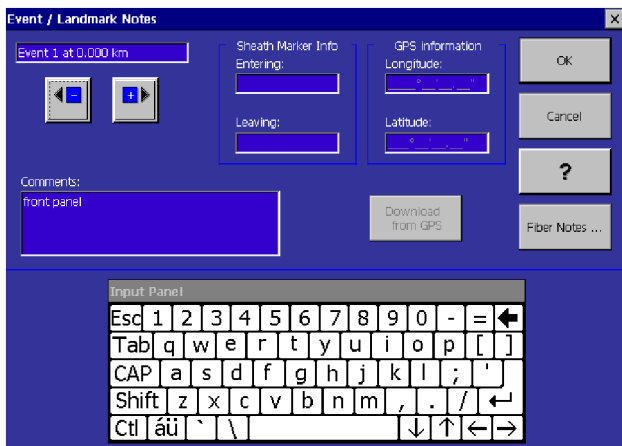

Use the buttons to jump to the event or landmark marker for which you want to examine or edit the notes.

Any comments you enter in the Comments box will be visible from the Event Table Only view.

Use Sheath Marker Info to record the sheath distance (as opposed to the fiber distance) between events or landmarks. Enter the number you read on the sheath cable at the event or landmark.

Enter GPS (Global Positioning System) information into the Longitude: and Latitude: text boxes. GPS coordinates will help you easily locate an event or landmark again.

If you have installed a standard GPS module with RS232 communication, you can press the Download from GPS button to automatically enter the data.

NOTE. *Remember that the GPS will enter the coordinates of the module location at the time you press this button. If you are not standing at the site of the landmark, enter the coordinates by hand or return to the site to enter them automatically.*

You can manually enter GPS coordinates using the following format:

Longitude: Wddd°mm'ss"

Latitude: Ndd°mm'ss"

Where:

dd = latitude degrees [0-90]

ddd = longitude degrees [0-180]

mm = minutes [0-59]

ss = seconds [0-59]

N = n = North latitude (may be replaced with S for South)

W = w = West longitude (may be replaced with E for East)

Fiber Notes Dialog Box

Select **File > Fiber Notes....**

Fiber notes are saved with your trace file. Use the Fiber Notes dialog box to record information in the way that your company finds most useful. The most recently entered descriptions will appear in the drop-down menu of each field.

For Cable Code, enter the Telcordia Suggested Optical Cable Code.

Describe the beginning and ending locations of the trace in the Start Location: and Stop Location: fields.

For Data Flags, the following codes are recommended:

- BC - as-built condition
- OT - other; describe the condition in the Comments: field
- RC - as-repaired condition

In the Comments field, make note of cable or fiber design or link issues. Describe how the link is used and record any construction or repair issues.

Adding, Moving, and Deleting, Events or Landmarks

From the Events menu, you can add, move, and delete both events and landmarks. You can also access Event/Landmark Notes or freeze events.

Adding Events

Select **Events > Add Events...**



Manually added events will appear in the event table with an asterisk (*).

1. Position the active cursor where you want to add an event.
2. Zoom in.
3. Select **Events > Add Events...**
4. Use the cursor buttons to fine tune the position of the cursor where you want to add an event. Notice that the location of the cursor appears in the Location: field.
5. Tap **Add Event** to add an event.
6. Tap **Event Notes...** to describe the event.
7. Tap the **Close** button.

Moving Events

Select **Events > Moving Events...**

Manually added events will appear in the event table with an asterisk (*).

1. Select an event.
2. Zoom in.
3. Select **Events > Move Events...**
4. Use the cursor buttons to move the cursor where you want to move the selected event. Notice that the selected event and the location of the cursor appear in the Location: field.
5. Tap **Move Event** to move the event.
6. Tap **Event Notes...** to edit the event notes.
7. Tap the **Close** button.

Adding Landmarks

Select **Events > Add Landmarks...**

Add a landmark to help you remember how the trace relates to real locations on the fiber such as a bridge. You can mark places where a failure might be likely to occur in the future.

1. Position the active cursor where you want to add a landmark.
2. Zoom in.
3. Select **Events > Add Landmark...**
4. Use the cursor buttons to fine tune the position of the cursor where you want to add a landmark. Notice that the location of the cursor appears in the Location: field.
5. Tap **Add Event** to add an event.
6. Tap **Landmark Notes...** to describe the landmark.
7. Tap the **Close** button.

Moving Landmarks

Select **Events > Moving Landmarks....**

1. Select a landmark.
2. Zoom in.
3. Select **Events > Move Landmark....**
4. Use the cursor buttons to move the cursor where you want to move the selected landmark. Notice that the selected landmark and the location of the cursor appear in the Location: field.
5. Tap **Move Landmark** to move the landmark.
6. Tap **Landmark Notes...** to edit the landmark notes if you wish.
7. Tap the **Close** button.

Deleting Events

Select **Events > Delete Events....**

1. Select an event.
2. Select **Events > Delete Events....**
3. Tap the **Delete Events** button.
4. Tap the **Close** button.

Deleting Landmarks

Select **Events > Delete Landmarks....**

1. Select a landmark.
2. Select **Events > Delete Landmarks....**
3. Tap the **Delete Landmark** button.
4. Tap the **Close** button.

Deleting All Landmarks

Select **Events > Delete All Landmarks....**

All landmarks will be deleted.

Freezing Events

Select **Events > Freeze Events.**

Consider freezing events if you are testing more than one fiber for which you expect the events to have the same locations.

Freezing events allows you to use the current events as a template for subsequent acquisitions. This means that all of the current events will continue to be displayed as new traces are acquired, regardless of the Event Loss actually found at those distances. Additional events that exceed the thresholds will also be found, displayed, and included in the event table.



Appendices

Appendix A: Specifications

The specifications in this section apply to the NetTek Analyzer OTDR Module, unless otherwise specified. For NetTek Analyzer Platform specifications, refer to the *NetTek Analyzer Platform User Manual*.

All specifications are guaranteed unless labeled “typical”. Typical specifications are provided for your convenience and are not guaranteed.

Table A- 1: NetTek Analyzer OTDR Module characteristics

Module	Fiber type	Wavelengths	Dynamic range ¹	Event dead zone ²	Loss dead zone ²
YM8513	Multimode 62.5/125 GI	850 nm ± 30 nm 1300 nm ± 30 nm	32 dB 34 dB	1 m 2 m	3 m 10 m
YSS1310	Singlemode	1310 nm ± 20 nm	38 dB	2 m	8 m
YSS1315	Singlemode	1310 nm ± 20 nm 1550 nm ± 20 nm	38 dB 36 dB	2 m 2 m	8 m 8 m
YSL1315	Singlemode	1310 nm ± 20 nm 1550 nm ± 20 nm	42 dB 40 dB	2 m 2 m	8 m 8 m
YSL1625	Singlemode	1625 nm ± 20 nm	40 dB	2 m	8 m
YSL1516	Singlemode	1550 nm ± 20 nm 1625 nm ± 20 nm	40 dB 40 dB	2 m 2 m	8 m 8 m
YSU1315	Singlemode	1310 nm ± 20 nm 1550 nm ± 20 nm	44 dB 44 dB	2 m 2 m	8 m 8 m
YSU1625	Singlemode	1625 nm ± 20 nm	44 dB	2 m	8 m

¹ Typical at 23 °C, SNR = 1, 3 minutes averaging, maximum pulse width.

² Typical at 23 °C, -40dB reflectance, 3 minutes averaging, minimum pulse width.

Table A-2: General characteristics

Characteristics	Description
Accuracy	
Distance accuracy	
Zero offset	± 0.5 m
Timebase	± 10 ⁻⁵
Sample spacing	± 0.5 m (± 0.1 m YM8513)
Loss accuracy (linearity)	0.02 dB/dB singlemode; 0.05 dB/dB multimode
Reflectance accuracy	± 2 dB, typical
ORL accuracy	± 4 dB, typical
Vertical parameters	
Vertical scale	0.1 to 10.0 dB/div
Readout resolution	0.001 dB
Reflectance range	-14 to -65 dB singlemode; -35 to -62 dB multimode
Horizontal parameters	
Display range	0 to 320 km
Readout resolution	0.001 m
Measurement points	32,000 standard
Length units	meters, feet, miles, kilofeet, kilometers
Pulse widths	
At 850 nm	5, 10, 20, 50, 100 ns
At 1300 nm	10, 20, 50, 100, 200, 500, 1000 ns
At 1310, 1550, and 1625 nm	10, 20, 50, 100, 200, 500, 1000 ns and 1, 2, 10, 20 µs
Waveform scan parameters	
Loss threshold range	0.01 to 5.00 dB, 0.01 dB increments
Reflectance threshold	-14 to -65 dB, 1 dB increments
Default save file format	Telcordia SOR

Table A-2: General characteristics (Cont.)

Characteristics	Description
Test settings	
Test modes	IntelliTrace, Manual, End of Fiber, Real-time
Number of averages	1024 to 4,194,304, in increments of 1
Refractive index	1.40000 to 1.60000, in increments of 0.00001
Scattering coefficient	-100 dB to -40 dB, in increments of 0.01 dB
Cabling factor	0% to 100%, in 0.1% increments
Zero offset	0 to end of data, in increments of one data point
Absolute thresholds	
Reflectance	-65 to -14 dB, in 1 dB increments
Event loss	0.01 to 5 dB, in 0.01 dB increments
Slope	0.1 to 5 dB/km, in 0.01 dB/km increments
Optical Return Loss (ORL)	1 to 30 dB, in 1 dB increments
End-to-end loss	0.1 dB to 50 dB, in 0.1 dB increments
End-of-fiber	1 to 20 dB, in 1 dB increments
Front panel connection	0.1 to 5 dB, in 0.1 dB increments
Distance units	meters, feet, miles, kilofeet, kilometers
OTDR SOR documentation	
Cable ID	ASCII string
Operator	ASCII string
Originating location	ASCII string
Terminating location	ASCII string
Cable code	ASCII string
Fiber condition	CC, BC, RC, OT
Fiber comments	ASCII string
Event comments	ASCII string
Landmark category code	ASCII string

Table A-2: General characteristics (Cont.)

Characteristics	Description
GPS information	Longitude - 0 to 180 degrees in increments of 1 degree, 0 to 60 minutes in increments of 1 minute, 0 to 60 seconds in increments of 1 second, east or west. Latitude - 0 to 90 degrees in increments of 1 degree, 0 to 60 minutes in increments of 1 minute, 0 to 60 seconds in increments of 1 second, north or south.
Sheath marker # entering landmark	0 to 999,999 in increments of 1
Sheath marker # leaving landmark	0 to 999,999 in increments of 1
Units of sheath marker information	km, feet, miles
Landmark comments	ASCII string

Table A-3: Transportation and storage

Characteristics	Description
Transportation and storage	Transportation and storage applies to the application modules assembled on the Y350C platform and individually.
Packaged product	The packaged product qualifies under the Distribution Transportation Cycle 1, Assurance Level I for packaged products 0-20 lbs.
Recyclability	The product transportation package meets the requirements for recyclability.

Table A-4: Environmental characteristics

Characteristic	Description
Temperature range without disk media installed in disk drives	
Operating	-10 °C to +50 °C (+14 °F to 122 °F)
Nonoperating	-40 °C to +60 °C (-40 °F to +140 °F)
Temperature range with floppy drive installed	
Operating	+5 °C to +50 °C (+41 °F to +122 °F)
Nonoperating	-22 °C to +60 °C (-7 °F to +140 °F)
Temperature range for floppy disk media	
Operating	+10 °C to +50 °C (+50 °F to +122 °F)
Nonoperating	-40 °C to +60 °C (-40 °F to +140 °F)
Temperature range for Li-ion batteries	
Discharge	-10 °C to +50 °C (-14 °F to +122 °F)
Charge	0 °C to +45 °C (+32 °F to +113 °F)
Storage	-40 °C to +50 °C (-40 °F to +122 °F)
Humidity	
Operating	up to +50 °C from 5 to 95% RH non-condensing
Nonoperating	up to +60 °C from 5 to 95% RH non-condensing
Altitude	
Operating	Up to 15,333 ft. (4600 m)
Nonoperating	Up to 50,000 ft. (12,192 m)
Sine vibration	
Operating	One 56 minute sinusoidal sweep at 1.5 g from 10 -500 Hz at 0.1 Octave/Min. sweep rate in each of the 3 major axes with the product operating.
Nonoperating	
Random vibration	

Table A-4: Environmental characteristics (Cont.)

Characteristic	Description
Operating	0.31 GRMS from 5-500 Hz, with power spectral density break-down points as follows: Constant 0.0002 g ² /Hz from 5 to 350 Hz, then falls -3dB/octave to 0.00014 g ² /Hz @500 Hz for 10 minute in each of the 3 major axes. Product continued to operate.
Nonoperating	0.03 g ² /Hz from 10 to 500 Hz.
Mechanical shock, operating	Half Sine Mechanical Shock, 50 g's, 11 msec. duration, 3 drops on each face while operating for a total of 18 shocks. Product continued to operate.
Bench handling, operating	Product raised to 45 degrees with respect to bench top, 4 inch, or to the product's point of balance, whichever occurs first - then dropped freely to the horizontal bench top. Product continued to operate.
Topple, operating	Product placed on rear feet or other surface most likely to result in a topple if bumped. Tip the product over just past the point of balance in a direction that it could be reasonably be toppled and allow the product to fall freely onto a non-resilient hard floor surface. Repeat on other edges and surfaces deemed appropriate. Product continued to operate.
Free-fall drop, operating	Single drop from 30 inches onto each of the 6 faces, and 4 corner edges of the product onto a hard unyielding surface while operating. Floppy Drive Option to meet single drop on base (bottom down) as per Telcordia. Tilt Stand mounted on rear case is optional. Product continued to operate.

Table A-5: Physical characteristics

Characteristic	Description
Dimensions	Height: 234 mm (9.2 in) Width: 190 mm (7.5 in) Depth: 33 mm (1.3 in)
Weight	less than 1.4 kg (less than 3 lbs.)

Table A-6: Miscellaneous characteristics

Characteristic	Description
Recommended calibration interval	2 years

Table A-7: Certifications and compliances

Category	Standards or description																
EC Declaration of Conformity - EMC	<p>Meets intent of Directive 89/336/EEC for Electromagnetic Compatibility. Compliance was demonstrated to the following specifications as listed in the Official Journal of the European Communities:</p> <table border="0"> <tr> <td data-bbox="331 479 526 592">EN 61326</td> <td data-bbox="532 479 937 592">EMC requirements for Class A electrical equipment for measurement, control and laboratory use.¹</td> </tr> <tr> <td data-bbox="331 609 526 673">IEC 61000-4-2</td> <td data-bbox="532 609 937 673">Electrostatic discharge immunity (Performance criterion B)</td> </tr> <tr> <td data-bbox="331 690 526 755">IEC 61000-4-3</td> <td data-bbox="532 690 937 755">RF electromagnetic field immunity (Performance criterion A)</td> </tr> <tr> <td data-bbox="331 787 526 852">IEC 61000-4-4</td> <td data-bbox="532 787 937 852">Electrical fast transient / burst immunity (Performance criterion B)</td> </tr> <tr> <td data-bbox="331 868 526 933">IEC 61000-4-5</td> <td data-bbox="532 868 937 933">Power line surge immunity (Performance criterion B)</td> </tr> <tr> <td data-bbox="331 950 526 1015">IEC 61000-4-6</td> <td data-bbox="532 950 937 1015">Conducted RF immunity (Performance criterion A)</td> </tr> <tr> <td data-bbox="331 1031 526 1096">IEC 61000-4-11</td> <td data-bbox="532 1031 937 1096">Voltage dips and interruptions immunity (Performance criterion B)</td> </tr> <tr> <td data-bbox="331 1112 526 1144">EN 61000-3-2</td> <td data-bbox="532 1112 937 1144">AC power line harmonic emissions</td> </tr> </table>	EN 61326	EMC requirements for Class A electrical equipment for measurement, control and laboratory use. ¹	IEC 61000-4-2	Electrostatic discharge immunity (Performance criterion B)	IEC 61000-4-3	RF electromagnetic field immunity (Performance criterion A)	IEC 61000-4-4	Electrical fast transient / burst immunity (Performance criterion B)	IEC 61000-4-5	Power line surge immunity (Performance criterion B)	IEC 61000-4-6	Conducted RF immunity (Performance criterion A)	IEC 61000-4-11	Voltage dips and interruptions immunity (Performance criterion B)	EN 61000-3-2	AC power line harmonic emissions
EN 61326	EMC requirements for Class A electrical equipment for measurement, control and laboratory use. ¹																
IEC 61000-4-2	Electrostatic discharge immunity (Performance criterion B)																
IEC 61000-4-3	RF electromagnetic field immunity (Performance criterion A)																
IEC 61000-4-4	Electrical fast transient / burst immunity (Performance criterion B)																
IEC 61000-4-5	Power line surge immunity (Performance criterion B)																
IEC 61000-4-6	Conducted RF immunity (Performance criterion A)																
IEC 61000-4-11	Voltage dips and interruptions immunity (Performance criterion B)																
EN 61000-3-2	AC power line harmonic emissions																
Australia / New Zealand Declaration of Conformity - EMC	<p>Complies with EMC provision of Radiocommunications Act per the following standard(s):</p> <table border="0"> <tr> <td data-bbox="331 1209 526 1258">AS/NZS 2064.1/2</td> <td data-bbox="532 1209 937 1258">Industrial, Scientific, and Medical Equipment: 1992</td> </tr> </table>	AS/NZS 2064.1/2	Industrial, Scientific, and Medical Equipment: 1992														
AS/NZS 2064.1/2	Industrial, Scientific, and Medical Equipment: 1992																

Table A-7: Certifications and compliances (cont.)

Category	Standards or description
FCC	Emissions comply with FCC Code of Federal Regulations 47, Part 15, Subpart B, Class A Limits.

¹ Emissions which exceed the levels required by this standard may occur when this equipment is connected to a test object.

Table A-8: Safety compliance

Characteristic	Description
Laser Safety	Per 21 CFR 1040.10 and IEC60825-1 Class I invisible laser products.

Appendix B: User-replaceable Parts, Options, and Accessories

You can order the items listed by part number below. Contact your Tektronix representative or distributor for ordering information. See page xiv for further information on contacting Tektronix.

Table B-1: User-replaceable parts

Part number	Description
200-4564-XX	Optical Port Cover

Table B-2: Connector options

Description	Part number
FC	119-5115-XX
E2000 UCI	119-5164-XX
ST	119-4513-XX
Diamond3.5	119-4558-XX
SC	119-5154-XX

Table B-3: Optional accessories

Part number	Description
015-0684-XX	Penlight Visual Fault Finder
015-0685-XX	Bare Fiber Adapter
015-0686-XX	Bare Fiber Adapter with Cleaver

Table B-4: Standard accessories

Quantity	Part number	Description
1 ea	016-1868-XX	Pouch
1 ea	020-2357-XX	Cleaning kit
1 ea	020-2484-XX	English user manual and OTDR application CD-ROM

Appendix C: Maintenance

This section provides information on the following topics:

- Cleaning
- Transporting the OTDR
- Repackaging for shipment

Cleaning



WARNING. *To protect your eyes from laser exposure, power off the instrument and disconnect the power/charger adapter before beginning any cleaning procedure.*

Although the invisible laser output should not damage your eyes under normal use conditions, during cleaning, you may want to view the optical port or fiber connector closely and for a long duration, possibly using magnification. If the power is off, there will be no laser radiation to be concerned with.



CAUTION. *Do not touch the exposed end of the optical port or fiber connector with anything but a lint-free swab or paper wipe dampened with electronics-grade alcohol.*

Do not use index-matching fluid or gel on the optical port or fiber connector. It may cause contamination and a fatal error message. If index-matching material is used, clean the optical port and fiber connector thoroughly.

Do not use acetone on any optical connectors.

Clean the optical port, the connector adapter, and the test fiber adapter before you connect to them each time. As regular maintenance, clean the exterior of the application module to remove dust or oily build up.

Cleaning the Optical Port

Remove the connector adapter by unscrewing it counterclockwise. Pull the connector adapter off the optical port. When the connector adapter is removed, the optical port is accessible for cleaning.

Dampen a lint-free swab or paper wipe with electronics-grade alcohol. Gently wipe across and around the port a couple of times.

Cleaning the Connector Adapter

1. Blow through both ends of the connector adapter barrel with clean, canned air.
2. Dampen a lint-free pipe cleaner with electronics-grade alcohol. The pipe cleaner absorbent should be about 0.35 cm (0.15 inch) in diameter, and the wire part of the pipe cleaner should be less than 0.1 cm (0.04 inch) in diameter.
3. Gently insert the dampened pipe cleaner into the barrel of the connector adapter. Be careful not to scratch the barrel with the wire while inserting it.
4. Pull the pipe cleaner completely through the barrel only once.

Cleaning the Test Fiber Connector

Dampen a lint-free swab or paper wipe with electronics-grade alcohol. Gently wipe across the end of the fiber connector a couple of times.

Cleaning the Exterior of the Module

Remove accumulated dirt or oily residue with a mild detergent and water solution. Do not immerse the analyzer or use abrasive cleaners.

1. Close all NetTek Analyzer and module connector and battery doors.
2. Install the bus door on the rear of the NetTek Analyzer or instrument module. Review the instructions, *Installing an Instrument Module*, beginning on page 1-2.



CAUTION. *To prevent damage to external surfaces, avoid using chemicals that contain acetone, benzene, toluene, xylene, or similar solvents. Do not use bleach or ammonia solutions for cleaning.*

3. Use a soft cloth dampened with a solution of water and mild detergent to clean the instrument.

Transporting the OTDR

The safest way to transport your OTDR is inside a factory-designed carrying case.

Soft Case (standard accessory with the NetTek Analyzer)

1. Put the analyzer and module in the plastic bag to protect it from abrasion during shipping.
2. Place the analyzer and module in the foam cutout.
3. Restrain the analyzer and module with the built-in strap.
4. Close the case and secure the latch.

Hard Cases (optional accessories with the NetTek Analyzer)

1. Put the analyzer and module in the plastic bag to protect it from abrasion during shipping.
2. Place the analyzer and module in the foam cutout.
3. Close the case and secure the latch.

Repackaging for Shipment

To ship the OTDR for repair, use the original packing container if possible. If the container is unfit for use or not available, use the metal carrying case or repackage the instrument as follows:

1. Use a carton with a test strength of no less than 80 kg (175 lbs).
2. Surround the instrument with protective polyethylene sheeting.
3. Cushion the instrument on all sides with at least two inches of tightly packed urethane foam or other packing material.
4. Seal the carton with shipping tape or an industrial stapler.

Appendix D: Installing an OTDR Software Upgrade

You can reinstall or upgrade the OTDR module software using a serial cable to connect to the NetTek Analyzer Platform, or you can upgrade from a PC memory card using the Module Upgrade utility on the NetTek Analyzer Platform.

To upgrade or reinstall the OTDR application software:

1. Insert the NetTek Analyzer OTDR CD-ROM into the PC.
2. Follow the on-screen instructions that appear.
3. If no instructions appear after you insert the CD-ROM, use Windows Explorer to display the contents of the CD-ROM and double-click the **OTDR_install.htm** file or open the file with a web browser. Follow the instructions that appear.



Glossary

Glossary

Attenuation

The loss of optical signal power expressed in decibels.

Attenuation Coefficient

The attenuation of an optical fiber per unit length, typically expressed in dB/km.

Averaging

The number of times a trace is acquired and mathematically combined with previous tests to improve the resolution of low-loss features. Averaging increases the measurement accuracy and range.

Backscatter

The gently sloping part of the trace. Tiny imperfections in the fiber material cause a small, constant amount of light to reflect back to the OTDR over the whole distance of the fiber. See illustration.

Backscatter Coefficient

A specification from the fiber manufacturer for the amount of light reflected per distance of fiber. This parameter is used in OTDR reflectance calculations. If you do not know the correct backscatter coefficient, use the OTDR factory-default values.

Cabling Factor

The percent of extra fiber in the sheath of the cable. Because of the spiral wrap of the cable and snaking (side-to-side variations inside the cable sheath), the physical length of the fiber differs from the sheath length. The cabling factor is the percentage of difference between the two. This allows you to match up the OTDR readings (fiber length) with the printed sheath markings.

Echo Event

Marked with an “e” in the event table. An event caused by reflections off of reflective events in the fiber, usually

mechanical connectors and the end of the fiber. These reflections create an echo of the real event at a distance that is a multiple of the real event. For example, if there is a strong reflection at 2 km, you might see an echo at 4 km. The OTDR identifies echoes and marks them, but it does not remove them because there could be a real connector. In the example, you might really have a connector a 4km. Pure echoes tend to have little or no loss. On shorter fibers with more reflective end connectors you might also see an echo of the entire fiber past the end.

Event

A square marker on the trace to indicate a change in fiber characteristics that exceeds the preset tolerance. Events can be marked by the OTDR or by the operator. See Reflective Event and Non-reflective Event.

Event Dead Zone

The minimum distance after an event that the OTDR can accurately measure the distance to the next event. See *Loss dead zone*.

Event Threshold

The minimum or maximum change in value before the OTDR indicates an event.

GPS

Global Positioning System. A navigational system which determines latitude and longitude coordinates from satellite signals.

Grouped Events

Marked with a “g” in the event table. Events located close enough together so that the OTDR analysis software can recognize that there are multiple events, but cannot measure the loss separately. Grouped events are wider apart than the event dead zone, but closer together than the loss dead zone. The OTDR will show the different distances for the multiple events, but only one loss measurement.

Landmark

A house-shaped marker on the trace that indicates a geographical location. Landmarks are added by the operator.

Laser

Acronym for Light Amplification by Stimulated Emission of Radiation. A device that produces an intense beam of light of a specific wavelength.

Link Loss

The power loss from the front panel to the end of the fiber. When the trace is visible, the link loss readout appears to the right of the event table data.

Loss

A decrease in the power measured by the OTDR between two points on the trace.

Loss dead zone

The minimum distance after an event where the OTDR can measure the loss of the next event as a distinct event. See *Event dead zone*.

Macrobends

A flexed fiber where the radius of the bend is greater than the core size of the fiber.

Microbends

A flexed fiber where the radius of the bend is less than the core size of the fiber.

Multimode fiber

An optical fiber that supports propagation of more than one bound mode.

Non-reflective Event

A point on the trace where the power level of the backscatter suddenly decreases. Caused by a break in the fiber, a fusion splice, a bend, or an unpolished end of the fiber. See *Reflective Event*.

Optical Fiber

A filament of transparent dielectric material, usually glass or plastic, and usually circular in cross section, that guides light. An optical fiber usually has a cylindrical core surrounded by, and in intimate contact with, a cladding of similar geometry. The refractive index of the core must be slightly higher than that of the cladding for the light to be guided by the fiber.

OTDR

Optical Time Domain Reflectometer; an optoelectronic device used to characterize an optical fiber. An OTDR injects a series of light pulses into the fiber under test. It then extracts, from the sending end of the fiber, light that is scattered and reflected back to the source. The intensity of the return pulses is measured and integrated as a function of time, and is plotted as a function of fiber length. An OTDR can tell you the length of a fiber, its overall attenuation, and the location and nature of faults in the fiber.

Pulse Width

The duration in time (ns) that the laser pulses the fiber. Longer pulse widths provide greater range; shorter pulse widths provide shorter loss dead zones between events.

Reflectance

Reflectance (or return loss) is defined as the ratio of returned power to input power, in dB. Typical values are -20 dB (large reflectance) to -50 dB (small reflectance).

Reflective Event

A point on the trace where the reflected power level suddenly raises above the backscatter. Caused by connectors, splices, or the end of the fiber. See *Non-reflective Event*.

Refractive Index

A specification of the fiber. The ratio of the speed of light in a vacuum to the speed of light in the fiber. Affects the OTDR distance measurements.

Singlemode fiber

An optical fiber that permits only the lowest order bound mode to propagate at the wavelength of interest.

Splice

The joining of two separate optical fibers. Splices can be mechanical (connectors) or fusion (melted).

Splice Loss

Any loss of optical power at a splice. A typical splice of optical fibers has losses for a number of reasons. Some losses are due to the fiber properties and others are due to the method or device used to make the splice.

Wavelength

A specification describing the type of light (the distance between two crests or troughs in a light wave), produced by the laser in the OTDR. The best wavelength to use for testing an optical system is generally the system's operating wavelength. However, sometimes 1625 nm is used to measure active systems because it is outside the band used for communication.



Index

Index

A

- About Trace, 2-36
- Accelerator keys, operating with a keyboard, 3-20
- Accessories
 - optional, B-2
 - standard, B-2
- Adapter
 - installation of, 1-9
 - removal of, 1-10
- Adding
 - events, 3-26
 - landmarks, 3-28
- Address, Tektronix, xiv
- Analysis, basic tutorial, 2-16
- Asterisk, 2-14
- Attenuation, Glossary-1
- Attenuation coefficient, Glossary-1
- Auto Test and Save, 3-12
- Averaging, 2-24, Glossary-1
 - acquisition without. *See* Real Time test mode

B

- Backscatter, Glossary-1
- Backscatter coefficient
 - definition, Glossary-1
 - setting the, 2-26
- Basic tutorial, 2-15
- Bend, macro or micro, Glossary-3
- Bidirectional Averages measurement, 3-9
- BuiltInDisk, 2-30
- Bus door, 1-3

Buttons

- cursor, 2-11
- help, 2-2
- main screen, 2-4
- refresh, 2-4
- Run Settings, 2-4
- soft keypad, 2-5
- Trace Settings, 2-5
- zoom sizing, 2-9

C

- Cabling factor
 - definition, Glossary-1
 - setting the, 2-26
- Calibration interval, A-7
- Certifications, A-8
- CFR file type, 3-22
- Cleaning instructions, C-1
- Closing the optical port, 1-7
- Compare two traces, 3-8
- Configuring settings, 2-21
- Connector adapter
 - installation, 1-9
 - removal, 1-10
- Connector options, standard, B-1
- Contacting Tektronix, xiv
- Conventions, xii
- Coordinates, GPS, 3-23
- Copy buttons, 2-28
- Cover
 - bus, 1-3
 - optical port, 1-8, B-1
- Cumulative Loss, 2-13
- Cursor buttons, 2-4

Cursors, 2-11
 join , 3-21

D

Dead zone
 event, Glossary-2
 loss, Glossary-3
Deleting
 events, 3-29
 landmarks, 3-30
Delta readouts, showing or hiding,
 2-6
Difference measurement, 3-11
Dimensions, A-7
Display Overview Window, 2-7
Distance columns, event table,
 2-13
Distance Units, setting the, 3-21
Documentation conventions, xii
Documentation set, xiii
Documenting fibers, events, and
 landmarks, 3-23
Door
 instrument module bus, 1-3
 optical port, 1-8, B-1
Dual Trace Mode, 3-8

E

e, 2-14
Echo event, Glossary-1
End, 2-14
 multiple events marked as, 3-17
End Detection, setting the, 2-24
End of Fiber
 basic tutorial, 2-18
 test mode, 2-25

English units. *See* Distance Units,
 setting the
Event, Glossary-2
 dead zone, Glossary-2
 non-reflective, Glossary-3
 number, 2-13
 reflective, Glossary-4
 showing or hiding markers, 2-6
Event / Landmark Notes, 2-13,
 3-23
Event Loss
 measurement, 3-2
 setting the threshold, 2-27
Event Loss Limit, 2-26
Event table
 column definitions, 2-12
 symbols and highlights, 2-14
Event threshold, Glossary-2
Events, freezing, 3-30
Events and landmarks, adding,
 moving, and deleting, 3-26
Extensions, 3-22

F

Factory Defaults, 3-21
Feet, 3-21
Fiber Notes, 3-25
Fiber, optical, Glossary-4
FiberMaster files, 3-22
File types, 3-22
Find information, start Help, 2-1
Flagging events and link loss. *See*
 Limits
FMTAP files, 3-22
Formats, file types, 3-22
Freezing events, 3-30

Front Panel Loss Warning, setting
the, 3-21

G

g, 2-14

GPS

definition, Glossary-2

entering coordinates, 3-23

Grid lines, show or hide, 2-6

Grouped events

definition, Glossary-2

marked as end, 3-17

H

Help, find information, 2-1

Help buttons, 2-2

Hide or show main screen items

delta readouts, 2-6

event markers, 2-6

event table columns, 2-12

grid lines, 2-6

Input Panel, 2-1

refresh button, 2-4

restoring the zoom box, 2-9

settings panel, 2-5

trace or table, 2-5

when printing, 3-19

zoom scroll bars, 2-10

Highlighting out-of-limit data,
2-26

Highlights and symbols, event
table, 2-14

Hot keys, operating with a key-
board, 3-20

I

Icons. *See* Buttons

Higher resolution, multimode tests,
3-18

Increasing resolution, multimode
tests, 3-18

Increasing the range, 3-16

Information, getting help, 2-1

Input Panel, opening and closing,
2-1

Installation

connector adapter, 1-9

instrument module, 1-2

Installing the OTDR module soft-
ware, D-1

IntelliTrace Plus

special optimizations, 2-25

test mode, 2-25

J

Join Cursors, 3-21

K

Keyboard, operating the OTDR
with, 3-20

Keypad, opening and closing the
Input Panel, 2-1, 2-2

L

L, 2-14

Landmark, Glossary-3

Landmarks and events
 adding, moving, and deleting,
 3-26
 making notes, 3-23
 viewing notes in the event table,
 2-13

Laser
 definition, Glossary-3
 optical port location, 1-7

Latitude and longitude, 3-23

Length of the fiber
 basic tutorial, 2-18
 End of Fiber test mode. *See*
 Empty

Limits, 2-26

Link loss, Glossary-3

Link Loss Limit, 2-26

Locking events. *See* Freezing
 events

Loss, 2-13, Glossary-3

Loss dead zone, Glossary-3

Loss delta, 2-13

LSA Slope, advanced calculations,
 3-5

M

Macro bends, Glossary-3

Main screen
 buttons, 2-4
 elements, 2-3

Maintenance, C-1

Manual conventions, xii

Manual test mode, 2-25

Markers, show or hide, 2-6

Maximizing the help screen, 2-2

Measurements, 3-1
 Bidirectional Averages, 3-9
 Difference, 3-11
 Event Loss, 3-2

 ORL (Optical Return Loss), 3-7
 Reflectance, 3-6
 basic tutorial, 2-15
 Two Point, 3-4

Meters, 3-21

Microbend, Glossary-3

Miles, 3-21

Moving
 events, 3-27
 landmarks, 3-29

Multimode fiber, Glossary-3

Multimode sample file, 2-47

Multimode tests, higher resolution,
 3-18

N

NetTek Analyzer documentation,
 xiii

No averaging. *See* Real Time test
 mode

Nomenclature, xi

Non-reflective event, Glossary-3

Notes, 3-23

O

Opening files, 2-33

Optical connector, stowing, 1-7

Optical fiber, Glossary-4

ORL (Optical Return Loss) mea-
 surement, 3-7

OTDR, Glossary-4

OTDR types, xi

Out of Range, 2-14

Out of Range, 3-16

Out-of-limit data, highlighting. *See*
 Limits

Overview window, 2-7

P

Packaging for shipment, C-5
Phone number, Tektronix, xiv
Platform documentation, xiii
Power-On Settings, setting the,
3-21
Printing, 3-19
Product support, contact informa-
tion, xiv
Products, xi
Pulse width, 2-24, Glossary-4

R

Range
 increasing the, 3-16
 setting the, 2-24
Readouts, show or hide, 2-6
Real Time test mode, 2-25
Recording fiber, event, and land-
mark notes, 3-23
Red highlighting, 2-14
Reflectance, 2-13, Glossary-4
Reflectance Limit, 2-26
Reflectance measurement, 3-6
Reflectance Threshold, setting the,
2-27
Reflective event, Glossary-4
Refractive index
 definition, Glossary-4
 setting the, 2-26
Refresh the screen, 2-4
Related documentation, xiii
Related products, xii
Removal
 connector adapter, 1-10
 instrument module, 1-6
Resolution, multimode tests, 3-18
Restore Zoom Box, 2-9

Run tabs, 2-21

S

Sales support, contact information,
xiv
Sample files, 2-37
 Test-MM.SOR, 2-47
 Test1.SOR, 2-38
 Test2.SOR, 2-46
Saving, 2-29
 information saved with a test,
 2-29
 settings only, 2-31
Screen proportions, trace and table
regions, 2-5
Service support, contact informa-
tion, xiv
SET file type, 3-22
Settings, 2-21
 copying to other tabs, 2-28
 factory defaults, 3-21
 information from a saved trace,
 2-36
 opening .SET files, 2-33
 saving .SET files, 2-31
 limits, 2-26
 test settings, 2-21
 thresholds, 2-27
Sheath marker information, 3-23
Shipping, how to package, C-5
Show or hide main screen items
 delta readouts, 2-6
 event markers, 2-6
 event table columns, 2-12
 grid lines, 2-6
 Input Panel, 2-1
 refresh button, 2-4
 restoring the zoom box, 2-9
 settings panel, 2-5

- trace or table, 2-5
 - when printing, 3-19
 - zoom scroll bars, 2-10
- Singlemode fiber, definition, Glossary-5
- Singlemode sample file, 2-38, 2-46
- Sizing the zoom box, 2-9
- Slope, 2-13
- Slope Limit, 2-26
- Software, version, xi
- Software upgrade, D-1
- SOR file type, 3-22
- Specifications, A-1
- Splice, Glossary-5
- Splice loss, Glossary-5
- Symbols and highlights, event table, 2-14
- System Factory Defaults, 3-21

T

- Table
 - column definitions, 2-12
 - symbols and highlights, 2-14
- TARGET1 files, 3-22
- Technical support, contact information, xiv
- Tektronix, contacting, xiv
- Telcordia format, 3-22
- Test Mode, 2-24, 2-25
- Test settings, 2-21
- Test time, 2-24
- Test-MM.SOR, 2-47
- Test1.SOR, 2-38
- Test2.SOR, 2-46
- TFP2 FiberMaster files, 3-22
- TFP2A files, 3-22
- TFS3031 files, 3-22

- Third tab
 - Bidirectional Averages, 3-9
 - Difference measurements, 3-11
- Thresholds, setting, 2-27
- Thumb screw, 1-5
- Trace display options, 2-6
- Trace tabs, 2-21
- Transporting the OTDR, C-4
- Tutorial, 2-15
- Two Point Loss, basic tutorial, 2-18
- Two Point measurement, 3-4
- Two Point Slope, advanced calculations, 3-5

U

- Units of distance, 3-21
- Update the screen, 2-4
- Upgrading the OTDR module software, D-1
- URL, Tektronix, xiv

V

- Version, software/hardware, xi
- Viewing the trace and table, 2-5

W

- Wavelength, Glossary-5
 - setting the, 2-24
- Wavelength choice tradeoffs, multimode tests, 3-18
- Web site address, Tektronix, xiv
- Weight, A-7
- WFM file type, 3-22

Y

Yellow highlighting, 2-14

Z

Zero Reference, setting the, 2-26

Zoom Scroll Bars, 2-10

Zooming, 2-7

 moving the zoomed view, 2-10

 restoring the zoom box, 2-9

 sizing the zoom box, 2-9

