

INSTRUCTION MANUAL

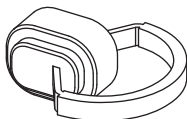

Español.....	13
Français.....	25

521A Wire and Valve Locator

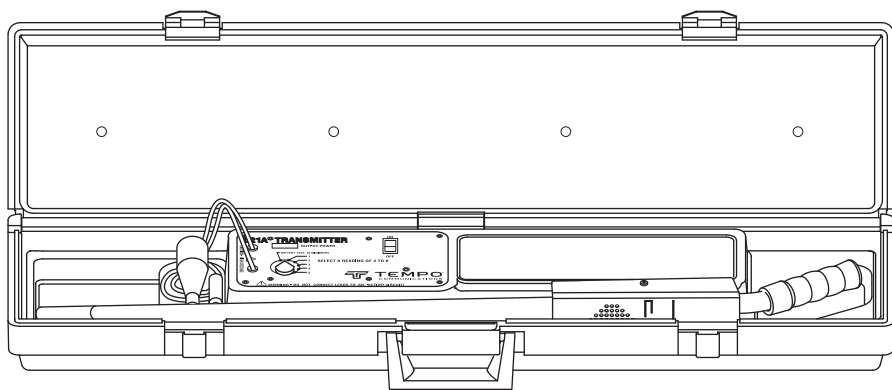

Read and understand all of the instructions and safety information in this manual before operating or servicing this tool.

Contents

Description	2
Safety	2
Purpose of This Manual	2
Important Safety Information.....	3-4
Identification.....	5
Setup.....	6
Operation.....	7-10
Specifications.....	11
Maintenance.....	11

Description

Tempo's 521A Wire and Valve Locator is a universal troubleshooting and maintenance tool for electrically controlled sprinkler irrigation systems. It is capable of locating the wire path, depth, wire breaks, large nicks, and solenoid valves.

Safety

Safety is essential in the use and maintenance of Tempo tools and equipment. This instruction manual and any markings on the tool provide information for avoiding hazards and unsafe practices related to the use of this tool. Observe all of the safety information provided.

Purpose of This Manual

This instruction manual is intended to familiarize all personnel with the safe operation and maintenance procedures for the Tempo 521A Wire and Valve Locator.

Keep this manual available to all personnel. Replacement manuals are available upon request at no charge at www.TempoCom.com.

All specifications are nominal and may change as design improvements occur. Tempo Tools, Inc. shall not be liable for damages resulting from misapplication or misuse of its products.

KEEP THIS MANUAL

Important Safety Information



SAFETY ALERT SYMBOL

This symbol is used to call your attention to hazards or unsafe practices which could result in an injury or property damage. The signal word, defined below, indicates the severity of the hazard. The message after the signal word provides information for preventing or avoiding the hazard.

⚠ DANGER

Immediate hazards which, if not avoided, WILL result in severe injury or death.

⚠ WARNING

Hazards which, if not avoided, COULD result in severe injury or death.

⚠ CAUTION

Hazards or unsafe practices which, if not avoided, MAY result in injury or property damage.



⚠ WARNING

Read and understand this material before operating or servicing this equipment. Failure to understand how to safely operate this tool could result in an accident causing serious injury or death.



⚠ WARNING

Electric shock hazard:
Contact with live circuits could result in severe injury or death.

Important Safety Information

WARNING

Electric shock hazard:

- Do not expose this unit to rain or moisture.
- Use this unit for the manufacturer's intended purpose only, as described in this manual. Any other use can impair the protection provided by the unit.
- Use test leads or accessories that are appropriate for the application. Refer to the category and voltage rating of the test lead or accessory.
- Inspect the test leads or accessory before use. They must be clean and dry, and the insulation must be in good condition.
- Before removing the case or battery cover, remove the test leads from the circuit and shut off the unit.

Failure to observe these warnings could result in severe injury or death.

CAUTION

Electric shock hazard:

Do not connect transmitter to any active AC circuits over 120 VAC.

Failure to observe this precaution may result in injury and can damage the instrument.

CAUTION

Electric shock hazard:

Do not attempt to repair this unit. It contains no user-serviceable parts.

Failure to observe this precaution may result in injury and can damage the instrument.

Identification

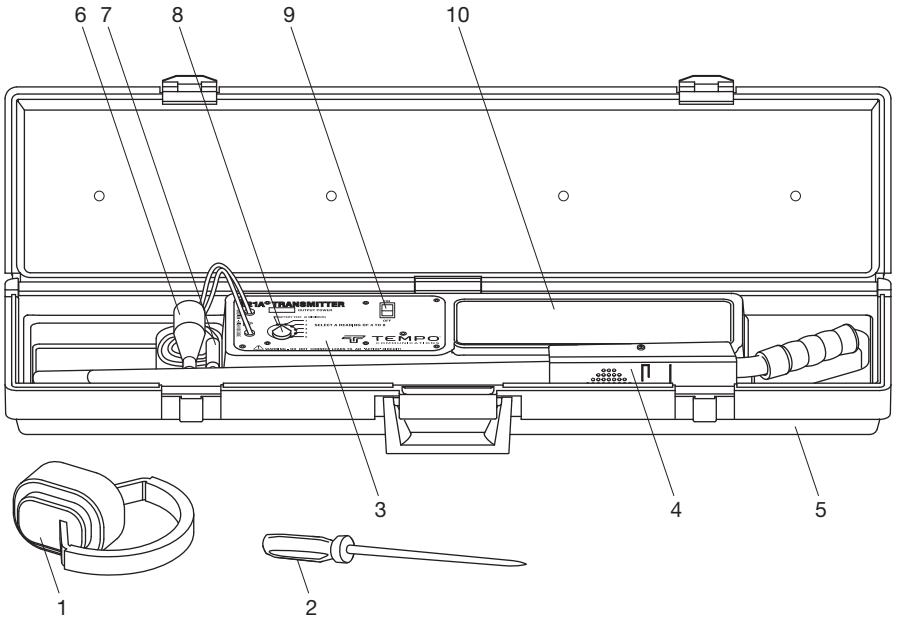

- | | |
|------------------|-------------------|
| 1. Headset | 6. Black lead |
| 2. Ground stake | 7. Red lead |
| 3. Transmitter | 8. Selector knob |
| 4. Receiver | 9. ON/OFF switch |
| 5. Carrying case | 10. Battery cover |

Setup

Note: The transmitter produces high voltage. Turn the transmitter off before handling the output leads. Disconnect all wires from the controller when fault locating. Turn the selector knob to the BATTERY TEST position. The meter should read between 8 and 10.

Before starting, you must ensure the transmitter is set up properly.

IMPORTANT: To ensure that the 521A transmitter is producing optimum signal, connect the red and black leads together and turn the unit on. Turn the selector knob to position #5. The meter needle should rise to at least a 10 reading. If the meter reads below 10 and the batteries are known to be good, return the unit for repair.

⚠ CAUTION

Electric shock hazard:

Do not connect transmitter to any active AC circuits over 120 VAC.

Failure to observe this precaution may result in injury and can damage the instrument.

1. With the transmitter off, connect the red lead to the wire to be located and the black lead to a good earth ground with the stake provided. (Refer to Figure 1.) If the clock is indoors, the earth ground stake **MUST** be grounded at the point where the wires exit the building. It might require running a length of wire to the outside. Do not use a common ground inside (i.e., electrical or water pipe).
2. Now turn the transmitter on and start rotating the selector knob clockwise. Once you leave the BATTERY TEST position and go to #1, the meter needle will fall off to near zero. As you increase the output, the needle will rise slightly with each advancement. Stop when the meter reads between 4 and 8. The transmitter is now set for maximum efficiency for this job. If a reading of 4 is not obtainable, you may not have enough of a ground fault to locate the wire.
3. Plug the optional headset into the receiver if desired, turn it on and point the antenna or probe end at the transmitter. A pulsing tone should be heard through the headset and an indication should register on the receiver meter.

Note: High pitched tones from the headset may occur if the headset cord gets too close to the receiver antenna or the receiver battery is low.

Operation

Locating Wire Path

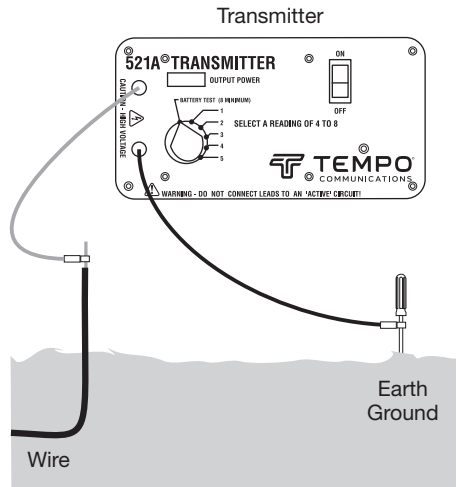

Figure 1 – Transmitter Setup

With the probe pointed toward the ground, walk completely around the transmitter location. An absence of tone or null will be detected directly over the path of the wire. Movement to either side will cause the volume of tone signal intensity to increase. Follow the null to determine the wire path. (Refer to Figure 2.)

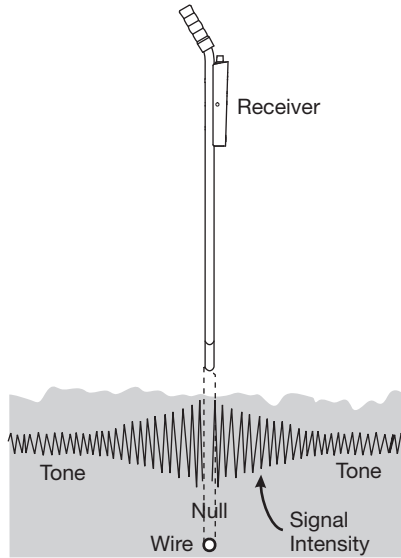

Figure 2 – Locating Wire Path

Finding Wire Breaks and Nicks

When attempting to find breaks and nicks, you should **decrease the sensitivity of the receiver** when pointing it off to either side of the null. You will be able to notice the change in signal intensity immediately. **Do not allow the meter to peg or go above 10.** This will greatly help in the fault locating process.

Note: The wire must have a path to ground to be successfully located. These paths exist in a great majority of all direct buried wires due to insulation imperfections, nicks, and bad splices. If not, create one by grounding the remote end.

- The end of a cut or broken wire can be located by following the path until the null disappears and gives way to a hot spot. Beyond the hot spot, no null can be detected. Back up until the null is detected, and this will be the approximate end of the broken wire. (Refer to Figure 3.)

- Larger nicks in the wire can be located in almost the same way as locating opens. Follow the null and strong signal along the sides of the wire until the signal becomes very weak along the sides of the null. This will occur within a relatively short distance. The transmitted signal bleeds to ground at the nick and then wants to return to the ground stake along the outside of the wire itself. The majority of signals will stop at the nick indicated by the low receiver reading just beyond the nick. (Refer to Figure 4.)
- To more accurately define the location of an open or larger nick (ground fault), position the receiver tip on the ground near the point where the last strong signal was detected along the side of the path. The receiver tip should be pointing at the ground and be approximately 6 inches to either side from the null. Because you are so much closer to the path, the sensitivity knob must be adjusted down until the meter reads just below 10. While maintaining the 6-inch distance from the null, move the receiver down the line, paying close attention to the meter reading. Once you pass the open or nick, the meter will fall off rapidly.

While maintaining the 6-inch distance from the null, move the receiver down the line, paying close attention to the meter reading. Once you pass the open or nick, the meter will fall off rapidly.

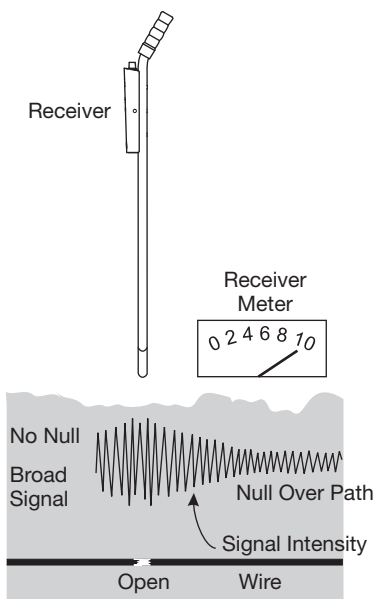

Figure 3 – Locating End of Broken Wire

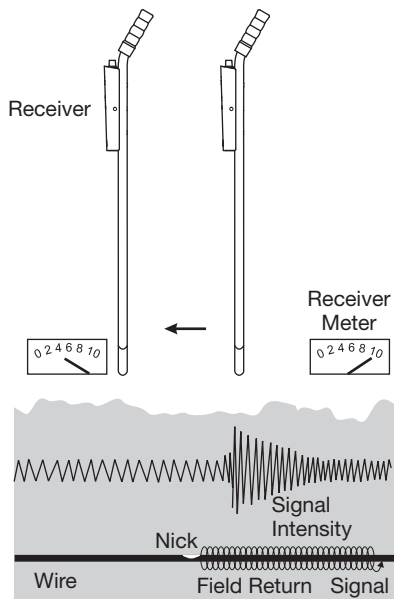

Figure 4 – Locating Wire Nick

Determining Depth of Wire

To determine the depth of the wire, first mark the ground directly over the path. Turn the receiver sideways to the path, and tip it 45 degrees. Move the receiver away from the path, maintaining the 45-degree tip until a null is detected. Mark this spot. The depth is the distance between the two marks. (Refer to Figure 5.)

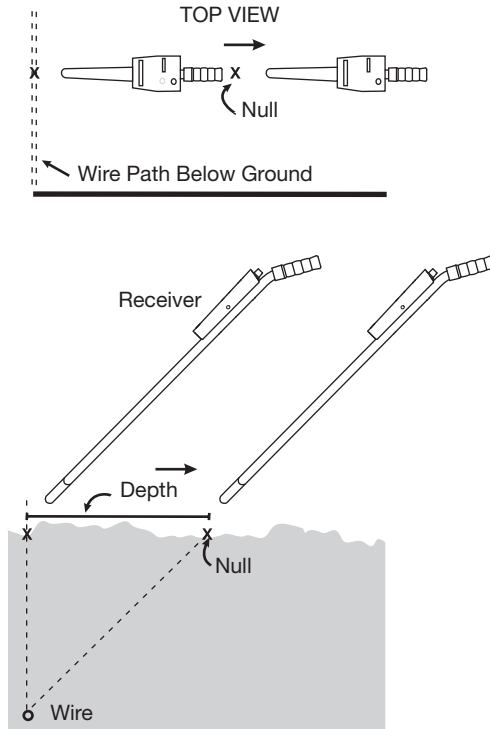

Figure 5 – Determining Depth

Two-Step Solenoid Valve Locating Process

Solenoid valves can easily be located provided all the wires leading to them are intact and the solenoid itself is still good.

Step 1. Start at the clock. Connect the red transmitter lead to the station wire leading to the subject valve, and connect the black lead to earth ground. Turn the transmitter on, adjust the output to the highest level, assemble the receiver, locate the path, and start tracing the wire following the null. The null will be present until you pass over a solenoid valve, and then the signal will become extremely strong. Mark this spot. Check around this hot spot for a null leaving the area. If the null continues, follow it and mark any additional hot spots. (Refer to Figure 6.) If only one hot spot or valve is located, it will be the valve in question.

Step 2. If more than one hot spot is found, mark them and return to the transmitter and turn it off. Lift the black lead from the ground stake and connect it to the common wire. Turn the transmitter on, set the selector knob to the highest reading, and return to the first hot spot with the receiver. Touch the tip of the receiver antenna to the ground in the center of the first hot spot and set the sensitivity knob to read near mid-scale. Now go to the second spot and without touching the sensitivity knob, check the strength of the signal at each hot spot and determine which, out of all of them, is the strongest signal. This is the valve for the station wire you are connected to.

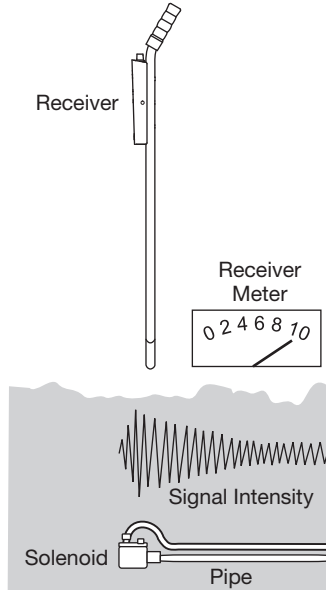

Figure 6 – Locating Broken Wire End

Specifications

Transmitter Frequency: 1748 Hz

Transmitter Power: 750 Vpp, 285 Vrms

Case Dimensions: 851 mm x 210 mm x 95 mm (33.5 in x 8.25 in x 3.75 in)

Battery: Eight D-cells and one 9 V

Battery Life:

Transmitter: 50 hours nominal

Receiver: 100 hours nominal

Automatic Shut-off: 90 minutes for receiver; turn-off bumper for transmitter

Maintenance

WARNING

Electric shock hazard:

Before removing the case or battery cover, remove the test leads from the circuit and shut off the unit.

Failure to observe this warning could result in severe injury or death.

Battery Replacement

1. Turn the unit off.
2. Remove the battery cover.
3. Replace the batteries (observe polarity).
4. Replace the battery cover.

Cleaning

Periodically wipe with a damp cloth and mild detergent; do not use abrasives or solvents.



www.contractoressentials.com.au
www.tmg.com.au

Head Office
TMG Test Equipment
231 Osboun Avenue,
Clayton South
Victoria 3169
1800-680-680

One-Year Limited Warranty

Garantía limitada de un año

Garantie limitée de un an

